

THIS DRAWING IS UNPUBLISHED. RELEASED FOR PUBLICATION
 © COPYRIGHT - BY TYCO ELECTRONICS CORPORATION. ALL RIGHTS RESERVED.

LOC	DIST	REVISIONS					
		P	LTR	DESCRIPTION	DATE	DWN	APVD
H	-		A	RELEASED FOR PRODUCTION	24OCT2016	RK	MvE
			A1	CHANGED LASER MARKING	03NOV2016	RK	MvE

DIMENSIONS BEFORE APPLICATION

NOTES:

- 2213600-1 AS SHOWN.
- MATERIALS:

CONTACT: PHOSPHOR BRONZE, TIN PLATED
 HOUSING: PC NOT GLASS FILLED
 BUTTONS: PC NOT GLASS FILLED

- 3 LASER MARKING:
- (KEMA) PENDING
 - (UL) PENDING
 - TE LOGO
 - TE PART NUMBER
 - DATE CODE

4 LASER MARKING: IP20

5 LASER MARKING: IP x5/x7

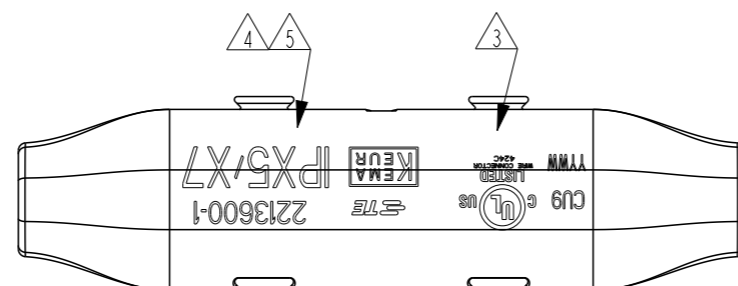
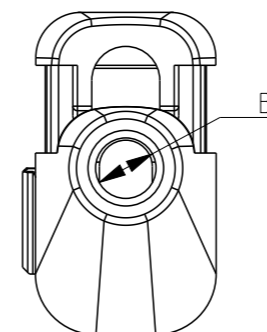
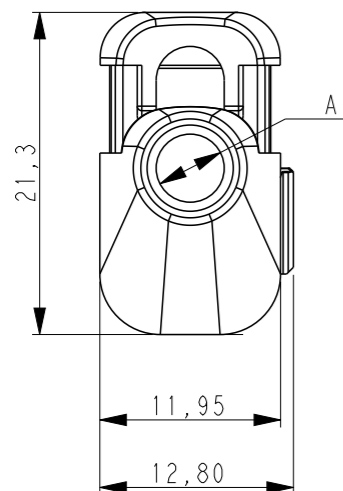
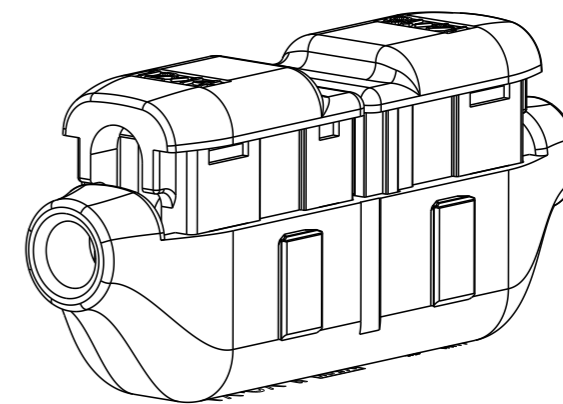
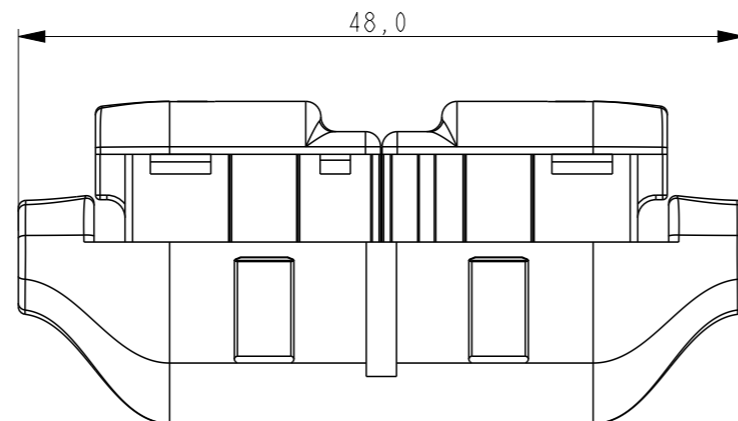
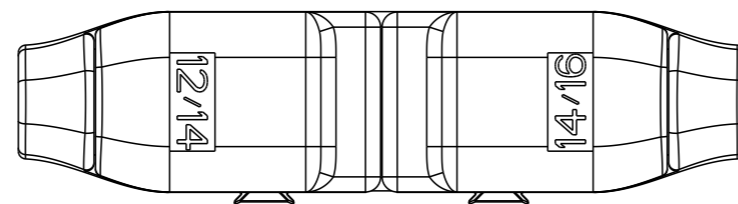

UNSEALED	4	A=4.0 B=3.5	14/16 TO 16/18	BLUE AND RED	CLEAR	2213600-6
UNSEALED	4	A=4.5 B=3.5	12/14 TO 16/18	YELLOW AND RED	CLEAR	2213600-5
UNSEALED	4	A=4.5 B=4.0	12/14 TO 14/16	YELLOW AND BLUE	CLEAR	2213600-4
SEALED	5	A=4.0 B=3.5	14/16 TO 16/18	BLUE AND RED	CLEAR	2213600-3
SEALED	5	A=4.5 B=3.5	12/14 TO 16/18	YELLOW AND RED	CLEAR	2213600-2
SEALED	5	A=4.5 B=4.0	12/14 TO 14/16	YELLOW AND BLUE	CLEAR	2213600-1
SEALING		WIRE ENTRY	WIRE SIZE	BUTTON COLORS	HOUSING COLOR	PART NUMBER

THIS DRAWING IS A CONTROLLED DOCUMENT. DIMENSIONING AND TOLERANCING PER ASME Y14.5M-2009.		DWN M.V.ESSEN 06 NOV'15	 TE Connectivity	
DIMENSIONS: mm		CHK C.V.STEENDEREN		
TOLERANCES UNLESS OTHERWISE SPECIFIED:		APVD O.IEIJNSE	NAME COOL SPLICE ONE POSITION LARGE WIRE GAUGE	
0 PLC ±0,2		PRODUCT SPEC 108-133061	SIZE A3	
1 PLC ±0,2		APPLICATION SPEC 114-133061	CAGE CODE 00779	DRAWING NO C-2213600
2 PLC ±0,2		WEIGHT -	RESTRICTED TO -	
3 PLC ±0,2		CUSTOMER DRAWING	SCALE 2:1	SHEET 1 OF 3
4 PLC ±0,2				REV A1
ANGLES ±0,2				
FINISH -				

THIS DRAWING IS UNPUBLISHED.

RELEASED FOR PUBLICATION

© COPYRIGHT - BY TYCO ELECTRONICS CORPORATION. ALL RIGHTS RESERVED.

LOC	DIST	REVISIONS					
		P	LTR	DESCRIPTION	DATE	DWN	APVD
		-		SEE SHEET 1	-	-	-

DIMENSIONS AFTER APPLICATION

NOTE:
1. 2213600-1 AS SHOWN.

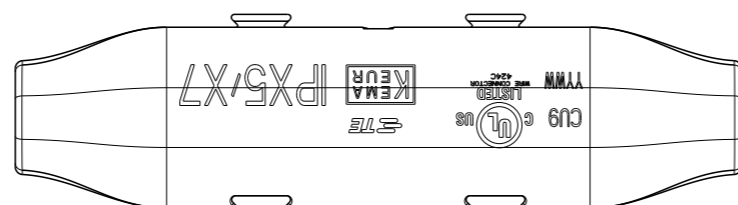
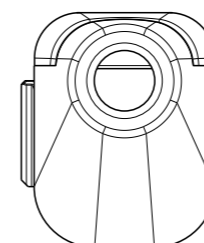
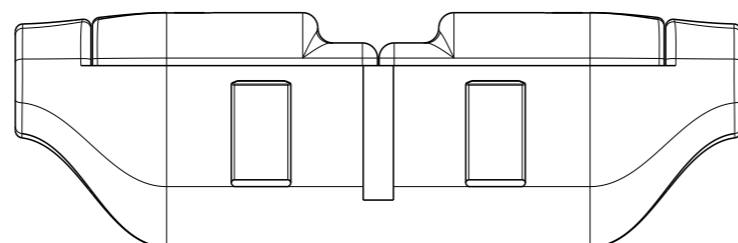
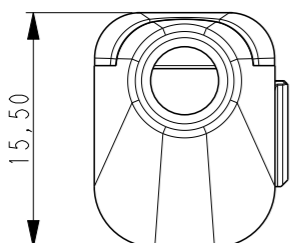
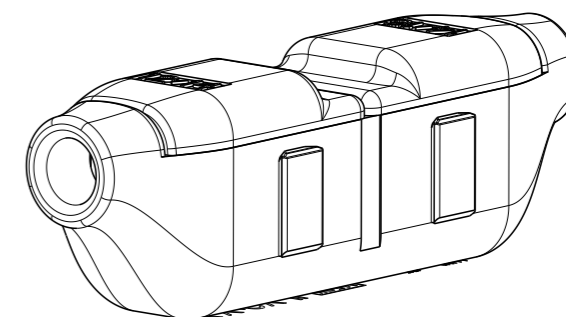
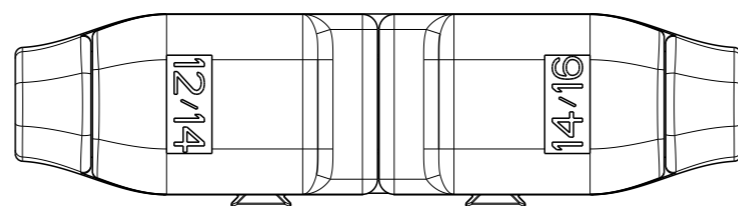

THIS DRAWING IS A CONTROLLED DOCUMENT.		DWN M.V.ESSSEN	06 NOV '15		
DIMENSIONS: mm		CHK C.V.STEENDEREN	-		
TOLERANCES UNLESS OTHERWISE SPECIFIED:		APVD O.IEIJNSE	-	NAME COOL SPLICE ONE POSITION LARGE WIRE GAUGE	
0 PLC ±-		PRODUCT SPEC 108-133061	-	APPLICATION SPEC	
1 PLC ±0,2		APPLICATION SPEC 114-133061	-	SIZE A3	CAGE CODE 00779
2 PLC ±0,2		WEIGHT -	-	DRAWING NO C-2213600	RESTRICTED TO -
3 PLC ±-		CUSTOMER DRAWING		SCALE 1:1	SHEET 2 OF 3
4 PLC ±-				REV A1	
ANGLES ±-					
FINISH -					
MATERIAL -					

THIS DRAWING IS UNPUBLISHED.

RELEASED FOR PUBLICATION

© COPYRIGHT - BY TYCO ELECTRONICS CORPORATION. ALL RIGHTS RESERVED.

LOC	DIST	REVISIONS					
		P	LTR	DESCRIPTION	DATE	DWN	APVD
		-		SEE SHEET 1	-	-	-

DIMENSIONS AFTER STACKING

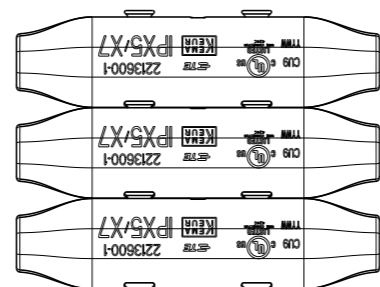
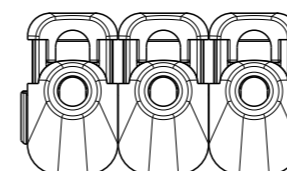
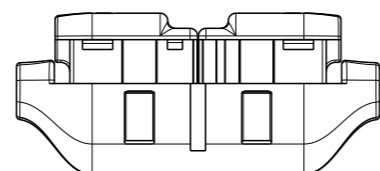
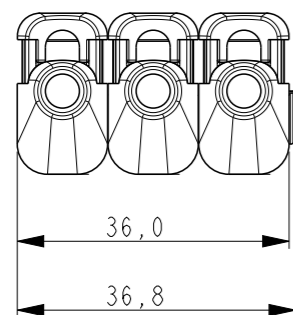
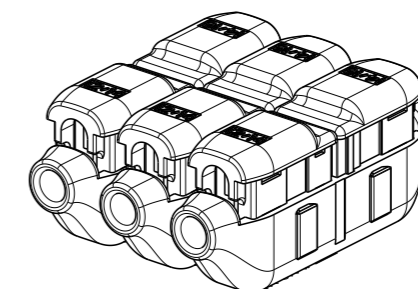
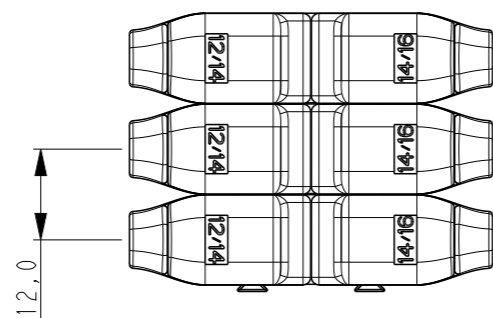

THIS DRAWING IS A CONTROLLED DOCUMENT.		DWN M.V.ESSSEN 06 NOV '15	 TE Connectivity	
DIMENSIONS: mm		CHK C.V.STEENDEREN		
TOLERANCES UNLESS OTHERWISE SPECIFIED:		APVD O.IEIJNSE	NAME COOL SPLICE ONE POSITION LARGE WIRE GAUGE	
<ul style="list-style-type: none"> 0 PLC ±- 1 PLC ±0,2 2 PLC ±0,2 3 PLC ±- 4 PLC ±- ANGLES ±- 		PRODUCT SPEC 108-133061	RESTRICTED TO	
MATERIAL -		FINISH -	APPLICATION SPEC 114-133061	SIZE A3
		WEIGHT -	CAGE CODE 00779	DRAWING NO C-2213600
		CUSTOMER DRAWING	SCALE 1:1	SHEET 3 OF 3
				REV A1