

TNC Connectors, 50 Ohm

Plugs, Crimp

**Hex Crimp and
O Crimp**

**Mil Type
O Crimp
Weatherproof**

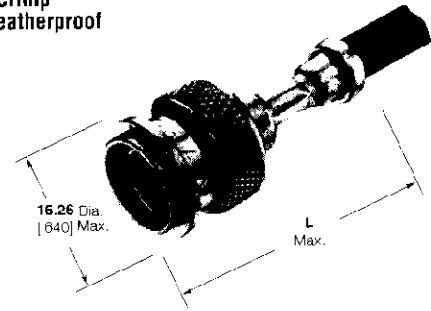
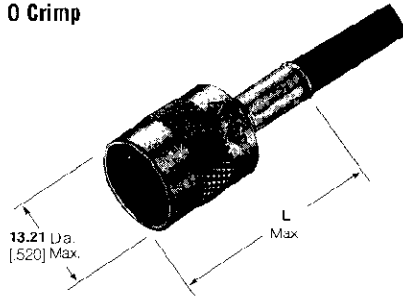

RG/U Cable	Termination Type	Center Contact Plating	Body Plating	Dielectric	Style	Comments	Dim. L	CERTI-CRIMP Hand Tool with Integral Die	Interchangeable Dies for PRO-CRIMPER Hand Tool 354940-1 or PRO-CRIMPER Adapter 679304-1	Interchangeable Dies for Hand Tool 69710-1 & 626 Phau. Head 318161-1	Part No.
174, 188, 188A, 316	Hex Crimp	Gold	Nickel	Polypropylene	Commercial	—	31.24 1.230	—	58436-3	—	222506-5
179, 173A, 179B 161, 167, 167A Belden 9221	Hex Crimp	Gold	Nickel	Polypropylene	Commercial	—	31.24 1.230	—	58436-3	—	222506-5
RC316 188 Double Braid	Hex Crimp	Gold	Nickel	Polypropylene	Commercial	—	31.24 1.230	—	58436-3	—	222506-9
180, 180A, 180B 195, 195A	Hex Crimp	Gold	Nickel	Polypropylene	Commercial	—	31.24 1.230	—	58436-3	—	222506-7
58, 58A, 58B, 58C	Hex Crimp	Gold	Nickel	Polypropylene	Commercial	—	31.25 1.230	—	58436-1 ¹	—	222506-1
	O Crimp	Gold	Silver	TEFLON	Mil Type	—	34.93 1.375	220045-2	—	—	225550-2
	O Crimp	Gold	Nickel	TEFLON	Mil Type	Weatherproof	34.93 1.375	220045-2	—	—	225550-2
58, 58A, 58B, 58C 141, 141A, 3C3	O Crimp	Gold	Nickel	Polypropylene	Commercial	—	26.8 1.055	220187-1	58436-1 ¹	220217-1	227000-5
223, 35, 55A, 55B	Hex Crimp	Gold	Nickel	Polypropylene	Commercial	—	31.24 1.230	—	58436-1	—	1-222506-1
142, 142A 142B, 4C0	Hex Crimp	Gold	Nickel	Polypropylene	Commercial	—	31.24 1.230	—	58436-1	—	222506-4
	O Crimp	Gold	Silver	TEFLON	Mil Type	—	34.29 1.350	220045-2	—	—	225345-6
	O Crimp	Gold	Silver	TEFLON	Mil Type	Weatherproof	34.93 1.375	220045-2	—	—	225550-6
124, 140, 210, 62, 62A, 62E, 59, 59A, 59B Belden 9251, 9209, 9269	Hex Crimp	Gold	Nickel	Polypropylene	Commercial	—	29.72 1.170	—	58436-1	—	222506-2
	O Crimp	Gold	Nickel	Polypropylene	Commercial	—	26.8 1.055	—	58436-1	—	227000-7
	O Crimp	Gold	Nickel	TEFLON	Mil Type	Weatherproof	50.8 2.000	220015-1	—	—	225550-7
Alpha 9847, Belden 821E, 8292	O Crimp	Gold	Silver	TEFLON	Mil Type	Weatherproof	50.88 1.995	220015-1	—	—	1-225550-3
225, 393	O Crimp	Gold	Silver	TEFLON	Mil Type	Weatherproof	50.8 2.000	220015-1	—	—	1-225550-2
	O Crimp	Gold	Silver	TEFLON	Mil Type	—	50.8 2.000	220015-1	—	—	225345-8
9, 9A, 9B, 214	O Crimp	Gold	Silver	TEFLON	Mil Type	Weatherproof	50.8 2.000	220015-1	—	—	225550-8
	O Crimp	Gold	Nickel	TEFLON	Mil Type	Weatherproof	50.8 2.000	220015-1	—	—	225550-8

¹Order AMP PRO-CRIMPER Coaxial "O" Crimp Hand Tool assembly 58433-1, which includes dies 58436-1.
²Order AMP PRO-CRIMPER Coaxial Hex Crimp Hand Tool assembly 58433-2, which includes dies 58436-1.