

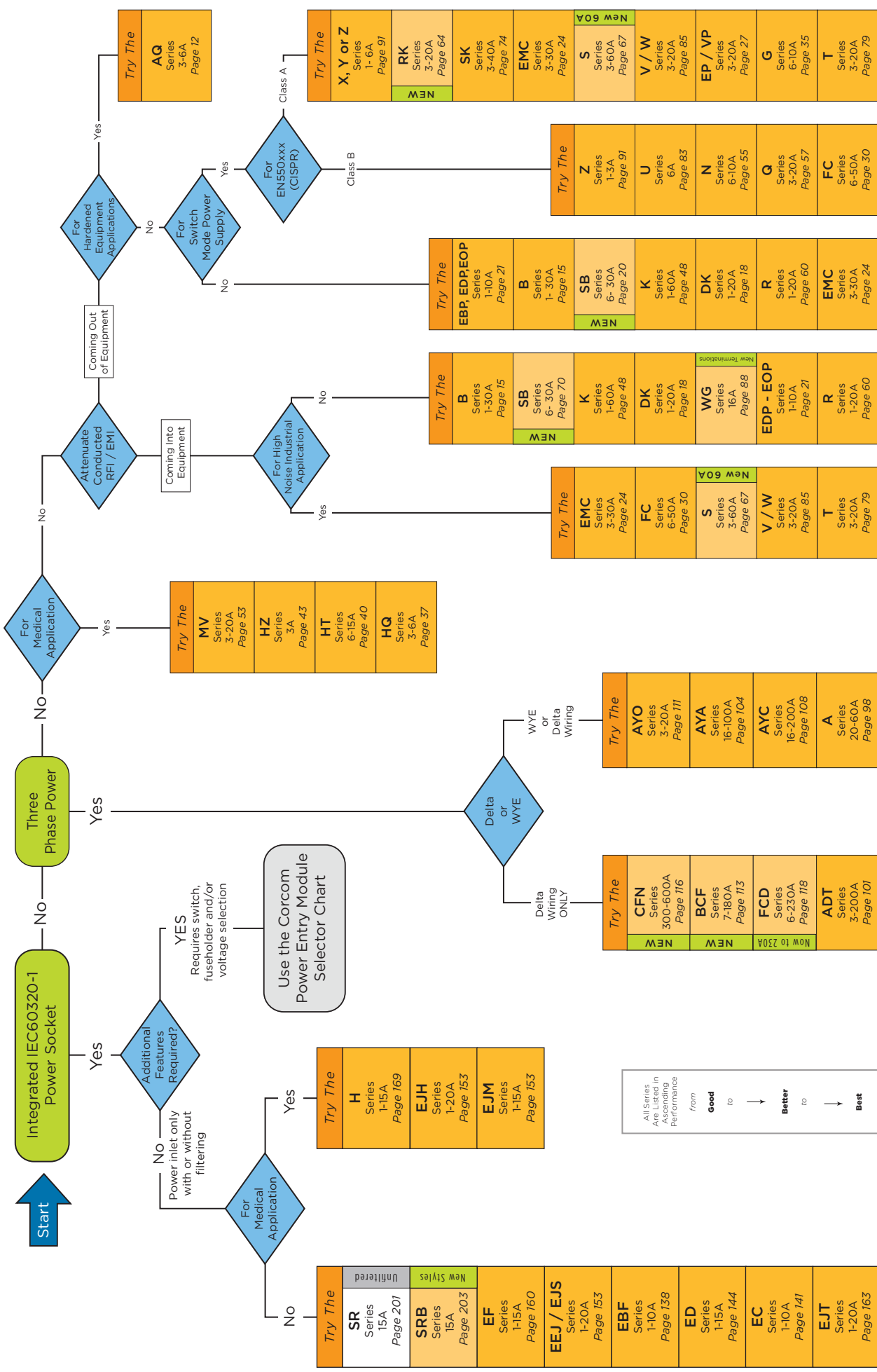























Corcom EMI / RFI Filter Selector Chart



All Series Are Listed in Performance from **Good** to **Better** to **Best**

Corcom Medical Power Line Filter Selector Chart

Series	Current Ratings	Install Type	Termination Types	IEC Inlet	Meets EN60601 3 rd edition	Filter Performance
H 	3, 6, 10, 15 & 20A	Chassis, Flange, Snap-In	Quick Connect & Wire Leads <small>Styles 1, 3, 4, 5, 8 and 9</small>	Yes	✓	Good → Better → Best
EJH 	1, 3, 6, 10, 15, & 20A	Flange, Snap-In	Quick Connect, PC Board, Wire Leads <small>Styles 1, 2, 8, and P</small>	Yes	✓	
EJM 	1, 3, 6, 10, & 15A	Flange, Snap-In	Quick Connect & Wire Leads <small>Styles 1 and 8</small>	Yes	✓	
MV 	3, 6, 10, & 20A	Chassis	Quick Connect <small>Style 1</small>	No	✓	
HZ 	3, 4, 6, 10, 15, 20 & 30A	Chassis	Quick Connect <small>Style 1</small>	No	✓	
HT 	6, 10, 15 & 20A	Chassis, Bulk Head	Quick Connect, Screw, & Wire Leads <small>Styles 1,3, 6 and 7</small>	Optional	✓	
HQ 	3, 6 & 20A	Chassis, Bulk Head	Quick Connect & Wire Leads <small>Styles 1, 3, and 6</small>	Optional	✓	
MRI 	2 x 30A	Bulk Head / Wall Mount <small>Threaded Conduit (Load) & Knockouts (input side)</small>	Wire Leads	No	N/A	

Series	Unfiltered		Filtered				Options		
	Product Photo	Max. Current Rating	Product Photo	Max. Current Rating	Filter Type	On/Off Switch	Voltage Selector	Fuse Holder	
C		15A		10A	Medical & General Purpose	Yes DPST	N/A	N/A	
		NEW							
CU		15A		15A	General Purpose	Yes SPST	N/A	N/A	
		NEW							
GG	Filtered Only			10A	Medical & General Purpose	N/A	N/A	European Style	
L		6A		6A	Medical & General Purpose	Optional	Optional	North American or European Style	
M		6A		6A	Medical, General Purpose & Switch Mode Power Supply	Optional	Optional	North American or European Style	
P		10A		10A	Medical, General Purpose & Switch Mode Power Supply	Optional	Optional	North American or European Style	
			New High Performance in PE and PM Mounting Styles						
SR <i>Unfiltered</i>		20A		15A	General Purpose	N/A	N/A	N/A	
SRB <i>Filtered</i>									

N/A = Not Available

Corcom Medical Power Entry Module Selector Chart

Series	Current Ratings	Meets UL2601	On/Off Switch	Voltage Selector	Fuseholder
C 	1, 3, 6 & 10A	✓	Yes	N/A	N/A
HG 	1, 3, 6 & 10A	✓	N/A	N/A	European
L 	6A	✓	Optional	Optional	North American or European
M 	5A	✓	Optional	Optional	North American or European
P 	3, 6 & 10A	✓	Optional	Optional	North American or European
New High Performance in PE and PM Mounting Styles					