

SCALA NON IMPEGNATIVA (DO NOT SCALE)
 DIMENSIONI IN (DIMENSIONS IN) mm
METRIC
 PROIEZIONE EUROPEA (EUROPEAN PROJECTION)

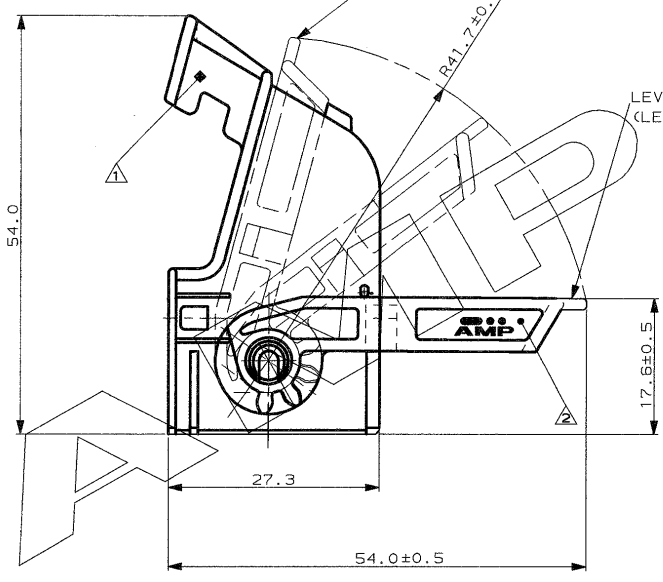
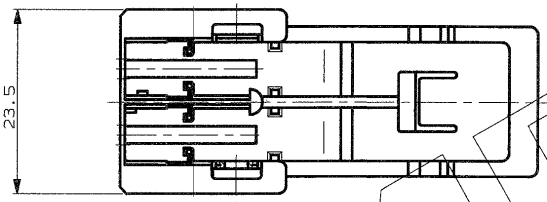
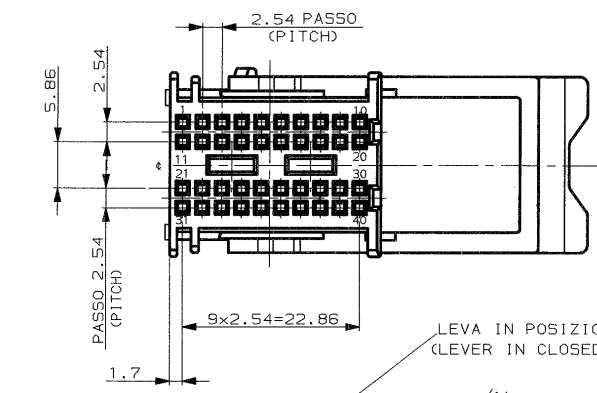

LEVA IN POSIZIONE CHIUSA (LEVER IN CLOSED POSITION)

LEVA IN POSIZIONE APERTA (LEVER IN OPEN POSITION)

NOTE

- 1) CORAZZA 40 VIE IN PAG.6 CARICATO VETRO PER COLORI VEDERE FOGLIO 2/2 (SHELL 40 POS. IN PAG.6 GLASS FILLED FOR COLOR SEE SHEET 2/2)
 - 2) LEVA IN PAG.6 CARICATO VETRO COLORE ROSSO (LEVER IN PAG.6 GLASS FILLED COLOR RED)
 - 3) IL PRODOTTO VIENE FORNITO CON LEVA IN POSIZIONE CHIUSA (THE PRODUCT IS SUPPLIED WITH LEVER IN CLOSED POSITION)
 - 4) N°1 CORAZZA + N°2 BLOCCHETTI SONO FORNITI IN KIT SECONDO TABELLA FOGLIO 2/4 CON PARI NUMERO DI PEZZI PER SCATOLA (N°1 SHELL + N° 2 HOUSINGS ARE SUPPLIED IN KIT ACCORDING TO TABLE SHEET 2 /4 WITH EQUIVALENT NUMBER OF PIECES FOR EACH COMPONENT IN A BOX)
- 1 COME MOSTRATO (-1 AS SHOWN)

REVISIONI
 PRINT 015/2

CUSTOMER DRAWING FOR REFERENCE ONLY				DISEGNO PER CLIENTE SOLO PER RIFERIMENTO			
THIS DRAWING IS UNPUBLISHED				RELEASE FOR PUBLICATION 19			
© COPYRIGHT IS BY AMP INCORPORATED, HARRISBURG, PA. ALL INTERNATIONAL RIGHTS RESERVED. AMP PRODUCTS MAY BE COVERED BY U.S. AND FOREIGN PATENT AND/OR PATENT PENDING.							
TOLLERANZE SE NON DIVERSAMENTE SPECIFICATE (DIMENSIONS UNLESS OTHERWISE SPECIFIED)				MATERIALE (MATERIAL)		INITIURA (INITIALS)	
± 0.3				VEDERE NOTE (SEE NOTES)		VEDERE NOTE (SEE NOTES)	
ANGOLI (ANGLED) ± 0°				AMP AMP ITALIA S.p.A. Corso F.lli. Corvi, 15 COLLEGGIO (TORINO)			
A3	ADDED N. 4 INTERNAL RIBS	G.S. 0155-90	74-96				
A2	RELEASED FOR PRODUCTION	G.S. 0282-99	99-10	CONNECTOR 20+20 POS. 2.54 mm PITCH (KIT)			
A1	AGGIUNTI P/Ns COMPONENTI (ADDED P/Ns OF COMPONENTS)	O.C. 0309-98	1998	C.C. SIZE NUMERO (COW NO)			
A	FIRST ISSUE	O.C. 0272-98	98	REV. FOGLIO (SHEET)			
REV.	REVISIONI (REVISION RECORD)	DIS. (DR)	E.C.N. (DATE)	I A3 C-284229 A3 1 DI 4			

SCALA NON IMPEGNATIVA
(DO NOT SCALE)
DIMENSIONI IN mm
DIMENSIONS IN mm

METRIC

PROIEZIONE EUROPEA
(EUROPEAN PROJECTION)

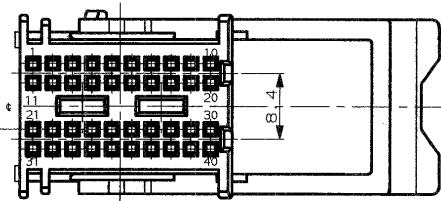
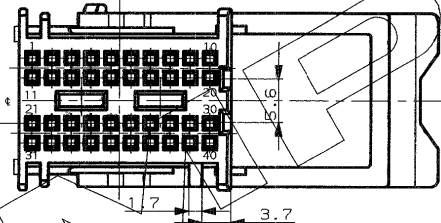
P/N	RAPPRESENTAZIONE GRAFICA DELLE POLARIZZAZIONI (CODING KEY DETAIL)	COLORE (COLOR)	HOUSING CRIMP P/N	CONTROPARTE (COUNTERPART)
284229-1		NERO (BLACK)	VIE 21-40 (POS. 21-40) N°1 COLORE NERO (COLOR BLACK)	97-23135-1
284229-2		BLU (BLUE)	VIE 1-20 (POS. 1-20) N°1 COLORE NATURALE (COLOR NATURAL) VIE 21-40 (POS. 21-40) N°1 COLORE BLU (COLOR BLUE)	97-23135-4

CUSTOMER DRAWING FOR REFERENCE ONLY		DISEGNO PER CLIENTE SOLO PER RIFERIMENTO	
THIS DRAWING IS UNPUBLISHED - RELEASE FOR PUBLICATION 19			
© COPYRIGHT 19 BY AMP INCORPORATED, HARRISBURG, PA. ALL INTERNATIONAL RIGHT RESERVED. AMP PRODUCTS MAY BE COVERED BY U.S. AND FOREIGN PATENT AND/OR PATENT PENDING.			
TOLLERANZE, SE NON DIVERSAMENTE SPECIFICATO	MATERIALE	FINITURA (FINISH)	SCALA (SCALE)
TOLERANCES, UNLESS OTHERWISE SPECIFIED	/	/	4:1
ANGOLI (ANGLES)	AMP ITALIA S.p.A. Corso F.lli. Cavotti, 15 COLLENO (TORINO)		
DIS. O. CANUTO (OR.)	DESCRIZIONE (DESCRIPTION)		
22 SEPT. 98	CONNECTOR 20+20 POS 2.54 mm PITCH (KIT)		
CONT. A. GENTA (CHK)	LOC.	SIZE	NUMERO (DWG NO)
22 SEPT. 98	I	A3	C-284229
APP. A. BRUNI (APP.)	REV.	FOGLIO (SHEET)	
22 SEPT. 98	A3	2 OF 4	
REV. (REV.)	REVISIONI (REVISION RECORD)	DIS. (DR)	E.C.N. (DATE)

DISTRIBUZIONE PERNO 1/16"

VEDERE FOGLIO (SEE SHEET 1/1)

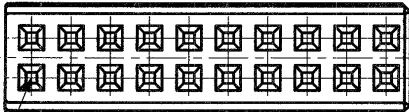

N°20 CAVITA' PER CONTATTI MICRO QUADLOCK P/N 928999-1
 (N°20 CAVITIES FOR MICRO QUADLOCK CONTACT P/N 928999-1)

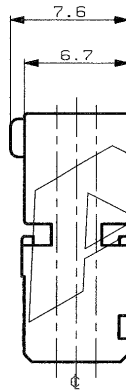
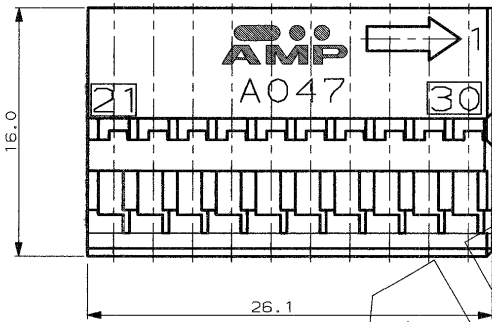

NOTE

⚠ BLOCCHETTO 20 VIE. IN PA.6.6 CARICATO VETRO PER COLORI E POLARIZZAZIONI
 VEDERE FOGLIO 4/4
 (HOUSING 20 POS. IN PA6.6 GLASS FILLED FOR COLOR AND CODINGS SEE SHEET 4/4)

POLARIZZAZIONE NERA COME MOSTRATO
 (BLACK CODING AS SHOWN)

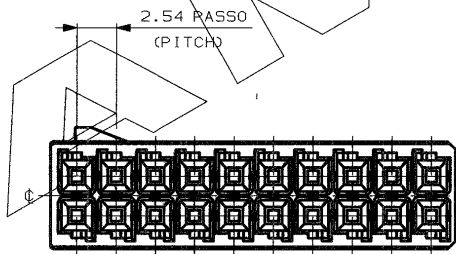

PASSO 2.54 (PITCH)

CUSTOMER DRAWING FOR REFERENCE ONLY		DISEGNO PER CLIENTE SOLO PER RIFERIMENTO	
THIS DRAWING IS UNPUBLISHED- © COPYRIGHT 1998 BY AMP INCORPORATED, HARRISBURG, PA. ALL INTERNATIONAL RIGHTS RESERVED. AMP PRODUCTS MAY BE COVERED BY U.S. AND FOREIGN PATENT AND/OR PATENT PENDING.		RELEASE FOR PUBLICATION 19	
TOLLERANZE, SE NON DIVERSAMENTE SPECIFICATO (TOLERANCES, UNLESS OTHERWISE SPECIFIED)	MATERIALE (MATERIAL)	FINITURA (FINISH)	SCALA (SCALE)
± 0.3	⚠	⚠	4:1
ANGOLI (ANGLES)	AMP AMP ITALIA S.p.A. Corso F.lli Cervi, 15 COLLENO (TORINO)		
DIS. 0, CANUTO (DR.) 22 SEPT.98	DESCRIZIONE (DESCRIPTION) CONNECTOR 20+20 POS. 2.54 mm PITCH (KIT)		
CONT. A. GENTA (CON) 22 SEPT.98	LOC. SIZE NUMERO (LOC. NO.)	REV. FOGLIO (REV. SHEET)	
APP. A. BRUNTI (APP.) 22 SEPT.98	I A3 C-284229	A3 3 DI 4	
REV. REVISIONI (REVISION RECORD)	DIS. (DR)	E.C.N. DATA (DATE)	

VEDERE FOGLIO 1/4
 (SEE SHEET 1/4)

REVISIONI (REVISION RECORD)

SCALA NON IMPEGNATIVA
(DO NOT SCALE)
DIMENSIONI IN
DIMENSIONS IN mm

METRIC

PROIEZIONE EUROPEA
(EUROPEAN PROJECTION)

RAPPRESENTAZIONE GRAFICA DELLE POLARIZZAZIONI (CODING KEY DETAIL)	COLORE (COLOR)	VIE (POSITIONS)	CORAZZA (SHELLS)
	NERO (BLACK)	VIE 21-40 (POS. 21-40) P/N 284150-1	COLORE NERO (COLOR BLACK) P/N 284152-1
	GRIGIO (GRAY)	VIE 1-20 (POS. 1-20) P/N 284150-2	
	NATURALE (NATURAL)	VIE 1-20 (POS. 1-20) P/N 284150-3	
	BLU (BLUE)	VIE 21-40 (POS. 21-40) P/N 284150-4	COLORE BLU (COLOR BLUE) P/N 284152-2

CUSTOMER DRAWING FOR REFERENCE ONLY		DISEGNO PER CLIENTE SOLO PER RIFERIMENTO	
THIS DRAWING IS UNPUBLISHED		RELEASE FOR PUBLICATION 19	
© COPYRIGHT 19 BY AMP INCORPORATED, HARRISBURG, PA. ALL INTERNATIONAL RIGHTS RESERVED. AMP PRODUCTS MAY BE COVERED BY U.S. AND FOREIGN PATENT AND/OR PENDING.			
TOLLERANZE, SE NON DIVERSAMENTE SPECIFICATO	TOLERANCES, UNLESS OTHERWISE SPECIFIED	MATERIALE (MATERIAL)	FINITURA (FINISH)
± 0.3	± 2°	/	/
ANGOLI (ANGLES)			SCALA (SCALE) 2:1
DIS. O. CANUTO (DR.) 22 SEPT. 98		DESCRIZIONE (DESCRIPTION) CONNECTOR 20+20 POS. 2.54 mm PITCH (KIT)	
CONT. A. GENTA (CHK) 22 SEPT. 98		LOC. SIZE NUMERO (CHK NO) I A3 C-284229	
REV. (REV.)	REVISIONI (REVISION RECORD)	DIS. (DR)	E.C.N. (DATE)
		APP. (APP.)	A. BRUNI 22 SEPT. 98

DISTRIBUZIONE (DISTRIBUTION)