

Figure 1

1. INTRODUCTION

This instruction sheet covers the application of all Ceramic and Polymer Ferrule Epoxy Style ST Fiber Optic Connector Kits to fiber optic cable with a jacket diameter no larger than 3.0 mm [.118 in.].

NOTE For Stainless Steel Ferrule ST Connectors, refer to Instruction Sheet 408-4151.

Coupling Receptacle 501381-1 is used to mate two bayonet connectors in free-hanging or panel-mount applications.

NOTE Dimensions in this instruction sheet are in millimeters [with inches in brackets]. Figures and illustrations are for reference only and are not drawn to scale.

•Trademark of Saint-Gobain Performance Plastics Corp.

Read these instructions and all referenced instructions thoroughly before starting assembly.

Reasons for reissue of this instruction sheet are provided in Section 5, REVISION SUMMARY.

This instruction sheet supercedes Instruction Sheet 408-9645.

2. DESCRIPTION (Figure 1)

Each connector kit typically consists of a connector assembly, a protective cover, a crimp eyelet, and strain relief or boot.

Some kits include other components like a clear tubing and a bare buffer boot (both used with 900 µm buffered fiber), small diameter tubing (for use with 250 µm coated fiber), PVC tubing (for use with cables having a jacket diameter less than 2.5 mm [.098 in.], right-angle boots, or bend-limiting strain relief (for use with jacketed cable).

The coupling receptacle kit consists of a coupling receptacle, lock washer, nut, and two protective caps.

3. ASSEMBLY PROCEDURE

3.1. Required Tools and Consumables

The following tools and consumables are recommended for assembling the connector kits (related instruction sheets are in parenthesis).

A. Tools

- Cable Preparation Template 501814-1 or Template Kit 501818-1
- Aramid Shears 1278637-1
- Cable Strip Tool 1754708-1 or Jacket Stripper 501198-1 (408-9394) and No-Nik† Fiber Stripper 504024-1 (size 203 for 125- μ m fiber – red handle)
- Epoxy Mixer 501202-1
- PRO-CRIMPER* III Assembly Tool 1976850-1 and Die Assembly 58424-1 for 3.0 mm [.118 in.] cable diameter (408-4090)
- Protective Sleeve 502259-2
- Heat Cure Oven Assembly 502134-1 (120V) (408-9460)
- Fiber Optic Sapphire Scribe Tool 504064-1 (408-4293)
- Polish Bushing 503337-1 (metal) or 503304-1 (black polymer)
- Polish Plate 501197-1
- Inspection Microscope Kit 1754767-1

B. Consumables

- Alcohol Fiber Wipe Packet 501857-2
- Epoxy Adhesive 1918652-1 or an anaerobic adhesive and anaerobic primer (LOCTITE 648 anaerobic adhesive and LOCTITE 7649 activator is recommended)

NOTE



For characteristics and safety data on epoxy, refer to material safety data sheet (MSDS) supplied by the manufacturer.

- Epoxy Applicator Kit 501473-3
- Resilient Polishing Pad 501523-1
- Polishing Pad 501858-1
- 5- μ m Polishing Film 228433-8
- 1- μ m Polishing Film 228433-7
- .3- μ m Polishing Film 228433-5
- lint-free cloth or tissue
- Final Polishing Film 502748-2

NOTE



Professional Installer's Tool Kits 501258-7, -8, and -9 include all the tools and consumables (except epoxy) required for assembly.

† Trademark of Capewell Components Co.

3.2. Cable Preparation

DANGER



ALWAYS wear safety glasses when working with optical fibers. BE VERY CAREFUL to dispose of fiber ends properly. The fibers create slivers that easily puncture the skin and cause irritation.

A. Jacketed Cable

1. Slide the short strain relief (small diameter end first) onto the cable. If the cable jacket diameter is less than 2.5 mm [.1 in.], slide the PVC tubing onto the cable. Slide the crimp eyelet (rolled end first) onto the cable.
2. Refer to the "OPTIMATE 2.5mm Bayonet (Polymer Composite)" strip length template (from the cable preparation template kit) or refer to Figure 2, Detail A, and using the cable stripper, strip the jacket to the dimension shown. Using the shears, trim the strength members to dimension shown. Using the fiber stripper, strip the buffer, then the coating to the dimension shown.

NOTE



For specific techniques on stripping (using the fiber stripper), see Instruction Sheet 408-9485.

3. Clean the fiber thoroughly using an alcohol fiber wipe.
4. Evenly "fan out" the strength members from the buffer.

B. 900 μ m Buffered or 250 μ m Coated Fiber

1. For buffered fiber, slide the bare buffer boot (small diameter end first), crimp eyelet (rolled end first), and clear tubing onto the buffered fiber.

For coated fiber, slide the bare buffer boot (small diameter end first), crimp eyelet (rolled end first), clear tubing, and small diameter tubing onto the coated fiber.

2. Strip the buffer and/or coating so that 16-17 mm [.630-.670 in.] of bare-glass is exposed, refer to the strip template, or Figure 2, Detail B.

NOTE



For specific techniques on stripping (using the fiber stripper), see instruction sheet 408-9485.

3. Clean the fiber thoroughly using an alcohol fiber wipe.

Recommended Stripping Dimensions

Detail A — Jacketed Cable

Polymer Ferrule Connectors

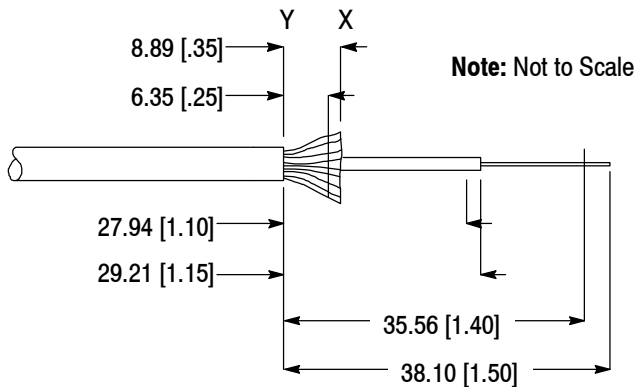

Ceramic Ferrule Connectors

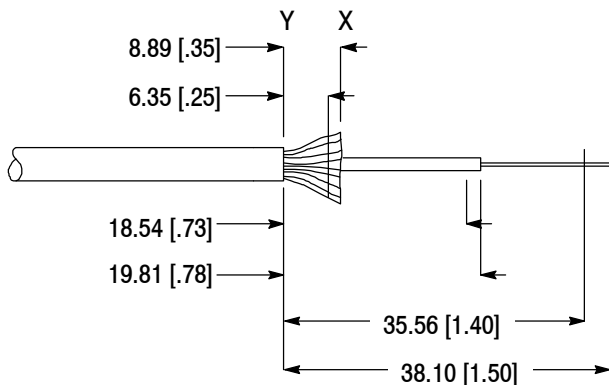

Detail B — Buffered Fiber, or Coated Fiber

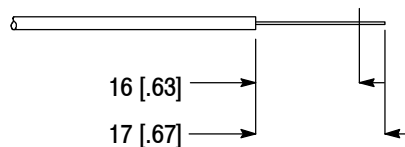

Figure 2

3.3. Preparing the Epoxy

1. Remove the separating clip from the epoxy package, and mix the epoxy thoroughly for 20 to 30 seconds. It is recommended to use the epoxy mixer for thorough mixing of the components.
2. Install the needle tip on the epoxy applicator. Make sure it is secure. Remove the plunger.
3. Cut the epoxy packet open, and squeeze the epoxy into the back of the applicator. Re-assemble the plunger. Hold the applicator vertically, and slowly push on the plunger until the entrapped air escapes and a bead of epoxy appears at the tip.

NOTE



An alternate method in preparing the epoxy is as follows:

1. Remove the tip of the epoxy applicator by twisting it one-quarter turn and pulling it away from the body of the applicator.
2. Install the open end of the epoxy applicator into the epoxy, and pull back on the plunger to draw epoxy into the applicator. See Figure 3.
3. Slide the tip onto the applicator, making sure it is firmly secured. Hold the applicator vertically, and slowly push on the plunger until a bead of epoxy appears at the tip.

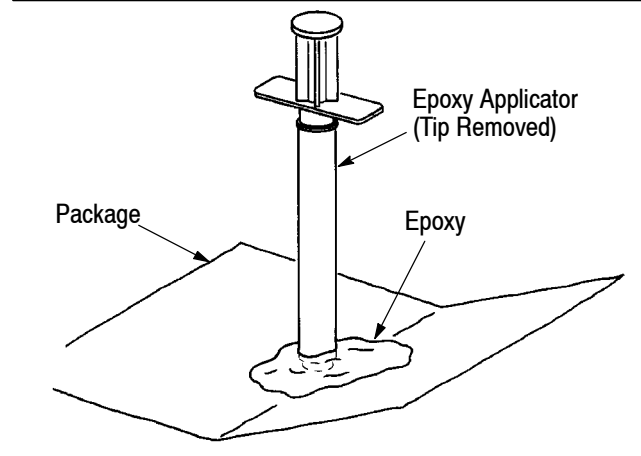

Figure 3

3.4. Terminating the Fiber

1. Remove the protective cap from the connector. Hold the connector with the knurled end up. Insert the tip of the epoxy applicator as far as possible into the connector body. See Figure 4, Detail A.
 2. Inject the epoxy into the connector until a small bead with a diameter of approximately 0.76 mm [.030 in.], appears at the tip of the ferrule. **DO NOT** allow the bead get too large or smear.
 3. Withdraw the applicator while simultaneously injecting the epoxy into the bore of the connector until it is approximately three-quarters full.
 4. For jacketed cable, apply a drop of epoxy to the outside of the knurled end of the connector, and distribute it evenly around the circumference of the knurled end. See Figure 4, Detail B. **DO NOT** allow any epoxy on the coupling nut or spring area.
 5. Using a twisting motion, gently insert the fiber into the connector until it bottoms. The fiber should appear at the tip of the ferrule. Refer to Figure 4, Detail C.
- For jacketed cable, make sure that the strength members are spread out evenly over the knurled end of the connector. See Figure 4, Detail C.

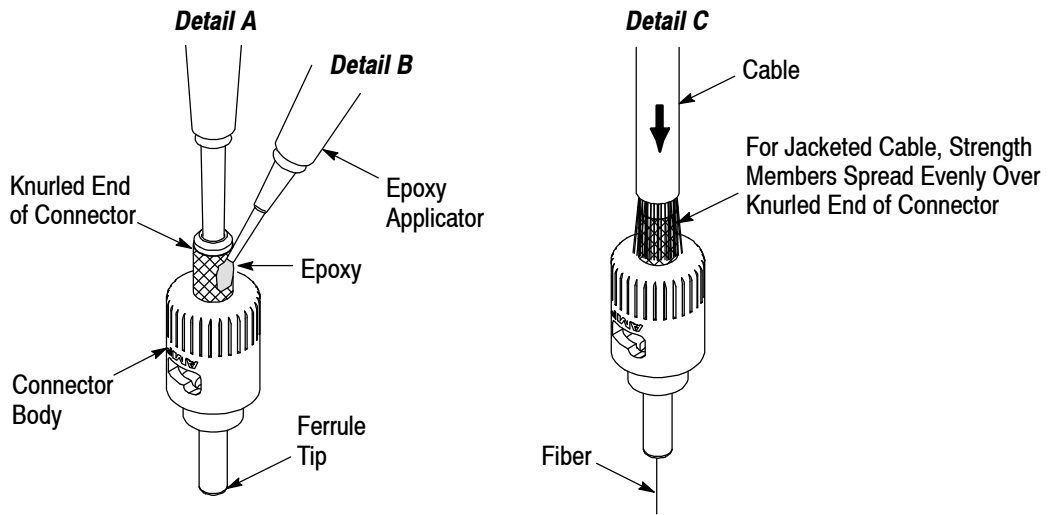

Figure 4

6. Twist the connector, and move it back and forth axially approximately 1.5 mm [.060 in.] to distribute the epoxy in the bore of the connector.

For buffered fiber, slide the clear tubing against the back of the connector, then slide the crimp eyelet over the clear tubing and onto the connector. See Figure 5.

For coated fiber, slide the small diameter tubing and clear tubing against the back of the connector, then slide the crimp eyelet over the clear tubing and onto the connector. See Figure 5.

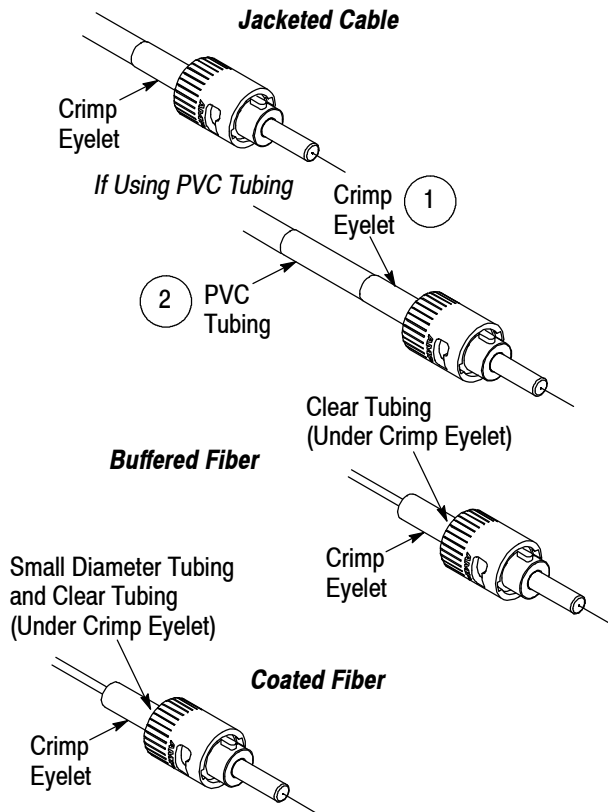

Figure 5

7. For jacketed cable, slide the crimp eyelet toward the connector until it contacts the connector shoulder, trapping the strength members against the knurled end. If using the PVC tubing, slide it under the crimp eyelet until it bottoms. See Figure 5.

Terminating the Connector

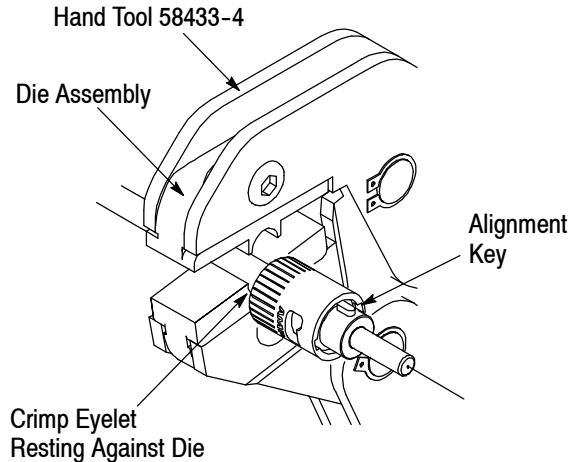

Figure 6

3.5. Crimping the Connector



CAUTION Make sure to crimp the connector before the epoxy cures.

1. Position the connector in the die assembly as shown in Figure 6.

NOTE

On all multi-fiber cable where the fibers lie in a plane, position the connector alignment keys in the same orientation during crimping.

2. Actuate the tool according to the instructions packaged with the tool.
3. Slide the protective sleeve onto the connector, and snap it into place using the coupling nut.
4. Clean excess epoxy from the connector, tool, and die assembly.
5. Taking care not to break the protruding fiber, firmly hold the front of the connector, and slide the short strain relief or bare buffer boot over the crimp eyelet and onto connector shoulder until it bottoms.

3.6. Curing the Epoxy

1. Hang the connector vertically with the tip down.
2. Using the heat cure oven assembly, cure the assembly 1 hour at 65°C [149°F].

3.7. Cleaving the Fiber

DANGER

ALWAYS wear safety glasses when working with optical fibers. BE VERY CAREFUL to dispose of fiber ends properly. The fibers create slivers that easily puncture the skin and cause irritation.

1. Carefully remove the protective sleeve from the connector.
2. Firmly support the connector assembly.
3. Place the blade of the scribe tool directly above the epoxy, and lightly draw the beveled edge across the fiber parallel to the tip of the ferrule. See Figure 7. After scoring the fiber, pull it straight away from the connector.

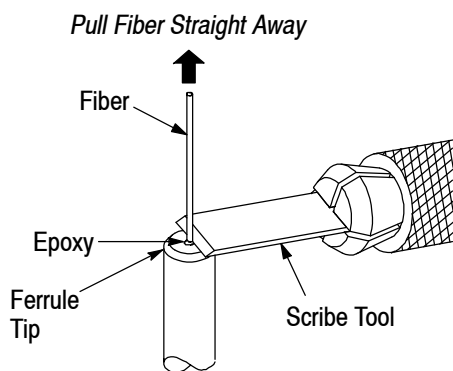

Figure 7

DANGER

BE VERY CAREFUL to dispose of fiber ends properly. The fibers create slivers that can easily puncture the skin and cause irritation.

4. Insert the connector into the polishing bushing. See Figure 8.

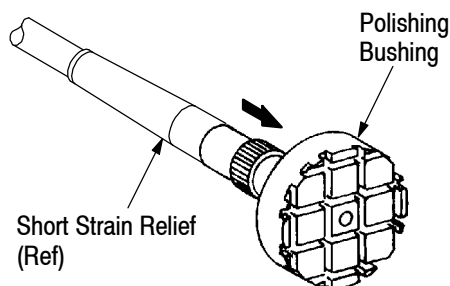

Figure 8

3.8. Polishing the Fiber

1. Choose a flat end finish or physical contact (PC) end finish.

NOTE

The flat end finish is recommended when the connector might be exposed to a tough mechanical environment, and the PC end finish is recommended for singlemode connectors and will provide better performance by reducing the optical power reflected back to the source.

2. For the flat end finish, place the white polishing pad on the polishing plate. For the PC end finish, place the green polishing pad on the polishing plate.
3. Place the 5- μ m polishing film on top of the polishing pad.

CAUTION

ALWAYS place the polishing bushing on a clean area of the polishing film. NEVER start polishing on or across a dirty section of the film.

4. Holding the polishing bushing, not the connector, start polishing very lightly. Polish in an elongated figure 8 pattern. See Figure 9. Initially a small amount of exposed fiber will be worn away. This is indicated by a narrow white trace on the film. As the exposed fiber wears away, the trace will widen and darken, indicating that epoxy is being removed. At this point a moderate downward force may be applied while polishing. Check the tip of the ferrule often, and stop polishing on the 5- μ m film when the epoxy is light blue.

5. Clean the polishing bushing and connector assembly with an alcohol fiber wipe.

Figure 8 Pattern

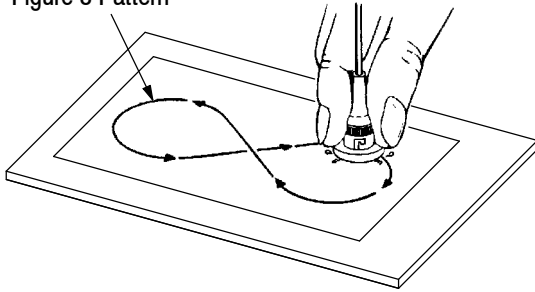

Figure 9

6. For the flat end finish, use the 1- μ m film on the white polishing pad, and polish the fiber until only a very light blue trace of epoxy remains.

For the PC end finish, use the 1- μ m film on the green polishing pad, and polish the fiber for about 20 seconds.

7. Clean the polish bushing and connector assembly with an alcohol fiber wipe.

8. For both type end finishes, using the .3- μ m film on the appropriate polishing pad, polish the fiber until all the epoxy is gone. Use only a light force on the polishing bushing. DO NOT over polish. Using the microscope, examine the tip of the ferrule. Stop polishing as soon as all the epoxy has been removed.

9. For the flat end finish, clean the connector with an alcohol fiber wipe, and dry with a lint-free cloth or tissue.

For the PC end finish, remove the connector from the polishing bushing and place the final polishing film on the polishing pad. Apply a few drops of water to an unused area of the film. Move the connector on the water in 20 mm [.75 in.] diameter circles for 25 seconds to polish the fiber.

NOTE

One piece of final polishing film will be sufficient for 10 to 20 connectors.



10. Clean the connector with an alcohol fiber wipe, and wipe dry with a lint-free cloth or tissue.

3.9. Inspecting the Endface

DANGER



NEVER inspect or look into the end of a fiber when optical power is applied to the fiber. The infrared light used, although it cannot be seen, can cause injury to the eyes.

1. Inspect the polished fiber and ferrule (endface) with the microscope. Refer to Figure 10, and check for the following:

- Dark scratches on the endface.

This indicates that dirt was present during the polishing process. For PC end finish, some scratches can be removed by further polishing with polishing compound. Apply a fresh drop of compound to an unused area of the polishing cloth, and polish for 10 seconds. Re-examine the endface. DO NOT polish again if scratches remain. For flat end finish, polish for 15 seconds on the .3- μ m film. Re-examine the endface.

- Small pits in the endface. This indicates that the fiber was polished too long on either the 5- or 1- μ m film. Some pitting might not interfere with connector performance if it is not in the core area.
- A lot of pits in the endface. This indicates that the fiber was polished too long on the 5- μ m film.
- A large fracture at the edge of the fiber (small chips in the outer rim of the fiber are permissible). This indicates that the fiber was broken below the surface of the ferrule during cleaving or initial polishing.

2. Place the protective cap on the ferrule of the connector if the connector is not going to be mated immediately.

Acceptable

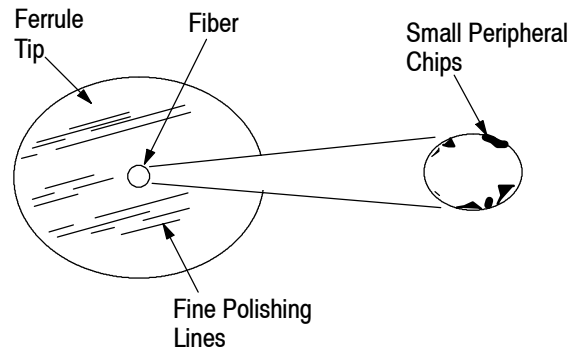

Unacceptable

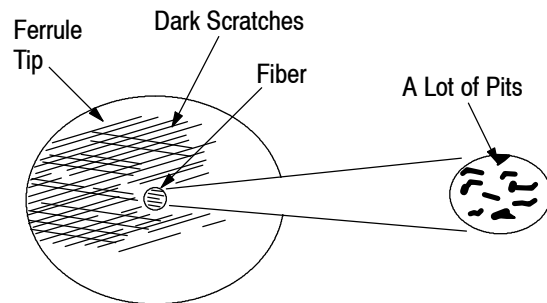

Figure 10

Recommended Panel Cutout

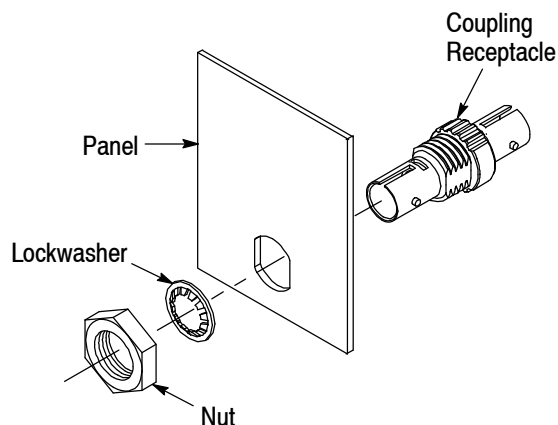
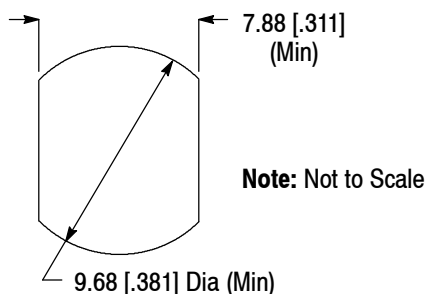

Figure 11

3.10. Using the Coupling Receptacle Kit

The coupling receptacle can be used free hanging, or it can be mounted on a panel. To mount the receptacle on a panel, proceed as follows:

1. Cut out the panel according to the dimensions given in Figure 11.
2. Assemble the coupling receptacle, lockwasher, and nut as shown in Figure 11.
3. Lock the connectors into place using the coupling nut.

NOTE



After coupling, ALWAYS push in axially on the back of each connector to ensure intimate contact.

4. Place the protective caps on the coupling receptacle if the connectors are not going to be mated immediately.

4. REPLACEMENT AND REPAIR

Kit components are not repairable. Replace any damaged or defective components. DO NOT re-use terminated connectors by removing the cable.

5. REVISION SUMMARY

Revisions to this instruction sheet include:

- Updated document to corporate requirements.