

640457-2 Product Details

[Share](#) [Print](#) [Email](#)

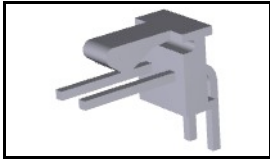

640457-2

TE Internal Number: 640457-2

 Active

 [View 3D PDF](#)

MTA, CST-100 II, MT-6 and SL Connectors and Headers

 Always EU RoHS/ELV Compliant
(Statement of Compliance)

Product Highlights:

- MTA-100 Product Line
- MTA Series
- Wire-to-Board
- Applies To Printed Circuit Board
- Connector

[View all Features](#)

Quick Links

- ▶ [Pricing & Availability](#)
- ▶ [Search for Tooling](#)
- ▶ [View Mating Products \(76\)](#)
- ▶ [Product Feature Selector](#)
- ▶ [Contact Us About This Product](#)

[Add to My Part List](#)

[Request Sample](#)

[Find Similar Products](#)

[Buy Product](#)

Documentation & Additional Information

Product Drawings:

- [MTA 100 HEADER ASSEMBLY, FRICTION LOCK, NOTCHED, .02...](#) (PDF, English)

Catalog Pages/Data Sheets:

- [MTA, CST-100 II, SL-156 and AMP Economy Power \(EP\) C...](#) (PDF, English)

Product Specifications:

- None Available

Application Specifications:

- None Available

Instruction Sheets:

- None Available

CAD Files: (CAD Format & Compression Information)

- [2D Drawing](#) (DXF, Version S)
- [3D Model](#) (IGES, Version S)
- [3D Model](#) (STEP, Version S)

[List all Documents](#)

Additional Information:

- [Product Line Information](#)

Related Products:

- [Tooling](#)
- [Mating Products \(76\)](#)

Product Features (Please use the Product Drawing for all design activity)

Product Type Features:

- [Product Line](#) = MTA-100
- Series = MTA
- Product Type = Connector
- Connector Type = Header
- Termination Method to Wire/Cable = Solder
- Post Size (mm [in]) = 0.64 [.025]
- Termination Method to PC Board = Through Hole - Solder
- [PCB Mounting Orientation](#) = Right Angle
- PCB Mount Retention = Without
- PCB Mount Alignment = Without
- [Right Angle Bending Side](#) = Front
- Strain Relief = Without
- Sealed = No
- UL File Number = E28476

Housing Features:

- Connector Style = Plug
- Centerline (mm [in]) = 2.54 [0.100]
- Housing Style = Friction Lock
- Housing Material = Polyester
- Housing Color = Natural
- [Mating Alignment](#) = Without
- UL Flammability Rating = UL 94V-0

Configuration Features:

- [Number of Positions](#) = 2
- [Post Number\(s\) Omitted](#) = None
- [Backwall/Post Interruption\(s\)](#) = Without
- Number of Rows = 1

Industry Standards:

- CSA File Number = LR7189

Mechanical Attachment:

- Contact Retention = Without
- Mating Retention Type = Friction Lock
- [Panel Mount Retention](#) = Without

Electrical Characteristics:

- Contact - Rated Current (A) = 5
- Operating Voltage Reference = AC
- Operating Voltage (VAC) = 250

Termination Features:

- Tail Length (mm [in]) = 3.56 [0.14]

Dimensions:

- Mating Post Length (mm [in]) = 7.49 [0.295]
- PCB Thickness, Recommended (mm [in]) = 1.60 [0.063]

Body Features:

- Header Type = Unshrouded
- Mating Retention = With
- Underplate Material Thickness (μm [μin]) = 1.27 [50.000]
- Assembly Integration Feature = Without

Contact Features:

- Contact Type = Pin
- [Contact Shape](#) = Square
- [Contact Base Material](#) = Copper Alloy
- [Contact Plating, Mating Area, Material](#) = Tin
- Tail Plating Material = Tin
- Contact Style = Right-Angle
- Contact Layout = In-Line
- Multiple Contact Types = Without
- Contact Plating, Mating Area, Thickness (μm [μin]) = 3.81 [150]
- Tail Plating Thickness (μm [μin]) = 3.81 [150]
- Underplate Material = Nickel

- [RoHS/ELV Compliance](#) = RoHS compliant, ELV compliant
- [Lead Free Solder Processes](#) = Wave solder capable to 240°C, Wave solder capable to 260°C, Wave solder capable to 265°C
- RoHS/ELV Compliance History = Always was RoHS compliant
- Agency/Standard = UL, CSA
- UL Rating = Recognized
- CSA Rating = Certified

Environmental:

- Operating Temperature ($^{\circ}\text{C}$ [$^{\circ}\text{F}$]) = -55 - +105 [-67 - +221]

Conditions for Usage:

- [Applies To](#) = Printed Circuit Board
- For Use With = MTA .100 Connector Assembly

Operation/Application:

- Application Use = Wire-to-Board

Packaging Features:

- Packaging Method = Package
- Packaging Quantity = 1

Other:

- Brand = AMP

Corporate Information

- [About TE](#)
- [Investors](#)
- [News Room](#)
- [Supplier Portal](#)
- [Careers](#)
- [Terms & Conditions](#)
- [Privacy Policy](#)

Quick Links

- [Distributor Inventory](#)
- [Product Cross Reference](#)
- [Documents & Drawings](#)
- [Product Compliance Support Center](#)
- [Site Map](#)

Customer Support

- [Email or Chat With Us](#)
- [Find a Phone Number](#)
- [Knowledge Base](#)
- [Manage Your Account](#)

Keep Me Informed



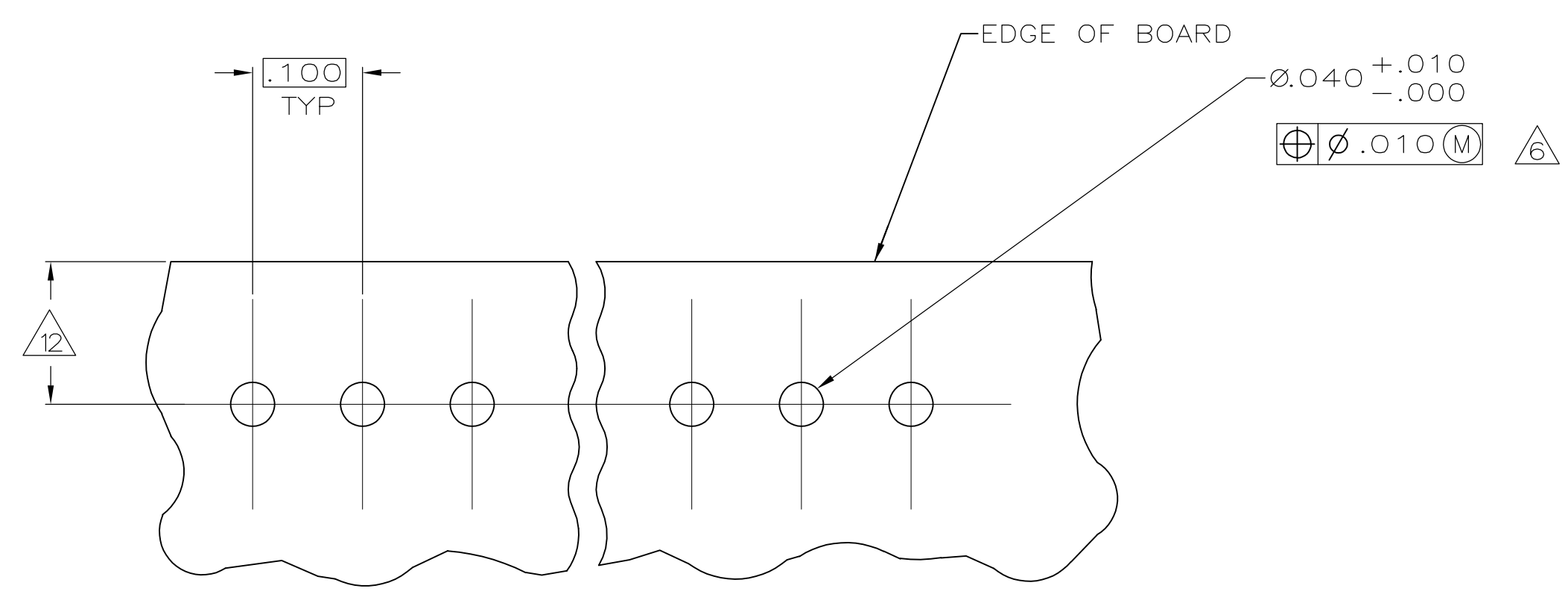
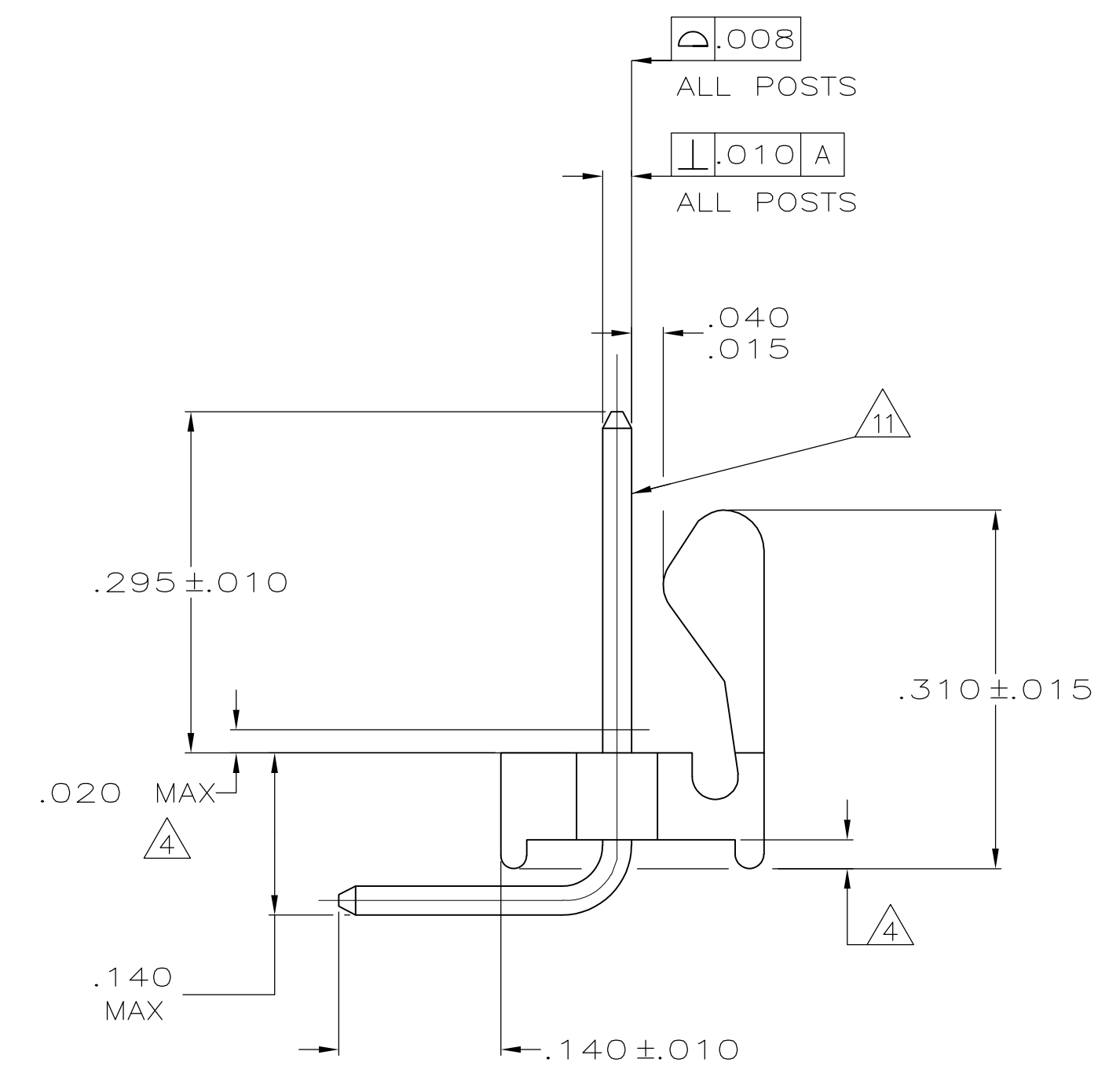
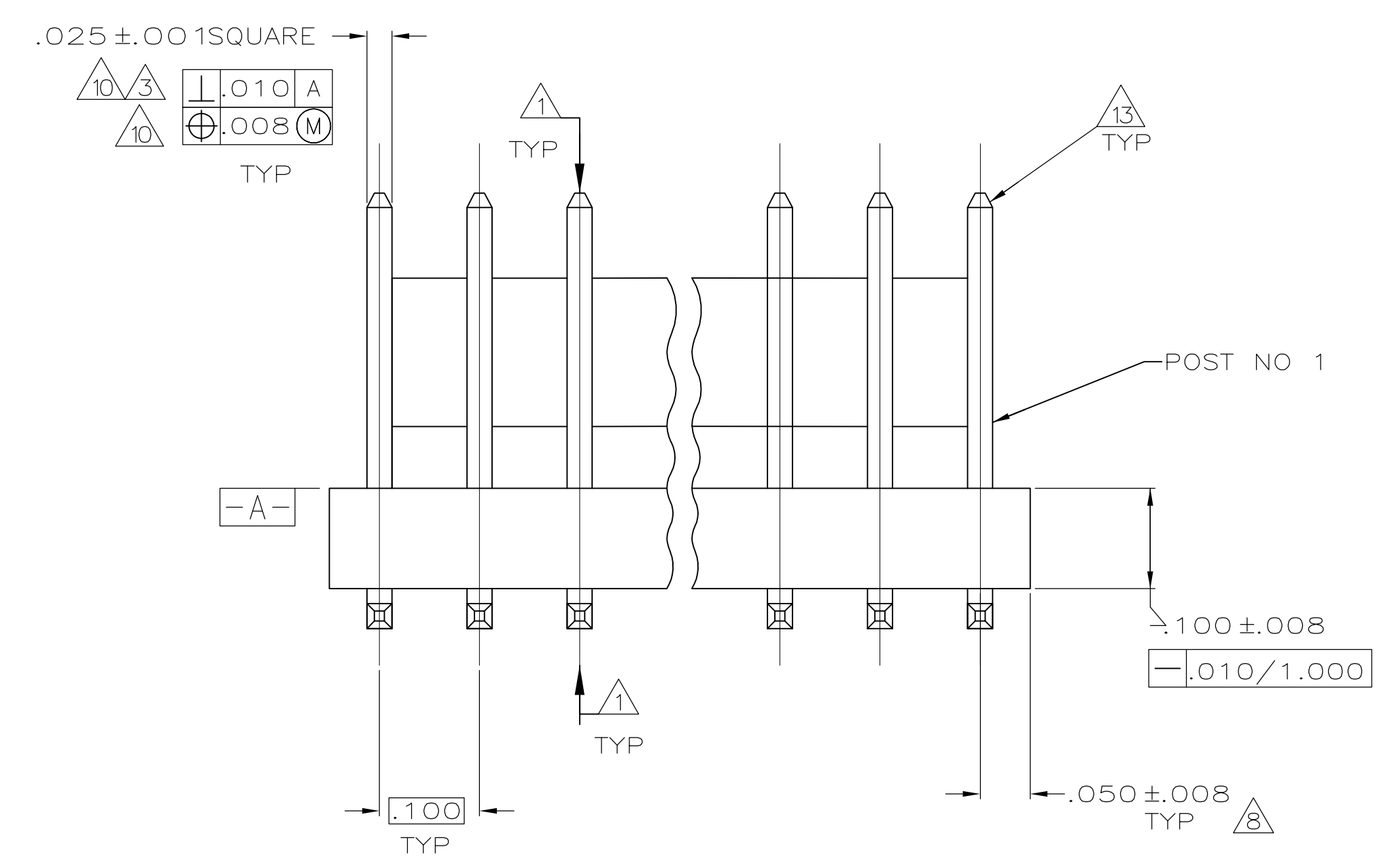
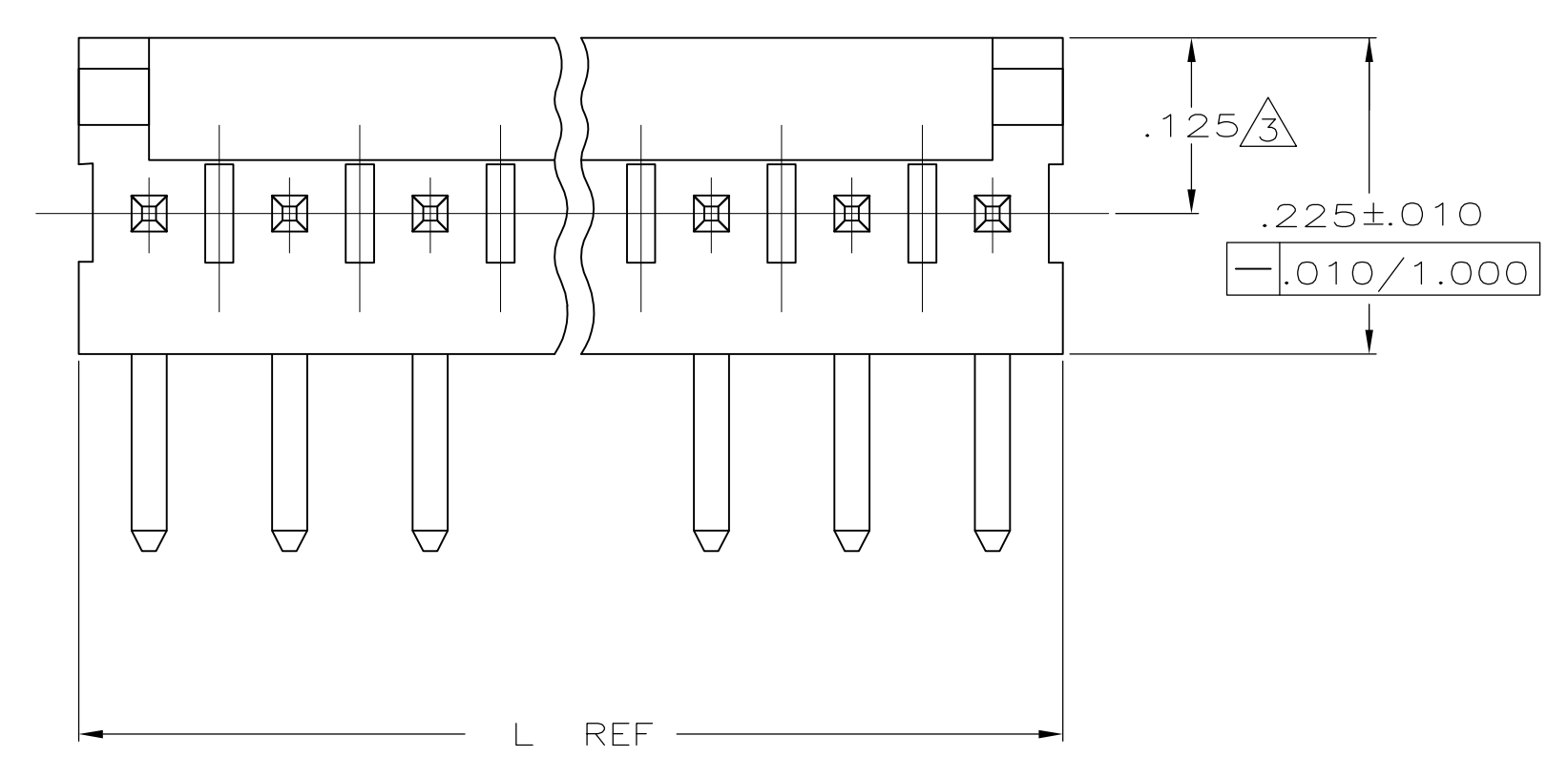

- 1. POST TO WITHSTAND 13 NEWTONS (3LBS.) MIN. AXIAL FORCE IN BOTH DIRECTIONS SHOWN WITHOUT DISLODGING.
- 2. TOLERANCES APPLY TO SOLDER SIDE OF BOARD.
- 3. MEASURED AT SURFACE [-A-]
- 4. PLASTIC FLASH PERMITTED IN THIS AREA.
- 5. PARTS COMPLY WITH AMP SOLDERABILITY SPEC. NO. 109-11-2.
- 6. ONE HOLE MAY BE UNDERSIZED (.035/.032 DIA.) FOR ASSEMBLY RETENTION DURING WAVE SOLDERING.
- 7. MATERIAL: HEADER-THERMOPLASTIC POLYESTER 94V-0(NATURAL) POST-COPPER ALLOY (TIN PLATED)
- 8. COORDINATE DIMENSION APPLIES FROM CENTER OF ACTUAL FEATURE.
- 9. PLASTIC BURRS CAUSED BY CUT-OFF TOOLING ARE PERMITTED WITHIN THE MAXIMUM TOLERANCE ENVELOPE.
- 10. POST TO BE MEASURED WHEN STRIP IS HELD FLAT.
- 11. POST MUST WITHSTAND TWO 90° BENDS AGAINST EXTRUSION WITHOUT BREAKING.
- 12. DIMENSION SHOULD BE .110-.160 WHEN MATING WITH A MTA 100 CONNECTOR ASSEMBLY OR .110-.120 WHEN MATING WITH A CST 100 CONNECTOR.
- 13. PIN BURR OF .005 MAX. VERTICAL AND .003 MAX. HORIZONTAL PERMITTED AT POST TIPS ON BOTH ENDS.

		1.000	25.40
.040	1.02	.310	7.87
.035	0.89	.295	7.49
.032	0.81	.225	5.72
.025	0.64	.160	4.06
.020	0.51	.140	3.56
.015	0.38	.125	3.18
.010	0.25	.120	3.05
.008	0.20	.110	2.79
.005	0.13	.100	2.54
.003	0.08	.063	1.60
.001	0.03	.050	1.27
IN	MM	IN	MM

RECOMMENDED MOUNTING HOLE PATTERN FOR .063 THICK P.C. BOARD

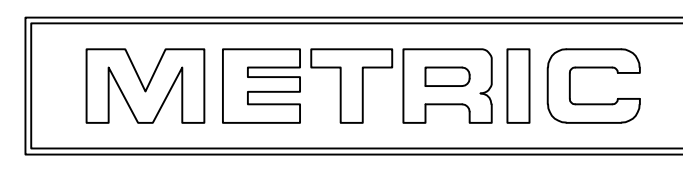

2.800	71.12	28	2-640457-8
2.700	68.58	27	2-640457-7
2.600	66.04	26	2-640457-6
2.500	63.50	25	2-640457-5
2.400	60.96	24	2-640457-4
2.300	58.42	23	2-640457-3
2.200	55.88	22	2-640457-2
2.100	53.34	21	2-640457-1
2.000	50.80	20	2-640457-0
1.900	48.26	19	1-640457-9
1.800	45.72	18	1-640457-8
1.700	43.18	17	1-640457-7
1.600	40.64	16	1-640457-6
1.500	38.10	15	1-640457-5
1.400	35.56	14	1-640457-4
1.300	33.02	13	1-640457-3
1.200	30.48	12	1-640457-2
1.100	27.94	11	1-640457-1
1.000	25.40	10	1-640457-0
.900	22.86	9	640457-9
.800	20.32	8	640457-8
.700	17.78	7	640457-7
.600	15.24	6	640457-6
.500	12.70	5	640457-5
.400	10.16	4	640457-4
.300	7.62	3	640457-3
.200	5.08	2	640457-2
IN	MM	NO OF POSITIONS	PART NUMBER

THIS DRAWING IS A CONTROLLED DOCUMENT.

DIMENSIONS: mm [INCHES]	TOLERANCES UNLESS OTHERWISE SPECIFIED:	0 PLC ± -	1 PLC ± -	2 PLC ± -	3 PLC ± .005	4 PLC ± -	ANGLES ± -
FINISH		APVD: R. SPEER 3-11-93					
MATERIAL		NAME: MTA 100 HEADER ASSEMBLY, FRICTION LOCK, NOTCHED, .025 SQUARE RIGHT ANGLE POST, TIN PLATED					
CUSTOMER DRAWING		SCALE: 8:1		SHEET 1 OF 1		REV S1	

STE TE Connectivity

SIZE: A1 CAGE CODE: 00779 DRAWING NO: 640457