

MULTI-BEAM XL Power Distribution Connector System

Board Mount Connectors

Product Facts

- Single-piece molded housings
- Custom configurable modular design
- AC and DC power in the same connector — Meets UL safety requirements
- Current Interrupt ratings per UL 1977 — for “Hot-Plug” applications
- Compact size — ideal for distributed DC power applications
- Molded-in guide pins provide generous blind-mateability
- Up to 3 levels of contact sequencing:
 - 1st — Pwr/Gnd
 - 2nd — Pwr & Signals
 - 3rd — Trigger Signals
- Low Mating and Un-mating force
- Solder or press-fit termination to PCB
- Meets SSI power connector requirements for DPS, MPS and HPS applications
- 30 micro-inch [0.76 micro-meters] gold post-plated contacts for high reliability
- All MULTI-BEAM XL products in this section are RoHS compliant

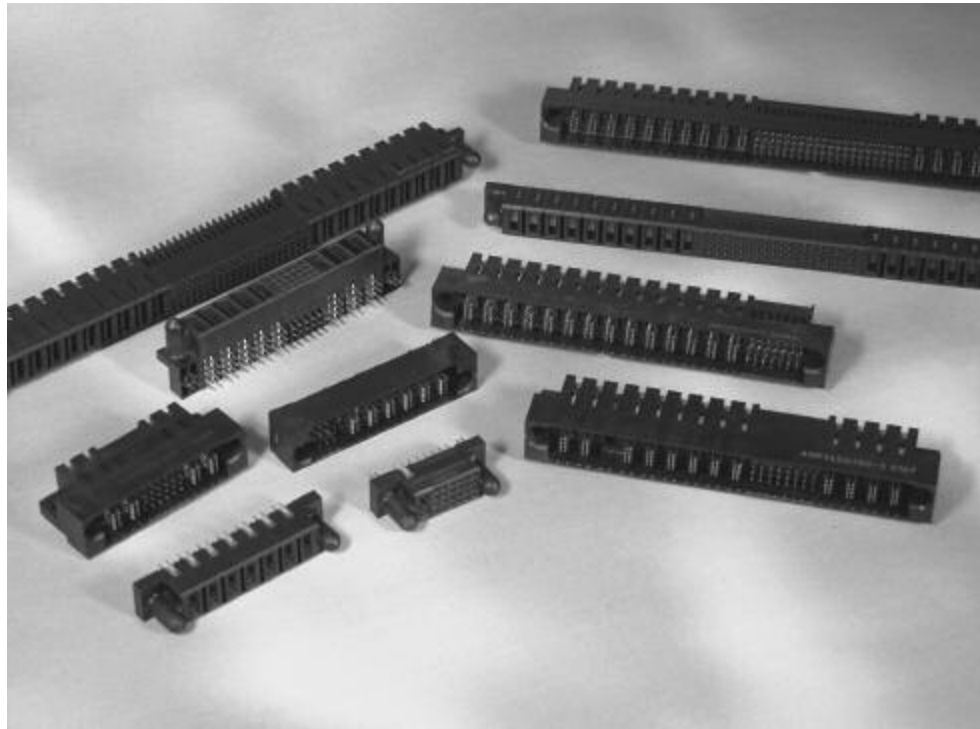

MULTI-BEAM XL is a blind-mateable board-to-board power distribution connector system. The heart of the MULTI-BEAM XL connector is the unique power contact which offers higher current ratings, lower contact resistance and lower mating forces than alternative designs. The connector is designed and manufactured in a modular approach and therefore allows the customer to select the number of power and signal contacts as well as the mating sequence of contacts they need for their specific application.

The product is also available in versions complying to the Server Systems Infrastructure (SSI) Standard. The MULTI-BEAM XL product offers high reliability and high current density in a package designed specifically for modular hot-swappable power distribution systems.

MULTI-BEAM XL connectors are ideal for blind-mating in modular and rack mounted systems. The high performance design and heavy gold plated contacts meet requirements across many applications including Power Distribution for

compact (1U) computer servers up through High-End Servers, Fault-tolerant Computers, Networking Equipment, Telecommunication Switches, Medical Instrumentation and Industrial Control equipment.

The compact design also meets the I/O needs of modern Modular and Hot-Swappable redundant (N+1) Power Supplies and Uninterruptible Power Supplies.

Technical Documents

Product Specifications — 108-1973

Application Specification — 114-13038

 File # E28476

 File # LR7189

For More Information

Internet
<http://tycoelectronics.com>

Check out product information at:
<http://mbxl.tycoelectronics.com>

Technical Support Center
1-800-522-6752

MULTI-BEAM XL Power Distribution Connector System (Continued)

Board-to-Board Products

Board Mount Connectors

Power Contacts

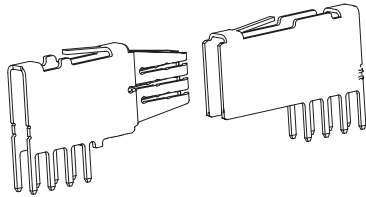

Signal Contacts

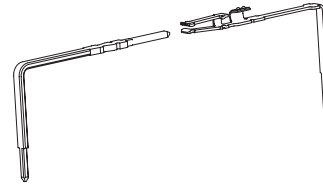

- Improved MULTI-BEAM XL power contact design features eight independent beams which provide:
 - Electrical performance — Parallel current paths yield a lower contact resistance
 - Mechanical performance — Tuned beam design provides low mating forces and high durability life cycles
 - Traditional Dual-Beam design also available
- Twin-beam signal receptacle contact design mates on milled surface, to reduce plating wear / and improve durability
- MULTI-BEAM XL connector assures you of **EXTRA LONG CONTACT WIPE**
 - Power contacts feature up to 0.200" [5.08mm] minimum wipe
 - Shortest "trigger" signal contacts feature a minimum wipe of 0.100" [2.54mm]
- MULTI-BEAM XL connectors provides **EXPANDABLE LENGTH** connectors
 - Overall length is expandable to accommodate up to 36 power contacts
 - Contact spacings are expandable to accommodate higher voltages and/or higher current requirements
- Base metal made from high conductivity copper alloy (over 98% copper) offers superior performance compared to alternative materials (brass, phosphor bronze, beryllium copper, etc.) often used in power connectors
- 0.100" [2.54mm] x 0.100" [2.54mm] PCB contact grid

Application Flexibility

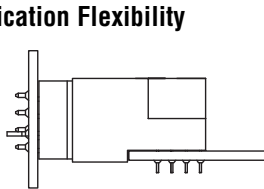

Vertical Receptacle Right Angle Plug

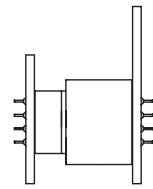

Vertical Receptacle Vertical Plug

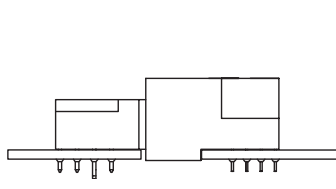

Right Angle Receptacle Right Angle Plug

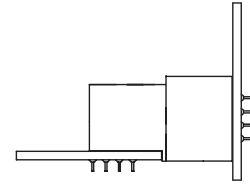

Right Angle Receptacle Vertical Plug

Contact Wipe

Contact Type	Description	Sequence	Minimum Wipe
Power (or GND) Contact	Make First Break Last (MFBL)	1	0.200" [5.08mm]
Power Contact	Standard	2	0.150" [3.81mm]
Signal Contact	Standard	2	0.150" [3.81mm]
Signal (trigger) Contact	Make Last Break First (MLBF)	3	0.100" [2.54mm]

The MLBF power contact and the Standard Signal contact are sequenced to mate at the same time ... sequence #2.

Product Configurations and Part Numbers

The connector configuration is described by reading Left-to-Right on the Plug mating interface and Right-to-Left on the Receptacle mating interface. Custom configurations can be produced due to the modular design of the product. Some popular configurations are shown in the tables below.

Configuration Description: ACP indicates AC Power, P indicates DC Power, HDP indicates High Density Power, S indicates Signal. The corresponding contact spacing and voltage ratings are shown below.

ACP	P	HDP	S
0.300" [7.62mm] spacing	0.250" [6.35mm] spacing	0.200" [5.08mm] spacing	0.100" [2.54mm] grid
300 Volts*	200 Volts*	Connection to same voltage*	60 Volts*

* With circuit board designed to UL 1950, IEC 60950

MULTI-BEAM XL Power Distribution Connector System (Continued)

Board Mount Connectors
Right Angle Receptacles

Configuration *	Part Number	Application	Overall Length " and [mm]	PCB Tail Type (Solder, Press-Fit)	Power Contact Sequencing
1P/24S/1P	6450160-3	SSI "DPS"	1.925" [48.90mm]	Solder	No
2P/24S/2P	1-6450160-0	Distributed DC Power + Signal	2.250" [57.15mm]	Solder	No
3P/24S/3P	6450570-2	Distributed DC Power + Signal	2.750" [69.85mm]	Press-fit	Yes
3ACP/24S/5P	6450170-2	AC and DC Power + Signal	3.400" [86.36mm]	Solder	Yes
3ACP/24S/6P	6450170-8	AC and DC Power + Signal	3.650" [92.71mm]	Solder	Yes
5P/24S/6P	6450160-5	SSI "MPS"	4.350" [110.49mm]	Solder	No
5P/32S/5P	6450560-2	Distributed DC Power + Signal	3.950" [100.33mm]	Press-fit	No
7P/32S/7P	6450560-4	Distributed DC Power + Signal	4.350" [110.49mm]	Press-fit	No
8P/28S	6450172-2	Distributed DC Power + Signal	3.350" [85.09mm]	Solder	Yes
8P/32S/8P	6450160-1	AC and DC Power + Signal	5.450" [138.43mm]	Solder	No
10P/84S/10P	6450160-6	AC and DC Power + Signal	7.750" [196.85mm]	Solder	No
3ACP	6450173-1	AC Power	1.550" [39.37mm]	Solder	Yes
8P	6450163-2	DC Power	2.650" [67.31mm]	Solder	No
14P/32S	6450172-1	Distributed DC Power + Signal	4.950" [125.73mm]	Solder	Yes
16S/4P	6450161-1	Distributed DC Power + Signal	2.050" [52.07mm]	Solder	No
24S/6P	6450161-2	Distributed DC Power + Signal	2.750" [69.85mm]	Solder	No
24S/8P	6450161-6	Distributed DC Power + Signal	3.250" [82.55mm]	Solder	No

* Custom configurations are available — see page 28 for instructions to have Tyco Electronics build your custom part.

Vertical Receptacles

Configuration *	Part Number	Application	Overall Length " and [mm]	PCB Tail Type (Solder, Press-Fit)	Power Contact Sequencing
1P/24S/1P	6450540-1	SSI "DPS"	1.925" [48.90mm]	Press-fit	No
2P/24S/2P	6450140-1	Distributed DC Power + Signal	2.250" [57.15mm]	Solder	No
3P/24S/3P	1-6450140-0	Distributed DC Power + Signal	2.750" [69.85mm]	Solder	No
4P/24S/4P	6450150-6	Distributed DC Power + Signal	3.350" [85.09mm]	Solder	Yes
4P/24S/3ACP	6450150-3	AC and DC Power + Signal	3.150" [80.01mm]	Solder	Yes
3ACP/24S/5P	6450550-1	AC and DC Power + Signal	3.400" [86.36mm]	Press-fit	Yes
5P/24S/6P	6450540-2	SSI "DPS"	4.350" [110.49mm]	Press-fit	No
6P/24S/6P	4-6450550-5	Distributed DC Power + Signal	4.250" [107.95mm]	Press-fit	No
10P/84S/10P	6450140-4	Distributed DC Power + Signal	7.750" [196.85mm]	Solder	No
10P/24S/12P	3-6450550-2	Distributed DC Power + Signal	5.800" [147.32mm]	Press-fit	Yes
3P	6450543-1	DC Power	1.400" [35.56mm]	Press-fit	No
3ACP	6450543-6	AC Power	1.550" [39.37mm]	Press-fit	No
4P	6450543-5	DC Power	1.650" [41.91mm]	Press-fit	No
5P	6450553-1	DC Power	1.900" [48.26mm]	Press-fit	Yes
6P	6450553-2	DC Power	2.050" [52.07mm]	Press-fit	Yes
7P	6450543-3	DC Power	2.400" [60.96mm]	Press-fit	No
8P/28S	6450142-3	Distributed DC Power + Signal	3.350" [85.09mm]	Solder	No
14P/32S	6450152-1	Distributed DC Power + Signal	4.950" [125.73mm]	Solder	Yes
24S/6P	6450551-1	Distributed DC Power + Signal	2.750" [69.85mm]	Press-fit	Yes
24S/3ACP	6450151-3	Distributed DC Power + Signal	2.200" [55.88mm]	Solder	Yes
24S/8P	6450541-5	Distributed DC Power + Signal	3.250" [82.55mm]	Press-fit	No

* Custom configurations are available — see page 28 for instructions to have Tyco Electronics build your custom part.

Note: All part numbers are RoHS compliant.

MULTI-BEAM XL Power Distribution Connector System (Continued)

Board Mount Connectors
Right Angle Plugs

Configuration *	Part Number	Application	Overall Length " and [mm]	PCB Tail Type (Solder, Press-Fit)	Signal Contact Sequencing
1P/24S/1P	6450330-1	SSI "DPS"	1.925" [48.90mm]	Solder	Yes
2P/24S/2P	6450120-2	Distributed DC Power + Signal	2.250" [57.15mm]	Solder	No
3P/24S/3P	6450130-6	Distributed DC Power + Signal	2.750" [69.85mm]	Solder	Yes
4P/24S/3ACP	6450130-4	AC and DC Power + Signal	3.150" [80.01mm]	Solder	Yes
3ACP/24S/5P	6450130-3	AC and DC Power	3.400" [86.36mm]	Solder	Yes
3ACP/24S/6P	1-6450130-4	AC and DC Power + Signal	3.650" [92.71mm]	Solder	Yes
5P/24S/6P	6450230-1	SSI "DPS"	4.350" [110.49mm]	Solder	Yes
5P/32S/5P	2-6450120-4	Distributed DC Power + Signal	3.950" [100.33mm]	Solder	No
6P/24S/6P	2-6450120-7	Distributed DC Power + Signal	4.250" [107.95mm]	Solder	No
8P/32S/8P	6450120-1	Distributed DC Power + Signal	5.450" [138.43mm]	Solder	No
10P/84S/10P	6450120-6	Distributed DC Power + Signal	7.750" [196.85mm]	Solder	No
10P/24S/12P	4-6450130-6	Distributed DC Power + Signal	5.800" [147.32mm]	Solder	Yes
16S/4P	6450231-1	Distributed DC Power + Signal	2.050" [52.07mm]	Solder	Yes
24S/6P	6450131-7	Distributed DC Power + Signal	2.750" [69.85mm]	Solder	Yes
24S/3ACP	6450121-3	Distributed DC Power + Signal	2.200" [55.88mm]	Solder	No
3ACP	6450123-3	AC Power	1.550" [39.37mm]	Solder	N/A
3P	6450123-1	DC Power	1.400" [35.56mm]	Solder	N/A
4P	6450123-2	DC Power	1.650" [41.91mm]	Solder	N/A
5P	6450123-6	DC Power	1.900" [48.26mm]	Solder	N/A
6P	6450523-2	DC Power	2.050" [52.07mm]	Press-fit	N/A
7P	6450123-5	DC Power	2.400" [60.96mm]	Solder	N/A
8P/28S	6450132-3	Distributed DC Power + Signal	3.350" [85.09mm]	Solder	Yes
14P/32S	6450132-4	Distributed DC Power + Signal	4.950" [125.73mm]	Solder	Yes

* Custom configurations are available — see page 28 for instructions to have Tyco Electronics build your custom part.

Vertical Plugs

Configuration *	Part Number	Application	Overall Length " and [mm]	PCB Tail Type (Solder, Press-Fit)	Signal Contact Sequencing
1P/16S/1P	6600333-9	Distributed DC Power + Signal	1.650" [41.91mm]	Press-fit	Yes
1P/24S/1P	6600330-4	SSI "DPS"	1.925" [48.90mm]	Solder	Yes
2P/16S/2P	1-6600333-0	Distributed DC Power + Signal	2.150" [54.61mm]	Press-fit	Yes
2P/24S/2P	1-6600333-2	Distributed DC Power + Signal	2.250" [57.15mm]	Press-fit	Yes
3P/16S/3P	6600333-7	Distributed DC Power + Signal	2.650" [67.31mm]	Press-fit	Yes
3ACP/24S/3ACP	1-6600333-1	AC Power + Signal	3.150" [80.01mm]	Press-fit	No
4P/24S/4P	6600333-6	Distributed DC Power + Signal	3.350" [85.09mm]	Press-fit	Yes
5ACP/24S/5ACP	6600333-1	Distributed DC Power + Signal	4.350" [110.49mm]	Press-fit	Yes
7P/32S/7P	6600330-5	Distributed DC Power + Signal	4.350" [110.49mm]	Solder	No
24S/8P	6600323-2	Distributed DC Power + Signal	3.250" [82.55mm]	Press-fit	No
3ACP	6450503-3	AC Power	1.550" [39.37mm]	Press-fit	N/A
8P	6600303-1	DC Power	2.650" [67.31mm]	Press-fit	N/A

* Custom configurations are available — see page 28 for instructions to have Tyco Electronics build your custom part.

Note: All part numbers are RoHS compliant.

MULTI-BEAM XL Power Distribution Connector System (Continued)

Board Mount Connectors

Specifications

Materials

Housing — High temperature thermo-plastic, UL 94V-0

Power Contacts — High conductivity Copper alloy

Signal Contacts — Copper alloy

Boardlocks — Phosphor bronze

Finish

Power and Signal Contacts — 30 microinches [7.6 micrometers] min. gold over 50 microinches [1.27 micrometers] min. nickel on mating surfaces, 100 microinches [2.54 micrometers] min. tin over 50 microinches [1.27 micrometers] min. nickel at PCB terminations

Note: Tin-lead plating also available on press-fit connectors

Performance Specifications

Up to 55 Amps per power contact, de-rated to 35 Amps in equally energized (8 adjacent positions) connector.

Up to 4 Amps per signal contact, de-rated to 1.5 Amps in equally energized 24-position pin field.

Maximum Continuous Operating Temperature — 105°C.

Contact Resistance — 0.7 milli-ohm

Durability — 250 cycle

Radial Mis-alignment Capability — ± 0.075" [1.91mm]

Minimum of 0.100" [2.45mm] of contact wipe on shortest signal contact

Board-to-Board Products

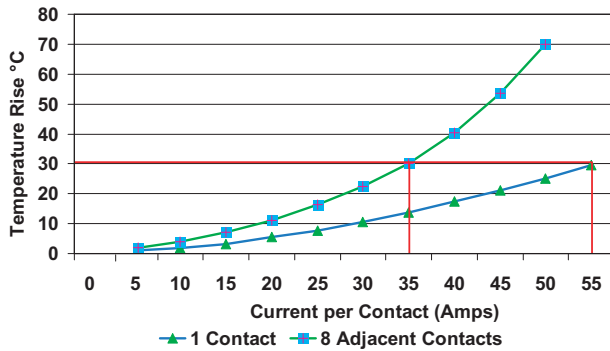

Performance @ 30 Amps per Contact

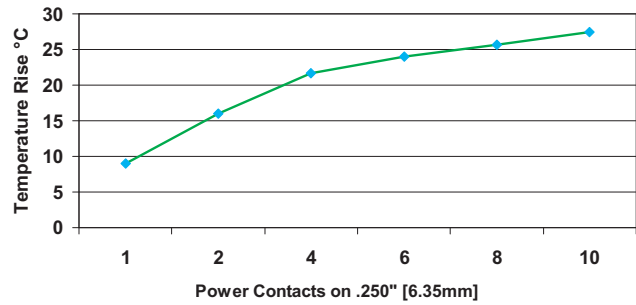

See Cable Connectors on Pages 18-27

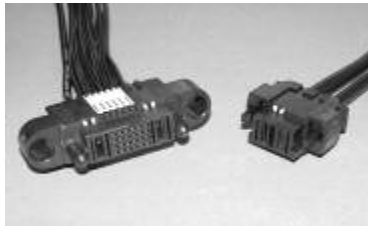
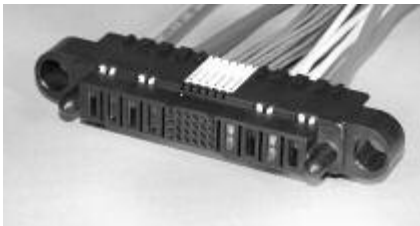

“NEW” MULTI-BEAM XL Current Pass-Thru Power Distribution Connector System

Product Facts

- Combines PCB and Cable mounted contacts
- Ideal for separating AC input from DC input
- Eliminates FASTON tab interface at the back of the connector housing
- Requires less space than two housing designs
- Terminates 14 AWG up to 8 AWG wire
- Mates with Tyco Electronics Vertical and Right Angle PCB plugs
- High strength housing materials
- RoHS Compliant

Technical Documents

Product Specification —
108-1973 and 108-2157

Application Specification —
114-13038



The Cable Pass-Through MULTI-BEAM XL receptacles securely terminate up to a 10 AWG wire directly into MULTI-BEAM XL pcb mounted receptacles. The design includes a “terminal position assurance” (TPA) feature that ensures the manually inserted wires are fully seated. The product offers a unique way of using the MULTI-BEAM XL pcb receptacles as a sort of “docking” connector. A single docking connector is far easier to mate to and to design around in a blind-mate application, than multiple power and signal connectors. By separating

some circuits to be cable terminated and some to be pcb terminated it allows both high voltage (AC) and low voltage (DC) power to pass through the same connector.

This separation of the AC and DC power eliminates the concerns of high voltage power running through circuit boards better suited to carry only low voltage circuitry. Additional applications may include designs where the power is better routed directly to a different pcb, through cables, yet pass through a single docking connector for ease in system design.

The Cable Pass-Through connector is offered in both right angle or vertical pcb mount orientations and is supplied with either press-fit or solder pc tails. The connector is mate-able to either pcb mounted or cable mounted MULTI-BEAM XL or MULTI-BEAM XLE plugs. All MULTI-BEAM XL cable connectors are supplied pre-assembled by Tyco Electronics.

**“NEW” MULTI-BEAM XL Current Pass-Thru
Power Distribution Connector System** (Continued)

Available Configurations	Part Numbers			
	Right Angle Receptacles	Right Angle Plugs	Vertical Receptacles	Vertical Plugs
3CP/1P/24S/2P	6450178-1	6450130-2	—	—
3CP/24S/2P	6450178-2	2-6450130-6	—	—
3CP/24S/3ACP	1888179-1	2-6450330-6	—	—
3CP/4P/24S	6450578-1	1-6450132-3	6450558-1	6600310-5
3ACP/24S/6P	—	1-6450130-4	6450558-2	—
3CP/8P/12S	1888132-1	—	—	—
3CP/20S/10P	6450578-2	6-6450130-2	—	—
3CP/16S	6450668-1	6450622-1	—	—

Note: Receptacles are the only MULTI-BEAM XL parts with Pass-Thru capability.

Configuration Description

CP	ACP	P	HDP	S
AC Power	AC Power	DC Power	High Density Power	Signal
Cable Power .300" spacing	PC Mount .300" spacing	PC Mount .250" spacing	PC Mount .200" spacing	PC Mount .100" grid

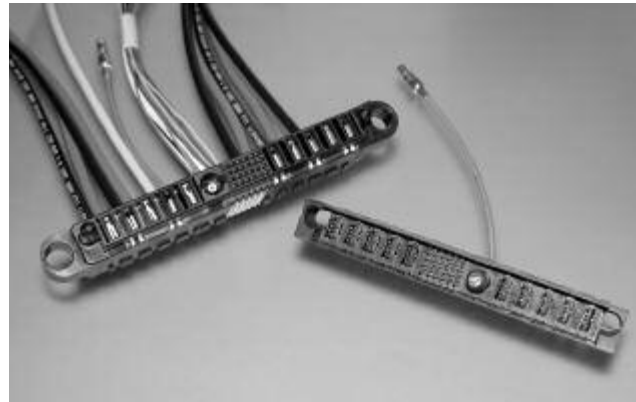

**“NEW” MULTI-BEAM XL Coax Pass-Thru
Combine power, coax and signal all in one connector**

Right Angle Plug	Cable Receptacle
292495-1	292491-1

Note: All part numbers are RoHS compliant.

MULTI-BEAM XL Power Distribution Connector System Cable Receptacle Assemblies

Cable Receptacle Assemblies

Product Facts

- Single one-piece housing design
- Terminal Position Assurance (TPA) Secondary Locks on contacts assure no contact back-out
- Pre-assembled made-to-order cable assemblies
- Installation to panel provides float in X, Y and Z directions
- Insulation crimp on all contacts
- 30 microinch (.76 micrometers) gold plated contacts for high reliability
- Touch-safe design passes UL1977 and IEC 60950 finger probe test
- AC and DC power in the same connector — meets UL & IEC safety requirements
- All MULTI-BEAM XL products in this section are RoHS compliant

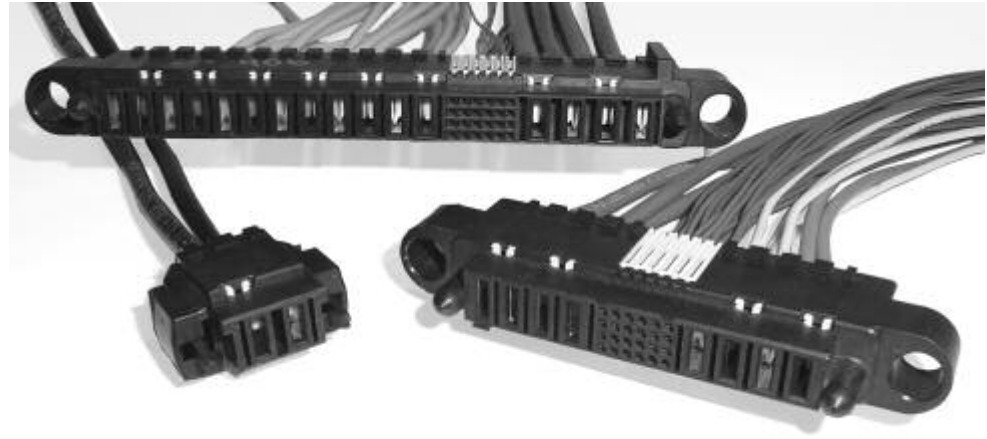

MULTI-BEAM XL Cable Assemblies allow designers freedom to connect power supplies and power distribution subassemblies in a wide variety of applications. Expanding beyond board-to-board applications the cable assemblies are available for both cable-to-board or panel mount applications and can terminate 8-16 AWG and 22-26 AWG wires all in one connector, without using adapter circuit boards. In addition, the power contacts are designed to be able to accept two-wire terminations which can further reduce harness complexity by reducing or eliminating mid-wire splices.

The use of high temperature glass filled housing materials, redundant contact retention and high conductivity contact materials allows the use of this connector in very high current density applications. The features work together to result in a highly durable and compact power connector, which offers industry leading minimum millivolt drop through the connection. The connector was designed to pass the UL 1977 and IEC 60950 finger probe test which makes the connector touch-safe. The insulation crimp adds further safety by keeping the insulation from being pulled away from the termination point. These features eliminate the

need for a secondary cable clamp which often can be size prohibitive.

The cable connectors are designed to mate to the de-facto standard Tyco Electronics MULTI-BEAM XL Right Angle or Vertical PCB Plugs. The combination of pcb and cable connections, both with mixed power and signal arrangements provides a universal power distribution connector systems.

The cable assemblies are all RoHS compliant, designed to specific customer requirements and manufactured in Tyco Electronics' cable assembly manufacturing facilities.

Technical Documents

Product Specification —
108-2157

Application Specification —
114-13112

For More Information

Internet <http://tycoelectronics.com>

Check out product information at: <http://mbxl.tycoelectronics.com>

Technical Support Center 1-800-522-6752

MULTI-BEAM XL Power Distribution Connector System
Cable Receptacle Assemblies (Continued)

Configurations/Applications

Floating XYZ Panel-Mount Receptacle

- 0.060" [1.52] Nominal Float in X, Y and Z direction
- For modular installation of large power distribution systems
- Single connector replaces multiple power and signal connectors

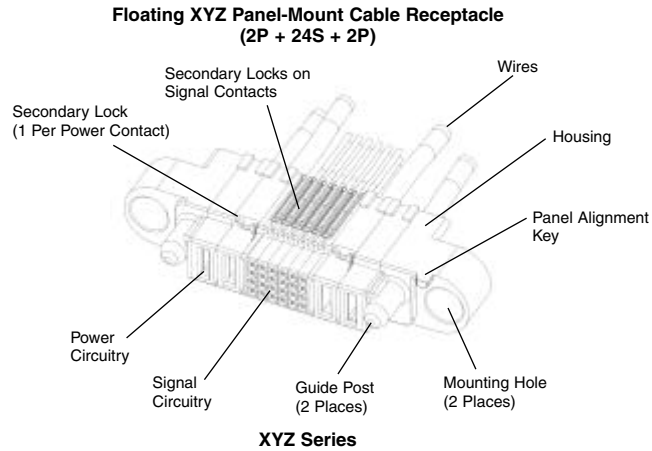

Slide-to-Lock Receptacle

- 0.030" [0.76] nominal float in X and Y direction
- Ideal for modular installation of smaller systems requiring less space and less float — such as fan trays
- Replaces connectors which use multiple low power contacts to carry the total current
- Power only or Power Plus signal mixed

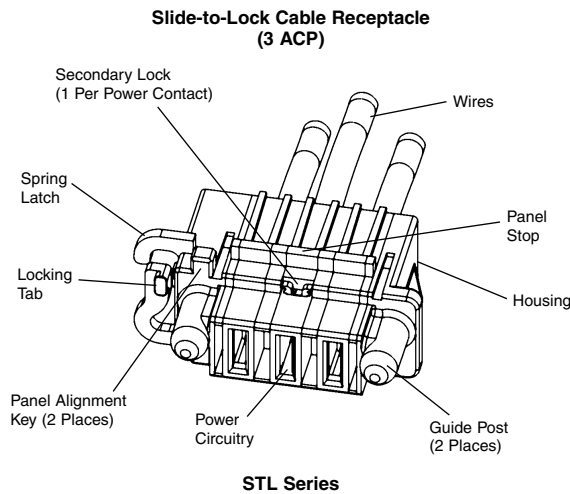

Cable-to-Board Receptacle

- Easy to mate/disconnect with squeeze-to-release latches
- Mates to right angle or vertical MULTI-BEAM XL STR plugs
- Replaces two traditional connectors (1 signal and 1 power) with just 1 connector

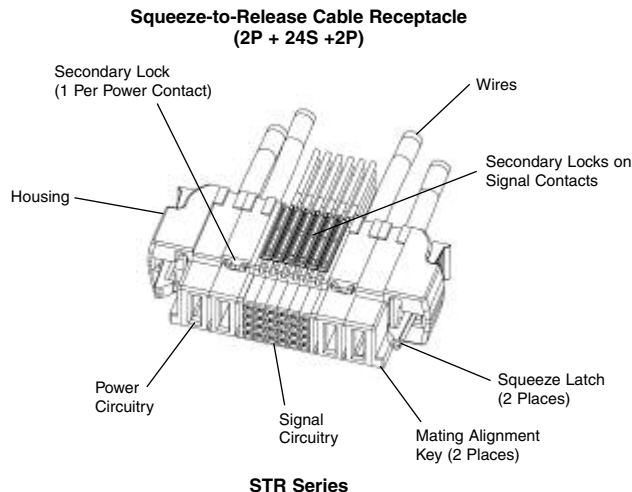

**MULTI-BEAM XL Power Distribution Connector System
Cable Receptacle Assemblies** (Continued)

Panel Mount Receptacles

Product Facts

- High strength glass-filled housing materials
- Expandable/modular housing design
- PMT Series floats +/- 0.060" [1.52] in X, Y and Z directions
- STL series floats 0.030" [0.76] in X and Y directions
- Mounting Hardware Kits:
Part Number 1600914-1 — Standard
Part Number 1600914-3 — High Force

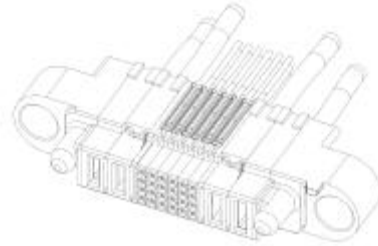

X, Y, Z Floating Receptacle

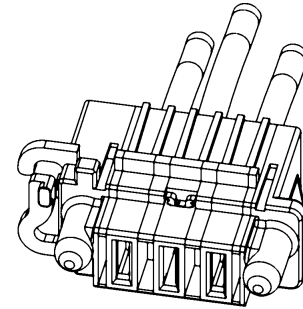

Slide-to-Lock Receptacle

Power and Signal Module Specifications

Power Module Widths:	Module Designation	Maximum Wire Size AWG [mm ²]	Max. Insulation Dia. inches [mm]
0.300 [7.62] (ACP)	300 (ACP)	8 [10.5]	0.272 [6.91]
0.250 [6.35] (P)	250 (P)	10 [6.6]	0.215 [5.46]
0.200 [5.08] (HDP)	200 (HDP)	12 [2.6]	0.156 [3.96]

Signal Module Width	Module Designation	Wire Range AWG [mm ²]	Insulation Range inches [mm]
0.200 [5.08] (8 Contacts)	Signals	22-26 [0.14-0.32]	0.036-0.054 [0.91-1.37]

Part numbers shown identify the main receptacle connector housing. Additional components (contacts, contact locks, etc.) are used to complete the cable assembly. See page 22 for contacts, secondary locks and application equipment information.

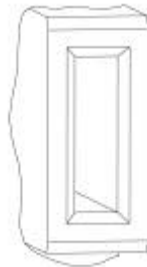

Power Module

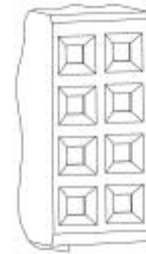

Signal Module

Configurations/Part Numbers

Available Configurations	Part Numbers			
	XYZ Series	STL Series	Mating PCB Plugs	
			Vertical	Right Angle
3ACP	1600606-2	292499-1	6450503-3	6450123-3
4P	—	292499-4	6600303-2	6450123-2
4ACP	—	292499-3	6600303-3	—
5P	1600606-1	1761419-2	—	6450123-6
1P/16S/1P	1-1600636-3	1761819-4	6600333-9	—
1P/24S/1P	1600636-9	—	6600330-4	6450330-1
2P/16S/2P	1-1600636-0	—	1-6600333-0	—
2P/24S/2P	1600636-2	1761819-2	6600333-5	1-6450330-4
3P/16S/3P	1600636-8	—	6600333-7	—
3ACP/24S/3ACP	1-1600636-4	—	1-6600333-1	—
4P/24S/4P	1-1600636-5	—	6600333-6	—
5ACP/24S/5ACP	1600636-1	—	6600333-1	5-6450130-0
7P/48S/7P	1-1600636-6	—	—	3-6450120-4

Note: All part numbers are RoHS compliant.

MULTI-BEAM XL Power Distribution Connector System
Cable Receptacle Assemblies (Continued)

Cable-to-Board Squeeze-to-Release Receptacles

Product Facts

- High strength glass-filled housing
- Pre-installed squeeze-to-release latches.
- Expandable/Modular housing design
- Mates to Tyco Electronics Vertical or Right Angle PCB Plugs

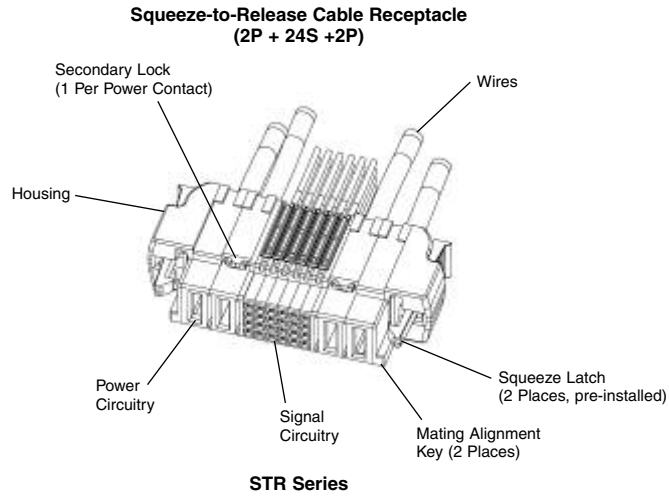

Technical Documents:

Product Specification — 108-2157

Application Specification — 114-13112

See page 22 for contacts, secondary locks and application equipment information.

Power and Signal Module Specifications

Power Module Widths:	Module Designation	Maximum Wire Size AWG [mm ²]	Max. Insulation Dia. inches [mm]
0.300 [7.62] (ACP)	300 (ACP)	8 [10.5]	.272 [6.91]
0.250 [6.35] (P)	250 (P)	10 [6.6]	.215 [5.46]
0.200 [5.08] (HDP)	200 (HDP)	12 [2.6]	.156 [3.96]
Signal Module Width	Module Designation	Wire Range AWG [mm ²]	Insulation Range inches [mm]
0.200 [5.08] (8 Contacts)	Signals	22-26 [0.14-0.32]	.036-.054 [0.91-1.37]

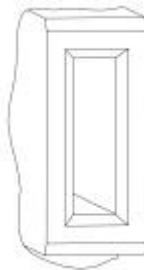

Power Module

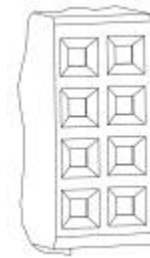

Signal Module

Configurations/Part Numbers

Available Configurations	STR Series	Part Numbers	
		Vertical	Right Angle
2ACP	1600798-2	6600393-1	6450129-1
3P	1600798-3	6600393-2	6450129-2
3ACP	1600798-5	—	—
4P	1600798-4	6600390-1	6450129-3
6P	1600798-1	6600393-3	—
1P/24S/1P	1600788-8	6600380-2	6450128-1
2P/8S/2P	1-1600788-3	—	6450128-6
2P/16S/2P	1-1600788-0	6600383-5	—
2P/24S/2P	1600788-1	6600383-3	6450128-2
3ACP/24S/3ACP	1-1600788-2	6600383-6	—
4P/24S/4P	1-1600788-4	6600383-7	6450128-5

Note: All part numbers are RoHS compliant.

MULTI-BEAM XL Power Distribution Connector System
Cable Receptacle Assemblies (Continued)

Cable Receptacle Components

Material and Finish

Body — 50 micro inches Nickel over Tin

Mating Area — 30 micro inches Gold over Nickel

Technical Documents

Product Specification
108-2157-1

Application Specification
114-13164

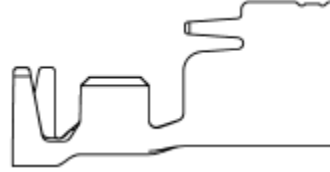

Power Contact

Power Contacts

Wire Size Range AWG	Insulation Diameter	Plating	Housing Width	Part Number	Applicator Tool
12	.156 Max. [3.96]	Tin	.200 or .250 [5.08 or 6.35]	1-1600961-7 (make-first-break-last)	1385635-3
	.156-.176 [3.96-4.47]	Tin	.250 [6.35]		1385636-3
14	.120-.156 [3.05-3.96]	Tin	.200 or .250 [5.08 or 6.35]	1-1600961-8 (Standard)	1385635-3
2 @ 16	.090 Max. [2.29]	Tin	.250 [6.35]		1385636-3

Wire Size Range AWG	Insulation Diameter	Plating	Housing Width	Part Number	Applicator Tool
8	.215-.272 [5.46-6.91]	Tin	.300 [7.62]		1385637-3
10	.176-.215 [4.47-5.46]	Tin	.200 or .300 [6.35 or 7.62]	1-1600960-7 (make-first-break-last)	1385638-3
2 @ 12	.130 Max. [3.30]	Tin	.300 [7.62]	1-1600960-8 (Standard)	1385637-3
2 @ 14	.137 Max. [3.48]	Tin	.300 [7.62]		1385637-3

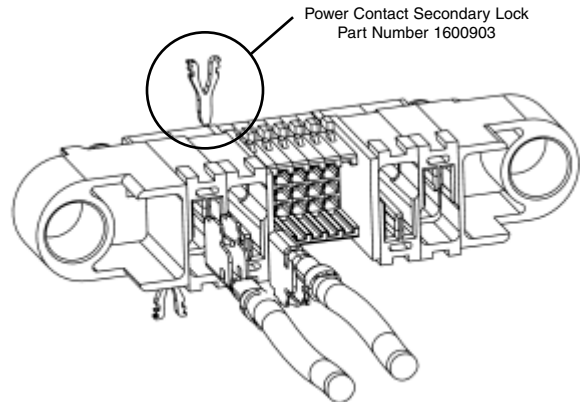
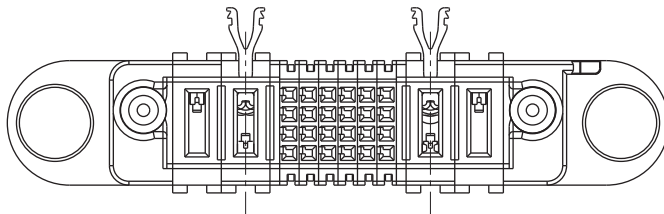

Secondary Power Locks:
Part Number 1600903-X

Note: One secondary lock needed for each power contact.

Note: All part numbers are RoHS compliant.

MULTI-BEAM XL Power Distribution Connector System
Cable Receptacle Assemblies (Continued)

Cable Receptacle Components (Continued)

Material and Finish

Contact — Phosphor bronze plated gold over nickel in mating area

Technical Documents

Product Specification

108-25031

Application Specification

114-25021

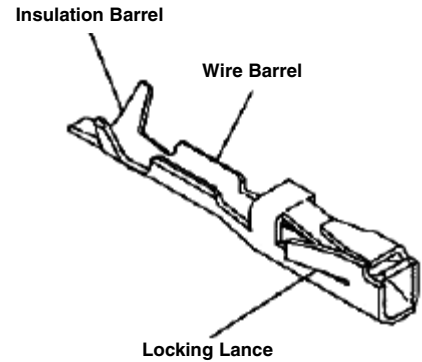
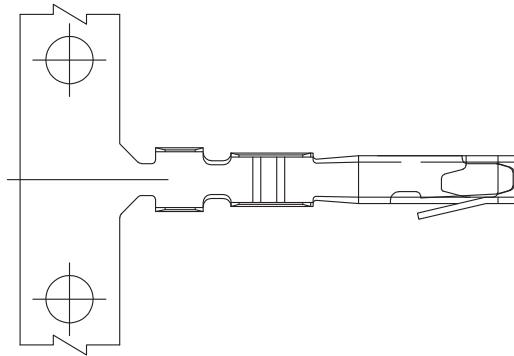

Signal Contacts

Wire Size Range AWG	Insulation Diameter	Version	Part Number	Extraction Tool
22-26	.036-.054 [0.91-1.37]	Low Pressure	531216-5 (reel)	91156-2
	.036-.054 [0.91-1.37]	High Pressure	531224-6 (reel)	91156-2

Secondary Locks

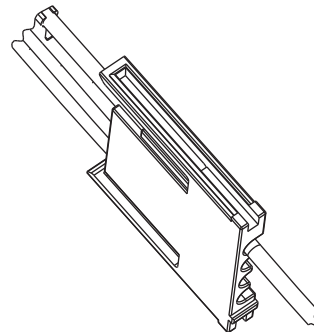
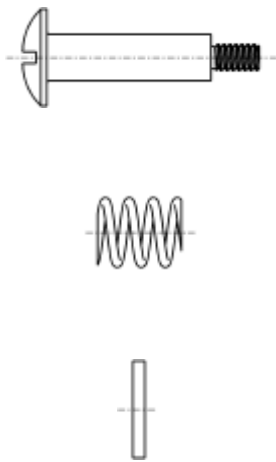

Note: One secondary lock needed for each column of signal contacts

Secondary Signal Locks:
Part Number 1600902-X

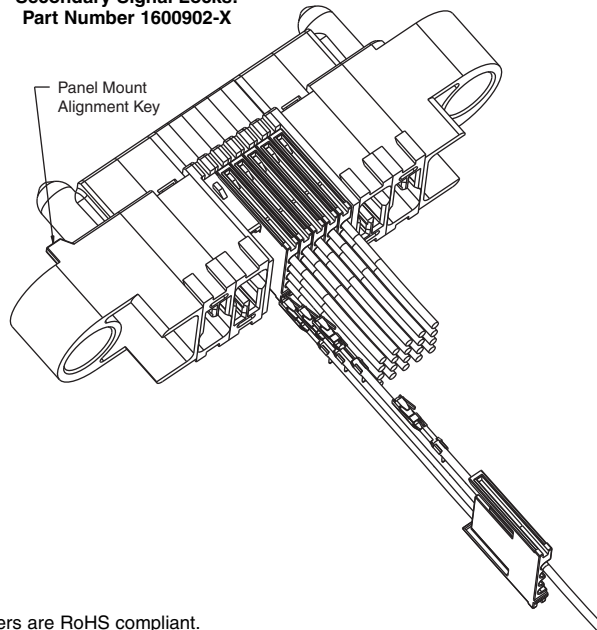

Float Mount Hardware Kit
Part Number 1600914-1
(Standard Force)
Part Number 1600914-3
(High Force)
1 Kit / Cable Assembly;
Kit includes 2 screws, 2 washers
and 2 springs

Note: Kit not needed for STR or STL housings

Note: All part numbers are RoHS compliant.

MULTI-BEAM XL Power Distribution Connector System
Cable Receptacle Assemblies (Continued)

Specifications

Product Specifications

Power Contacts —
 50 Amps on single 8 AWG wire

Signal Contacts —
 5 Amps on single 22 AWG wire
 0.050" [1.27] minimum float in X,
 Y and Z direction

Sequenced Mating —
 3 Levels Pwr/Grnd, Pwr & Signal,
 Signal 250 Cycle Durability

Installed Connector Illustration

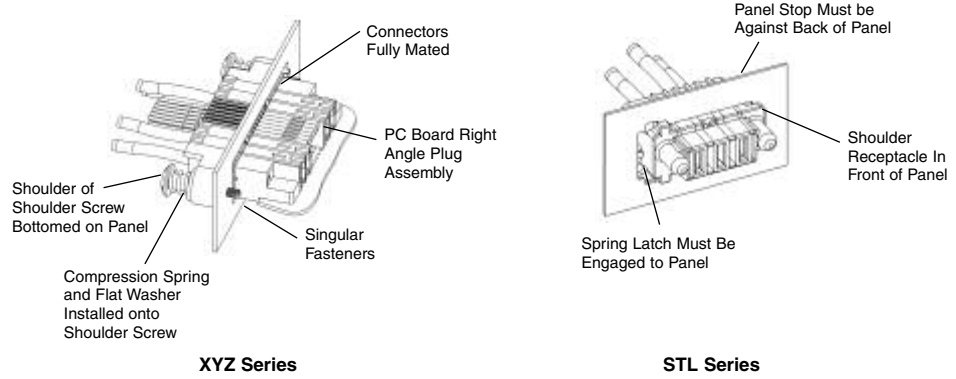

XYZ Series

STL Series

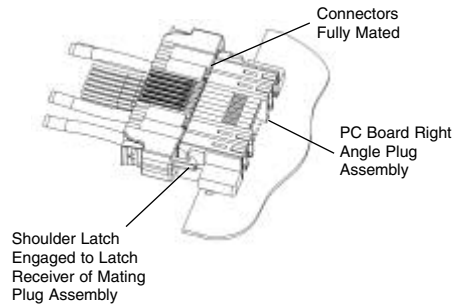

STR Series

Additional temperature-rise data available, contact Tyco Electronics Product Engineering.

Current/temperature rise data shown — from End-Of-Life qualification test.

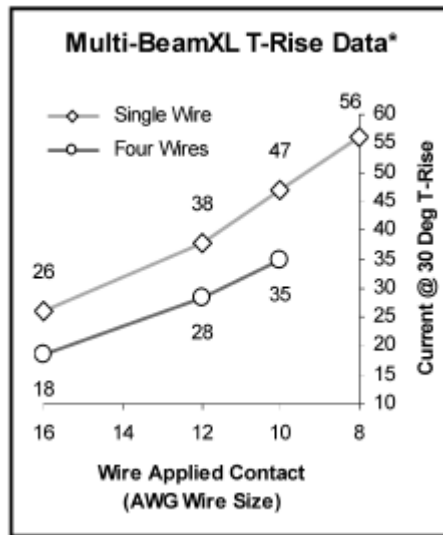

For more information see the product website @ <http://mbxl.tycoelectronics.com>

“NEW” MULTI-BEAM XL Power Distribution Connector System Cable Plug Assemblies

Cable Plug Assemblies

Product Facts

- High strength housing materials
- Hot-Pluggable
- Installation provides float in X, Y and Z directions
- Sequenced mating
- RoHS complaint
- Modular mold design provides configuration flexibility
- Integral cable clamp supports contacts and provides strain relief in minimum amount of space
- 30 microinch (0.76 micrometers) gold plated contacts for high reliability
- Sold only as part of a pre-assembled cable assembly



The newest addition to the MULTI-BEAM XL cable assemblies are the cable mounted plugs. Produced with modular molds, the connectors can be made in a wide variety of sizes. The pcb mounted MULTI-BEAM XL plugs are typically rigidly mounted to hot-swappable power supplies and the systems they connect with. The “float blind-mate drawer connector” design of the MULTI-BEAM XL cable connectors eliminates the concern of an inadequately aligned chassis. The connector can accept mating parts misaligned by as much as 3mm (± 1.5 mm), and still mate without

applying stress to solder or complaint pin terminations. The MULTI-BEAM cable plugs can terminate 8-14 AWG and 22-26 AWG wires all in one connector, without using adapter circuit boards. The use of high temperature glass filled housing materials, redundant contact retention and high conductivity contact materials allows the use of this connector in very high density applications.

The cable assemblies are all RoHS compliant designed to specific customer requirements and manufactured in Tyco Electronics’ internal cable assembly manufacturing facilities.

Technical Documents

Product Specifications —
108-2157-1

Application Specifications —
114-13164

For More Information

Internet
<http://tycoelectronics.com>

Check out product information at:
<http://mbxl.tycoelectronics.com>

Technical Support Center
1-800-522-6752

“NEW” MULTI-BEAM XL Power Distribution Connector System
Cable Plug Assemblies (Continued)

**Configurations/
Part Numbers**

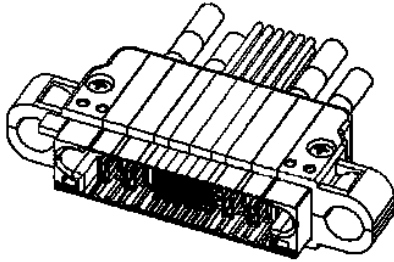

PMT

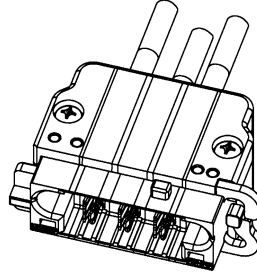

STL

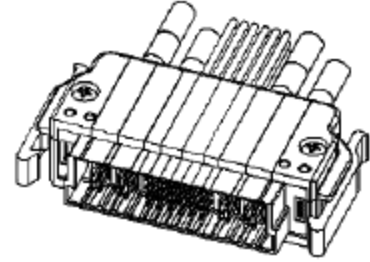

STR

Power Module Widths:

0.300" (ACP)
0.250" (P)
0.200" (HDP)

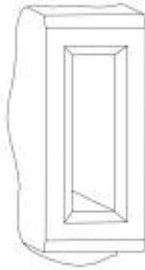

Module Designation	Maximum Wire Size		Max. Insulation Dia.
	AWG	mm ²	
300 (ACP)	8	10.5	.272 6.91
250 (P)	10	6.6	.215 5.46
200 (HDP)	12	2.6	.156 3.96

Signal Module Width:

0.200" (8 Contacts)

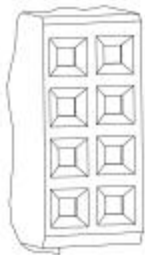

Module Designation	Maximum Wire Size		Max. Insulation Dia.
	AWG	mm ²	
Signals	22-26	0.14-0.32	.036-.054 0.91-1.37

Configuration	PMT Series Plug	STL Series Plug	Mating Receptacles*		STR Series Plug	Mating Receptacles Vertical
			Vertical	Right Angle		
3 ACP	—	1761421-1	6450543-6	6450173-1	—	—
4 P	—	1761421-3	6450543-5	—	1600814-2	—
1P/16S/1P	1600236-5	1600820-2	—	2-6450170-0	1600238-4	6450740-4
1P/24S/1P	1600236-4	1600820-1	6450540-1	6450160-3	1600238-3	6450740-5
2P/24S/2P	1600236-6	1600820-3	—	2-6450170-1	1600238-5	6450740-6
3ACP/24S/3ACP	1600236-7	1600820-4	4-6450550-1	2-6450170-2	1600238-6	6450740-7

PMT Series — Panel Mount with total 3mm float in X,Y and Z directions
 STL Series — Panel Mount with total 1.5mm float in X and Y directions
 STR Series — Squeeze-to-Release for removeable Cable-to-Board / I/O Applications
 *Specifications on mating pcb mountable receptacles:
 Product Specification — 108-2157-1
 Application Specification — 114-13164

Note: All part numbers are RoHS compliant.

**“NEW” MULTI-BEAM XL Power Distribution Connector System
Cable Plug Assemblies (Continued)**

Connector Styles

Intermateable with Tyco Electronics MULTI-BEAM XL pcb mounted receptacles

Specifications

Wire Gauge — 8 AWG – 14 AWG

Sequenced Mating — 3 Levels: Pwr/Gnd, Pwr & Signal, Signal

Current Carrying Capacity — Power Contacts — 45 Amps* on single 8 AWG wire
Signal Contacts — 4 Amps on single 22 AWG wire

Durability — 250 Cycle

Temperature Range — 40°C – 105°C

Float — 1.5mm float in X, Y, and Z Direction**

RoHS Compliant

UL, CSA, VDE Approvals Pending

*Based on End-of-Design Life Qualification Tests

**Mated to Tyco Electronics MULTI-BEAM XL receptacles only

PMT (Panel Mount) for True X, Y, Z Floating

- Single-piece contact design — eliminates multiple contact interfaces
- Insulation crimp on all contacts
- Installation to panel provides float in X, Y and Z directions

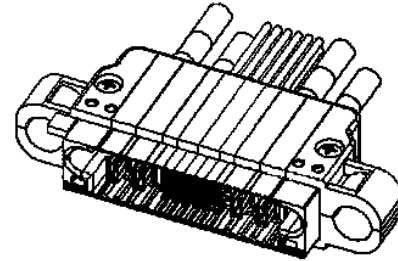

STL (Slide-to-Lock) — Most Economical — Still Offering X and Y Floating

- Single-piece contact design — eliminates multiple contact interfaces
- Insulation crimp on all contacts
- Installation to panel provides float in X and Y directions

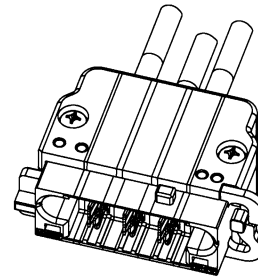

STR (Squeeze-to-Release) — To Connect Sub-assemblies

- Single-piece contact design — eliminates multiple contact interfaces
- Insulation crimp on all contacts
- Easy to mate/disconnect with squeeze-to-release latches

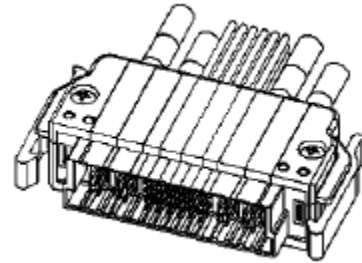

- Offered as pre-assembled, fully tested cable assemblies, as shown below
- Combines multiple power and signal connectors into a single Power I/O Connector

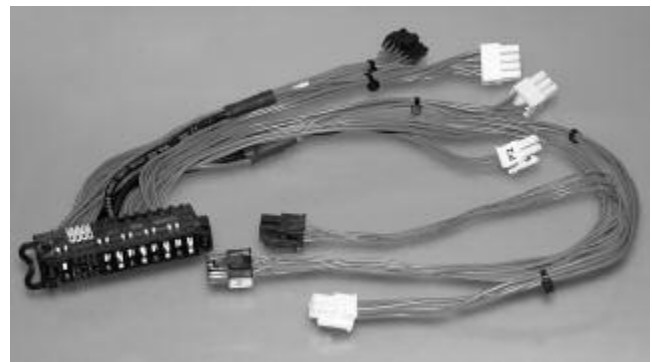
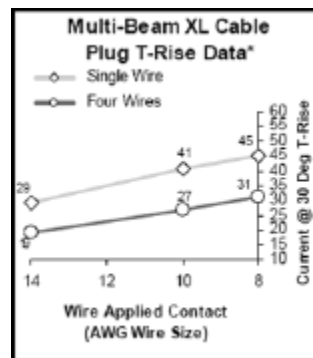

ELCON Drawer Series Connectors

True Hot-Plug, Blind-Mating Mixed Signal and Power Connectors

Product Facts

- High performance CROWN BAND contacts
- Low millivolt drop, minimal temperature rise
- Float mount for improved gatherability (blind mating)
- True hot-pluggability for current interruption under load
- Sequenced mating for power and signal
- Crimp, PCB tail, compliant press-fit and threaded terminations
- Meets safety regulatory requirements

Typical Applications

- Low noise power supplies
- Switch-mode power supplies (SMPS)
- Power factor-correcting (PFC) power supplies
- Systems requiring mounting to backplane or chassis
- Redundant (N + 1) power systems
- “Live” hot-plug power supplies
- All ELCON Drawer connectors in this section are RoHS compliant

Technical Documents

Product Specification
108-2285



The Drawer Series family of mixed power and signal connectors is designed for an unlimited array of applications that use drawer-type, true hot-plug power supply units. Contacts for AC IN and DC OUT power, logic and signal are all housed in robust one piece insulators that have built-in or optional mating guides for improved gatherability and mating polarization. Key features include Tyco Electronics high performance CROWN BAND contact, true hot-pluggability, sequenced mating, probe-proof contacts, and support for various termination styles.

Product Highlights

High Performance CROWN BAND Contact

Tyco Electronics ELCON CROWN BAND contact consists of a fingered barrel with the flexibility and conductivity to deliver excellent electrical and mechanical performance. This results in consistent insertion and extraction forces, and maximum surface contact area for low voltage drop and minimal heat generation.

Support for True hot-pluggability

True hot-pluggability is supported through the use of gold-plated size #12 contacts specially designed to achieve current interruption under load as defined by safety regulatory agencies. This contact has been evaluated and found to comply with UL and CSA safety regulatory standards.

Standard Contacts

Tyco Electronics ELCON Drawer Series connectors use standard contacts in all its housings, resulting in lower cost and fewer part numbers. Contacts are available in crimp, PCB tail, threaded and press-fit termination styles, meeting a wide range of connector mounting requirements.

Many Standard Designs

Numerous Drawer connectors have been tooled over the years and are available to all our customers for use in their applications. All these connectors can be configured with different contact layouts, terminations and mating sequencing schemes to meet application-specific requirements.

ELCON Drawer Series Connectors
True Hot-Plug, Blind-Mating Mixed Signal and Power Connectors (Continued)

Cable Mounted Products



3mm Diameter Test Probe in Accordance with IEC 435 Protective Cap (insulator)

Probe-proof Double CROWN BAND Contacts

The size #0 contacts used in the Top Drawer, Double Drawer, DualPower and QuadPower connectors are also available in a probe-proof Double CROWN BAND version. These contacts are specially suited for operator-serviced power supplies that require extra safety protection.

Signal/Power Sequencing

All signal and some power contacts are available in various lengths to allow multiple levels of sequencing, thus giving the engineer further design flexibility.

Mating Polarization

To ensure positive housing mating of connectors, polarization is provided in the form of molded-in guide posts or pre-installed guide pins.

Regulatory Agency Certifications

Tyco Electronics ELCON Drawer Series connectors have been evaluated and found to comply with the UL1977 standard and the CSA standard C22.2 No. 182.3-M1987.

Tyco Electronics can also work with the customer to obtain application-specific regulatory certifications if needed.



Wide Array of Standard Contacts

ELCON Drawer connectors support various termination styles, including crimp for cable, solder tail and compliant press-fit for mounting

to PCB, and internal/external threads for termination to lugs and/or busbars. See table below for details.

Contact Size	Termination				
	PC Tail	Press-fit	Crimp	Threaded	
				Internal	External
#20	•	•	•		
#16	•	•	•		
#12	•	•	•		
#8	•	•	•	•	•
#4			•	•	•
#0			•	•	•

Application-Specific Designs

If none of our standard Drawer connectors satisfies your requirements, Tyco Electronics can develop an ELCON connector design specific to your application. We will

work closely with your engineers to fully understand the design requirements and develop an interconnect solution that meets your exact needs. After the concept and design stages,

Tyco Electronics produces prototypes that perform both electrically and mechanically the same as production parts. These machined parts are used for testing, regulatory

agency evaluations and even as pre-production components, allowing the shortest lead time from concept to manufacturing in the industry.

Concept

Tyco Electronics engineers work closely with the customer to fully understand the design requirements.



Design

A sketch drawing of the design concept is created for customer review, and the design is finalized only when it fully meets the requirements of the customer.



Prototypes

The design frozen and work on the mold tools starts. Meanwhile, Tyco Electronics builds prototypes that are identical to the production parts.



Production

By the time the customer is ready for production, all requirements for release to production, such as qualification and regulatory agency approval, have been cleared.

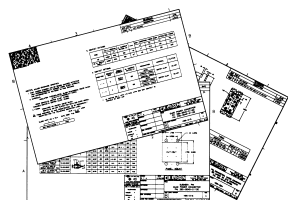

How to Tailor Your ELCON Drawer Connector

If you selected a standard Drawer connector for your application, before placing an order you need to specify your application-specific requirements, such as housing type, contact loading, and termination style. Layout forms for all standard Drawer connectors, such as the one shown below, are available online at <http://www.tycoelectronics.com> or can be obtained from Tyco Electronics customer service for

this purpose. Complete a form for the pin and socket side of your connector as indicated in the instructions and fax it to Tyco Electronics customer service. We will issue a unique part number specific to your configuration, which you can then use to place orders. Samples and Customer Drawings are also available upon request.

Pin Assembly

1. Choose one housing from the **Pin Housing Selection Menu** table. Place an X in the appropriate guide pin circles, if guide pins are required.
2. Write the total quantity of each pin contact you require for each pin assembly in the **Qty** column of the **Pin Contact Selection Menu** table.
3. Crimp contacts are shipped uninstalled. Threaded and PCB tail contacts are installed by Tyco Electronics; enter the letter reference of the desired contact in the appropriate contact positions on the drawing: e.g., if you need a size #20 premate PCB tail standard contact to be installed in contact position #10, write "Q" in circle #10.
4. Sign, date and send the completed form to your local Tyco Electronics Sales Engineer.

Pin Connector (Rear Face)

Pin Contact Insertion Side

Pin Connector Rear Face Cavity Identification

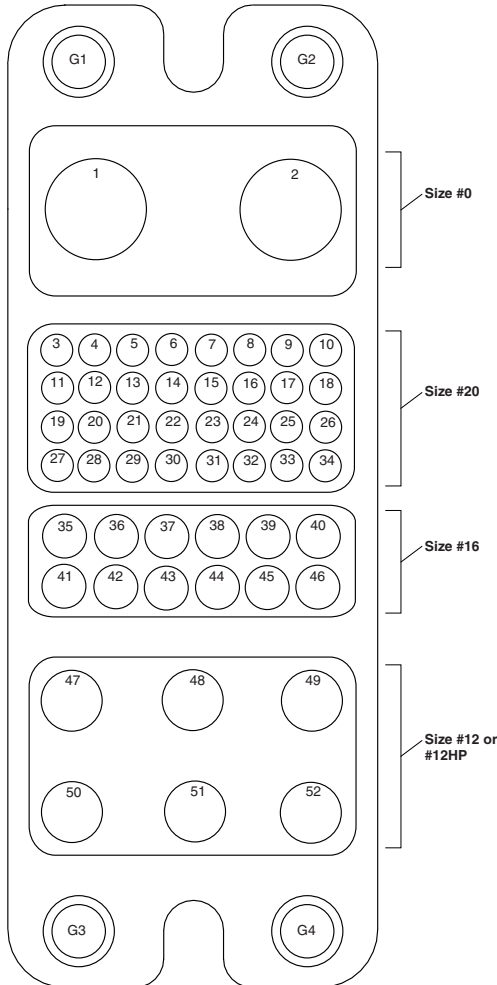

Top Assembly Part Number Assigned by Tyco Electronics

ENTER CUSTOMER INFORMATION	
Company	Location
Contact Name	Title
Telephone	Fax
Email Address	
I am: <input type="checkbox"/> End user <input type="checkbox"/> Contract manufacturer (end user: _____)	
Signature	Today's Date
	Annual Quantity Required

Submit to your local Tyco Electronics Sales Engineer.

Pin Housing Selection Menu		Check One
Part Number	Description	
1648183-1	Housing without guides	
	Housing with guides (#6-32 thread)	
	Housing with guides (M3 x 0.5 thread)	

Pin Contact Selection Menu				Qty.	
Size	Ref.	Part Number	Termination Style & Pin Length		
#0	A =	1766811-1	Crimp		
	B =	1766819-1	Probe Proof, crimp		
	C =	1766230-1	1/4-20 Internal Thread		
	D =	1766274-1	M6 x 1 Internal Thread		
	E =	1766269-1	Probe Proof, 1/4-20 Internal Thread		
	F =	1766275-1	Probe Proof, M6 x 1 Internal Thread		
	G =	1766268-1	1/4-20 External Thread		
	H =	1766231-1	M6 x 1 External Thread		
	J =	1766270-1	Probe Proof, 1/4-20 External Thread		
	K =	1766276-1	Probe Proof, M6 x 1 External Thread		
	#20	L =	1650155-1	Crimp, standard	
M =		1650161-1	Crimp, premate		
N =		1650162-2	Crimp, postmate		
P =		1650283-1	PCB tail, standard		
Q =		1650065-1	PCB tail, premate		
R =		1650226-1	PCB tail, postmate		
S =		1766196-1	Crimp, standard		
T =		1766198-1	Crimp, premate		
#16	U =	1766199-2	Crimp, postmate		
	V =	1766222-1	PCB tail, standard		
	W =	1766223-1	PCB tail, premate		
	X =	1766818-1	PCB tail, postmate		
	Y =	1766193-1	Crimp, standard		
	Z =	1766195-1	Crimp, premate		
	AA =	1766196-1	Crimp, postmate		
	AB =	1766245-1	PCB tail, standard		
#12	AC =	1766250-1	PCB tail, premate		
	AD =	1766249-1	PCB tail, postmate		
	AE =	1650153-2	Crimp, standard, Hot-Plug		
	AF =	1650156-2	Crimp, premate, Hot-Plug		
	AG =	1650060-2	PCB tail, standard, Hot-Plug		
	AH =	1650074-3	PCB tail, premate, Hot-Plug		
	#12 Hot-Plug				

Crimp and Threaded contacts are removable. PCB tail contacts are non-removable.

Float Mount Shoulder Screw		Qty.
Part Number	Description	
1650399-1	Screw, No 10-32 UNC 2A	
1650401-1	Screw, M5 x 0.8	

ELCON Drawer Connector Mounting

All ELCON Drawer Series connectors can be fixed mounted or float mounted using the designated shoulder screws to allow improved gatherability for blind mating of the connector. Panel cut out dimensions are shown on the customer drawing specific to your ELCON Drawer connector.

Panel Float Mounting

When float-mounting to a panel or chassis, use the stainless steel shoulder screws specified in the layout sheet or customer drawing specific to your ELCON Drawer connector. Shown in the sketch below is an example of how the Top Drawer connector is float-mounted to a panel.

Float Mount of Top Drawer (Example)

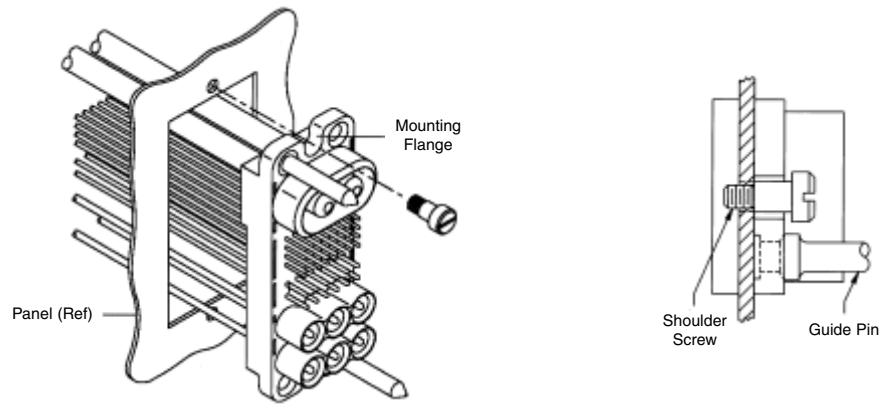

Screw Description	Part Number	Used On
#10-32 UNF 2A Thread	1650399-1	Top and Double Drawer, Dual and QuadPower, In-Line QuadPower, W5 Drawer
M5 x 0.8 Metric Thread	1650401-1	
#8-32 UNF 2A Thread	1650402-1	
#6-32 UNF 2A Thread	1650106-1	All Other Drawers
M4 x 0.7 Metric Thread	1650589-1	

Panel Fixed Mounting

As a rule of thumb, ELCON Drawer connectors can be fix-mounted to a panel, in two ways: (1) by attaching a screw through the top and bottom mounting flange of the housing; or (2) by attaching a screw into a threaded guide pin (for those connectors that have one). An example of each case is shown in the sketches below.

Screw Through Mounting Flange of Housing

Fix to the panel by attaching a commercially available screw and a washer through the top and bottom mounting flange of the housing.

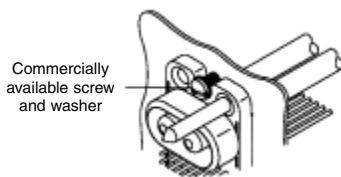

Screw Into Thread of Guide Pin (When Applicable)

You can optionally fix-mount housings that have a guide pin by attaching a commercially available screw and washer into the thread on the back of the guide pin, as shown in the figures below.

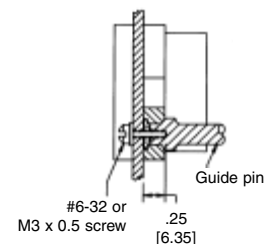
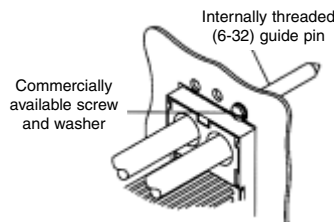

Note: All part numbers are RoHS compliant.

ELCON Drawer Connector Mounting (Continued)

Strain Relief and Wire Dress

If required, wires can be bundled together and supported with cable ties. Wires must not be stretched or confined in any way that would restrict the floating action of the connectors. Therefore, the wires must remain perpendicular to the connector and avoid an excessively sharp bend radius. The minimum recommended distance for the cable tie, and the minimum bend radius of a wire bundle are shown in the figure to the right.

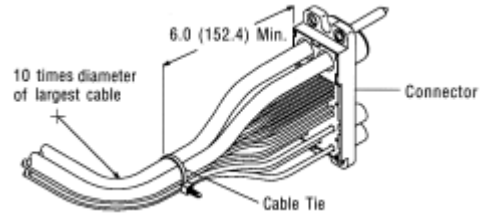

PCB Fixed Mounting

When mounting to a PC board, the connector standoffs must be seated on the board. Hold-downs are recommended to ensure stability during the soldering procedure. PCB mount hole patterns are shown on the customer drawing specific to your ELCON Drawer connector.

Flush PCB Mount Drawer Connectors

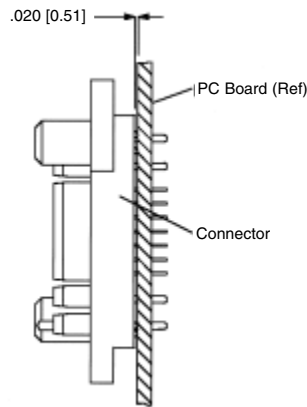

Drawer Connectors with Cabled AC IN

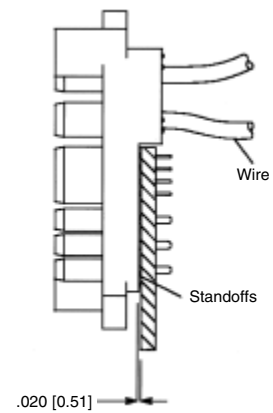

Connector Engagement

To ensure proper mating of the connector when the power supply unit is fully engaged into the system, the gap between the pin and socket (shown as dimension "A" in the sketch below) must be within the limit specified in the customer drawing for your ELCON Drawer connector. Failure to meet this requirement may compromise contact wipe. Refer to the customer drawing for details. ELCON Drawer connectors are polarized and will only mate in the correct orientation (see sketch below).

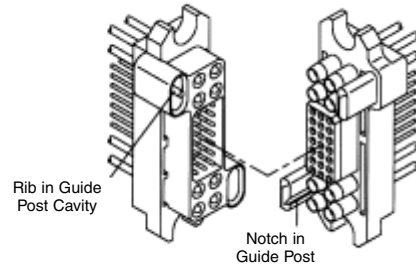
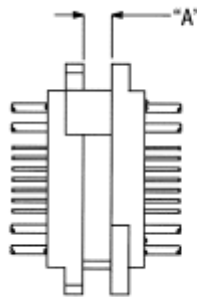

ELCON Drawer Connector Tooling

Insertion/Removal Tools: Industry standard plastic insertion/removal tooling is compatible with all crimp contacts for pin and socket removal. The following tools are available from Tyco Electronics.

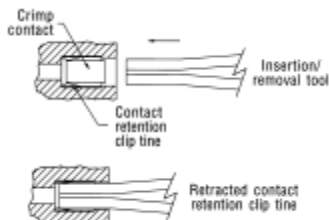

Insertion/removal tools available from ELCON

Part Numbers	Size	Color Code
1643917-1	Size #20 removal tool	Red/White
1643916-1	Size #16 I/R tool	Blue/White
1643915-1	Size #12 I/R tool	Yellow/White
1643914-1	Size #8 I/R tool	Red
1643922-1	Size #4 I/R tool	Blue
1643921-1	Size #0 removal tool	Light Yellow

Note: PCB tail contacts are non-removable.

Wire strip length: If inserting stranded wire into crimp style contacts, please use the table below to determine the proper strip length of the wire.

Contact Size	Wire Size AWG	"L" + .020 [0.51]	
		inches	mm
#20	#24 - #20	0.210	5.33
#16	#20 - #16	0.270	6.86
#12	#14 - #12	0.270	6.86
#8	#10* - #8	0.500	12.70
#4	#6* - #4	0.500	12.70
#0	#2* - #0	0.600	15.24

*Ref: MS3348 "Contact Bushing, Electric, Wire Barrel"

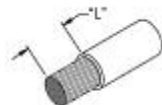

Crimp Tools: The following table lists applicable MIL-STD crimp tools for contacts

Size	Type	MIL-STD
12 - 24	Crimp Tool	M22520/1-01
	Turret head/locator	M22520/1-02
8 - 10	Crimp Tool	M22520/23-01
	Indenter head	M22520/23-02
	Locator	M22520/23-09
4	Crimp Tool	M22520/23-01
	Indenter head	M22520/23-04
	Locator	M22520/23-11
0	Crimp Tool	M22520/23-01
	Indenter head	M22520/23-05
	Locator	M22520/23-13

Crimp Termination Wire Sizes: The following table shows crimp rear release contacts and their respective wire sizes when crimped with applicable industry standard terminal tools.

Contact Size	Wire Range	
	AWG	mm ²
#20	20 - 24	0.241 - 0.616
#16	16 - 18	0.963 - 1.23
#12	12 - 14	1.94 - 2.98
#8	10 - 8	4.74 - 8.61
#4	4 (1)	21.60
#0	1/0	53.00

Note: (1) Consult Tyco Electronics for smaller wire sizes in #4 contacts

Note: All part numbers are RoHS compliant.

ELCON Drawer Product Specifications

Materials			
Housing	Polyester, 30% glass-filled, UL 94V-0 black		
Crimp Contacts	Copper alloy, C14500		
PCB Tails	Brass, CDA 36000		
Socket Contact Hoods (when applicable)	305 corrosion resistant steel		
Size #12 hoods, Hot-Plug	Beryllium copper, CDA 17300 HT		
Crown contacts	Beryllium copper, CDA 17200 HT		
Plating			
Size #20 and #12HP	Gold plated over nickel		
Sizes #0, #4, #8, #16 and non-HP #12	Silver plated over nickel		
Hot-Plug hoods and pin contacts	Gold plated over nickel		
Socket Contact Hoods (when applicable)	Passivated		
Mechanical			
Typical Insertion Forces of individual contacts	Size #20	0.2 lb.	0.09 kg
	Size #16	2.3 lb.	1.04 kg
	Size #12	2.9 lb.	1.32 kg
	Size #12 Hot-Plug	2.9 lb.	1.32 kg
	Size #8	4.4 lb.	2.00 kg
	Size #4	3.8 lb.	1.72 kg
	Size #0	4.7 lb.	2.13 kg
	Size #0 w/double Crown	4.8 lb.	2.18 kg
Typical Extraction Forces of individual contacts	Size #20	0.1 lb.	0.05 kg
	Size #16	0.7 lb.	0.32 kg
	Size #12	1.9 lb.	0.86 kg
	Size #12 Hot-Plug	1.9 lb.	0.86 kg
	Size #8	2.4 lb.	1.07 kg
	Size #4	3.0 lb.	1.36 kg
	Size #0	3.0 lb.	1.36 kg
	Size #0 w/double Crown	3.5 lb.	1.59 kg
Electrical			
Typical Voltage drop of individual contacts	Size #20	1.7 mV at 5A	
	Size #16	3 mV at 15A	
	Size #12	4.2 mV at 35A	
	Size #12 Hot-Plug	4.7 mV at 35A	
	Size #8	6.5 mV at 75 A	
	Size #4	8.4 mV at 125A	
	Size #0	6.3 mV at 200A	
	Size #0 w/double Crown	5.6 mV at 200A	
Insulator dielectric strength	1,500 VDC for 1 minute, per MIL-STD 1344, Method 3001		

Regulatory Agency Evaluations

Contacts	CSA-22.2 No. 0-M91 182.30 M1987 (CNR)	UL 498 and UL 1977 (USR)
AWG #20	4A / 250V	5A / 250V
AWG #16	10A / 250V	15A / 250V
AWG #12 Top Drawer	25A / 600V	35A / 600V
AWG #12 Others	25A / 250V	35A / 250V
AWG #12 with sockets	25A / 250V	35A / 250V
Size #12 hot-plug	25A / 250V	25A / 250VAC
		35A / 120V
Size #8	55A / 250V	75A / 250V
Size #0 with single or double Crown	150A / 250V	200A / 250V
Size #0 using bus bar	—	200A / 250V
Size #4	100A / 250V	125A / 250V

ELCON Drawer Series Connectors

Mini Drawer

Dimensions —
2.99" x 0.79" (75.9 x 20.1 mm)

Housing Variations — See Part Numbers

Guides and Polarization — Built in

Available Contacts —
Size 12 / 16 x 6 contacts
Size 20 x 16 contacts

Current Rating — Up to 35 Amps per size 12 contact

Contact Features — Hot-Plug size 12 contact option

Contact Sequencing — Multi-level for power and signal

Contact Terminations —
Size 12: Crimp and PCB tail
Size 16: Crimp and PCB tail
Size 20: Crimp and PCB tail

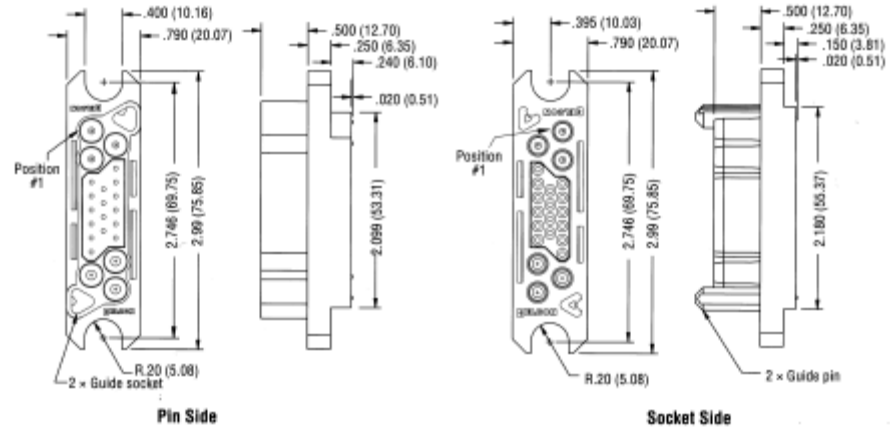

Base Housing Part Numbers

Pin Housing		Socket Housing	
1648110-1	Size 12 + Size 20 + Size 12	1648115-1	Size 12 + Size 20 + Size 12
1648111-1	Size 16 + Size 20 + Size 16	1648116-1	Size 16 + Size 20 + Size 16
1648112-1	Size 12 + Size 20 + Size 16	1648117-1	Size 12 + Size 20 + Size 16

Lower Drawer

Dimensions —
3.26" x 1.34" (82.8 x 34.0 mm)

Housing Variations — See Part Numbers

Guides and Polarization — Built in

Available Contacts —
Size 12 / 16 x 8 contacts
Size 20 x 21 contacts

Current Rating — Up to 35 Amps per size 12 contact

Contact Features — Hot-Plug size 12 contact option

Contact Sequencing — Multi-level for power and signal

Contact Terminations —
Size 12: Crimp and PCB tail
Size 16: Crimp and PCB tail
Size 20: Crimp and PCB tail

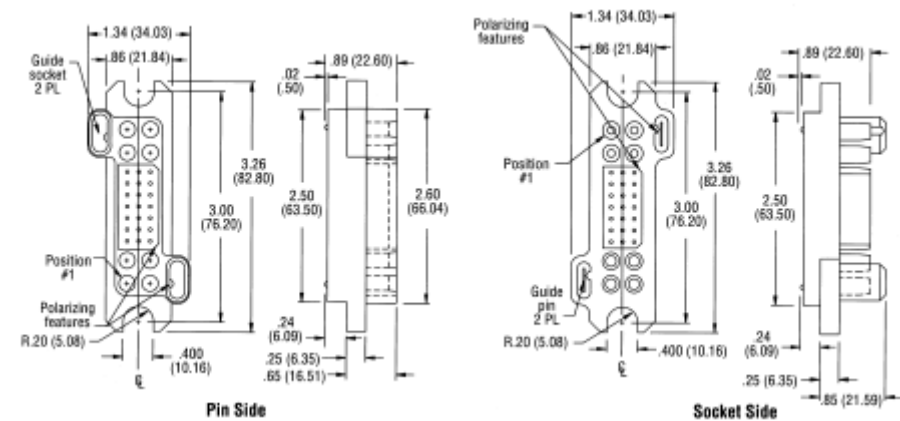

Base Housing Part Numbers

Pin Housing		Socket Housing	
1648203-1	Size 12 + Size 20 + Size 12	1648206-1	Size 12 + Size 20 + Size 12
1648204-1	Size 16 + Size 20 + Size 16	1648207-1	Size 16 + Size 20 + Size 16
1648205-1	Size 12 + Size 20 + Size 16	1648208-1	Size 12 + Size 20 + Size 16

Note: All part numbers are RoHS compliant.

ELCON Drawer Series Connectors (Continued)

75A Middle Drawer

- Dimensions** —
3.31" x 1.31" (84.1 x 33.3 mm)
- Housing Variations** — See Part Numbers
- Guides and Polarization** — Built in
- Available Contacts** —
Size 8 x 4 contacts
Size 12 x 9 contacts
Size 20 x 24 contacts
- Current Rating** — Up to 75 Amps per size 8 contact
- Contact Features** — Hot-Plug size 12 contact option
- Contact Sequencing** — Multi-level for power and signal
- Contact Terminations** —
Size 8: Crimp, internal/external thread and PCB tail
Size 12: Crimp and PCB tail
Size 20: Crimp and PCB tail

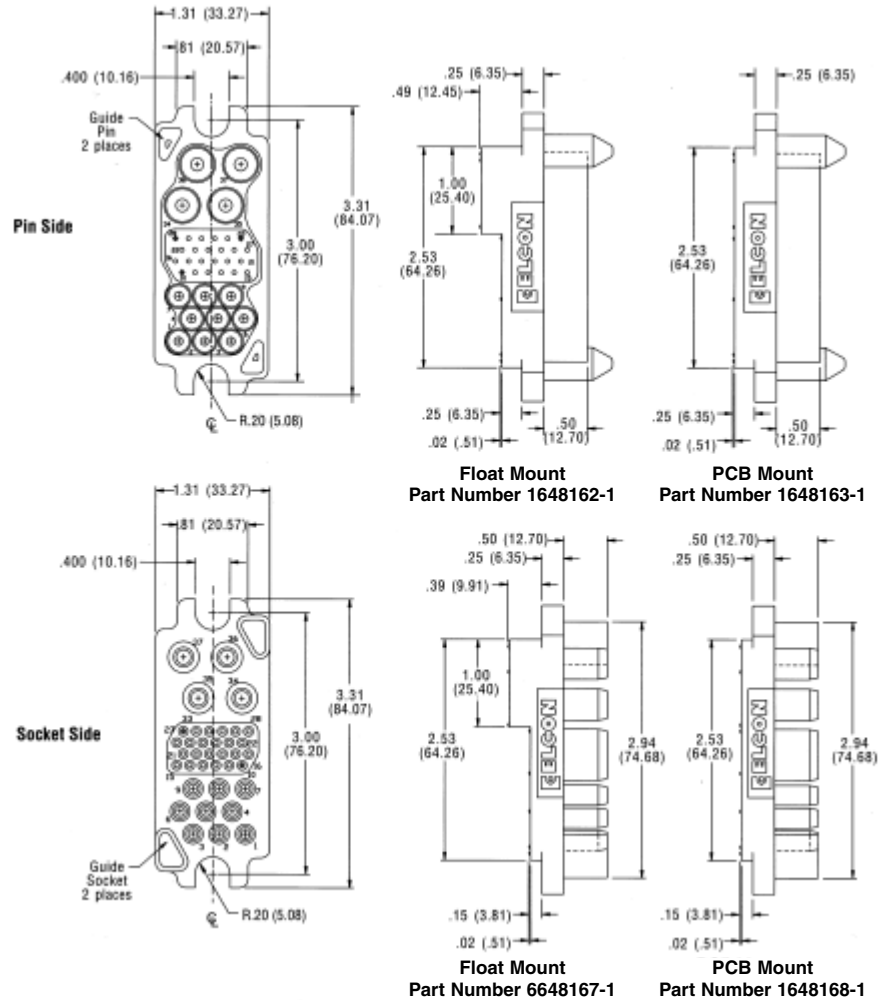

Base Housing Part Numbers

Pin Housing		Socket Housing	
1648162-1	Float Mount	6648167-1	Float Mount w/ reinforced housing
1648163-1	PCB Mount	1648168-1	PCB Mount

Note: All part numbers are RoHS compliant.

ELCON Drawer Series Connectors (Continued)

125A Middle Drawer

Dimensions —

3.15" x 1.31" (80.0 x 33.3 mm)

Housing Variations — See Part Numbers

Guides and Polarization — Built in

Available Contacts —

Size 4 x 2 contacts

Size 12 x 6 contacts

Size 20 x 32 contacts

Current Rating — Up to 125 Amps per size 4 contact

Contact Features — Hot-Plug size 12 contact option

Contact Sequencing — Multi-level for power and signal

Contact Terminations —

Size 4: Crimp and internal/external thread

Size 12: Crimp and PCB tail

Size 20: Crimp and PCB tail

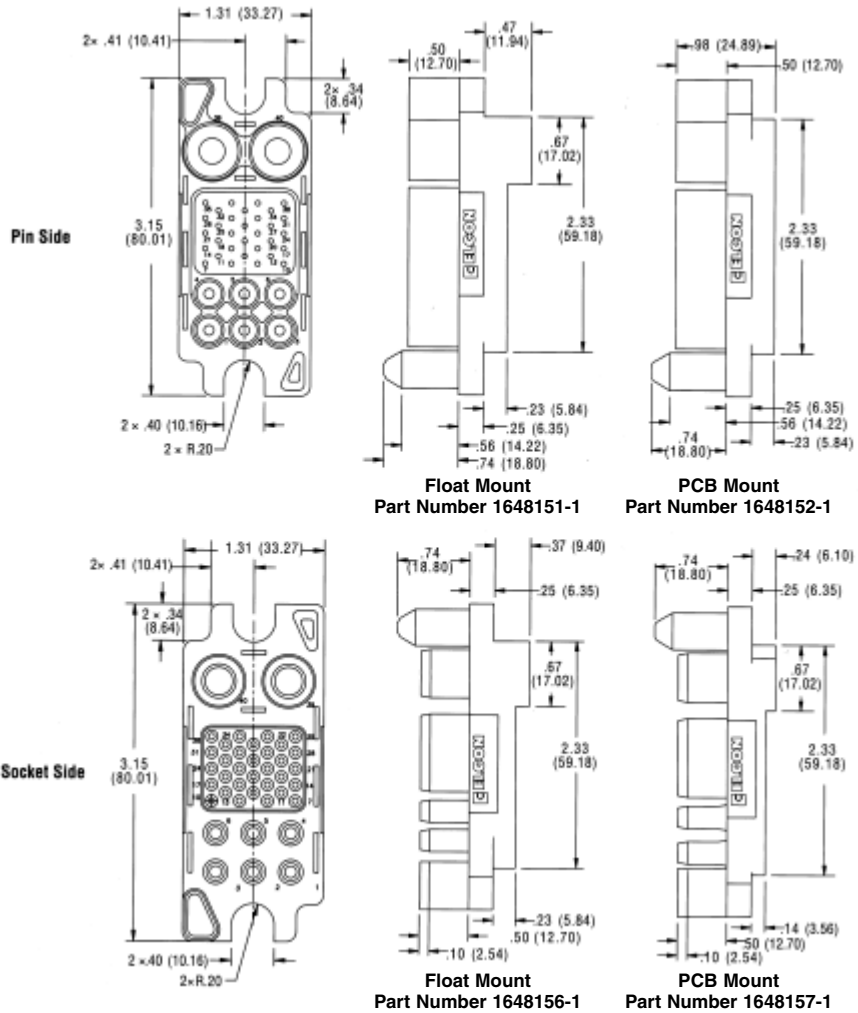

Base Housing Part Numbers

Pin Housing		Socket Housing	
1648151-1	Float Mount	1648156-1	Float Mount
1648152-1	PCB Mount	1648157-1	PCB Mount

Note: All part numbers are RoHS compliant.

ELCON Drawer Series Connectors (Continued)

200A Middle Drawer

Dimensions —

3.31" x 1.31" (84.1 x 33.3 mm)

Housing Variations — See Part Numbers

Guides and Polarization — Built in

Available Contacts —

Size 4 x 2 contacts

Size 8 x 6 contacts

Size 12 x 3 contacts

Size 20 x 14 contacts

Current Rating — Up to 125 Amps per size 4 contact

Contact Features — Hot-Plug size 12 contact option

Contact Sequencing — Multi-level for power and signal

Contact Terminations —

Size 4: Crimp and internal/external thread

Size 8: Crimp, internal/external thread and PCB tail

Size 12: Crimp and PCB tail

Size 20: Crimp and PCB tail

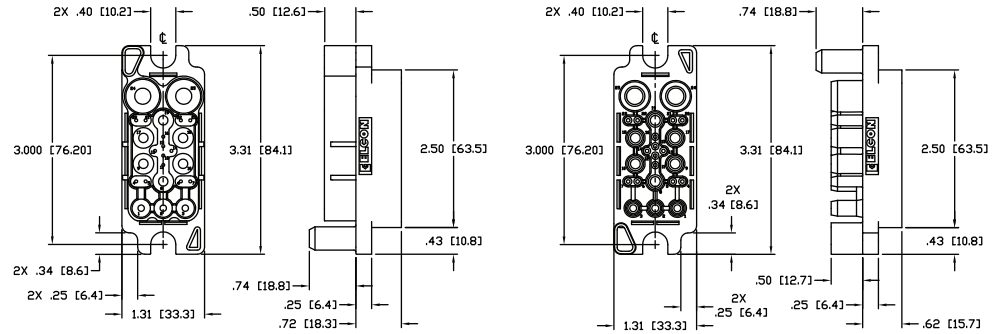

Base Housing Part Numbers

Pin Housing	Socket Housing
1648134-1	1648135-1

Square Drawer

Dimensions —

2.76" x 1.24" (70.1 x 31.5 mm)

Housing Variations — See Part Numbers

Guides and Polarization — Built in

Available Contacts —

Size 12 x 4 contacts

Size 20 x 36 contacts

Current Rating — Up to 35 Amps per size 12 contact

Contact Features — Hot-Plug size 12 contact option

Contact Sequencing — Multi-level for power and signal

Contact Terminations —

Size 12: Crimp and PCB tail

Size 20: Crimp and PCB tail

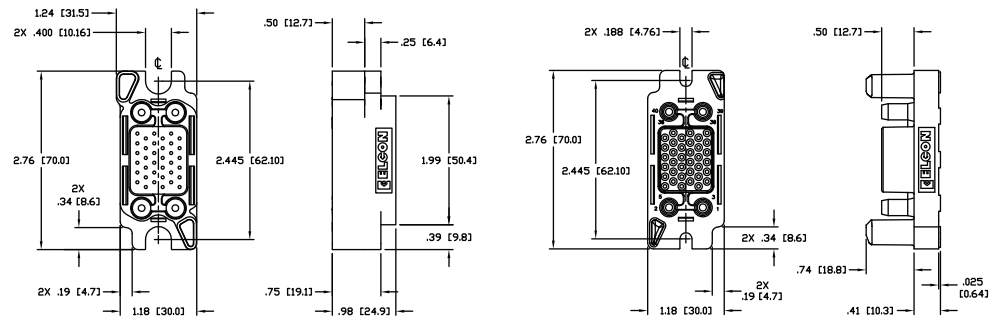

Base Housing Part Numbers

Pin Housing	Socket Housing
1648132-1	1648133-1

Note: All part numbers are RoHS compliant.

ELCON Drawer Series Connectors (Continued)

Top Drawer

Dimensions —
4.24" x 1.60" (107.8 x 40.7 mm)

Housing Variations — Various guide pin configurations available.

Guides and Polarization — Optional Steel Guide Pins with either #6-32 or M3 internal thread

Available Contacts —
Size 0 x 2 contacts
Size 12 x 6 contacts
Size 16 x 12 contacts
Size 20 x 32 contacts

Current Rating — Up to 200 Amps per size 0 contact

Contact Features — Hot-Plug size 12 contact option
Probe-proof size 0 contact option

Contact Sequencing — Multi-level for power and signal

Contact Terminations —
Size 0: Crimp and internal/external thread
Size 12: Crimp and PCB tail
Size 16: Crimp and PCB tail
Size 20: Crimp and PCB tail

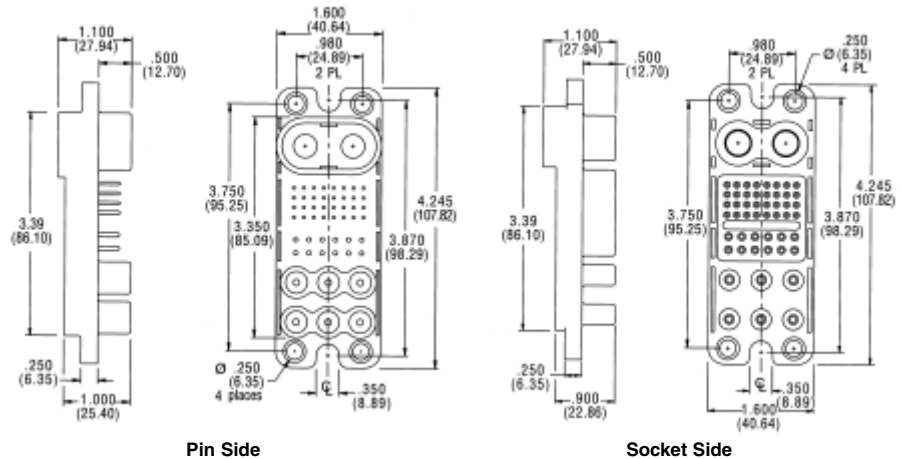

Pin Side

Socket Side

Base Housing Part Numbers

Pin Housing	Socket Housing
1648183-1	1648186-1

Optional guide posts are available for improved alignment. Consult Customer Service for details.

Double Drawer

Dimensions — 4.24" x 1.60" (107.8 x 40.7 mm)

Housing Variations — Various guide pin configurations available.

Guides and Polarization — Optional Steel Guide Pins with either #6-32 or M3 internal thread

Available Contacts —
Size 0 x 4 contacts
Size 12 x 11 contacts
Size 20 x 24 contacts

Current Rating — Up to 200 Amps per size 0 contact

Contact Features — Hot-Plug size 12 contact option
Probe-proof size 0 contact option

Contact Sequencing — Multi-level for power and signal

Contact Terminations —
Size 0: Crimp and internal/external thread
Size 12: Crimp and PCB tail
Size 20: Crimp and PCB tail

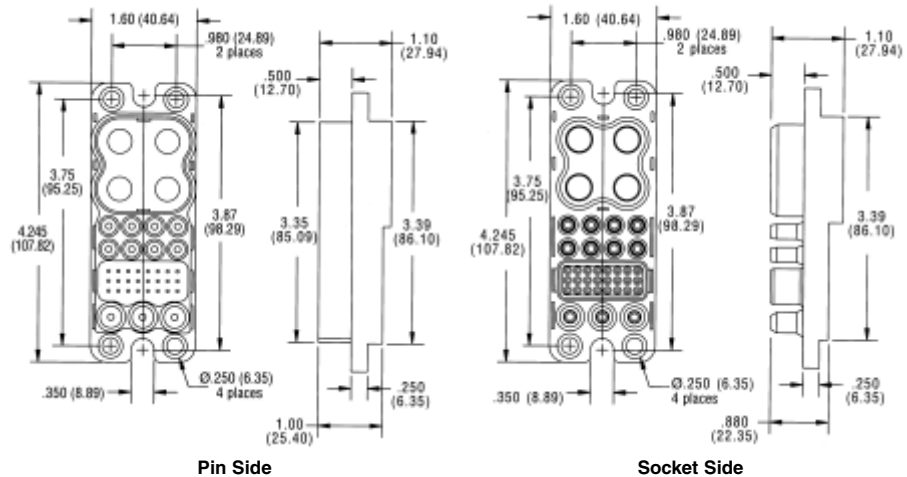

Pin Side

Socket Side

Base Housing Part Numbers

Pin Housing	Socket Housing
1648552-1	1648578-1

Optional guide posts are available for improved alignment. Consult Customer Service for details.

Note: All part numbers are RoHS compliant.

ELCON Drawer Series Connectors (Continued)

DualPower Drawer

Dimensions —

1.80" x 1.60" (45.7 x 40.7 mm)

Housing Variations — Various guide pin configurations available.

Guides and Polarization — Optional Steel Guide Pins with either #6-32 or M3 internal thread

Available Contacts — Size 0 x 2 contacts

Current Rating — Up to 200 Amps per contact

Contact Features — Probe-proof size 0 contact option

Contact Sequencing — Standard only

Contact Terminations — Size 0: Crimp and internal/external thread

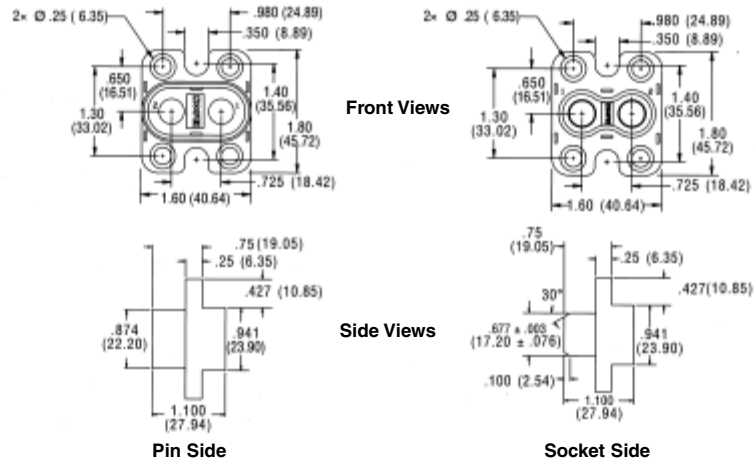

Base Housing Part Numbers

Pin Housing	Socket Housing
1648549-1	1648575-1

Optional guide posts are available for improved alignment. Consult Customer Service for details.

QuadPower Drawer

Dimensions —

2.50" x 1.60" (63.5 x 40.7 mm)

Housing Variations — Various guide pin configurations available.

Guides and Polarization — Optional Steel Guide Pins with either #6-32 or M3 internal thread

Available Contacts — Size 0 x 4 contacts

Current Rating — Up to 200 Amps per contact

Contact Features — Probe-proof size 0 contact option

Contact Sequencing — Standard only

Contact Terminations — Size 0: Crimp and internal/external thread

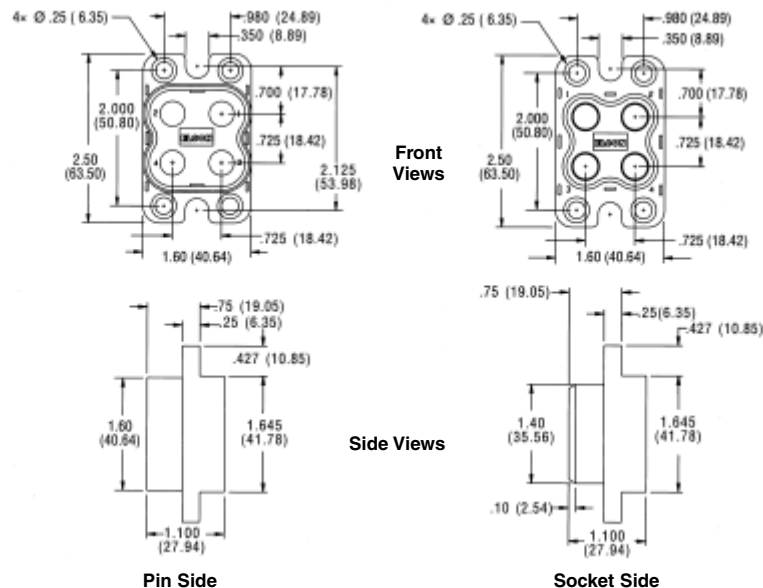

Base Housing Part Numbers

Pin Housing	Socket Housing
1648548-1	1648574-1

Optional guide posts are available for improved alignment. Consult Customer Service for details.

Note: All part numbers are RoHS compliant.

ELCON Drawer Series Connectors (Continued)

In-Line QuadPower Drawer

Dimensions —
4.84" x 1.21" (122.8 x 30.7 mm)
Housing Variations — See Part Numbers
Guides and Polarization — Built in
Available Contacts — Size 0 x 4 contacts
Current Rating — Up to 200 Amps per contact
Contact Features — Probe-proof size 0 contact option
Contact Sequencing — Standard only
Contact Terminations —
Size 0: Crimp and internal/external thread

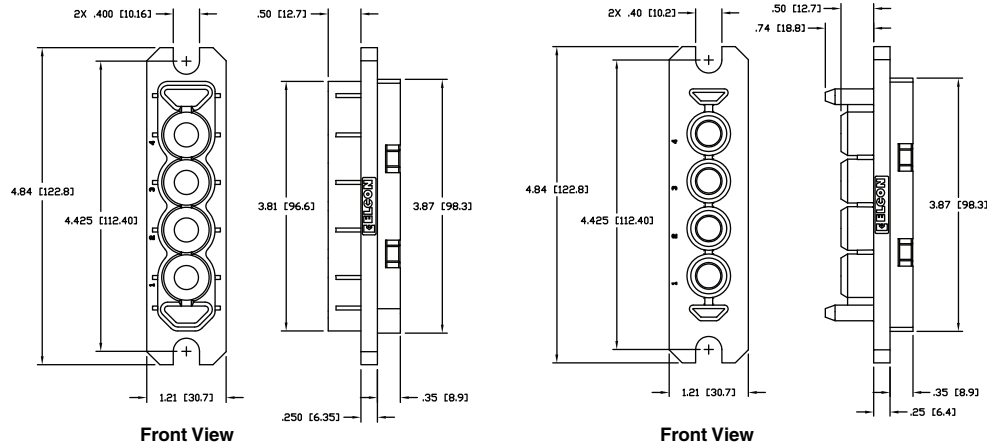

Base Housing Part Numbers

Pin Housing	Socket Housing
1651493-1	1651494-1

W5 Power Drawer

Dimensions —
3.00" x 1.18" (76.2 x 30.0 mm)
Housing Variations — See Part Numbers
Guides and Polarization — Built in
Available Contacts — Size 4 x 5 contacts
Current Rating — Up to 100 Amps per contact
Contact Features — Probe-proof size 0 contact option
Contact Sequencing — Standard only
Contact Terminations —
Size 4: Crimp and internal/external thread

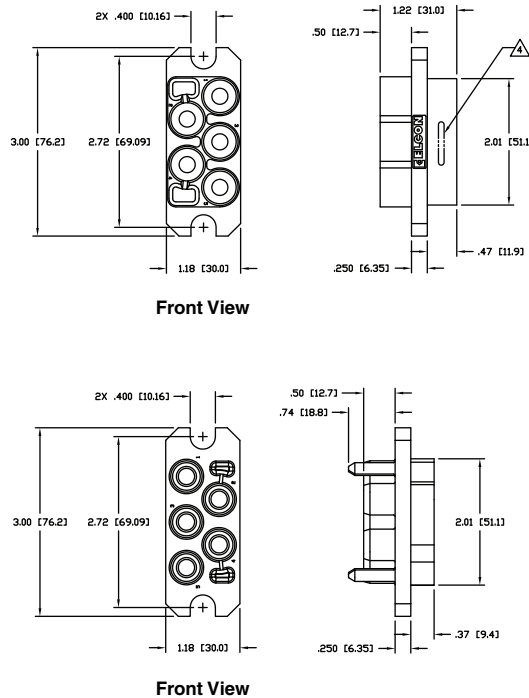

Base Housing Part Numbers

Pin Housing	Socket Housing
6651457-1	6651458-1

Note: All part numbers are RoHS compliant.

ELCON Drawer Series Connectors (Continued)

P3S0 Drawer

- Dimensions** — 0.99" x 0.95" (25.0 x 24.0 mm)
- Housing Variations** — See Part Numbers
- Cable Socket to Panel Mount Pin
- Guides and Polarization** — Polarization only
- Available Contacts** — Size 12 x 3 contacts
- Current Rating** — Up to 35 Amps per size 12 contact
- Contact Features** — Hot-Plug size 12 contact option
- Contact Sequencing** — Multi-level for power
- Contact Terminations** — Size 12: Crimp only

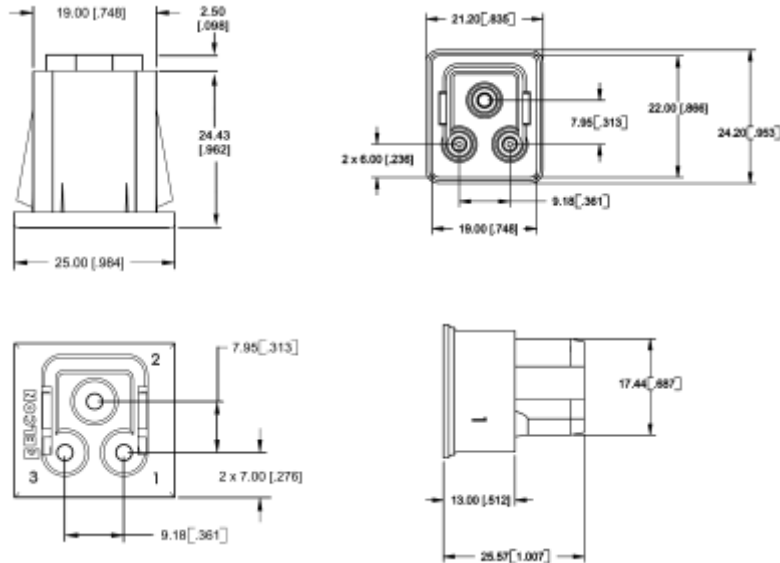

Base Housing Part Numbers

Pin Housing	Socket Housing
1766447-1	1766448-1

P4S0 Drawer

- Dimensions** — 1.34" x 0.76" (34.0 x 19.4 mm)
- Housing Variations** — See Part Numbers
- Cable Pin to PCB Mount Socket
- Guides and Polarization** — Polarization only
- Available Contacts** — Size 12 x 4 contacts
- Current Rating** — Up to 35 Amps per size 12 contact
- Contact Sequencing** — Standard only
- Contact Terminations** — Size 12: Crimp Pin and PCB tail Socket
- Note:** Supplied as kit, including contacts

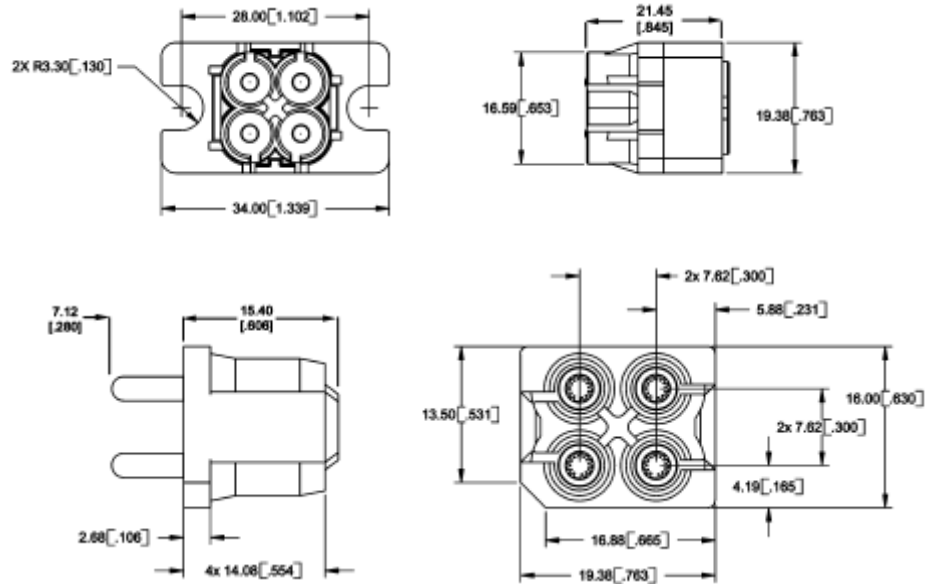

Base Housing Part Numbers

Pin Side Kit	Socket Side Kit
1766449-1	1766450-1

Note: All part numbers are RoHS compliant.

ELCON Drawer Series Connectors (Continued)

HV8P Drawer

- Dimensions** —
2.50" x 1.11" (63.5 x 28.2 mm)
- Housing Variations** — See Part Numbers
- 600 V High Voltage Design
- Guides and Polarization** — Built in
- Available Contacts** — Size 12 x 8 contacts
- Current Rating** — Up to 35 Amps per size 12 contact
- Contact Features** — Hot-Plug size 12 contact option
- Contact Sequencing** — Multi-level for power
- Contact Terminations** —
Size 12: Crimp and PCB tail

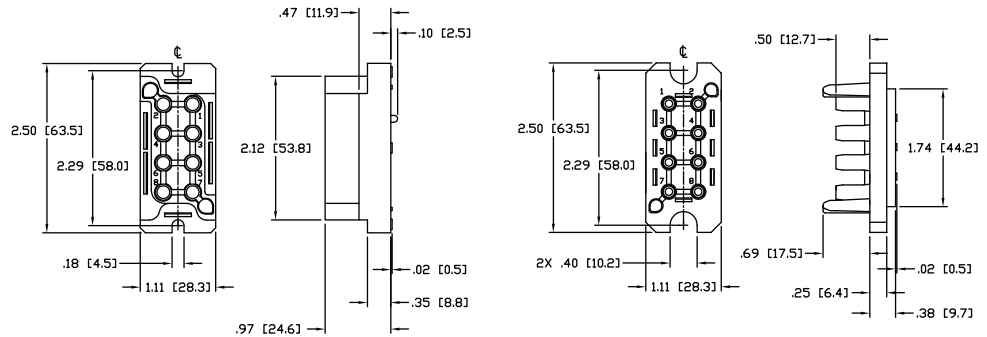

Base Housing Part Numbers

Pin Housing	Socket Housing
1648127-1	1648128-1

P10S0 Drawer

- Dimensions** —
2.96" x 1.00" (75.0 x 25.4 mm)
- Housing Variations** — See Part Numbers
- Guides and Polarization** — Built in
- Available Contacts** — Size 12 x 10 contacts
- Current Rating** — Up to 35 Amps per size 12 contact
- Contact Features** — Hot-Plug size 12 contact option
- Contact Sequencing** — Multi-level for power
- Contact Terminations** —
Size 12: Crimp and PCB tail

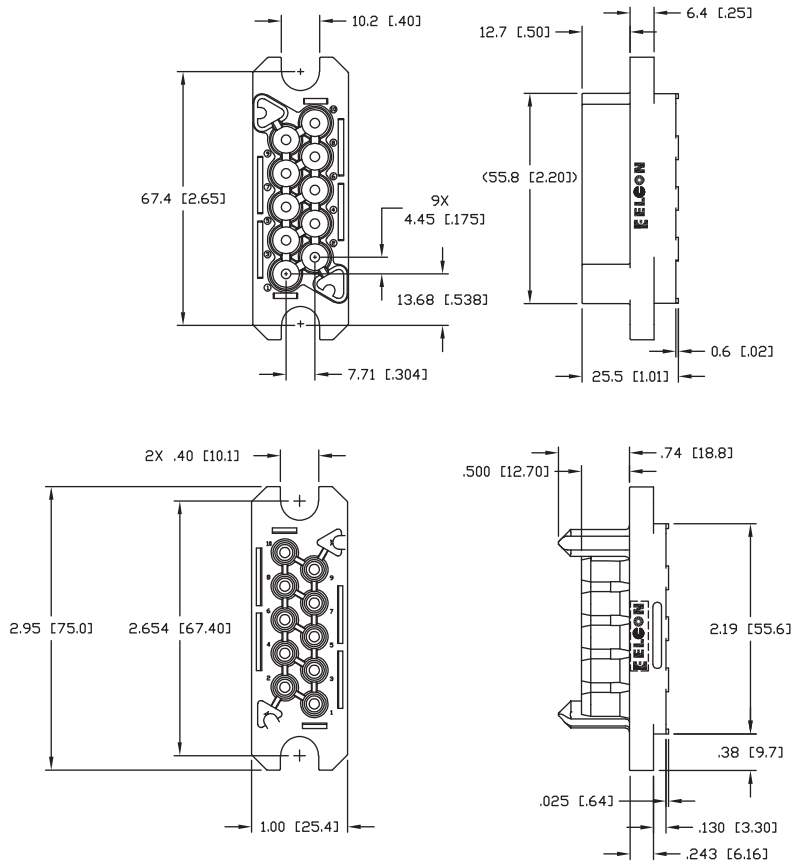

Base Housing Part Numbers

Pin Housing	Socket Housing
1648568-1	1648596-1

Note: All part numbers are RoHS compliant.

ELCON Drawer Series Connectors (Continued)

P6S18 Drawer

- Dimensions** —
5.45" x 1.35" (138.4 x 34.3 mm)
- Housing Variations** — See Part Numbers
- Guides and Polarization** — Built in
- Available Contacts** —
Size 4 x 6 contacts
Size 20 x 18 contacts
- Current Rating** — Up to 100 Amps per size 4 contact
- Contact Features** — Standard
- Contact Sequencing** — Multi-level for power and signal
- Contact Terminations** —
Size 4: Crimp and internal/external thread
Size 20: Crimp and PCB tail

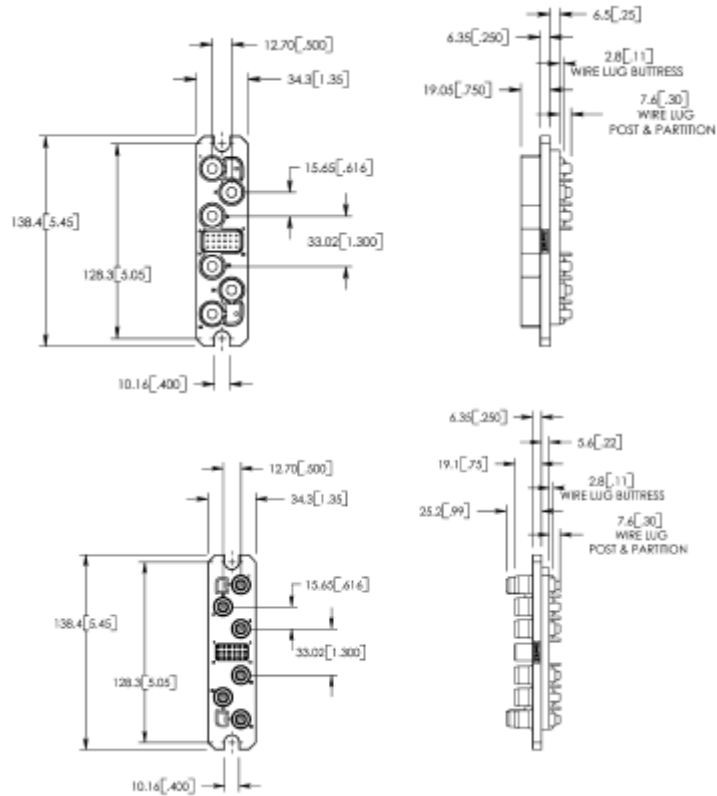

Base Housing Part Numbers

Pin Housing	Socket Housing
1766451-1	1766452-1

P10S22 Drawer

- Dimensions** —
4.12" x 0.79" (104.5 x 20.1 mm)
- Housing Variations** — See Part Numbers
- Guides and Polarization** — Built in
- Available Contacts** —
Size 12 x 10 contacts
Size 20 x 22 contacts
- Current Rating** — Up to 35 Amps per size 12 contact
- Contact Features** — Hot-Plug size 12 contact option
- Contact Sequencing** — Multi-level for power and signal
- Contact Terminations** —
Size 12: Crimp and PCB tail
Size 20: Crimp and PCB tail

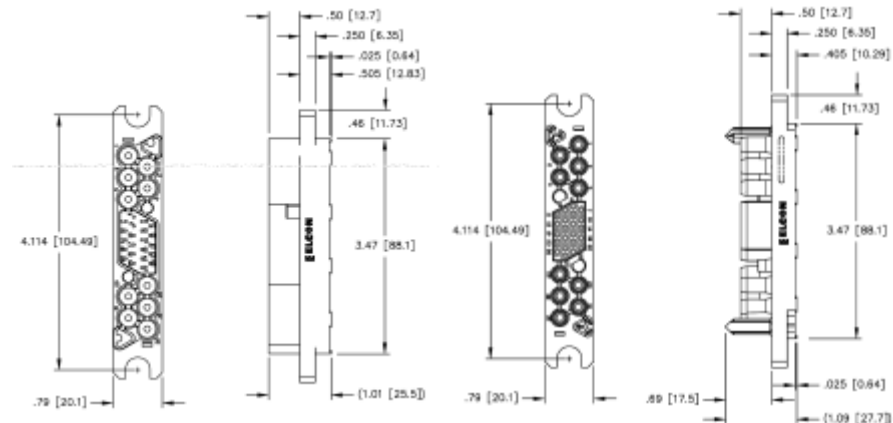

Base Housing Part Numbers

Pin Housing	Socket Housing
6648211-1	6648212-1

Note: All part numbers are RoHS compliant.

ELCON Drawer Series Connectors (Continued)

- Dimensions** —
4.31" x 0.70" (109.5 x 17.8 mm)
- Housing Variations** — See Part Numbers
- Guides and Polarization** — Built in
- Available Contacts** —
Size 16 x 12 contacts
Size 20 x 12 contacts
- Current Rating** — Up to 15 Amps per size 16 contact
- Contact Features** — Standard only
- Contact Sequencing** — Multi-level for power and signal
- Contact Terminations** —
Size 16: Crimp and PCB tail
Size 20: Crimp and PCB tail

P12S12 Drawer

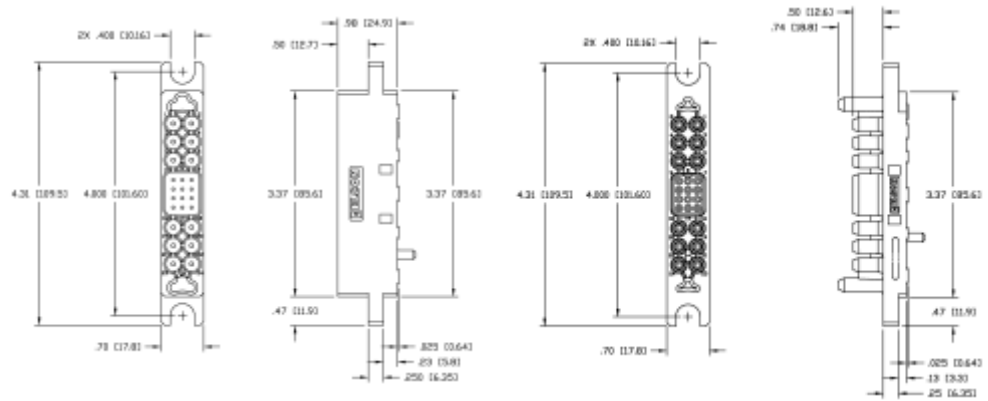

Base Housing Part Numbers

Pin Housing	Socket Housing
6651202-1	6651203-1

POS30 Drawer

- Dimensions** —
3.22" x 0.70" (81.8 x 17.8 mm)
- Housing Variations** — See Part Numbers
- Guides and Polarization** — Built in
- Available Contacts** — Size 20 x 30 contacts
- Current Rating** — Up to 5 Amps per size 20 contact
- Contact Features** — Standard only
- Contact Sequencing** — Multi-level for signal
- Contact Terminations** —
Size 20: Crimp and PCB tail

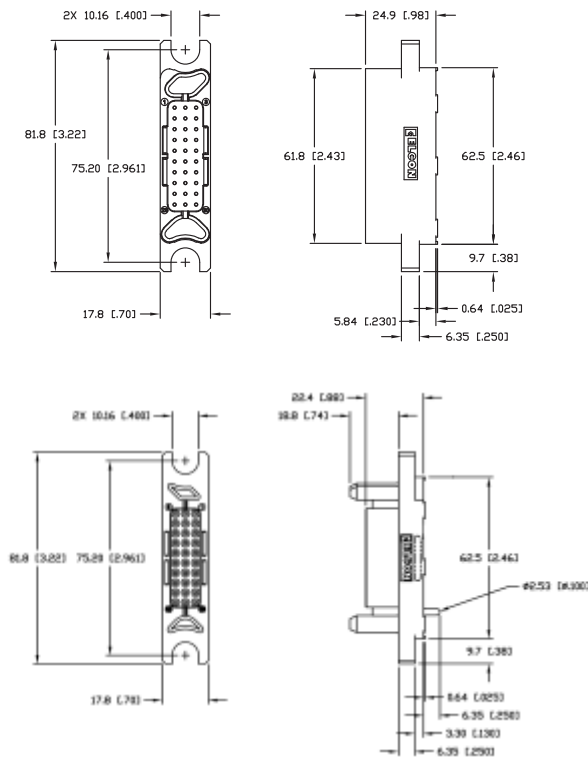

Base Housing Part Numbers

Pin Housing	Socket Housing
6651204-1	6651205-1



Note: All part numbers are RoHS compliant.

The ELCON Drawer Series Connectors use standard contacts across the product line. This section shows the standard contacts available in different sizes and various lengths and termination styles, with their respective part numbers.



ELCON Drawer Standard Contacts

Pin Side Contacts



Contact Size #20 — For use in most drawer connectors

Termination Type	Contact Part Number	Dimensions	A	
			in	mm
Crimp, standard	1650155-1		0.32	[8.12]
Crimp, premate	1650161-1		0.47	[11.93]
Crimp, postmate	1650162-2		0.27	[6.85]
PCB tail, standard	1650283-1		0.32	[8.12]
PCB tail, premate	1650065-1		0.47	[11.93]
PCB tail, postmate	1650226-1		0.27	[6.85]

Contact Size #16 — For use in Mini Drawer, Lower Drawer, Top Drawer, and P12S12



Termination Type	Contact Part Number	Dimensions	A	
			in	mm
Crimp, standard	1766194-1		0.33	[8.38]
Crimp, premate	1766198-1		0.48	[12.19]
Crimp, postmate	1766199-1		0.29	[7.36]
PCB tail, standard	1766222-1		0.33	[8.38]
PCB tail, premate	1766223-1		0.48	[12.19]
PCB tail, postmate	1766818-1		0.29	[7.36]

Contact Size #12 — For use in Mini Drawer, Lower Drawer, 75A, 125A and 200A Middle Drawer; Square Drawer, TOP Drawer & Double Drawer; P3S0 and P4S0, HV8P, P10S0, P10S22



Termination Type	Contact Part Number		Dimensions	A	
	Gold Plated	Silver Plated		in	mm
Crimp, standard	1650153-2	1766193-1		0.43	[10.92]
Crimp, premate	1650156-2	1766195-1		0.46	[11.68]
Crimp, postmate	1650158-2	1766196-1		0.39	[9.90]
PCB tail, standard	—	1766245-1		0.43	[10.92]
PCB tail, premate	1650074-3	1766250-1		0.46	[11.68]
PCB tail, postmate	1658992-4	1766249-1		0.39	[9.90]

Note: For applications using the #12 hot-plug socket use of gold plated pins are recommended.

Contact Size #8 - For use in 75A and 200 A Middle Drawer

Termination Type	Contact Part Number	Dimensions	A	
			in	mm
Crimp, standard	1766192-1		0.43	[10.92]
Crimp, premate	1766197-1		0.48	[12.19]
PCB tail, standard	1766262-1		0.43	[10.92]
PCB tail, premate	1766263-1		0.48	[12.19]

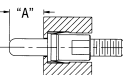
Contact Size #4 - For use in 125A and 200A Middle Drawer. P6S18 Drawer, W5 Power Drawer





Termination Type	Contact Part Number	Dimensions	A	
			in	mm
Crimp, Standard	1766232-1		0.51	[12.95]
1/4 - 20 x .050 DP External Thread	11766812-1		0.51	[12.95]
M5 x 0.8 x 9.6 mm DP M5 Internal Thread	1766283-1		0.51	[12.95]

Note: All part numbers are RoHS compliant.

ELCON Drawer Standard Contacts (Continued)

Pin Side Contacts (Continued)

Contact Size #01 - For use in Top Drawer, Double Drawer, DualPower & QuadPower, In-Line QuadPower

Termination Type	Contact Part Number	Dimensions	A	
			in	mm
Crimp	1766811-1		0.495	[12.57]
Probe-proof crimp ²	1766819-1		0.430	[10.92]
1/4 - 20 x .050 DP Internal thread	1766230-1		0.495	[12.57]
M6 x 1 x 12.7 mm DP Internal thread	1766274-1		0.495	[12.57]
1/4 - 20 x .050 DP Probe-proof/internal thread ²	1766269-1		0.430	[10.92]
M6 x 1 x 12.7 mm DP Probe-proof/Internal thread ²	1766275-1		0.430	[10.92]
1/4 - 20 x .050 DP External thread	1766268-1		0.495	[12.57]
M6 x 1 x 12.7 mm DP External thread	1766231-1		0.495	[12.57]
1/4 - 20 x .050 DP Probe-proof/external thread ²	1766270-1		0.430	[10.92]
M6 x 1 x 12.7 mm DP Probe-proof/external thread ²	1766276-1		0.430	[10.92]

Notes: ¹Contact Tyco Electronics for alternate contact terminations.
²Use only with probe-proof socket contacts.
³Crimp and threaded contact are insertable/removable.

Socket Side Contacts

Contact Size #20

Termination Type	Contact Part Number
Crimp	1648325-1
PCB Tail	1648382-1

Contact Size #16

Termination Type	Contact Part Number
Crimp	6648319-1
PCB Tail	6648383-1

Contact Size #12

Termination Type	Contact Part Number
Crimp	6648318-1
Hot-Plug Crimp	1648384-1
PCB Tail	6648374-1
Hot-Plug PCB Tail	1648387-1

Note: For applications using the #12 hot-plug socket, the use of gold plated pins are recommended (see page 79).

Note: All part numbers are RoHS compliant.

ELCON Drawer Standard Contacts (Continued)

Socket Side Contacts
Contact Size #8

Termination Type	Contact Part Number
Crimp	6648317-1
PCB Tail	6648400-1

Contact Size #4

Termination Type	Contact Part Number
Crimp, Standard	6648434-1
1/4 - 20 x .050 DP External Thread	6648435-1
M5 x 0.8 x 9.6 mm DP M5 Internal Thread	6648335-1

Contact Size #0¹

Termination Type	Contact Part Number
Crimp	6648405-1
Probe-proof crimp ²	6648418-1
1/4 - 20 x .050 DP Internal thread	6648416-1
M6 x 1 x 12.7 mm DP Internal thread	6648428-1
1/4 - 20 x .050 DP Probe-proof/internal thread ²	6648419-1
M6 x 1 x 12.7 mm DP Probe-proof/Internal thread ²	6648429-1
1/4 - 20 x .050 DP External thread	6648417-1
M6 x 1 x 12.7 mm DP External thread	6648430-1
1/4 - 20 x .050 DP Probe-proof/external thread ²	6648420-1
M6 x 1 x 12.7 mm DP Probe-proof/external thread ²	6648431-1

Notes: ¹Contact Tyco Electronics for alternate contact terminations.

²Use only with probe-proof Pin contacts.

³Crimp and threaded contact are insertable/removable.

Non-Standard Contacts

Contacts with pin lengths and terminations other than standard are available.

Consult customer service if your design requires contacts different from the ones shown in this catalog.

Note: All part numbers are RoHS compliant.

AMP Drawer Series Connectors — Miniature Power Drawer (MPD) Connectors

Product Facts

- High mating cycle life
- Low Mating and Un-mating force (< 0.2lbs per contact)
- Single-piece molded housing
- Molded-in guide pins provide generous blind-mateability
- Sizes: 3 – 10 positions
- Compact size is ideal for distributed DC power applications
- Two Levels of contact sequencing
- One contact for either solder or press-fit termination
- Hardware — Less or traditional shoulder bolt mounting
- Minimum of 3mm contact wipe on shortest power contact
- All MPD connectors in this section are RoHS compliant

Specifications

Up to 15 amps per contact
 250 mating cycle durability
 +/- 1.25mm radial mis-alignment capability. (Total float is 2.5mm!)

1.6mm sequencing distance — ideal for modular sheet metal construction applications

Minimum of 3mm contact wipe on shortest power contact

Maximum continuous operating temperature — 105°C

UL 94 V-0 High-temperature thermoplastic housings

Technical Documents

Product Specification

108-1998

Application Specification

114-13067

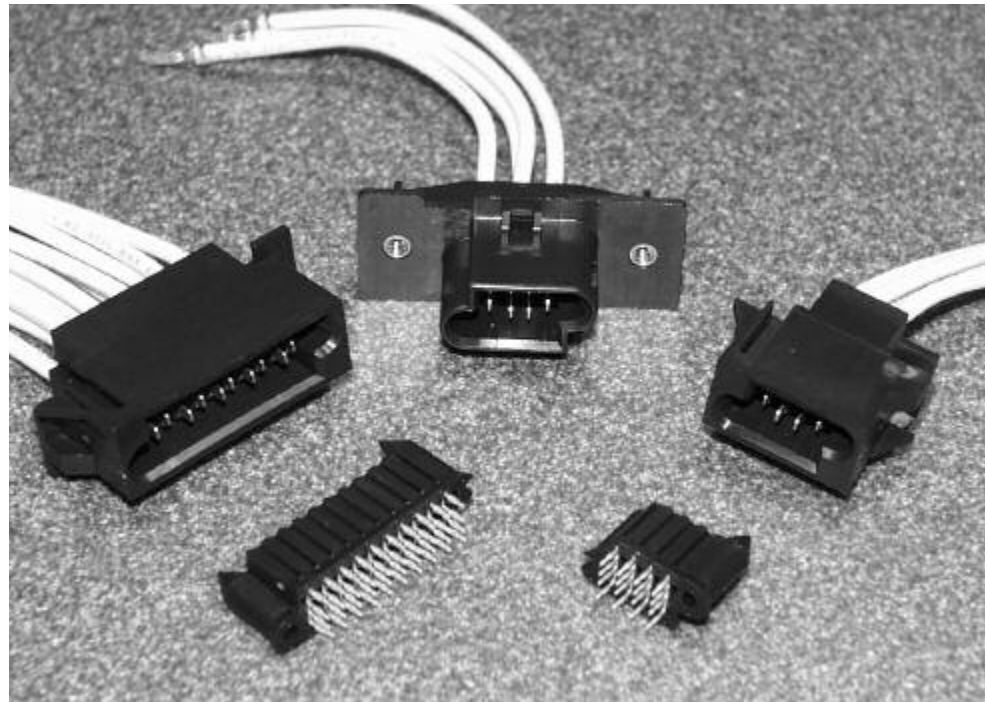

The new Miniature Power Drawer connector combines a high density power interface in a blind-mateable wire-to-board connector. The MPD contact interface has been previously qualified to requirements similar to BellCore GR-1217 in board-to-board applications. Now available in a crimp-to-wire version, the contacts are rated for up to 15 Amps on 14 AWG wire. In addition, the MPD contacts are designed to meet UL 1977 Hot-Plug requirements for up to 7.8 Amps at 48VDC.

The connection consists of a vertical pcb mountable receptacle and a panel mounted floating plug. The vertical receptacle pcb tails are designed for use in either through-hole solder or press-fit applications. The float-mount plug is easily installed from the inside of the chassis without any additional hardware, lending itself to easy assembly of pre-made cable assemblies. Additionally, the staggered wire exit pattern permits the maximum number of contact interfaces in the least amount of connector volume.

The compact design is ideal for bringing power to small rack-mounted devices such as 1U Computer Servers and Telecommunications Switches. The 3mm center-line satisfies UL 1977 safety requirements for 48 VDC distributed power applications. For higher voltage applications such as AC input, the contacts can be selectively loaded to handle up to 300 V AC or DC.

**AMP Drawer Series Connectors —
Miniature Power Drawer (MPD) Connectors** (Continued)

Crimp Contacts

Current Ratings

Standard Power — 10 Amps

High Power — 16 Amps

Material and Finish

Standard Power:

Crimp Blade Contacts — Brass

Receptacle Contacts —
Phos. Bronze.

Finish — 0.38µm Gold over 1.27µm Nickel

High Power:

Blades — High Conductivity Cu Alloy

Receptacle — High Conductivity Cu Alloy

Finish — 1.27µm Gold over 1.27µm Nickel

Contact Mating Length (Min.) —

Type A — 4.6mm

Type B — 3.0mm

Hot-Pluggability (With High Current Contacts only) —

250 Cycles — 7.8 Amps @ 48VDC

Note: All contacts are Sn plated in the crimp barrel or Sn in pcb interface

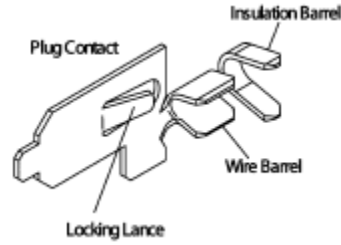

Crimp Blade Contacts

Wire Size	Type	Cycles	Mating Length	Part Number Strip / Loose Piece
18-20 AWG	Standard Power	100	A	1489128-8 / 1-1489128-4
			B	1489128-7 / 1-1489128-3
	High Power	250	A	1-1489128-0 / 1-1489128-6
			B	1489128-9 / 1-1489128-5
14-16 AWG	Standard Power	100	A	1489757-2 / 1-1489757-0
			B	1489757-1 / 1489757-9
	High Power	250	A	1489757-6 / 1-1489757-2
			B	1489757-5 / 1-1489757-1

Heavy Duty Miniature (HDM) Applicator for AMP-O-LECTRIC Model G Machine - #1385248-3.
PRO-CRIMPER Hand Tool #354940-1, Die set # 91363-2

Plugs and Receptacles

Materials

UL 94V-0 Thermoplastic

105°C Max. Operating temperature

Note: Vertical PCB Mt. Receptacles supplied with press-fit ACTION PIN contacts.

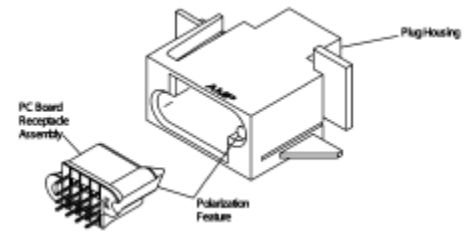
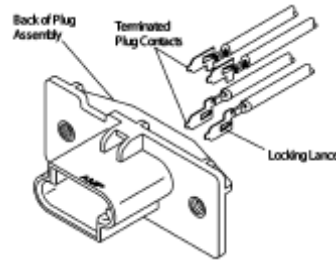

Number of Positions	Part Number			
	Panel Mt. Plug		PCB Mt. Receptacles	
	Snap-In	Shoulder Bolt	Standard Power	High Current
3	1489127-1	—	1489715-1	1-1489715-1
4	1489127-2	1489701-1	1489715-2	1-1489715-2
5	1489127-3	—	1489715-3	1-1489715-3
6	1489127-4	—	1489715-4	1-1489715-4
7	1489127-5	—	1489715-5	1-1489715-5
8	1489127-6	—	1489715-6	1-1489715-6
9	1489127-7	—	1489715-7	1-1489715-7
10	1489127-8	—	1489715-8	1-1489715-8

Note: All part numbers are RoHS compliant.

AMP Drawer Series Connectors — Hybrid Blindmate Drawer Connectors

Product Facts

- High current circuits and signal circuits can be mixed in the same connector
- High current circuits use MIC connector contacts located at four corners of the housing
- Signal circuits use Standard Drawer Connector contacts
- 24 positions
- Hermaphroditic housing can be mated with top and bottom turned while maintaining polarity

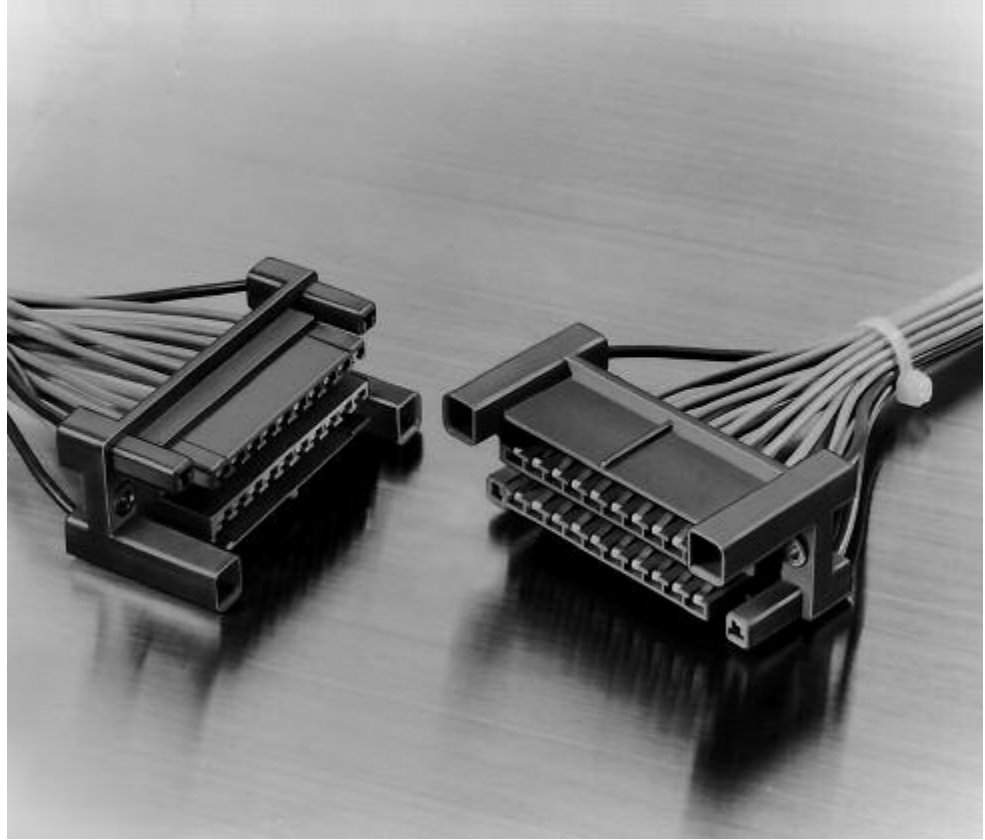

AMP Hybrid Drawer Connectors offer high current and signal circuits mixed in the same connector system.

High current circuits use MIC connector contacts which are located at the four corners of the housing.

Signal circuits use the same hermaphroditic crimp snap-in contacts that are used in the Standard Drawer Connector.

The hermaphroditic housings are available in a popular 24-position size. These housings can be mated with top and bottom turned while maintaining polarity.

Performance Specifications

Voltage Rating — 250 VAC

Current Rating (Max.) —

Signal Circuit (Drawer);
4 amperes — 24 AWG [0.2mm²] Wire
5 amperes — 22 AWG [0.3-0.4mm²] Wire
7 amperes — 20 AWG [0.5-0.6mm²] Wire
Power Circuit (MIC);
10 amperes

Low Level Resistance —

Signal Circuit (Drawer);
10 milliohms max. (Initial)
20 milliohms max. (Final)

Power Circuit (MIC);
3 milliohms (Initial)
6 milliohms (Final)

Dielectric Withstanding Voltage —

5000 milliohms (Initial)
2000 milliohms (Final)

Operating Temperature —

-20°C to +120°C

AMP Drawer Series Connectors —
Hybrid Blindmate Drawer Connectors (Continued)

Housings
(Hermaphroditic),
24 Positions

Material

Housing — Glass-filled polybutylene terephthalate (PBT), blue

Bushing — Brass, zinc-plated

Related Product Data

Performance Specifications — page 84

MIC Contacts — page 86

Crimp Snap-In Contacts — page 86

Technical Documents

AMP Product Specification
108-5371

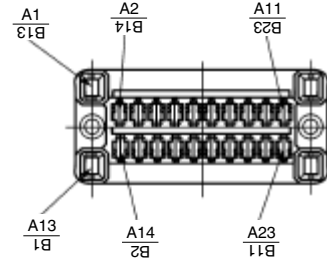
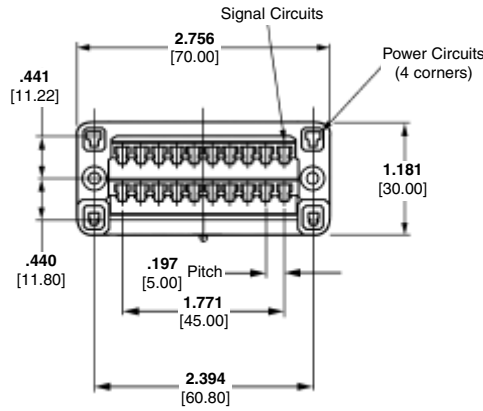

Note: Reverse figures show circuit numbers.

(Example = $\frac{A1}{13}$ The hole used for No. 1 circuit is used for No. 13 on the reverse side.)

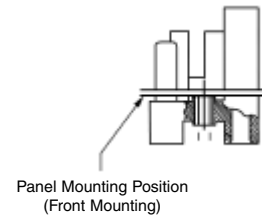
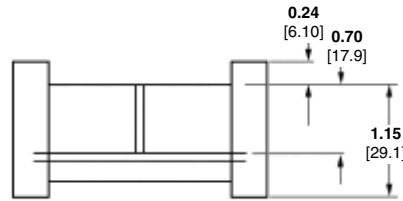

Floating of Bushing	Housing Part Numbers
Up- and downward = 0.05 [.002] Circumferential = 0.14 [.006]	176916-1
Up- and downward = 0.30 [.012] Circumferential = 0.80 [.031]	176916-2

Upward and downward = Axial clearance
Circumferential = Floating

Recommended Panel Cutout

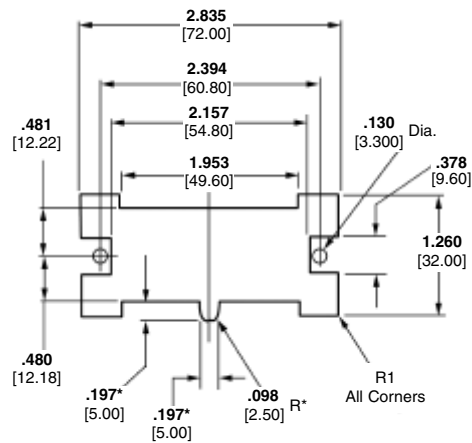

*Dimensions applicable for rear mounting.

Note: All part numbers are RoHS compliant.

**AMP Drawer Series Connectors —
Hybrid Blindmate Drawer Connectors** (Continued)

**MIC Contacts
(Used for Power Circuits)**

Material and Finish

Phosphor bronze, plated .000030 [0.00076] gold in contact area, remainder of contact gold flash, with entire contact underplated nickel

Related Product Data

Performance Specifications—
page 84

Housings—page 85

Technical Documents

AMP Instruction Sheets
408-089J, 408-369J, 408-370J

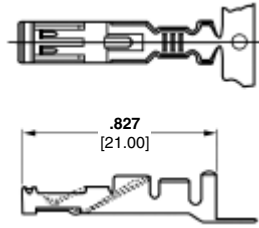

Wire Size Range		Insulation Diameter	Part Numbers		Hand Tool
AWG	mm ²		Receptacle Contact		
			Strip Form	Loose Piece	
20-14	0.5-2.0	.087-.134 2.20-3.40	170286-4	170289-3	755338-1* 755339-1

*Part Number 755338-1 is used on wire for automotive application; Part Number 755339-1 is used on other types of wire.

Extraction Tool Part Number 723735-1

**Crimp Snap-In Contacts
(Hermaphroditic, Used for
Signal Circuits)**

Material and Finish

Phosphor bronze, plated gold in contact area (for length of .236 [6.0] from tip), with entire contact underplated nickel

Related Product Data

Performance Specifications—
page 84

Housings—page 85

Technical Documents

AMP Instruction Sheets
408-097J, 408-151J

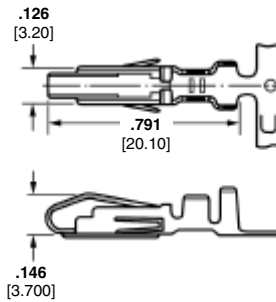

Wire Size Range		Insulation Dia. Range	Part Numbers		Applicator for AMP-O-ELECTRIC Machine*	Hand Tool
AWG	mm ²		Contact			
			Strip Form	Loose Piece		
24-20	0.2-0.6	.060-.077 1.50-1.95	170311-1	170313-1	567324-2	724632-1
20-16	0.5-1.4	.071-.130 1.80-3.30	170484-1	170485-1	567241-2	724787-1

*Applicators are for Model "K" machines. Consult AMP for applicators for other bench machines and lead-making machines.

Notes: For applicable wire, use wire specified in UL 1015 or 1007.

Extraction Tool Part Number 723986-1

Tab Contacts

Material and Finish

Brass, plated .000030 [0.00076] gold in contact area, with entire contact underplated nickel

Related Product Data

Performance Specifications—
page 84

Housings—page 85

Technical Documents

AMP Instruction Sheets
408-144J, 408-369J, 408-370J

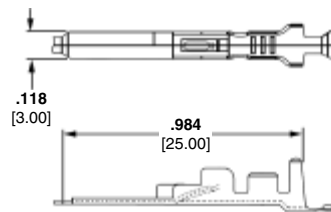

Wire Size Range		Insulation Diameter	Part Numbers		Hand Tool
AWG	mm ²		Tab Contact		
			Strip Form	Loose Piece	
20-14	0.5-2.0	.087-.134 2.20-3.40	170221-4	170222-3	755338-1* 755339-1

*Part Number 755338-1 is used on wire for automotive application; Part Number 755339-1 is used on other types of wire.

Extraction Tool Part Number 724763-1

Note: All part numbers are RoHS compliant.

**AMP Drawer Series Connectors —
Special Blindmate Drawer Connectors (uses AMP-LEAF Contacts)**

Product Facts

- Blindmate connectors accept AMP-LEAF crimp snap-in and solder dip contacts
- Contacts are phosphor bronze, gold-over-nickel plated
- 6 and 10 positions
- Housings made of polybutylene terephthalate (PBT)



Special Blindmate Drawer Connectors are available in 6- and 10-position configurations and provide wire-to-board and wire-to-wire connection capabilities. These connectors offer the integrity of AMP-LEAF contacts with maximum travel wiping action.

Housings feature molded-in guide pins and diagonally aligned sockets for correct polarization and to facilitate blindmating. The PC header guide pins extend through the PC board to secure the header to the board prior to soldering.

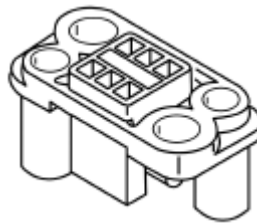

6-Position Socket Housing
(Accepts AMP-LEAF Crimp Snap-In Contacts)

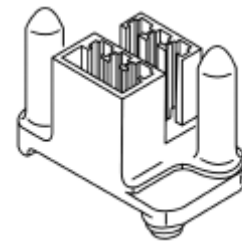

6-Position PC Board Header Housing
(Fully loaded with AMP-LEAF Solder Dip Contacts)

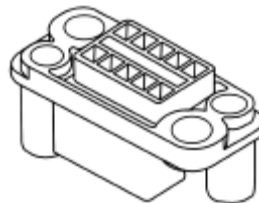

10-Position Socket Housing
(Accepts AMP-LEAF Crimp Snap-In Contacts)

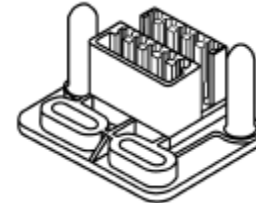

10-Position Header Housing
(Accepts AMP-LEAF Crimp Snap-In and Solder Dip Contacts)

Performance Specifications

Current Rating —
4 amperes (max.) — 26-22 AWG
[0.12-0.4mm²] wire

Voltage Rating — 50 VDC

Temperature Rating —
-10°C to +80°C

**Mounting Screw
(2 Required per Socket
Housing)**

Part Number 343404-1

Material and Finish

Steel, plated bright zinc chromate

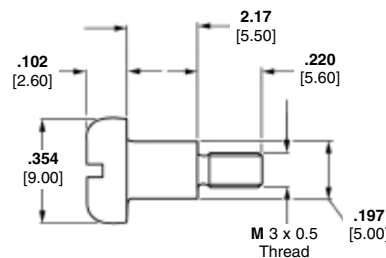

**AMP Drawer Series Connectors —
Special Blindmate Drawer Connectors** (Continued)

Cable Mounted Products

**Socket Housing,
6 Positions**

Part Number 343886-1

Accepts the following AMP-LEAF
Crimp Snap-In Contacts:
Part Number 583990-3 (loose piece)
Part Number 583204-2 (strip form)
Contacts must be ordered
separately.

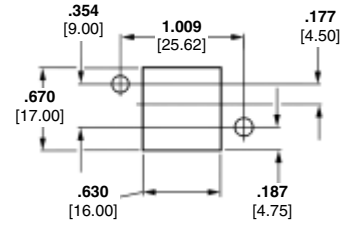
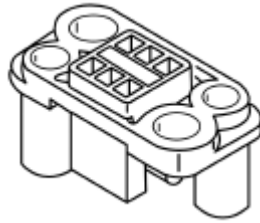

Recommended Panel Cutout

Material

Glass-filled polybutylene terephthalate
(PBT), black

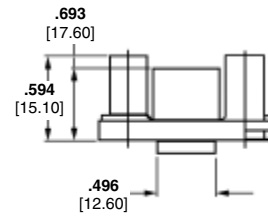
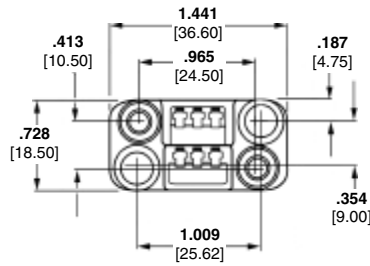

**PC Board Header Housing,
6 Positions with Board
Retention**

Part Number 343887-1

Accepts AMP-LEAF Crimp Snap-In
Contact Part Number 343371-1
and Solder Dip Contact
Part Number 583294-2

Contacts must be ordered
separately; refer to contact
specification pages for details.

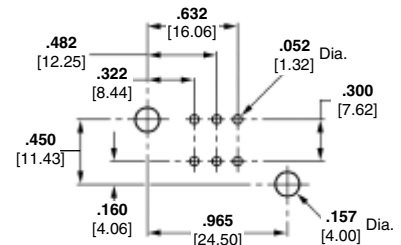
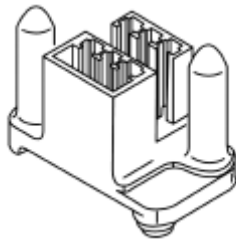

Recommended PC Board Layout

Material

Glass-filled polybutylene terephthalate
(PBT), black

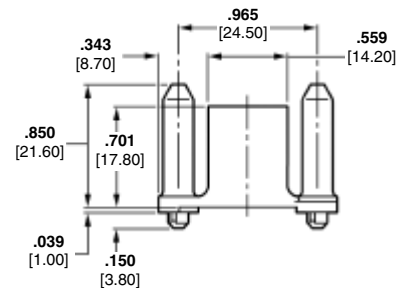
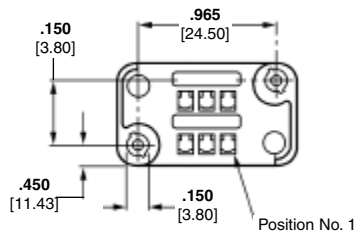

Note: All part numbers are RoHS compliant.

**AMP Drawer Series Connectors —
Special Blindmate Drawer Connectors** (Continued)

**Socket Housing,
10 Positions**

Part Number 343348-1

Accepts the following AMP-LEAF
Crimp Snap-In Contacts:

Part Number 343371-1 (strip form)
Part Number 583204-2 (strip form)

Contacts must be ordered
separately.

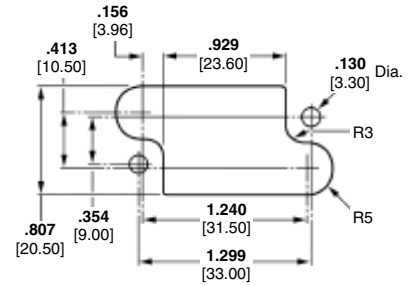
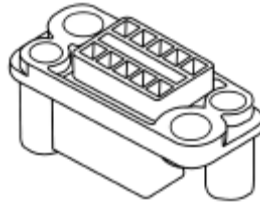

Recommended Panel Cutout

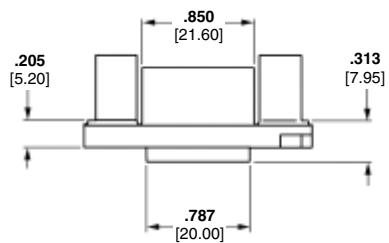

Material

Glass-filled polybutylene terephthalate
(PBT), black

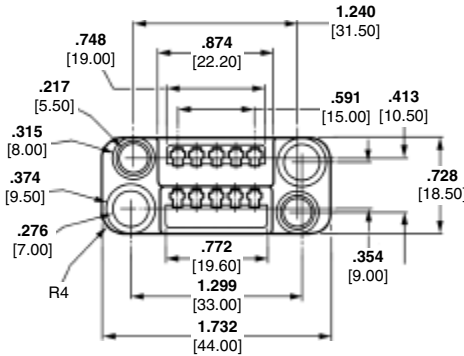

**Header Housing,
10 Positions**

Part Number 343347-1

Accepts AMP-LEAF Crimp Snap-In
Contact Part Number 343371-1
and Solder Dip Contact
Part Number 583294-2

Contacts must be ordered
separately: refer to contact
specification pages for details.

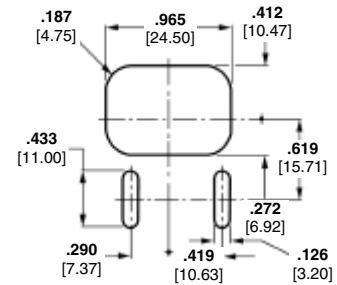
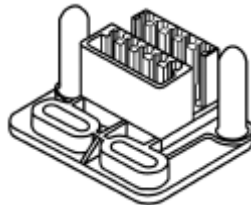

Recommended Panel Cutout

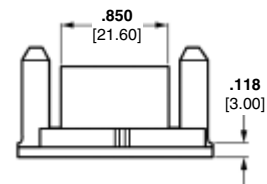

Material

Glass-filled polybutylene terephthalate
(PBT), black

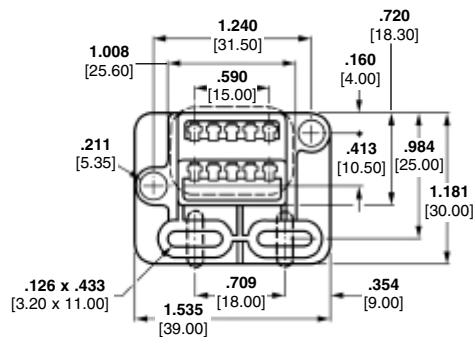

Note: All part numbers are RoHS compliant.

**AMP Drawer Series Connectors —
Special Blindmate Drawer Connectors** (Continued)

Crimp, Snap-In Contacts

Material and Finish

Phosphor bronze, plated as follows:

Plating A — .000100-.000200 [0.00254-0.00508] tin (lubricant must be used)

Plating B — .000030 [0.00076] min. gold in mating area, gold flash on remainder of contact, with entire contact underplated .000050 [0.00127] min. nickel

Plating C — .000015 [0.00038] min. gold in mating area, gold flash on remainder of contact, with entire contact underplated .000050 [0.00127] min. nickel

Plating D — .000030 [0.00076] min. gold over .000050 [0.00127] min. nickel in mating area, remainder of contact gold flash over .000015 [0.00038] min. nickel

Plating E — .000030 [0.00076] min. gold in mating area, with entire contact underplated .000050 [0.00127] min. nickel

Plating F — .000015 [0.00038] min. gold in mating area, with entire contact underplated .000050 [0.00127] min. nickel

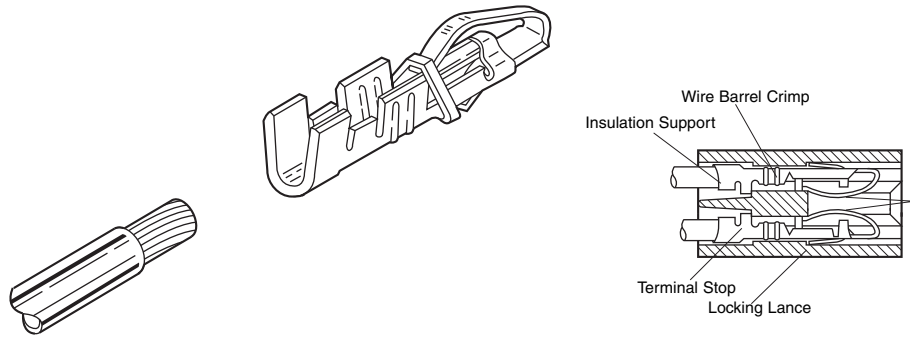

Wire Range AWG/mm ²	Insulation Range		Contact		Contact Finish	Applicator for AMP-O-LECTRIC Machine*	Hand Tool
	Single Wire	Double Wire	Loose Piece	Strip Form			
26-22 0.12-0.4	.050-.064 1.27-1.63	—	583990-3	583204-2	B	466366-2	90028-3
			—	343371-1	D		
			—	583361-2	A		
22-18 0.3-0.9	.055-.080 1.40-2.03	.120 3.05 Max.	583989-3	583361-3	B	466367-2	90017-3 (1 #22-20) 90028-3 (2 #22) 90101-3 (1 #20)
			583989-4	583361-4	C		
			—	583555-4	E		
			—	583555-6	F		
16 1.25-1.40	.108 2.74 Max.	.080-.160 2.03-4.06	583991-3	60151-6	B	466368-2	90031-8 (2 #18) 90101-3 (2 #20) 90101-3 (1 #16)

*Applicators are for AMP-O-LECTRIC Model "K" machines. Consult Tyco Electronics for applicators for other bench machines and lead-making machines.

- Notes:**
- Shorting contacts are available, consult Tyco Electronics.
 - Contacts and housings to accommodate .093 [2.36] thick PC boards can be made available, consult Tyco Electronics.

Technical Documents

Product Specifications

108-9013, 108-9043

Application Specification

114-9003

Instruction Sheets

408-6591, 408-7045, 408-7622,

408-7623, 408-7624, 408-7625,

408-7626

Crimp Inspection Sheet

CI 8050-33

Hand Crimping Tool



Contact Extraction Tool



Part Number	
Extraction Tool	Used with Housings
465195-1	480110-2, -5
	480142-2, -3
	582140-5
	582147-5
	582264-2
	582500-2
	582963-2
	583167-3
	583280-1
	583617-1
	583680-1
	583685-1
	583722-1
	583723-1
583724-1	
583725-1	
583726-1	
465195-2	480133-2

Dummy Contact

Material

Phosphor bronze

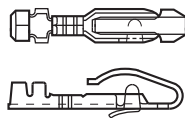

- Plain Finish—
Part Number 66084-1
Tin Finish—
Part Number 66084-2
Gold Finish—
Part Number 66084-3

Technical Documents

Instruction Sheet 408-7037

Note: All part numbers are RoHS compliant.

AMP Drawer Series Connectors — Standard Blindmate Drawer Connectors

Product Facts

- Designed for rack and panel applications
- Durable—withstands multiple mating/unmating
- Low insertion and withdrawal force
- Hermaphroditic contacts
- Accepts signal and power contacts
- Provides excellent creep distance
- Mated connectors dust-proof
- Configurations available in 8, 12, 16, 20 and 24 positions
- Contacts accept wire sizes 24-14 AWG [0.2-2.0mm²]
- Accept wire insulation diameter — .059-.154 [1.5-3.9]
- Recognized under the Component Program of the Underwriters Laboratories Inc. 

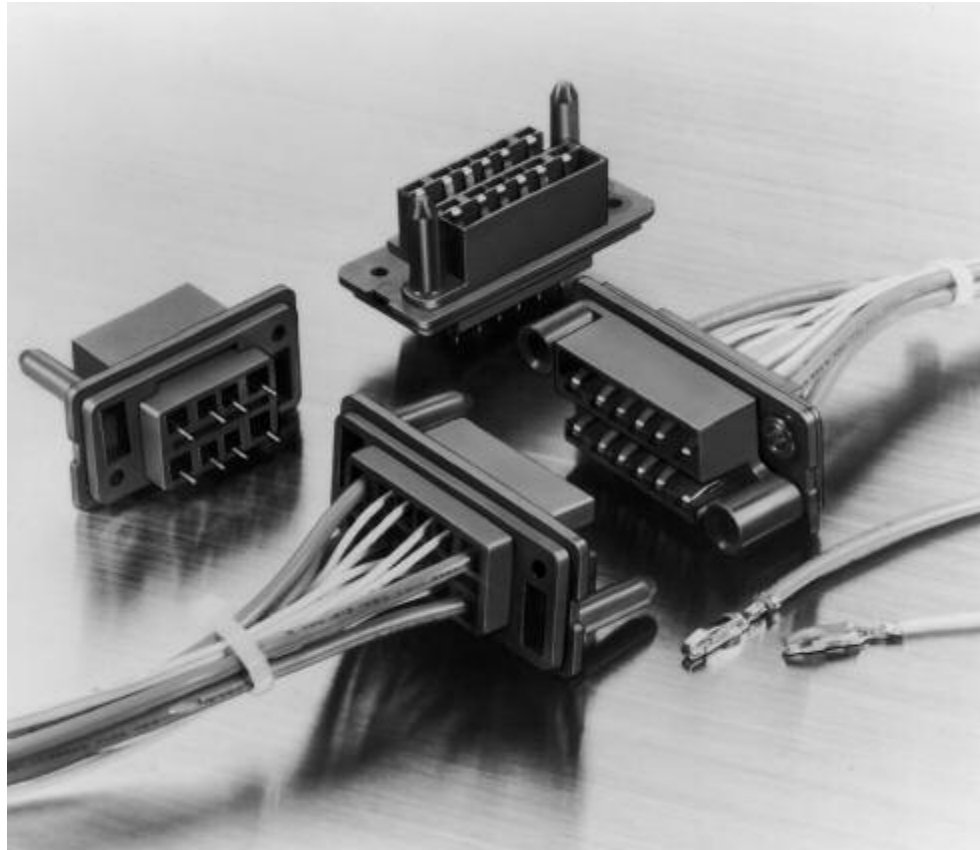

AMP Drawer Connectors are designed as an economical rack and panel connector. They are used in copying machines, control panels, power distribution boards, industrial equipment, power supplies and other electronic equipment.

Blindmate drawer connectors feature excellent durability and feature low insertion and withdrawal force. Leaf-type hermaphroditic contacts ensure reliable, positive contact.

Contacts are on .197 [5.00] centerlines for signal circuits, and .260 [6.60] centerlines for power circuits (2-circuits at each end of the double row of contacts) for a total of 4. Row-to-row spacing is .390 [9.90].

Housings are made of UL 94V-0 rated thermoplastic and feature molded-in guide pins and sockets for positive connector mating.

Other features include wire outlets which provide for sufficient creep distance, plus mated assemblies are completely dust-proof.

Additional economies are achieved through the use of strip-form contacts suitable for high-speed automatic machine terminations. For prototype, maintenance and repair applications, contacts are available in loose piece for easy termination with Tyco Electronics hand crimping tools.

Performance Specifications

Voltage Rating — 250 VAC

Current Rating —
 4 amperes — 24 AWG [0.2mm²] Wire
 5 amperes — 22 AWG [0.3-0.4mm²] Wire
 7 amperes — 20 AWG [0.5-0.6mm²] Wire
 8 amperes — 18 AWG [0.8-0.9mm²] Wire
 12 amperes — 16 AWG [1.25-1.4mm²] Wire
 15 amperes — 14 AWG [2.0mm²] Wire

Contact Resistance —
 10 milliohms max. (Initial)
 20 milliohms max. (Final)

Insulation Resistance —
 5000 milliohms min. (Initial)
 2000 milliohms min. (Final)

Dielectric Withstanding Voltage —
 2000 VAC/1 minute

Operating Temperature —
 -20°C to +120°C (Includes T-Rise)

Insertion/Extraction Force —
 Insertion—4 kg max. (Initial) —
 16-position
 Extraction—0.7 kg min. (Initial) —
 16-position

Durability —
 Tested to 1000 Mate/Unmate cycles

AMP Drawer Series Connectors — Standard Blindmate Drawer Connectors (Continued)

Plug Connectors, PC Board Mount

Material and Finish

Housing — Glass-filled polybutylene terephthalate (PBT), blue, 94V-0 rated

Contacts — Phosphor bronze, plated gold in contact area over nickel underplating; board mount tails are brass, plated tin over steel underplating

Related Product Data:

Performance Specifications — page 91

Mating Receptacles — page 93

Technical Documents

AMP Product Specification 108-5125

AMP Application Specification 114-5044

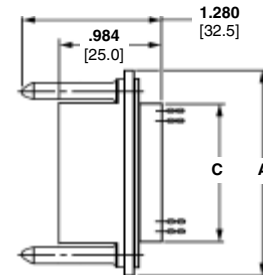
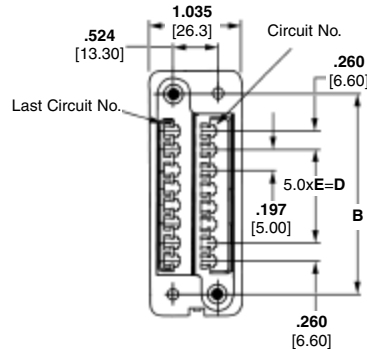

No. of Pos.	Dimensions					Plug Connector Part Numbers
	A	B	C	D	E	
8	2.016 51.2	1.500 38.0	1.055 26.8	.197 5.00	1	172653-2
12	2.409 61.2	1.890 48.0	1.449 36.8	.591 15.0	3	172653-3
16	2.803 71.2	2.283 58.0	1.843 46.8	.984 25.0	5	172653-1

Note: To ensure proper contact alignment, connectors must be mated during the soldering process.

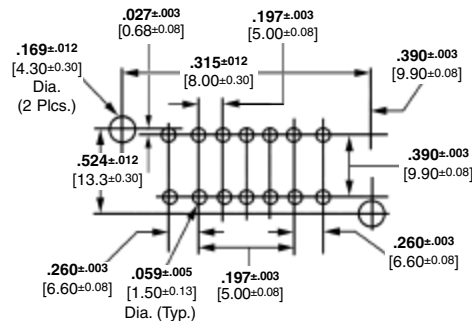

Recommended PC Board Layout

Note: All part numbers are RoHS compliant.

**AMP Drawer Series Connectors —
Standard Blindmate Drawer Connectors** (Continued)

**Housings for Crimp
Snap-In Contacts**

Material

Polybutylene terephthalate (PBT), blue,
94V-0 rated

Related Product Data

Performance Specifications —
page 91

Crimp Snap-In Contacts — page 94

Panel Cutout — page 94

Technical Documents

AMP Product Specification
108-5125

AMP Application Specification
114-5044

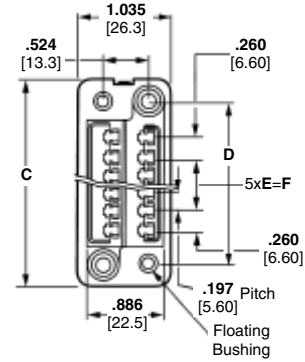
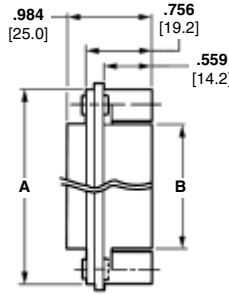

Receptacle

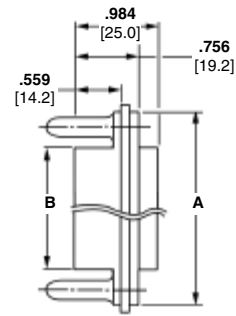
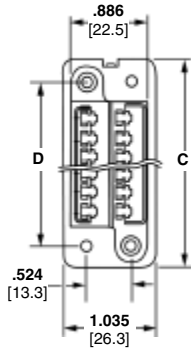

Plug

No. of Pos.	Dimensions						Receptacle		Plug	
	A	B	C	D	E	F	Floating Bushing Size	Part Numbers	Panel Mount Hole Diameter	Part Numbers
8	1.858 47.20	1.055 26.80	2.016 51.20	1.500 38.00	1	.197 5.00	.118 3.00	172070-1	.130 3.30	172063-1
							.157 4.00	172070-3	.169 4.30	172063-3
12	2.252 57.20	1.449 36.80	2.410 61.20	1.890 48.00	3	.591 15.00	.118 3.00	172069-1	.130 3.30	172061-1
							.157 4.00	172069-3	.169 4.30	172061-3
16	2.657 67.20	1.843 46.80	2.803 71.20	2.283 58.00	5	.984 25.00	.118 3.00	172068-1	.130 3.30	172059-1
							.157 4.00	172068-3	.169 4.30	172059-3
20	3.039 77.20	2.236 56.80	3.197 81.20	2.677 68.00	7	1.378 35.00	.157 4.00	173033-3	.169 4.30	173032-3
24	3.433 87.20	2.630 66.80	3.591 91.20	3.071 78.00	9	1.772 45.00	.118 3.00	172625-1	.130 3.30	172624-1
							.157 4.00	172625-3	.169 4.30	172624-3

Note: All part numbers are RoHS compliant.

AMP Drawer Series Connectors —
Standard Blindmate Drawer Connectors (Continued)

Crimp Snap-In Contacts
(Hermaphroditic)

Material and Finish

Phosphor bronze, plated gold in contact area (for length of .236 [6.0] from tip), with entire contact underplated nickel

Related Product Data

Performance Specifications —

page 91

Housings — page 93

Technical Documents

AMP Instruction Sheets
408-097J, 408-098J, 408-151J

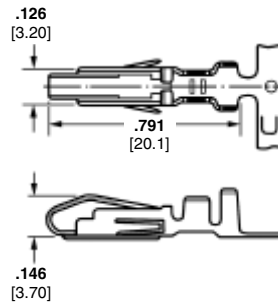

Wire Size Range		Insulation Dia. Range	Part Numbers		Applicator for AMP-O-ELECTRIC Machine*	Hand Tool Numbers
			Contact Strip Form	Loose Piece		
24-20	0.2-0.6	.059-.077 1.50-1.95	170311-1	170313-1	567324-2	724632-1
20-16	0.5-1.4	.071-.130 1.80-3.30	170484-1	170485-1	567241-2	724787-1
18-14	0.8-2.0	.091-.154 2.30-3.90	170312-1	170314-1	567325-2	724639-1

*Applicators are for Model "K" machines. Consult Tyco Electronics for applicators for other bench machines and lead-making machines.

Notes: 1. For applicable wire, use wire specified in UL 1015 or 1007.

2. Contacts for 18-14 AWG [0.8-2.0mm²] wire are used at the four corners of the connector as power contacts (8 required per assembly).

Extraction Tool **Part Number 723986-1**

Recommended Panel Cutout

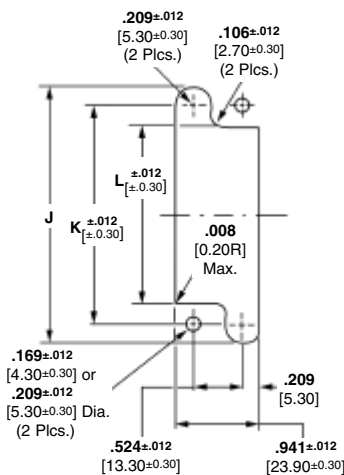

No. of Pos.	Rear Panel Mount Dimensions		
	J	K	L
8	1.913 48.60	1.500 38.00	1.110 28.20
12	2.307 58.60	1.890 48.00	1.504 38.20
16	2.701 68.60	2.283 58.00	1.898 48.20
20	3.094 78.60	2.677 68.00	2.291 58.20
24	3.488 88.60	3.071 78.00	2.685 68.20

Rear Panel Mount

Note: Mounting holes of .209 [5.30] dia. are used when mounting receptacle housings with .157 [4.0] long floating bushings and the mating plug housings. Panel thickness is .063 [1.60]. Panel cutout shown above is for use with plug housings. For receptacle housings, use the mirror-image cutout.

Note: All part numbers are RoHS compliant.

AMP Drawer Series Connectors — Hybrid Mini-Drawer Connectors

Product Facts

- Combine signal circuits and power circuits into one connector
- Power circuits can be used for high current of up to 15A
- Signal circuits accept CT connector in the back, reducing harnessing costs
- Power circuits use crimp-type tab and receptacle contacts
- Meet requirements for creepage distance and spatial distance for primary power supply as set forth in IEC-950, safety specifications for business machines and OA equipment. Creepage distance on active power side: 5mm
Spatial distance on active power side: 4.5mm

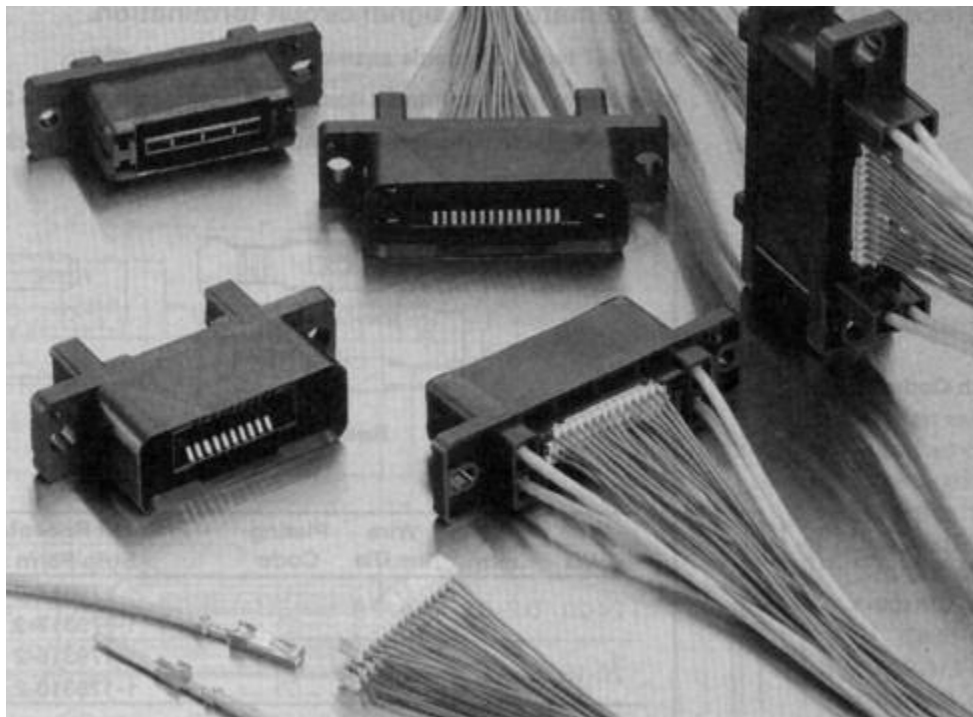

Technical Documents

Product Specification
108-60022
Application Specification
114-5182

Hybrid Mini-Drawer Connectors are designed for use in rack and panel application to serve as an I/O connector for copying machines, laser-beam printers and other OA equipment. They provide an economical means of combining into one connector signal circuits and power circuits which were packaged separately in the past.

A major design feature of these Hybrid Mini-Drawer Connectors is that Mini-Drawer Connectors mate with one another on the connector mating side and in the back, signal circuits accept a pre-terminated CT receptacle connector.

Also, for power circuits, crimp-type power contacts are used by inserting them into the four corners of Mini-Drawer Connector.

The housing has an integrated guide-pin and socket to facilitate mating of the connector halves. Provision is also made to prevent dust from entering.

This product line includes:

- 12-position connector (4 positions for power and 8 positions for signal circuits)
- 24-position connector (4 positions for power and 20 positions for signal circuits)
- 32-position connector (4 positions for power and 28 positions for signal circuits)

Drawer Connectors are available in the following types depending on application: For details contact our Sales Department

- Mini-Drawer Connectors
- Standard Drawer Connectors
- High Current Drawer Connectors.

Performance Data

- Voltage Rating** —
250V AC (power)
30V AC (signal)
- Current Rating** —
15A max. (power)
2A max. (signal)
- Contact Resistance** —
10mm Ω max. (power)
40mm Ω max. (signal)
- Insulation Resistance** —
100M Ω max.
- Dielectric Withstanding Voltage** —
1.8KV AC/min. (power)
1.0KV AC/min. (signal)
- Durability** — 3,000 cycles min.

Note: All part numbers are RoHS compliant.

**AMP Drawer Series Connectors —
Hybrid Mini-Drawer Connectors** (Continued)

Standard Width

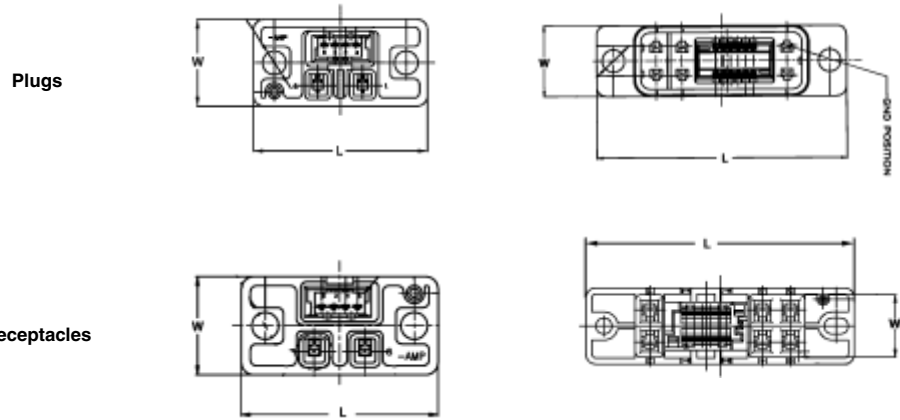

Type	Part Number	Number of Power Contacts	Number of Signal Contacts	L	W
Plug	292180-1	2	4	33	16.4
Receptacle	292184-1	2	4	33	16.4
Plug	1-292183-2	6	12	67	19
Receptacle	1-292186-2	6	12	67	19

Slim Width

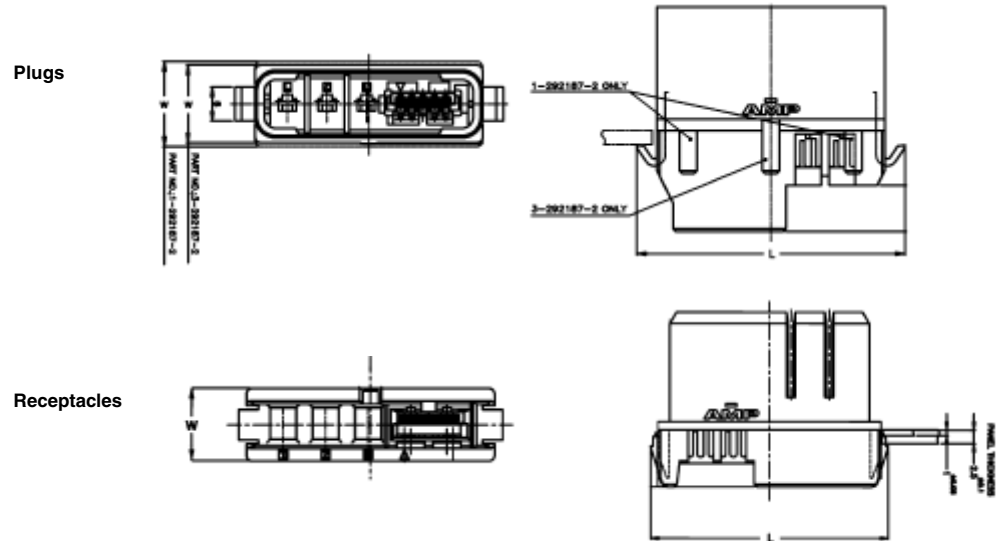

Type	Part Number	Number of Power Contacts	Number of Signal Contacts	L	W
Plug	1-292187-2	3	5	47.5	15
Receptacle	2-292190-2	3	5	43.5	12
Plug	3-292187-2	4	5	54.5	13.5
Receptacle	4-292190-2	4	5	50.5	12
Plug	2-292189-3	3	7	51.5	15
Receptacle	1-292192-3	3	7	47.5	12

Note: All part numbers are RoHS compliant.

**AMP Drawer Series Connectors —
Hybrid Mini-Drawer Connectors (Continued)**

CT Receptacle Connectors to Mate with Signal Circuit Terminator with Insulation Displacement Contacts

Receptacle Assemblies (Wire Application Side)

Material and Finish

Housing — UL94V-0 rated, glass-filled P.B.T. see chart below for color.

Contact — Pre-tinned phosphor bronze

Wire Size — AWG #28-26 (0.08-0.15mm²)

Insulation Dia. — 0.85-1.05mm

Wire Size — AWG #24 (0.20-0.22mm²)

Insulation Dia — 0.95-1.05mm² (For AWG #24 wire, see notes under the table)

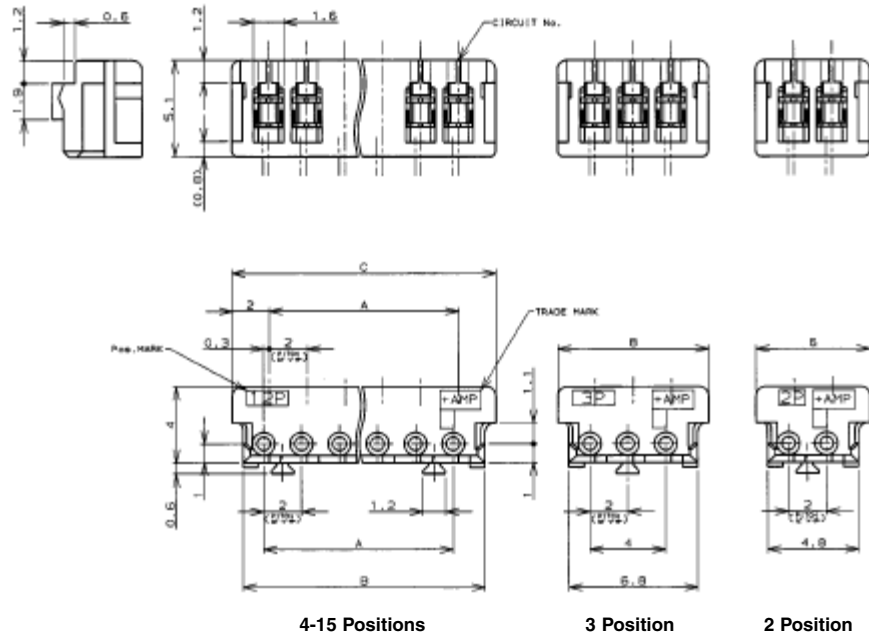

Cable Mounted Products

No. of Positions	Dimensions			Part Number	
	A	B	C	Receptacle Assembly**	
				AWG #28-26*	AWG #24***
2	2.0	4.8	6.0	173977-2	2-179694-2
3	4.0	6.8	8.0	173977-3	2-179694-3
4	6.0	8.8	10.0	173977-4	2-179694-4
5	8.0	10.8	12.0	173977-5	2-179694-5
6	10.0	12.8	14.0	173977-6	2-179694-6
7	12.0	14.8	16.0	173977-7	2-179694-7
8	14.0	16.8	18.0	173977-8	2-179694-8
9	16.0	18.8	20.0	173977-9	2-179694-9
10	18.0	20.8	22.0	1-173977-0	3-179694-0
11	20.0	22.8	24.0	1-173977-1	3-179694-1
12	22.0	24.8	26.0	1-173977-2	3-179694-2
13	24.0	26.8	28.0	1-173977-3	3-179694-3
14	26.0	28.8	30.0	1-173977-4	3-179694-4
15	28.0	30.8	32.0	1-173977-5	3-179694-5

* The color of housing is natural. Other colors available include blue, yellow and black. For details contact our Sales Department

** For wire to be used, contact our Sales Department as there are wires that have been tested by us and can be recommended for your use.

*** The color of housing is gray.

Note: All part numbers are RoHS compliant.

**AMP Drawer Series Connectors —
Hybrid Mini-Drawer Connectors (Continued)**

**CT Receptacle Contacts to
Mate with Signal Circuit
Termination with Crimp
Type Contacts**

Receptacle Contact

Wire Size AWG (mm ²)	Insulation Dia. (mm)	Material and Finish	Part Number		
			Strip Form	LP	Hand Tool
30-26 (0.05-0.12)	0.65-1.35	Phosphor bronze (0.20mm thickness), tin plated	179609-1	—	234169-1 (411-5711)
26-22 (0.12-0.35)	0.93-1.5		179227-1	179518-1	91572-1 (408-8547)

Note: Loose piece contacts, being small in size, are supplied in the form of a comb with 10 pieces on 7.5mm pitch. There is a slit at the root of each contact and it can be snapped off easily.

Cable Mounted Products

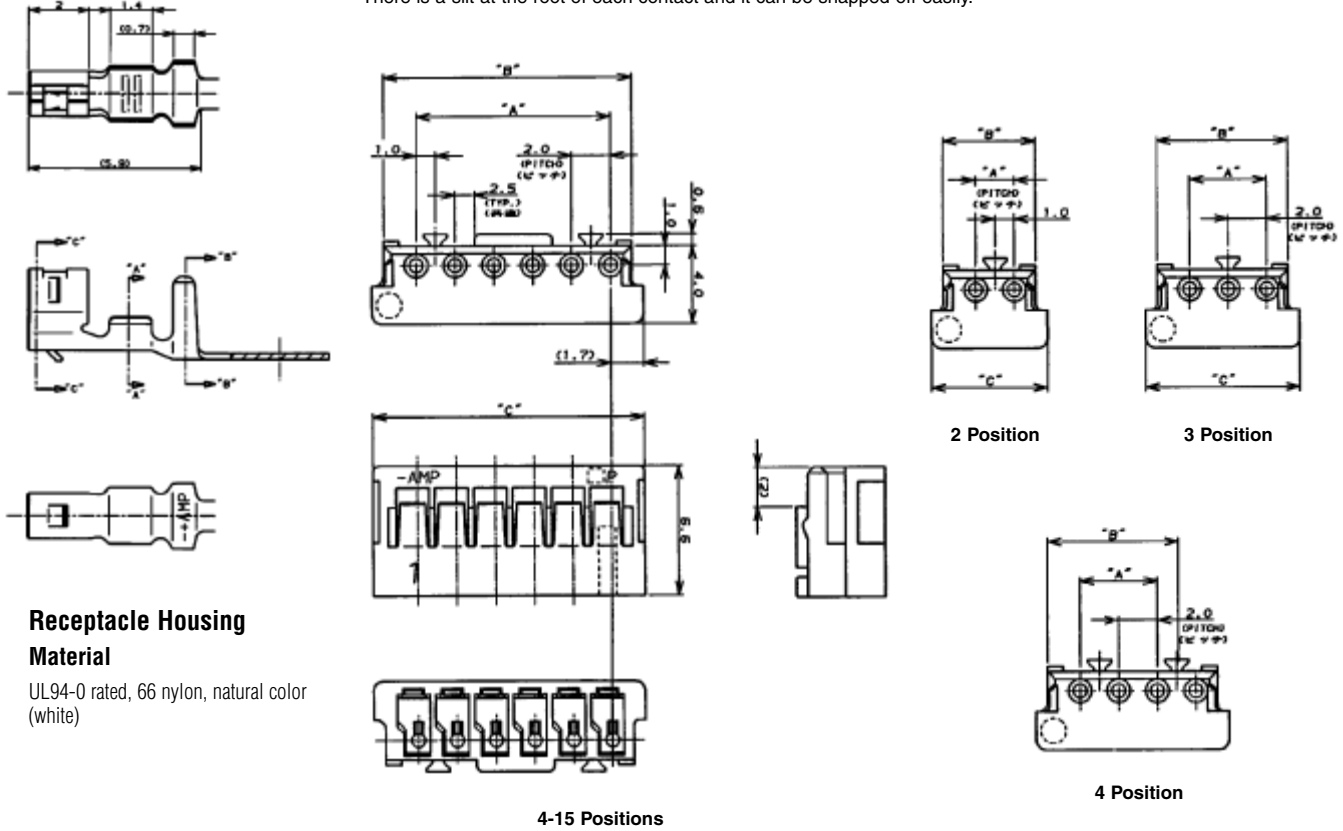

**Receptacle Housing
Material**

UL94-0 rated, 66 nylon, natural color
(white)



No. of Positions	Dimensions			Part Number Receptacle Assembly*
	A	B	C	
2	2.0	4.8	6.0	179228-2
3	4.0	6.8	8.0	179228-3
4	6.0	8.8	10.0	179228-4
5	8.0	10.8	12.0	179228-5
6	10.0	12.8	14.0	179228-6
7	12.0	14.8	16.0	179228-7
8	14.0	16.8	18.0	179228-8
9	16.0	18.8	20.0	179228-9
10	18.0	20.8	22.0	1-179228-0
11	20.0	22.8	24.0	1-179228-1
12	22.0	24.8	26.0	1-179228-2
13	24.0	26.8	28.0	1-179228-3
14	26.0	28.8	30.0	1-179228-4
15	28.0	30.8	32.0	1-179228-5

* The color of housing is natural. Other colors available include blue, yellow and black. For details contact our Sales Department

Note: All part numbers are RoHS compliant.

AMP-DUAC PL Connectors

Product Facts

- Wire to board connection system
- Improved DUAL-ACTION Contact Design — provides better contact lead-in and reduces contact mating force
- Sequenced contacts available for Mate-first Break-last operation
- 4, 6 and 12-position right angle headers and free hanging receptacles
- 4.2mm x 5.5mm centerline
- Receptacle contacts designed for 26-22 AWG stranded wire
- Recognized under Component Program of Underwriters Laboratories Inc., File No. E28476 
- Certified by Canadian Standards Association, File No. LR7189 

Technical Documents

Product Specifications
108-1646

Application Specifications
114-6067-Crimping Contacts

Qualification Test Report
501-394

Performance Data

Voltage Rating — 600 VAC

Current Rating — 9 amps maximum
in 2-position application

Low Level Resistance —
10 megohms max.

Dielectric Withstanding Voltage —
1500 VAC/min.

Insulation Resistance —
1000 Megohms minimum

Operating Temperature — -55°C to
+ 105°C [-67°F to +221°F]

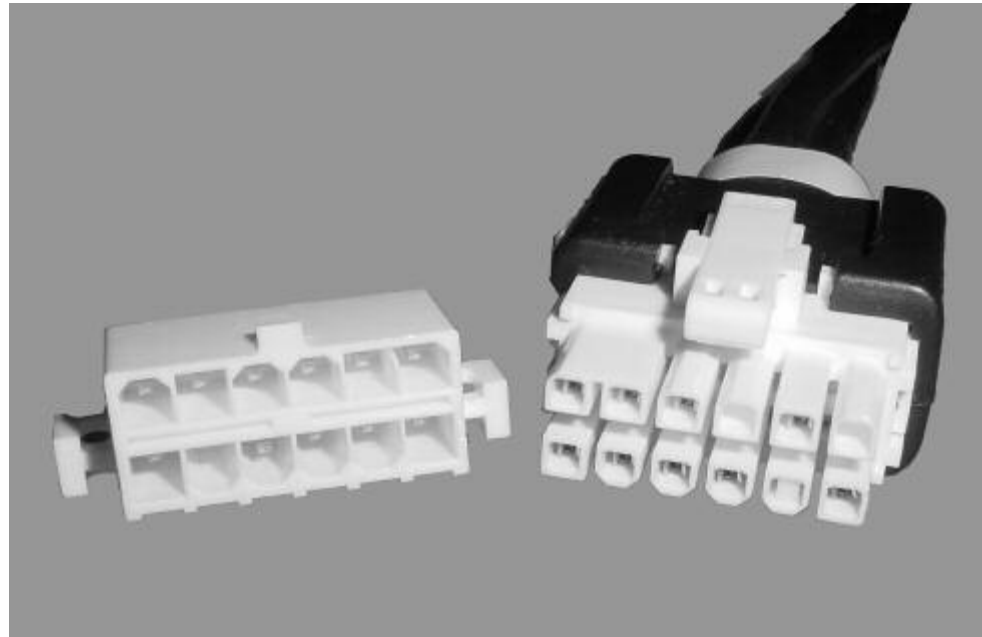

The latest addition to the 4.2mm Wire-to-Board Power Connectors is the AMP-DUAC PL Connector. This product uses the industry proven AMP-DUAC contacts with the addition of several housing improvements to offer significant overall improvements in connector reliability. The product is available in both component form and as fully assembled custom cable assemblies.

The AMP-DUAC PL housings are designed to guarantee that all electrical contacts are fully seated. The "PL" refers to "Positive

Locking" of the contacts. It is also referred to as terminal position assurance. Contacts are inserted into the receptacle housing and the contact lock is installed to lock all the contacts into position. If any one of the contacts is not fully inserted, the Contact Lock cannot be installed. This feature eliminates a common concern of operator fatigue and the resulting contact back-out, which occurs when a contact is not installed properly. An improved mounting flange has also been added for more secure printed circuit board mounting.

Finally, the housings have been re-designed to provide an improved latch, which offers a metal spring instead of the original plastic spring/latch. An extended latch arm is also available for hard to reach installations or where the connectors are stacked in close proximity.

All the housings are polarized to prevent mis-mating.

AMP-DUAC PL Connectors (Continued)

AMP-DUAC PL PCB Headers

Material

Housings — Nylon, UL 94V-0
Color, white

Contacts — Brass, tin-lead

Finish — 0.00038 [0.00030] gold in mating area, tin-lead in solder tail, all over 0.00127 [0.000050] nickel

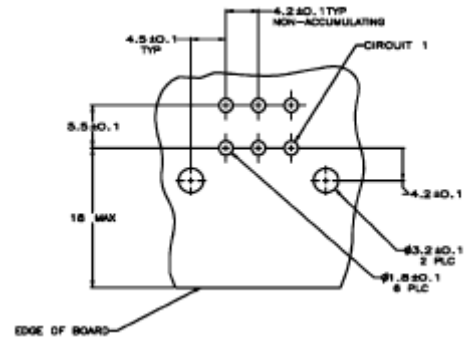
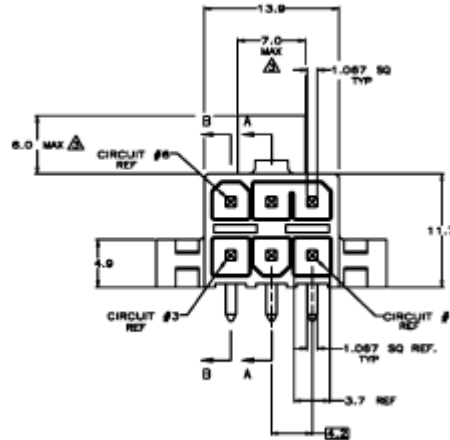
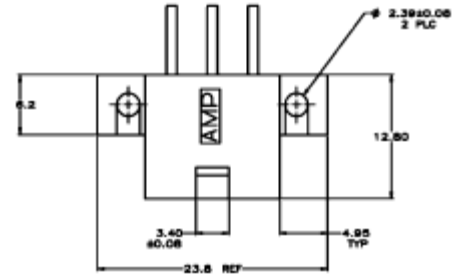
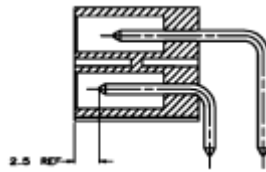
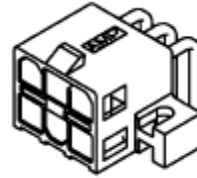

**Recommended Mounting Hole Pattern
For 1.78 Max. Thick PC Board
Component Side Shown**

No. Positions	Mate-First Break-Last Position #	Part Number
4	All Standard Length 3	5794172-2 5794172-3
6	All Standard Length 3	5794173-2 5794173-3
12	All Standard Length 4	5794176-2 5794176-3

Note: All part numbers are RoHS compliant.

AMP-DUAC PL Connectors (Continued)

AMP-DUAC PL Receptacles

Material

Housings — Nylon, UL94V-0
Color, White

Technical Documents — page 101

Contacts — page 109

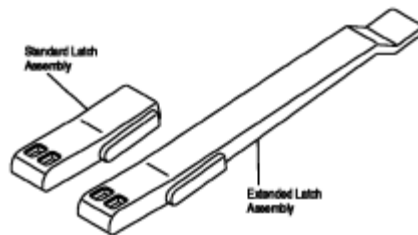
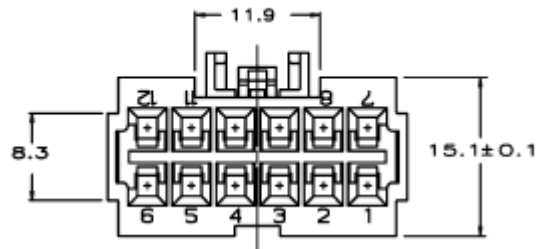
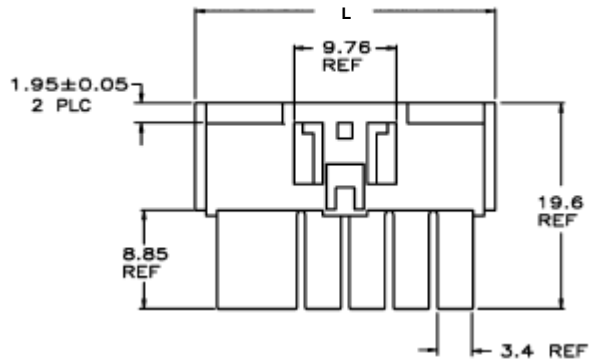
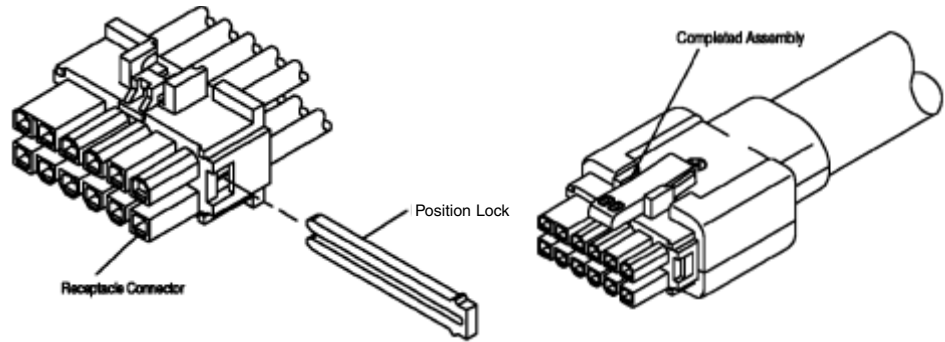

No. Positions	Dimension L	Part Numbers		
		Housing	Standard Latch	Extended Latch
4	15.9	794152-1*		
6	20.1	794153-1	794150	794149
12	28.6	794156-1		

*Latch items ordered separately
Optional keying plug — Part No. 794144-1

Note: Position Lock Required — use one per housing — Part No. 794145-3

Note: All part numbers are RoHS compliant.

“NEW” AMP-DUAC PL-II Connectors

Product Facts

- Wire-to-board connection system combining power and signal contacts
 - 10A power contacts
 - 4A signal contacts
- High conductivity copper alloy power contacts yield 30% gain in current carrying capacity compared to alternative designs
- Dual Action Contact (DUAC) design — reduces mating forces by up to 50% compared to alternative designs.
- 9 power and 20 signal contacts
- Positive Lock (PL) feature on both Power and Signal contacts ensures contacts remain in position in cable receptacle
- Pin and Receptacle contacts offered in three sizes:
 - 16 AWG
 - 18 AWG
 - 20-22 AWG
- Wide 5.2 X 5.5mm contact spacing allows for 300V applications.
- Recognized under the Component Program of Underwriters laboratories Inc., File No. E28476



The new AMP-DUAC PL-II Connectors bring both shielding and a power / signal mix to the popular DUAC product family. In addition, the wider contact spacing and the use of high conductivity materials results in a higher current carrying capacity than the original 4.2 mm pitch DUAC product.

The deep back shell allows for gathering the larger wire and insulation diameters involves with combination power / signal and shielding all in the same cable. Traditional signal connectors do not accept the range of wire sizes covered by the DUAC PL-II product.

For applications involving higher voltage cabled power distribution, this product is the ideal solution. The DUAC PL-II connector uses the original industry proven dual-action contact (DUAC) design which provides a lower mating force and less plating wear than alternate contact designs. The signal contacts also feature a twin-cantilever beam that mates on the milled contact surface to provide low plating wear and high long-term reliability.

The cable mounted receptacle uses the popular “Positive Lock” devices proven throughout the automotive industry to ensure all the contacts are fully seated. The “positive locks” are also referred to as “terminal position assurance”. If any one of the contacts is not properly/ completely installed into the housing, then the “Positive Lock” can not be installed. This feature eliminates the common concern of operator fatigue and the resulting contact back-out which occurs when a contact is not properly seated.

The shielding system fully encapsulates the inner conductors and cable braids and provides a reliable conduction to the faceplate of the mating equipment.

Finally, the cable retention is accomplished through two rear-accessed over molded jackscrews for easy installation and removal.

Technical Documents

Product Specification
108-2218

Application Specification
Contact Tyco Electronics

Performance Data

Voltage Rating — 600 VAC

Current Rating —
10 Amps max on a single contact
6 Amps on each contact in 48 pos.
connector

Low Level Resistance —
10 milliohms max

Insulation Resistance —
1000 Megohms minimum

Operating Temperature —
-40°C to +105°C

Materials

Housing Material — PBT, UL 94V-0

Colors —
Plugs and Receptacles — Black
Positive Locks — White

“NEW” AMP-DUAC PL-II Connectors (Continued)

PCB Plug
Part Number 6469602-1

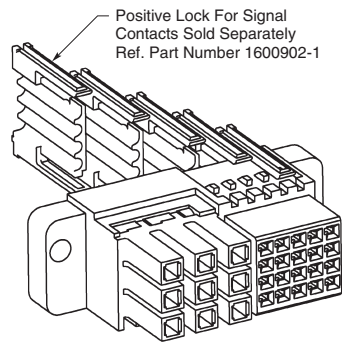
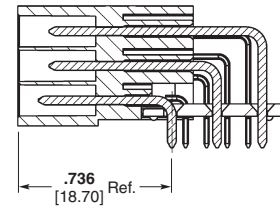
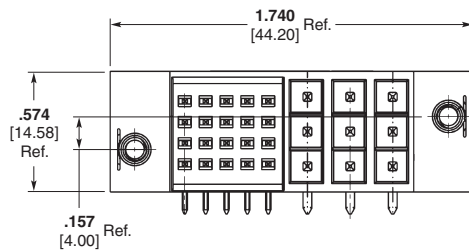
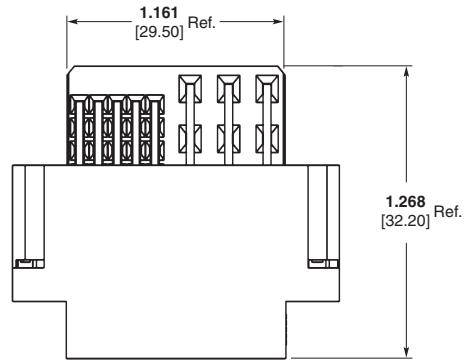

Free-Hanging Receptacle
Shown with Positive Locks

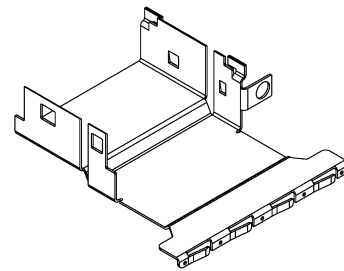

Shield

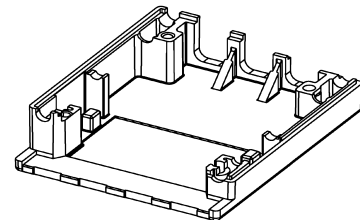

Cable Clamp

Note: Other cable components required. Cable receptacle components shown not sold separately. Receptacle only sold as part of a finished cable assembly.

Note: All part numbers are RoHS compliant.

“NEW” AMP-DUAC UPC Connectors

Product Facts

- Wire-to-wire connection system
- High conductivity copper alloy contacts yield 30% gain in current carrying capacity compared to alternative designs
- Dual Action Contact (DUAC) design — reduces mating forces by up to 50% compared to alternative designs
- Sequenced contacts for Make-First-Break-Last operation
- 48 and 66 position housings
- 4.4mm X 5.3mm contact grid
- Pin and Receptacle contacts offered in three sizes:
 - 16 AWG
 - 18 AWG
 - 20-22 AWG
- Recognized under the Component Program of Underwriters laboratories Inc., File No. E28476

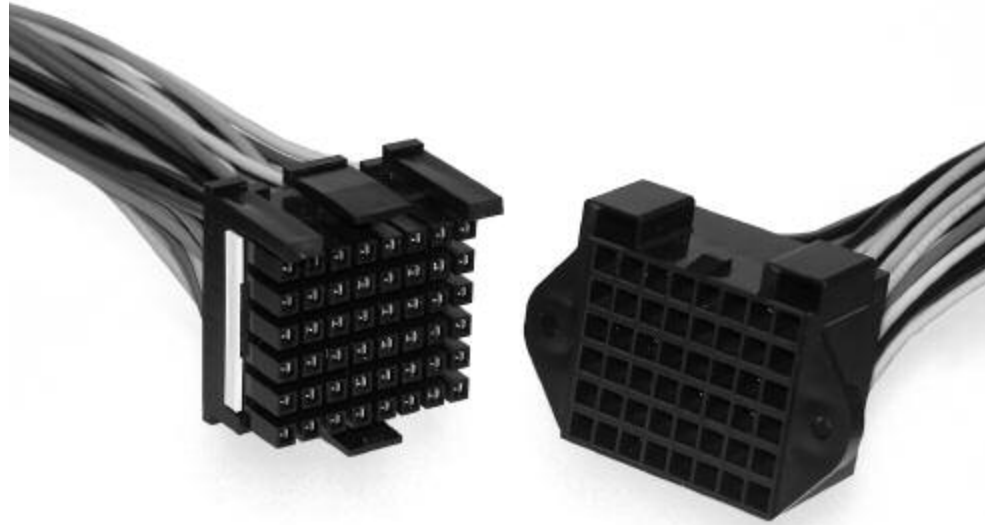

The latest addition to the AMP-DUAC product family is the AMP-DUAC UPC connector. The UPC connector offers much higher pin counts and a variety of product improvements to make the connector more reliable and easier to use. The UPC connector uses the original industry proven dual-action contact (DUAC) design along with very high conductivity copper alloys to improve the current carrying capacity.

The first noticeable difference of the UPC connector is the large pin count. With either 48 or 66 positions, the housing can serve as a common mating I/O point where multiple low current power connector cables are combined into one interface. Other connectors would yield an excessive mating force when mating this number of wires, however, the low mating force of the DUAC / UPC connector allows up to 66 wires to be mated with less than a 20 lb mating force.

The next key improvement is the use of molded-in guide pins. The guide pins make the mating process very easy and provide a visual polarization of the connector. The housings are so easily mated they practically “fall together”.

The use of two locking latches ensures a more secure connection and the screw-mounts for the panel mounted plug provide better retention than plastic latches.

Finally, the free-hanging receptacle uses the popular “Positive Lock” device to ensure all the contacts are fully seated. The “positive locks” are also referred to as “terminal position assurance”. If any one of the contacts is not properly/ completely installed into the housing, then the “Positive Lock” can not be installed. This feature eliminates the common concern of operator fatigue and the resulting contact back-out which occurs when a contact is not properly seated.

Technical Documents

Product Specification

108-2248

Application Specification

114-13195

Performance Data

Voltage Rating — 600 VAC

Current Rating —

11 Amps max on a single contact
4 Amps on each contact in 48 pos. connector

Low Level Resistance — 10 milli-ohms max

Insulation Resistance — 1.2 E16 ohms minimum

Operating Temperature — -40°C to +105°C

Materials

Housing Material — PBT, UL 94V-0

Colors —

Plugs and Receptacles — Black
Positive Locks — White

“NEW” AMP-DUAC UPC Connectors (Continued)

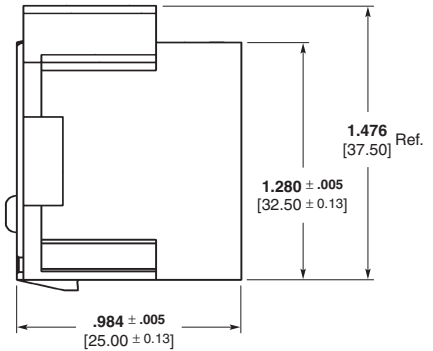
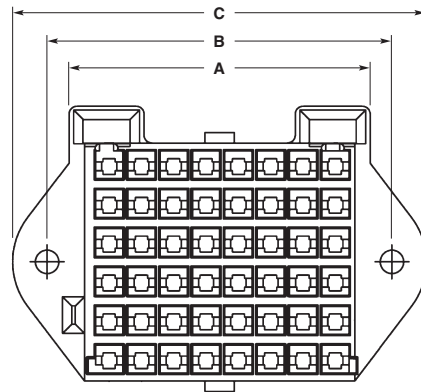
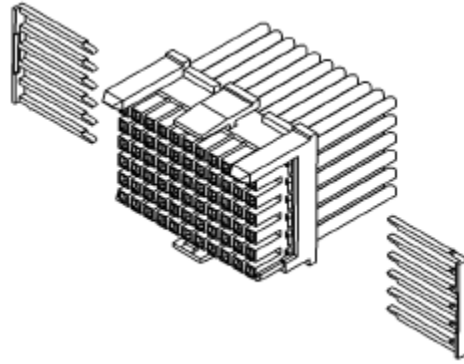

Panel Mount Plug
(Accepts contacts on page 108)

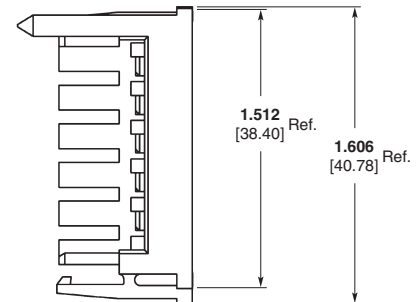
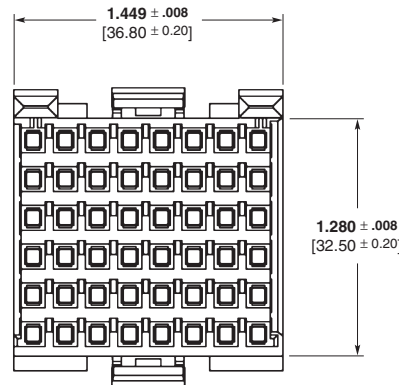

Free-Hanging Receptacle
(Accepts contacts on page 109)

Size (No. Circuits)	Panel Mount Plug	Dimensions			Free-Hanging Receptacle*	Positive Lock*
		A	B	C		
48	1934142-1	1.61 41.0	1.85 47.0	2.22 56.4	1934144-1	1469910-1
66	1934143-1	2.13 54.2	2.37 60.2	2.74 69.6	1934145-1	1934017-1

*Two (2) required for each receptacle housing. Not used in plug housings.

Note: All part numbers are RoHS compliant.

Contacts for AMP-DUAC PL, PL-II and UPC Connectors

Materials — High Conductivity
Copper Alloy
Finish — Pre-Tin or Gold Plated

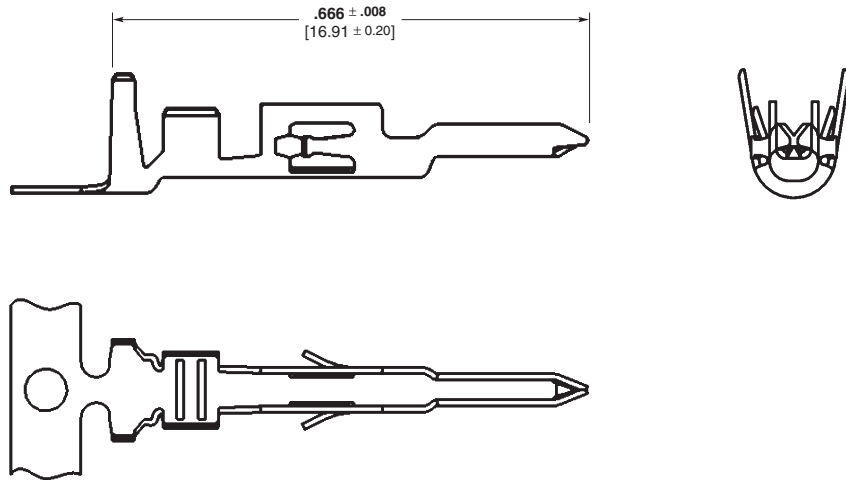

Cable Mounted Products

Contacts, Male

Technical Documents

Product Specification

108-2218 AMP-DUAC PL
108-2248 AMP-DUAC UPC

Application Specification

114-6067 AMP-DUAC PL
114-13195 AMP-DUAC UPC

DUAC PL or UPC Contacts

Wire Size Range AWG [mm ²]	Ins. Dia. Range	Plating	Part Number (Continuous Strip)
22-20 [0.3-0.5]	.590-.094 [1.50-2.40]	Tin	794576-1*
18 or 18+22 [0.8-1.1]	.087-.154 [2.20-3.90]	Gold	1934185-4
16 or 2 @ 18 [1.3-1.6]	.098-.173 [2.50-4.40]	Gold	1934184-4

Application Equipment: Extraction Tool 1976132

*Made from Phosphor-Bronze material (low conductivity)

Note: All part numbers are RoHS compliant.

Contacts for AMP-DUAC PL, PL-II and UPC Connectors (Continued)

Materials — High Conductivity
Copper Alloy
Finish — Gold Plated

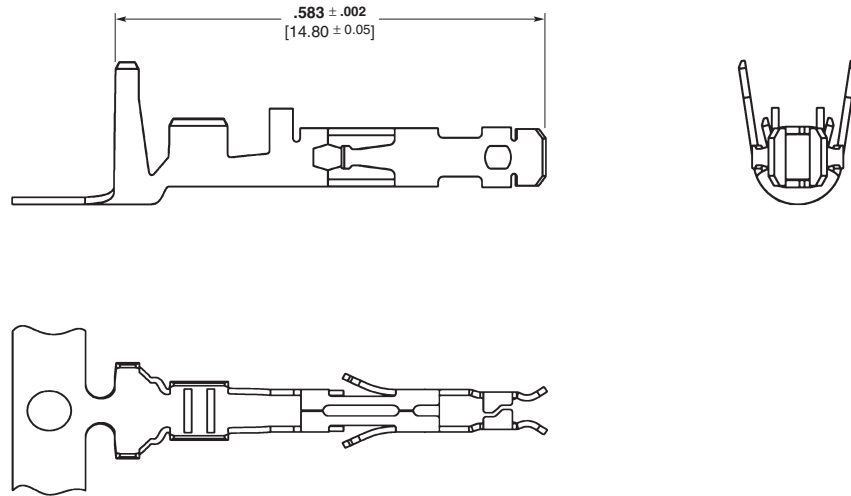

Contacts, Female

Technical Documents

Product Specification

108-2218 AMP-DUAC PL
108-2248 AMP-DUAC UPC

Application Specification

114-6067 AMP-DUAC PL
114-13195 AMP-DUAC UPC

DUAC PL or UPC Contacts

Wire Size Range AWG [mm ²]	Ins. Dia. Range	Plating	Part Number (Continuous Strip)
22-20 [0.3-0.5]	.590-.094 [1.50-2.40]	Gold	1934193-4
18 or 18+22 [0.8-1.1]	.087-.154 [2.20-3.90]	Gold	1934183-4
16 or 2 @ 18 [1.3-1.6]	.098-.173 [2.50-4.40]	Gold	1934182-4

Application Equipment: Extraction Tool 1976382

Note: All part numbers are RoHS compliant.

Other Soft Shell Pin & Socket Connectors

Product Facts

AMP .093 and .062 Commercial Pin and Socket Connectors

- Economical grade, wire-to-wire connectors
- Dual contact locking lances provide optimum contact stability
- Panel mount or free-hanging versions
- Voltage rating: 250 VAC or VDC
- Standard density (.093" diameter pin contact), .198" centerline, 1-15 positions; 13 A rating
- High density (.062" diameter pin contact), .145" centerline, 1-9 positions; 7 A rating

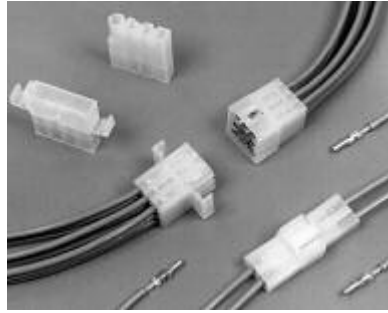

AMP Commercial MATE-N-LOK Connectors

- Standard density, wire-to-wire and wire-to-board connectors
- .200" centerline
- 1-16 positions
- Panel mount or free hanging
- Ratings: 19 A, 250 VAC
- Hot side is egg-crated for safety
- Locking devices are integral part of design

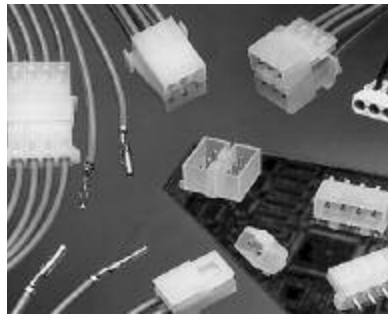

AMP Universal MATE-N-LOK and Universal MATE-N-LOK II Connectors

- .250" centerline; 1-15 and 2-15 positions, respectively
- Standard density, wire-to-wire and wire-to-board capability
- Panel mount or free hanging
- Ratings: 19 A, 600 VAC or VDC
- Contacts protected in the housings
- Seals available for splash protection (Universal MATE-N-LOK Connectors only)



For more Information Order Catalog 82181, "Soft Shell Pin and Socket Connectors"

Other Soft Shell Pin & Socket Connectors (Continued)

Product Facts

AMP Mini-Universal MATE-N-LOK and Mini-Universal MATE-N-LOK 2 Connectors

- High density, .163" centerline; 1-24 and 2-24 positions, respectively
- Wire-to-wire and wire-to-board capability
- Ratings: 600 VAC or VDC; 9.5 A and 10.5 A, respectively
- Contacts protected in the housings
- Seals available for splash protection (Mini-Universal MATE-N-LOK Connectors only)

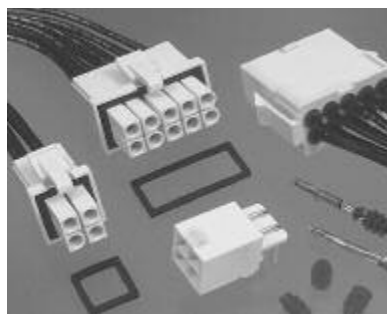

AMP Micro MATE-N-LOK 3mm Connectors

- High density, wire-to-wire and wire-to-board connectors
- 3 mm centerline, 2-24 positions
- Ratings: 5 A, 250 VAC
- Dual beam receptacle contact design for improved reliability
- Panel mount or free hanging
- PCB headers are available in vertical and right angle versions; thru-hole or surface mount

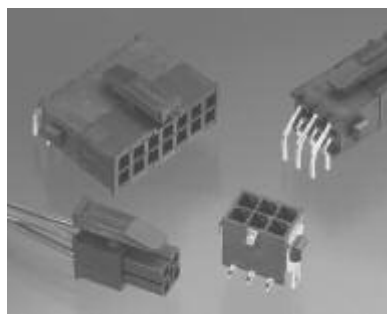

AMP 4.2 mm PE Series Connector System

- High density, wire-to-wire, wire-to-board and wire-to-panel connectors
- 4.2 mm centerline
- Single-row housings (3, 4 and 5 positions); Double-row (2-24 positions, even only)
- Ratings: 9 A max. (2 pos.), 600 VAC
- 18-22 AWG pins and sockets, RoHS compliant
- Nylon housings, UL 94V-2 and 94V-0
- Positive latch design
- Intermateable and interchangeable with Molex Mini-Fit, Jr. and intermateable with AMP-DUAC connectors

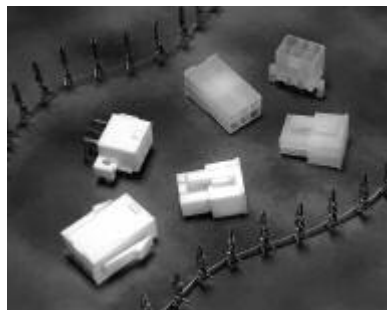



For more Information Order Catalog 82181, "Soft Shell Pin and Socket Connectors"

AMPINNERGY Products

**Wire-to-Wire (WTW)
Connectors**

Product Facts

- Rated to 600 VAC (RMS)
- Flame retardant housings 94V-0
- Housings, adapters, and power terminals keyed for proper assembly
- Stackable housings provide easy wire routing
- Built-in interlocking features better resist shock and vibration
- Usable as in-line, panel and surface mount connector
- Available in six different colors for circuit coding
- Two power terminals accommodate 10-12 AWG and 14-16-18 AWG wire
- UL Recognized, File No. E28476 
- CSA Certified, File No. LR7189 
- VDE Registered #5133

Technical Documents

Product Specification
108-1373 AMPINNERGY WTW Connectors

Application Specification
114-6051

Instruction Sheets
408-3277 AMPINNERGY Wire-To-Wire Stackable Connectors
408-3198 Inspection of AMPINNERGY System Power Contacts

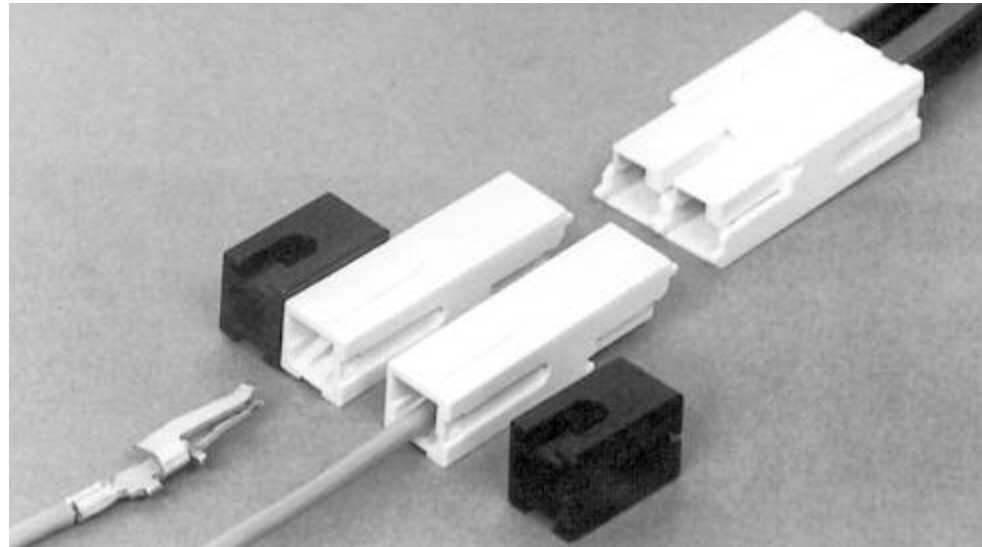

AMPINNERGY WTW Connectors provide a reliable and efficient means of interconnecting conductors to carry up to 600 VAC in power circuits or networks.

These Connectors consist of mating hermaphroditic, flame retardant polycarbonate housings into which terminated power contacts are inserted. Stackable in four directions through the use of molded interlocking keyways, the connectors make wire routing and dressing orderly and easy. Depending upon conductor

size and number of conductors in the connector configuration, the current rating ranges from 10 to 55 amperes.

For more information, request Catalog 1308885.

AMPINNERGY Products (Continued)

Wire-to-Board (WTB) Connectors

Product Facts

- Ratings: 600 VAC (RMS), current rating 12-35 amps
- Receptacles polarized to plug
- Receptacles and plugs available in 2 through 8 positions
- Vertical receptacle polarized to PCB
- Receptacle contacts have dual solder posts for efficient heat dissipation, low millivolt drop and mechanical strength
- Receptacles may be mounted on PCBs .062" to .125" thick
- Plugs have positive latching to receptacles
- Removable crimp contacts latch firmly in plug
- Crimp contacts accommodate 10-12 AWG or 14-16-18 AWG conductors
- UL Recognized, File No. E28476
- CSA Certified, File No. LR7189

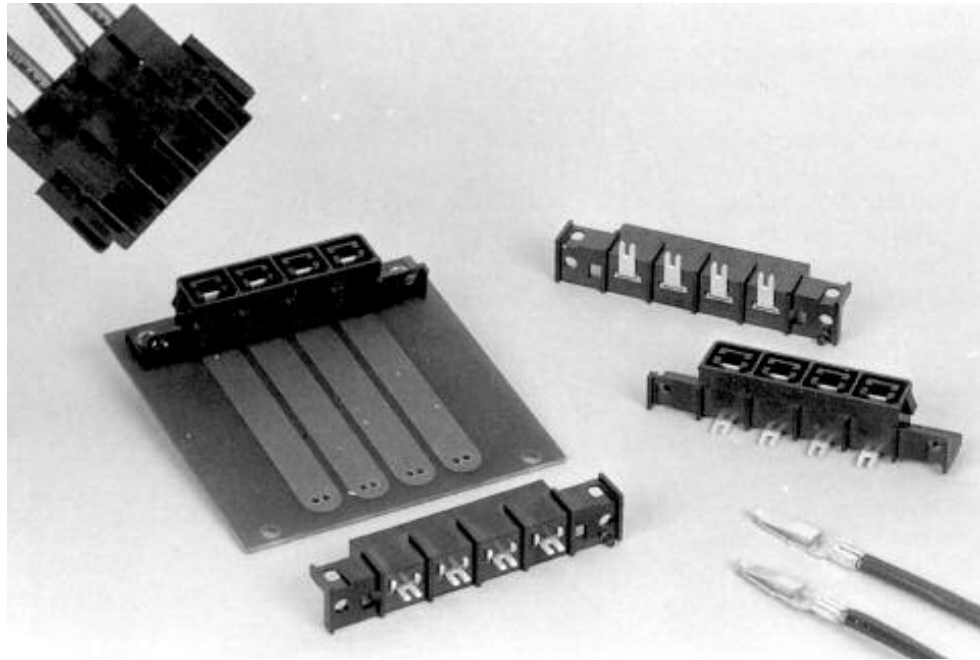

AMPINNERGY WTB Connectors provide a convenient and efficient means of delivering up to 600 VAC to component printed circuit boards and other power distribution devices in computers and peripherals, telephone systems and appliances. These connectors also have automotive and industrial applications.

Both the vertical and right angle receptacles are polarized for mating to the plugs.

Technical Documents

Product Specification

108-1349 AMPINNERGY WTB Connectors

Application Specification

114-6044 AMPINNERGY WTB Connectors

Instruction Sheets

408-3236 Installation of AMPINNERGY WTB Connectors

408-3198 Inspection of AMPINNERGY Contacts

For more information, request Catalog 1308885.

Circular (CPC) Connectors for Commercial Signal and Power Applications

Cable Mounted Products

Product Facts

- Lightweight, all-plastic and metal-shell connectors
- CPC connectors are UL 94V-0 rated and made of stabilized, heat resistant, self-extinguishing thermoplastic material
- Metal-shell CPC connector housings made of UL 94V-0 rated thermoplastic
- Operating temperature range: -55°C to +125°C
- Available in panel or chassis mount and free-hanging configurations
- Quick connect/disconnect capability with thread assist, positive detent coupling
- Built-in pin and socket protection
- Polarized for proper mating of connector halves
- Special connector configurations offer special solder and posted contacts, special receptacles with or without threaded inserts
- Full complement of optional accessories
- Recognized under the Component Program of Underwriters Laboratories Inc.  for 250 VAC, rms or 250 VDC, Service‡; Series 1 and Series 3 (600 V); Series 2, Series 4, Series 5 and Series 6 (250 V)
File No. E28476

‡Select connectors are recognized for 600 volts service.

- Certified by Canadian Standards Association,  File No. LR 7189
- Certain products meet VDE Standard 0627 

For more information, request Catalog 82021.



- Produced under a Quality Management System certified to ISO 9001

A copy of the certificate is available upon request.

Connector series for different interconnection requirements:

- Series 3—Low density, power applications with Type XII contacts capable of carrying up to 35 amperes of current
- Series 4—Combination of standard and power density application with Type III+ and Type XII contacts
- Series 5—Power density application with Size 8 screw machined and precision formed contacts
- Series 6—Combination of standard and power density application with Type III+ and Size 8 contacts

Type XII, Precision Formed, Crimp Contacts



Male

Female

High Current Type XII Crimp Contacts



High Current Type XII Socket

High Current Type XII Pin

Circular (CPC) Connectors for Commercial Signal and Power Applications (Continued)

Connector Series and Types

Series 3—Power Contacts

Series 3 connectors accept Type XII power contacts which can carry up to 25 amps per contact. These contacts will accommodate a wire size range of 16 to

10 AWG [1.4 to 5 mm²]. Two connector sizes are available in both standard and reverse sex connector arrangements **3 and 7 positions**.

Series 4—Combination Size 16 and Power Contacts

Series 4 connectors accept Size 16 Multimatch and Type XII power contacts, combining the signal and coaxial circuit capabilities of Series 1 connectors with the

power circuit capabilities of Series 3 connectors. Available in two connector sizes offering power mixing combinations totaling **16 and 22 positions**.

Series 5—Power Contacts .125 POWERBAND

Series 5 connectors combine the revolutionary performance of the new AMP POWERBAND Contact, high current contact in configurations similar to the Series 3 connectors. AMP POWERBAND contacts offer the electrical performance of the best Mil Spec

Size 8 screw-machined contacts with the economy and productivity of strip-fed, precision formed contacts. Series 5 connectors are environmentally sealable to meet IEC IP 65 and IP 67 specifications.

Rated at 600 VAC or VDC, 45 amperes maximum in a single contact, the connectors are available in free-hanging and panel-mount applications — **one connector configuration containing three .125 POWERBAND contacts**.

Series 6—Combination, Size 16 and .125 POWERBAND Contacts

Series 6 combines the high current and environmental sealing capability of Series 5, POWERBAND contacts, and the reliability of signal carrying, low current Type III+ contacts. This

combination of power and signal contacts is offered in **one connector configuration containing two .125 POWERBAND contacts and eight Type III+ signal pin and socket contacts**.

Metal-Shell, Circular Plastic Connectors (Series 3 and 4)

Metal-Shell CPC connectors consist of a black thermoplastic insert in a nickel-plated, zinc alloy shell. These connectors

are currently available in **shell sizes 14, 22 and 28, and in two basic configurations consisting of plugs and square flange receptacles**.

Circular (CPC) Connectors for Commercial Signal and Power Applications (Continued)

Type XII, Precision Formed, Crimp

Test Current Rating

Silver or Gold — 35 amperes ‡

Tin Lead — 15 amperes ‡

‡Single contact, free-air test current; not to be construed as contact rating current. Use only for testing.



Male



Female

Cable Mounted Products

High Current Type XII Crimp Contacts

An initial T-Rise test in free air has shown a 60 amp capability with a 30° T-Rise with 8 gage wires.



High Current Type XII Socket



High Current Type XII Pin

High Current Products (LOUVERTAC Contacts)

Product Facts

- Pins and sockets have low insertion force
- High current ratings with very low resistance
- All plated products are gold or silver plated
- LOUVERTAC bands have a temperature range from -196°C to $+200^{\circ}\text{C}$ available
- Formed bands are available for up to 1.250 [31.75] pin diameter

The transfer of high current with manageable insertion and withdrawal forces has always presented a challenge to the connector industry.

LOUVERTAC bands provide a unique means of transferring high amperage with a resultant space and weight savings. Tyco Electronics

offers a wide range of pin and socket sizes for your applications. Strip and formed LOUVERTAC bands are also offered for customer use in their own contact design. The wide variety of flat and formed male and female bands provide the ability to design electrical connections more

inexpensively and quickly. LOUVERTAC products are your high current applications solution.

The variety of pins and sockets available from Tyco Electronics provide a quick and simple solution to most high current applications.

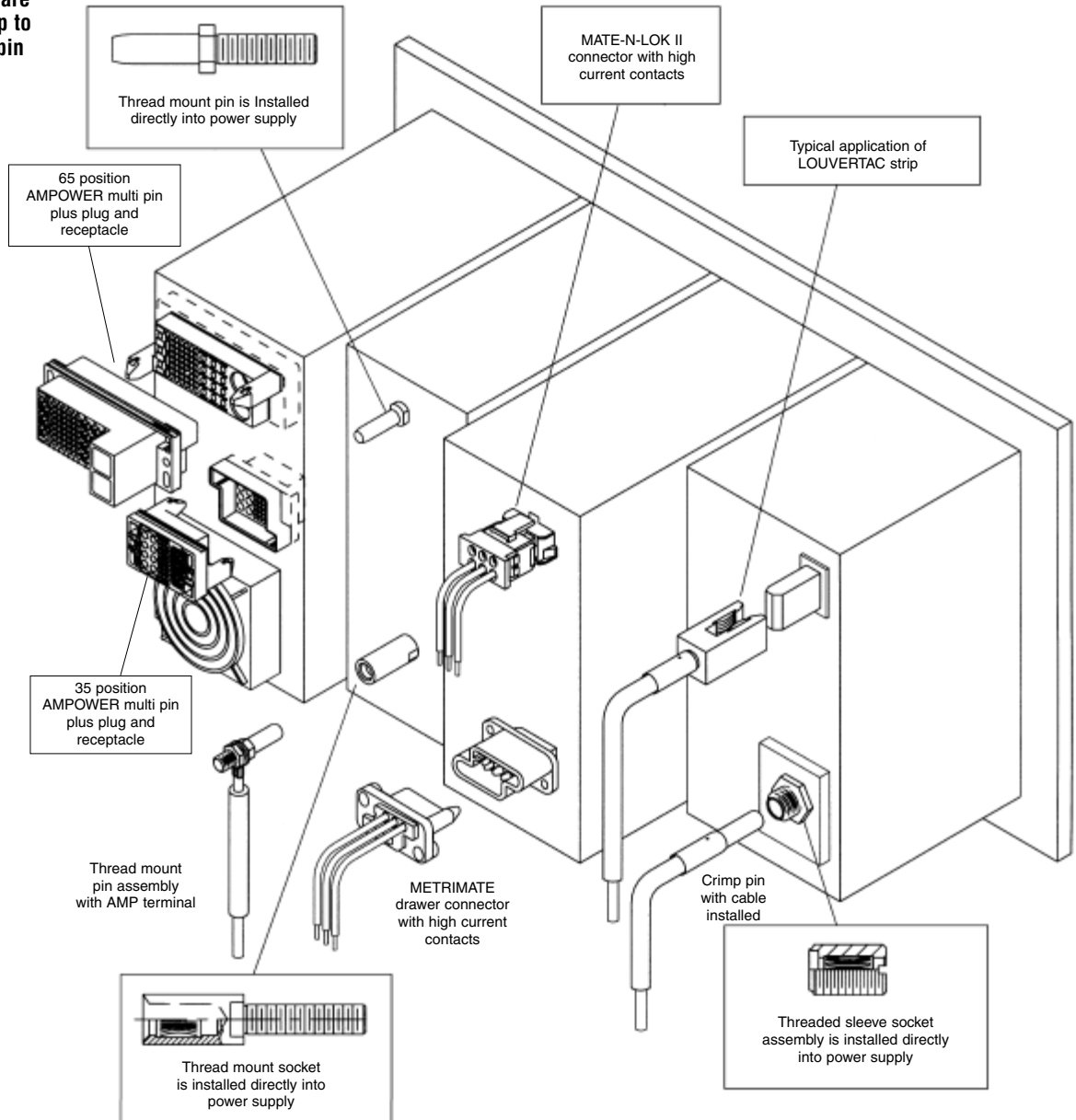

For more information, request Catalog 64141.

AMP Power Series Connectors

Product Facts

- Single-pole and 2-pole (battery) quick connect/disconnect connectors
- Eight Series, based on approximate current-carrying capability:
 - Series 15/30/45 (Single-Pole)
 - Series 50 (2-Pole Battery)
 - Series 50 Finger Probe Resistant (FPR)
 - Series 75 (Single-Pole)
 - Series 120 (Single- and 2-Pole)
 - Series 175 (2-Pole Battery)
 - Series 180 (Single-Pole)
 - Series 350 (2-Pole Battery)
- Voltage rating: 600 V AC/DC
- Color-coded housings, UL 94V-0
- Hermaphroditic (genderless) housings reduce inventory
- Modular, single-pole housings are stackable in four directions
- Polarity (+ and -) molded into 2-pole housings promotes proper wiring
- Mechanical keys help prevent two different color-coded housings from mating
- Stainless steel retaining springs secure contacts in housings
- Stamped and formed, open barrel contacts (6-20 AWG) on reels for automatic and semiautomatic machine termination
- Loose piece, cold-headed contacts (6 AWG – 300 MCM) for manual and hydraulic hand tools; reducing bushings accommodate smaller wire sizes
- Compatible with industry standard crimp tooling from PICO Corporation (<http://www.picotools.com>)
- Connectors intermateable with similar connectors from other manufacturers



- Series 15/30/45, single-pole connectors designed to meet Amateur Radio Emergency Service (ARES)/Radio Amateur Civil Emergency Service (RACES) Standard Power Connector requirements
- Accessories available for mounting, vibration protection, and strain relief
- Component Recognized by Underwriters Laboratories Inc. to US and Canadian Standards, File No. E28476



AMP Power Series Connectors provide a durable, quick connect/disconnect means to transmit “power” levels of current and voltage (15-275 A, 600 V AC/DC).

This product family is primarily comprised of single-pole and 2-pole (battery) connector housings, crimp snap-in contacts, and accessories. Housings are offered in various colors. Two-pole housings have different polarization configurations; with the exception of black housings, each color identifies a different keying configuration. In general, only like color housings will mate. Contacts are either cold-headed or stamped and formed, depending upon the connector Series.

AMP Power Series Connectors are divided into eight Series, based on approximate current-carrying capability.

Applications

AC/DC Power Supplies and Charging Systems, Rechargeable Batteries, Material Handling Equipment (e.g. forklift trucks), Electric Vehicles (e.g., golf carts, sweepers, wheelchairs), Office Furniture/Panels, Amateur Emergency Radios, and Industrial Equipment.

AMP Power Series Connectors (Continued)

Technical Documents

Various technical documents are available for your use:

Product Specifications describe technical performance characteristics and verification tests. They are intended for the Design, Component and Quality Engineer.

108-1349	AMPINNERGY WTB Connectors
108-1373	AMPINNERGY WTW Connectors
108-2104	AMP Power Series 50 Connectors
108-2149	AMP Power Series 15 Connectors
108-2150	AMP Power Series 30 Connectors
108-2151	AMP Power Series 45 Connectors
108-2152	AMP Power Series 75 Connectors
108-2153	AMP Power Series 120 Connectors
108-2154	AMP Power Series 175 Connectors
108-2155	AMP Power Series 180 Connectors
108-2156	AMP Power Series 350 Connectors

Application Specifications describe requirements for using the product in its intended application and/or crimping information. They are intended for the Packaging and Design Engineer and the Machine Setup Person.

114-6044	AMPINNERGY WTB Connectors
114-6051	AMPINNERGY WTW Connectors
114-13071	AMP Power Series 50 (Double-Pole) and 75 (Single Pole) Connector Assemblies
114-13107	AMP Power Series 120 (Single- and Double-Pole) Connector Assemblies
114-13118	AMP Power Series 175 (Double-Pole) and 180 (Single-Pole) Connector Assemblies
114-13119	AMP Power Series 350 (Double-Pole) Connector Assemblies
114-13127	AMP Power Series 15, 30 and 45 (Single-Pole) Connector Assemblies
114-13149	AMP Power Series 180 (Single-Pole) Connector Assemblies

Instruction Sheets provide instructions for assembling or applying the product. They are intended for the Manufacturing Assembler or Operator.

408-3198	Inspection of AMPINNERGY System Power Contacts
408-3236	Installation of AMPINNERGY WTB Connectors
408-3277	AMPINNERGY Wire-To-Wire Stackable Connectors
408-8636	AMP Power Series 50 Connector Assemblies
408-8868	AMP Power Series 175 and 350 Connector Assemblies with Cable Clamp Kits
408-4557	Heavy Duty Cable Cutter Hand Tool 605743-1
408-4559	Heavy Duty Cable Cutter Hand Tool 605744-1
408-4561	Heavy Duty Cable Cutter Hand Tool 6057469-1
408-8540	Crimp Tool 1526955-1
408-9688	Cable Stripper/Slitter Tool 606700-1
408-9816	Handling of Reeled Products

Test Summary

502-1136	50/75 Product Evaluation
502-1160	15/30/45 Product Evaluation
502-1166	120 Product Evaluation
502-1167	120 Competitive Evaluation
502-1172	AMP Power Series 175/180 Product Evaluation
502-1173	AMP Power Series 350 Product Evaluation

Customer Manual

409-5128	AMP-O-LECTRIC Model K Terminator Machine 1-471273-2
-----------------	---

DOMINO Series Connectors

Hot-Plug High Current Modular Power Connectors

Key Features

- Modular construction
- Blind mating
- High current CROWN BAND contacts
- Logic/Signal
- Locking system
- Uses ELCON Drawer contacts

Typical Applications

- Power Supplies
- Telecommunications
- Automatic Test Equipment
- Computer Hardware
- Process Control
- Uninterruptible Power Systems
- All DOMINO Products in this section are RoHS compliant

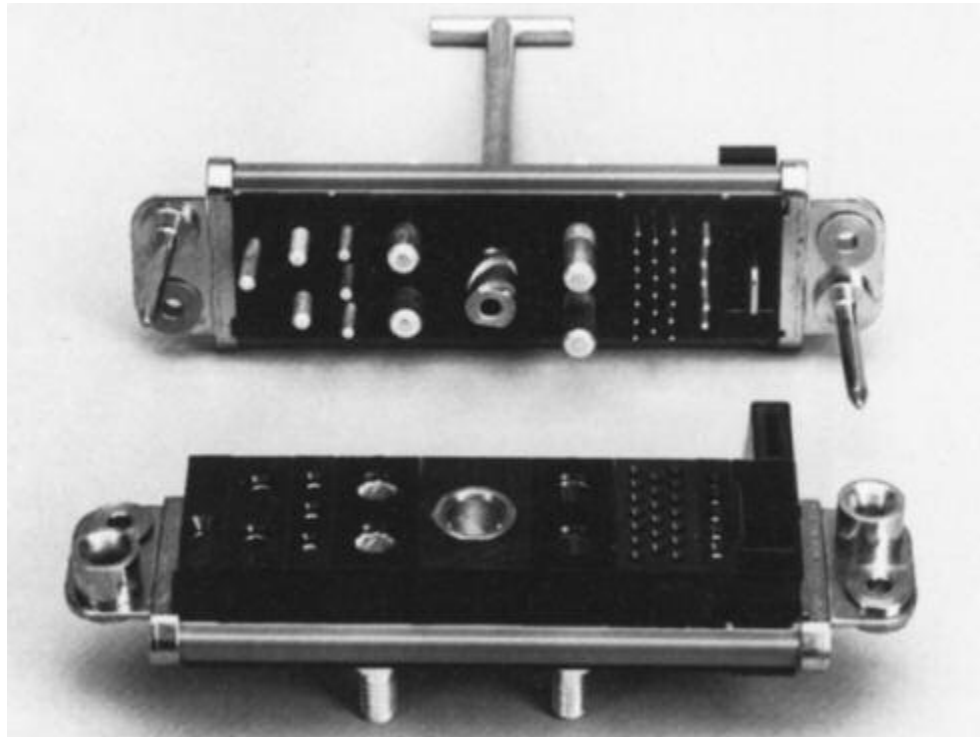

The ELCON DOMINO Connector System is a modular high-current connector system consisting of interchangeable modules which can provide AC, DC, logic and signal, float mounting, and pin sequencing. All DOMINO modules incorporate CROWN BAND technologies, tried and tested under the most arduous conditions. The high current capabilities virtually eliminate the need for bussing or splitting current, with resulting space savings and economies.

The DOMINO connector system allows the user to configure a connector specific to an application, from off-the-shelf components. It can be purchased as separate modules and assembled by the user, but is more generally ordered as a

connector assembly using an assembly part number which Tyco Electronics assigns to a specific configuration. Consult Tyco Electronics for assistance in laying out a new connector. If required, DOMINO connector assembly is simple: once the locking rails are cut to size, the only tool required is a Phillips screwdriver for tightening the end-caps.

Most DOMINO contacts are the same as used in ELCON Drawer connectors. Modules A through E and R are sold as housings with retention clips; the contacts are ordered separately. See page 79 for available contact options and plating information, page 66 for tooling. Modules K, L, and M are sold pre-loaded with contacts. DOMINO assemblies are shipped complete with contacts.

The DOMINO system is ideal for use with hot-pluggable power supplies of the type employed for load-sharing and/or redundant power for computer systems. Current interruption capability is standard in the L module and an available option in the A module.

The CROWN BAND contact is a small louvered cylindrical receptacle of Beryllium Copper. Manufactured on progressive dies to allow consistent, even insertion and withdrawal forces, its design ensures maximum surface contact area for minimum voltage drop and minimum heat generation. CROWN BAND contacts also provide excellent shock and vibration resistance.

DOMINO Series Connectors (Continued)

A Modules — 3 x #12 Power Contacts, Hot-Plug option available

Note: Supplied without contacts. Crimp insertable/removable, PCB insertable/non-removable

Specifications: Contact rating 35 Amps UL, 20 Amps CSA, 250V; Hot-plug 35 Amps UL, 30 Amps CSA, 120 V ac, 50 cycles; Fully loaded module nominal forces: insertion 9.2 lbs, extraction 5.5 lbs (Hot-plug insertion 11.5 lbs, extraction 6.4 lbs)

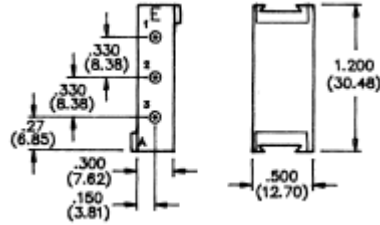

Pin Housing
(without contacts)
Part Number 1648461-1

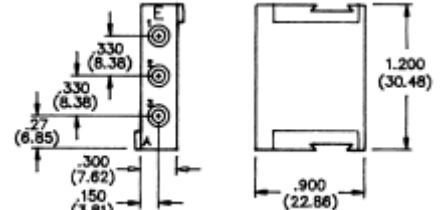

Socket Housing
(without contacts)
Part Number 1648466-1

B Modules — 2 x #8 Power Contacts

Note: Supplied without contacts. Crimp insertable/removable, PCB insertable/non-removable

Specifications: Contact rating 75 Amps UL, 40 Amps CSA, 250V; Fully loaded module nominal forces: insertion 6.7 lbs, extraction 3.9 lbs

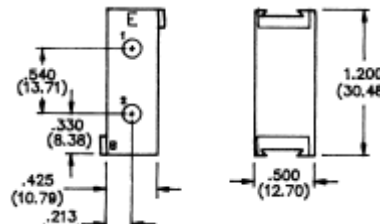

Pin Housing
(without contacts)
Part Number 1648462-1

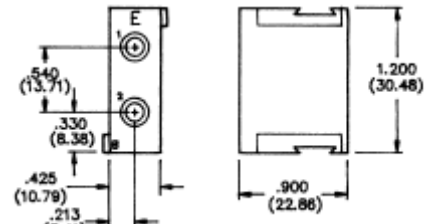

Socket Housing
(without contacts)
Part Number 1648467-1

C Modules — 20 x #20 Signal Contacts

Note: Supplied without contacts. Crimp insertable/removable, PCB insertable/non-removable

Specifications: Contact rating 5 Amps UL, 4 Amps CSA, 125V; Fully loaded module nominal forces: insertion 2.4 lbs, extraction 2.6 lbs

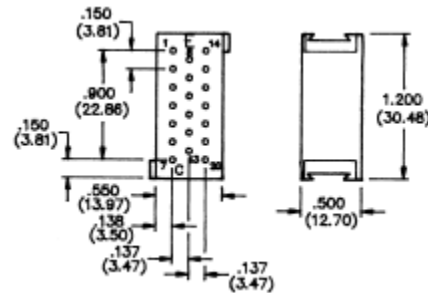

Pin Housing
(without contacts)
Part Number 1648463-1

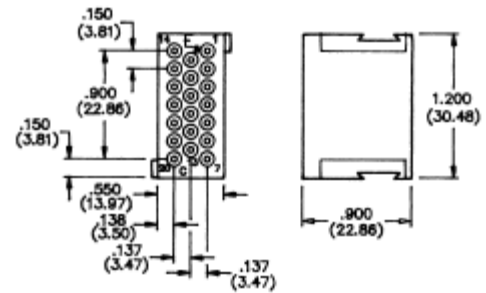

Socket Housing
(without contacts)
Part Number 1648468-1

D Module — 5 x #16 Power Contacts

Note: Supplied without contacts. Crimp insertable/removable, PCB insertable/non-removable

Specifications: Contact rating 15 Amps UL, 10 Amps CSA, 125V; Fully loaded module nominal forces: insertion 18.6 lbs, extraction 13.0 lbs

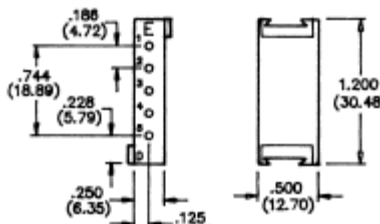

Pin Housing
(without contacts)
Part Number 1648464-1

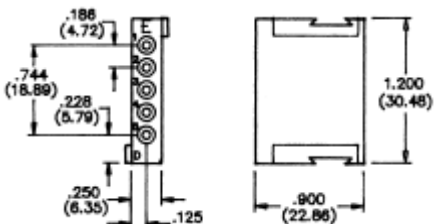

Socket Housing
(without contacts)
Part Number 1648469-1

Note: All part numbers are RoHS compliant.

DOMINO Series Connectors (Continued)

E Modules — 14 x #16 Power Contacts

Note: Supplied without contacts. Crimp insertable/removable, PCB insertable/non-removable

Specifications: Contact rating 15 Amps UL, 10 Amps CSA, 125V; Fully loaded module nominal forces: insertion 43.1 lbs, extraction 33.7 lbs

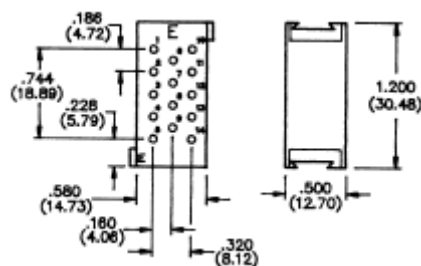

Pin Housing
(without contacts)
Part Number 1648465-1

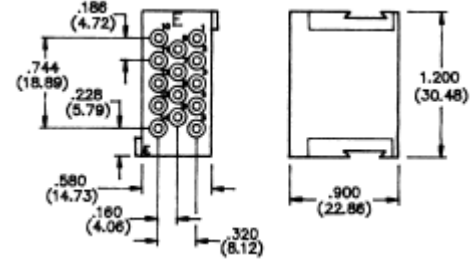

Socket Housing
(without contacts)
Part Number 1648470-1

G Modules - Non-electrical Guide Module

Note: May be turned through 180 in the horizontal plane

Specifications: Guide pin type 303 Stainless Steel, passivated

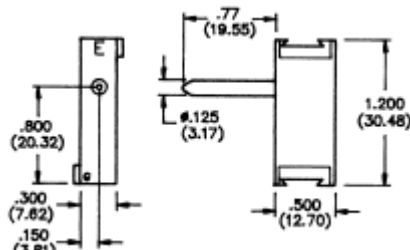

Guide Pin
Part Number 1648505-1

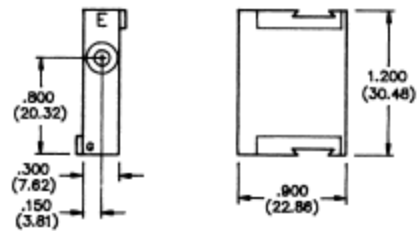

Guide Socket
Part Number 1648473-1

J Modules — Jackscrew Locking Module

Note: Select socket side to match desired orientation of T-handle in locked position

Specifications: Corrosion resistant Steel

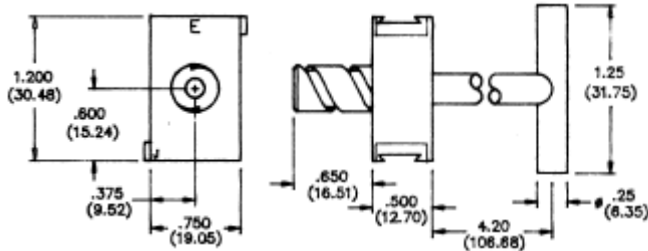

Pin Side
4.20" T-Handle Part
Number 6648482-1

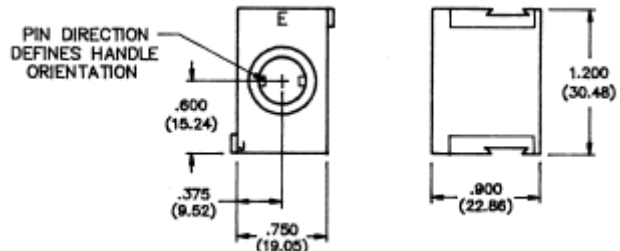

Parallel Socket Side
Part Number 6650679-1

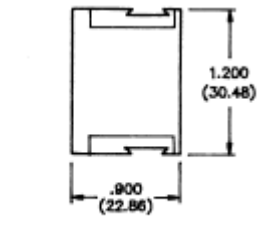

Perpendicular Socket Side
Part Number 6650680-1

K Modules — Electrically Active Ground/Guide Module

Note: May be turned through 180 in the horizontal plane. Use Crimp Tool PN 1766453-1

Specifications: Contact rating 40 Amps UL, 15 Amps CSA, 250V; Fully loaded module nominal forces: insertion 3.0 lbs, extraction 1.3 lbs

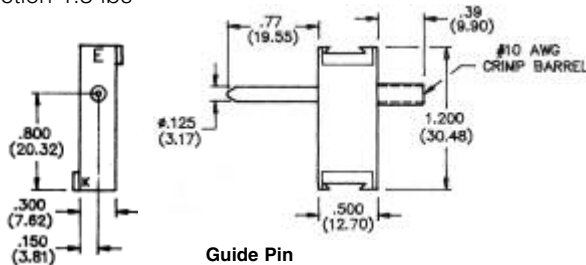

Guide Pin
10 AWG Crimp
Part Number 6648508-1

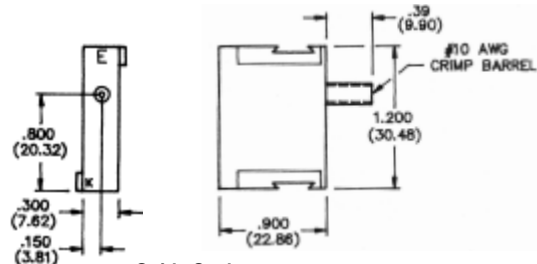

Guide Socket
10 AWG Crimp
Part Number 6648476-1

Note: All part numbers are RoHS compliant.

Cable Mounted Products

DOMINO Series Connectors (Continued)

L Modules — Hot-Plug Flat Blade Contact, Crown Socket

Note: Pin and socket modules may be assembled within either pin or socket side connector for reverse polarization. Standard blade length, dim A = .400"; premate blade length, dim A = .525" Use Crimp Tool PN 1766453-1

Specifications: Agency approved for 50 Cycles of current interruption; contact rating 30 Amps UL/CSA, 250V and 55 Amps UL, 30 Amps CSA, 72 V dc; Fully loaded module nominal forces: insertion 4.2 lbs, extraction 3.7 lbs

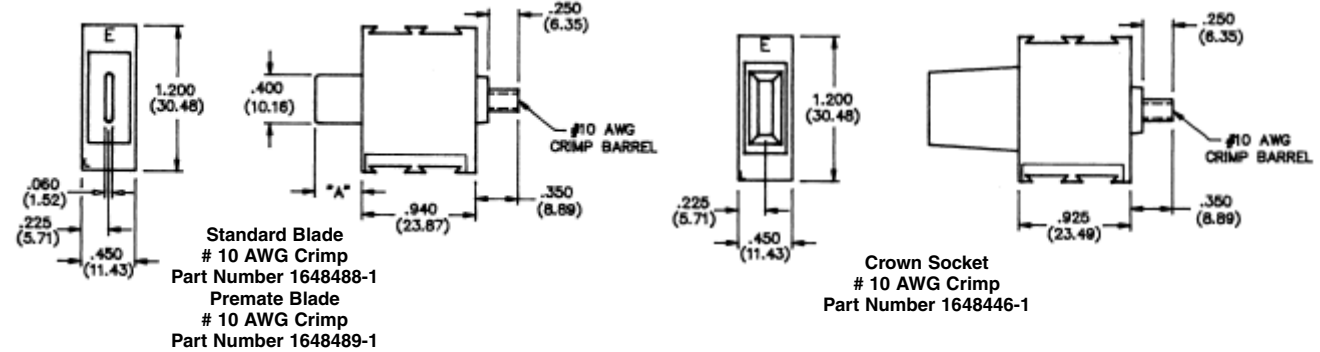

M Modules — Pre-installed Dual In-Line Crown Pin & Socket

Specifications: Contact rating 125 Amps UL/CSA, 250V; Fully loaded module nominal forces: insertion 14.9 lbs, extraction 9.8 lbs

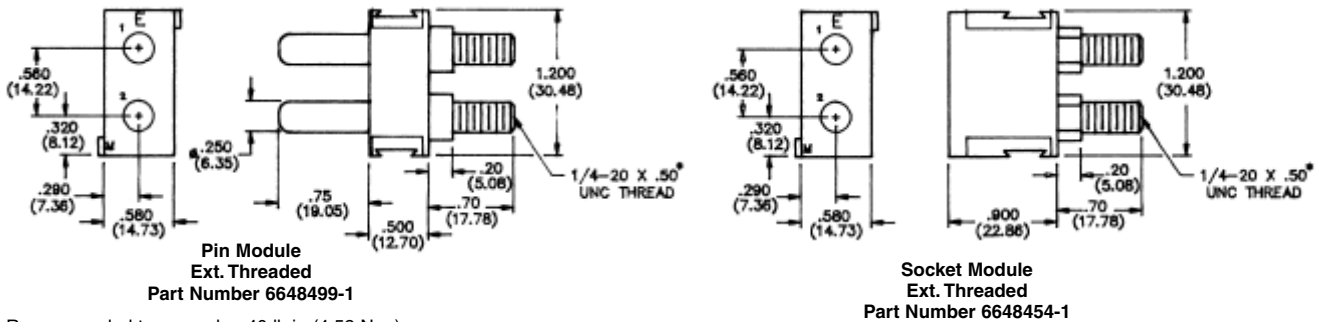

Recommended torque value 40 lb.in (4.52 N.m)

R Modules — 2 x 1/4" Power Contacts

Note: Supplied without contacts; available contacts: Crimp insertable/removable, Ext. Threaded insertable/non-removable, consult Tyco Electronics for contact part numbers and available Double Crown option

Specifications: Contact rating 150 Amps UL, 110 Amps CSA, 250V; Fully loaded module nominal forces: insertion 9.4 lbs, extraction 6.0 lbs

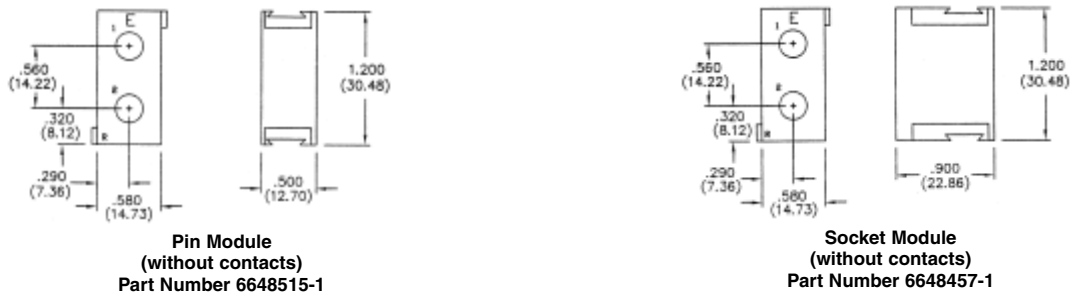

Spacer Module — Non-electrical

Note: any module may be ordered without contacts for use as spacers; consult factory for options and part numbers.

Note: All part numbers are RoHS compliant.

DOMINO Series Connectors (Continued)

DOMINO Assembly
Mounting Accessories

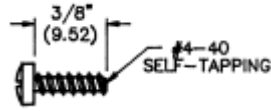

Screw Part Number 1766829-1, Steel

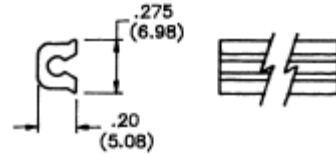

Locking Rail Part Number 1648990-1,
Aluminum alloy, gold anodized finish, 36" length.
Requires cutting to size.

Locking Rail (at 1' interval)
Part Number 1650469-1

End Caps — Zinc die cast, CRS hardware, trivalent chromate finish

End caps secure the modules when screwed into the locking rails providing rigid assembly and a means of mounting assembly to frames, bulkheads, etc. Float mount styles correct for misalignment during mating. Any end cap may be used to mount either pin or socket sides.

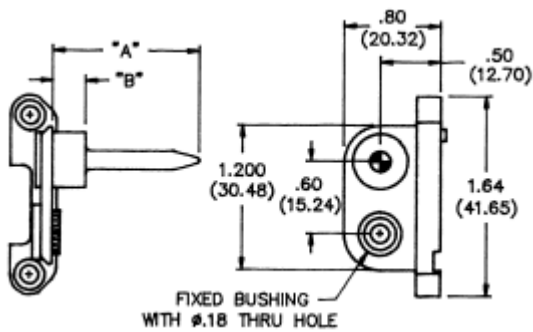

Fixed Mount, Guide Pin
Part Number 6648259-1
A = 1.22 (30.98), B = .275 (6.98)

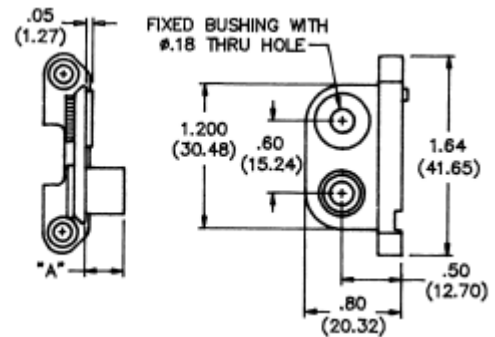

Fixed Mount, Guide Socket
Part Number 6648263-1
A = .175 (4.44)

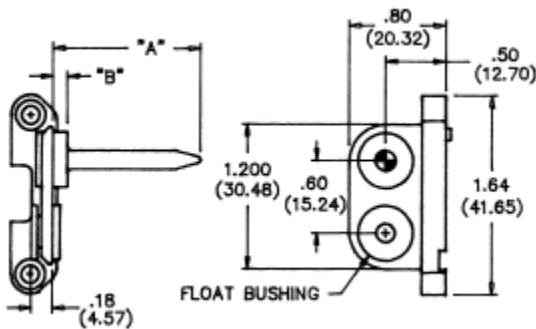

Float Mount, Guide Pin
Part Number 6648251-1
Standard
A = 1.22 (30.98), B = .275 (6.98)
Part Number 6648253-1
L-Module
A = 1.62 (41.14), B = .125 (3.17)

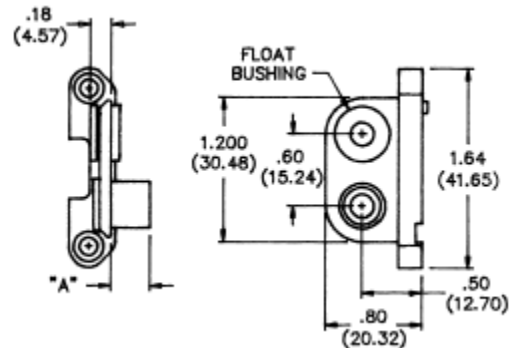

Float Mount, Guide Socket
Part Number 6648252-1
Standard
A = .175 (4.44)
Part Number 6648254-1
L-Module
A = .325 (8.25)

Note: All part numbers are RoHS compliant.

DOMINO Series Connectors (Continued)

DOMINO Module Assembly Process

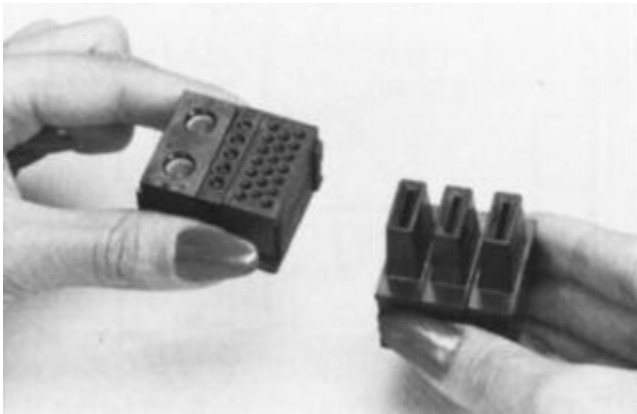

1. Align modules in desired order.

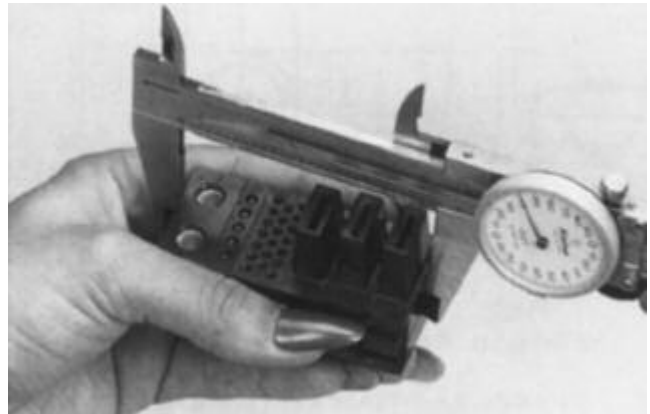

2. Measure length of assembly, and add .100" (2.54mm) to determine overall rail length. Cut rails to length.

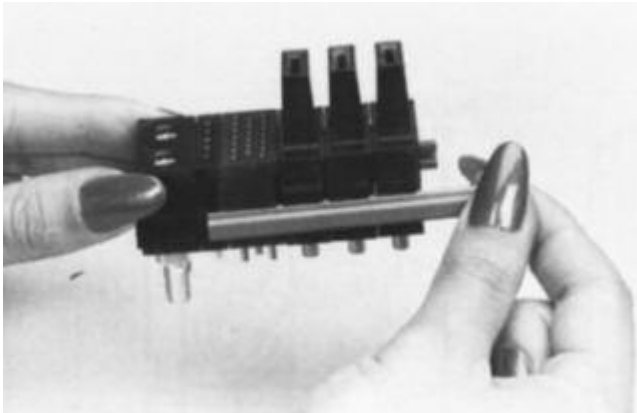

3. Slide locking rails into position on both sides of module assembly via the molded rail tracks.



4. Position end caps over locking rail ends and secure using Phillips head screws.

HTS Power Connectors

Product Facts

- Heavy-duty, rectangular, multiple-position, pin and socket connectors
- Current rating: 10-500 A
- Voltage rating: 1-1.4 kV
- Number of contact positions: 1 through 216
- Connectors are designated by four components: base and hood, and male and female inserts
- Contact inserts provide for three types of wire termination: screw (no crimp tool required), crimp (higher pin count), and cage clamp (fastest)
- HE Series inserts (screw terminated) are the most popular
- Bases provide environmental (IP 55, 65 and 68) and electrical protection (NEMA 4 and 4X)
- Bases share an industry standard panel cutout and mounting hole pattern
- Hoods offer top, side, or angled cable entry. Hoods are tapped to accommodate metric or PG fittings
- Automated tooling matched to contact
- DIN/VDE, UL, CSA and SEV approved



HTS Power Connectors are heavy-duty, rectangular, multiple-position, pin and socket connectors. They are commonly referred to as "Rectangular" or "European Metal Shell" connectors.

HTS Connectors are designated by four components: base and hood, and male and female inserts. The designation is driven by electrical specifications; pin count and current rating define the inserts needed. From 1 to 216 contact positions are available. Current ratings range from 10-500 A.

The appropriate housing size (1-12) to accommodate selected inserts is then defined. Housing selection criteria include: base mounting style, latch type, hood cable entry location, and hood gland size. The most popular housing sizes are: Shell Size 1 (3 or 4 positions), Shell Size 3 (6 positions), Shell Size 6 (16 positions), Shell Size 8 (24 positions), and Shell Size 5 (25 positions).

HTS Connectors have many applications: Industrial Machinery (automotive, plastics, semiconductors, material handling, packaging and printing), Railroad and Mass Transit (A/C and brake subsystems, power transformers, door systems, switches and signals, and drive motor enclosures).

For more information, request Catalog 1308980.

RAPID LOCK Quick Connect/Disconnect Bus Bar Connectors

Product Facts

- Replaces power lugs
- Locking feature “snaps” each contact to mating pin
- Up to 250 Amps per contact
- CROWN BAND Connector Technology provides low contact resistance

Typical Applications

- Power Distribution Systems



The RAPID LOCK connector is a single-pole, quick connect/disconnect replacement for lug connections, used in bus bar and back-plane power distribution applications. RAPID LOCK connectors allow a reliable and safe connection, as well as better serviceability, than bolt-fitted lugs. The cable mounted sockets have a right angle configuration, and feature an insulator cap that provides the retention mechanism on the pin. The pin contacts can be attached to a bus bar by screw or swage, and to a backplane by press fit and backup screw.

Secure Power Distribution

By replacing power lugs fitted using nuts and bolts, the RAPID LOCK connector offers an extremely secure interconnect mechanism that totally frees the power distribution system from the risk of loose connections, which can cause arcing.

Safety Locking Feature

A locking feature is provided on the pins for protection against accidental unlatching of the cable. Although connection of the cable is easily performed by hand, disconnection requires a simple tool to provide the leverage needed to overcome the locking feature.

Improved Ease of Service

Service in the field becomes very easy with RAPID LOCK connectors because there are no nuts and washers to lose in the equipment. The RAPID LOCK connector is available with red or black color insulators.

CROWN BAND Technology

The RAPID LOCK connector enjoys all the benefits of the ELCON CROWN BAND technology, providing a stable connection with excellent mechanical and electrical performance with ratings up to 300 Amps depending on wire gauge and application.

Note: All RAPID LOCK Products in this section are RoHS compliant.

RAPID LOCK Quick Connect/Disconnect Bus Bar Connectors (Continued)

RAPID LOCK Connectors
Ordering Information

Size	Crimp Size	Part Numbers				
		Socket			Pin	
		Black	Red	Blue	Swage	Screw
#8	AWG#8	6648228-1	6648228-2	N/A	—	—
	AWG#12	6648237-1	6648237-2	N/A	6648221-1	N/A
	AWG#6	1766484-1	1766484-2	N/A	—	—
#4	AWG#8	6648235-1	6648235-2	N/A	—	—
	AWG#4	6648236-1	6648236-2	N/A	6648222-1	6648224-1
	AWG#6	6648239-1	6648239-2	N/A	—	—
#2	AWG#0	6648234-1	6648234-2	N/A	6648223-1	6648226-1
	AWG#2	6648238-1	6648238-2	N/A	6648223-1	6648226-1
12mm	95 Sq. mm	N/A	1857547-1	1857547-2	1857523-3	N/A

Size	Insulation Boot			
	Black	Red	Grey	Blue
#4/#8	1651003-1	1651003-2	1651003-3	1651003-4
#2	1766600-1	1766600-2	1766600-3	1766600-4

Product Specifications

Materials

Insulator	Thermoplastic, UL 94V-0 flammability rated
Socket Contact Body	Copper alloy, plated Silver over nickel
CROWN BAND	Beryllium Copper, plated Gold (30 micro inches minimum) over nickel
Pin Contact	Copper alloy, plated Silver over nickel

Electrical

Current Rating @ 30°C T-rise	Size 8 — 50 Amps on 8 AWG wire Size 4 — 115 Amps on 4 AWG wire Size 2 — 145 Amps on 2 AWG wire Size 12mm — 250 Amps on 95mm ² wire
Contact Resistance	Size 8 — 0.5mΩ Size 4 — 0.15 mΩ Size 2 — 0.12 mΩ
Voltage Drop	See graphs

Mechanical

Removal Tool	Part Number 1857376-1
--------------	-----------------------

Test Data

Shown below is current versus temperature rise of the five different available socket sizes.

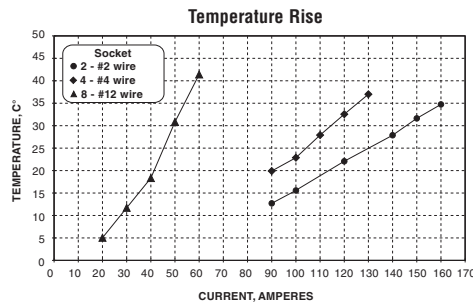

Shown below is current versus voltage drop performance of the five different available socket sizes.

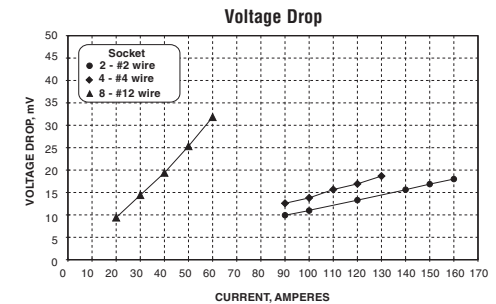

Note: All part numbers are RoHS compliant.

RAPID LOCK Quick Connect Sockets and Pins

Cable Mounted Sockets

RAPID LOCK sockets are crimped to AWG #4, #6 or #8 size cable depending on the application requirements. Envelope dimensions are common except for the crimp barrel diameter.

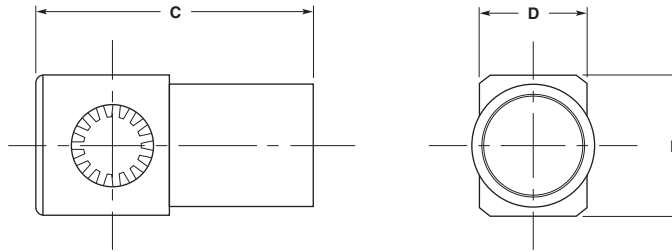

Pin Contacts

RAPID LOCK pin contacts are offered in either swage or screw & washer mounting options for .125" (3.18 mm) or 3mm (.118") thick PCB or bus bars. Consult Tyco Electronics Customer Service for other bus bar and backplane thicknesses and designs.

Part Number	Size	Dimensions			Cable AWG
		C	D	E	
6648228-X	#8	1.080	.500	.500	8
6648237-X		27.43	12.70	12.70	12
1766484-X					6
6648235-X	#4	1.08	.500	.500	8
6648236-X		27.43	12.70	12.70	4
6648239-X					6
6648234-X	#2	1.280	.490	.640	0
6648238-X		32.51	12.45	16.26	2
1857178-X					1/0
1857547-X	12.0mm	1.920	.930	.930	3/0
		48.70	23.70	23.70	

Note: X refers to available color variants.

Press Fit Pin Contacts

Attach Type	Pin Size	Mounts to
Screw and Washer	#4	Bus bar/Backplane
		Bus bar
Swage	#4	Bus bar

Note: All part numbers include attachment hardware (screw, washer, etc.)

Swage Mount Pin

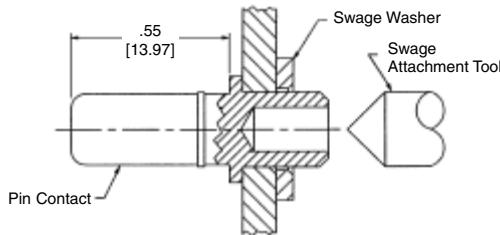

Part Number	Size	Dimensions	
		A	B
6648221-1	#8	.142	.550
		3.81	13.97
6648222-1	#4	.250	.550
		6.35	13.97
6648223-1	#2	.375	.550
		9.53	13.97
1857523-3*	12.0mm	.470	.850
		12.00	21.70

*Requires washer Part Number 1857513-2

Screw Mount Pin

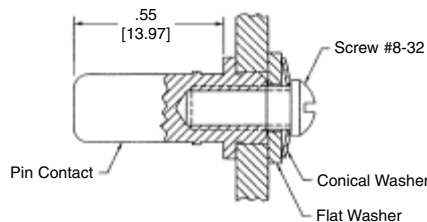

Part Number	Size	Dimensions	
		A	B
6648224-1	#4	.250	.550
		6.35	13.97
6648226-1	#2	.375	.550
		9.53	13.97

Note: All part numbers are RoHS compliant.

Custom RAPID LOCK Connector Products

In addition to the flexibility offered with standard RAPID LOCK connector products, the basic technology and standard components may also be packaged to suit specific customer needs. Some examples of custom packages are given below.

Cable Mounted Products

Snap-Lock Sockets

Discrete pins are generally offered with or without a locking feature. A locking feature for a discrete socket is provided by a special two piece molding (94 V-0). This enables the socket to snap over a locking pin, and provides a 5 lb withdrawal force. The molding will also lock into a panel or holder of .125 (3.18) thickness.



Part Number 1643279-1 Black

Part Number 1643279-2 Red

Part Number 1643279-3 Blue

Press-Fit Discrete Contacts

Pins and sockets of the type shown are designed for press-fit to board or bus bar, and allow plug-in removal of a variety of board mount components, discrete contacts, and flat-pack power supplies. Each socket contains a CROWN BAND contact, ensuring high current capacity and minimum loss, and accommodating misalignment.



Note: All part numbers are RoHS compliant.

AMP Power Taps

Product Facts

- **ACTION PIN** contacts eliminate soldering
- Provides high current, separable connection to pc board traces
- Wire-to-board connection using common terminals
- All metal-to-metal assembly for long-term integrity
- Standard DIP outlines (7.62 x 2.54 [.300 x .100]), 10 positions, and 6.35 x 3.18 [.250 x .125], 6 and 10 positions, plus high current versions on 10.16 x 5.08 [.400 x .200] footprint in 4 and 6 positions, 7.62 x 2.54 [.300 x .100] in 8 positions, and both 2 and 3 position in-line 2.54 [.100] tab taps
- Low resistance interface
- Internally threaded tap to secure screw to terminal
- Anti-rotational embossments hold wire and terminal in place
- Standard Power Taps rated at 2.5 amps per pin — 6 position 15 amps, 10 position 25 amps current carrying capability
- High Current Power Taps rated at up to 5 amps per pin — 2 position 10 amps, 3 position 15 amps, 4 and 6 position 20 amps and 8 position 40 amps
- 30 amp inverse sex Power Tap

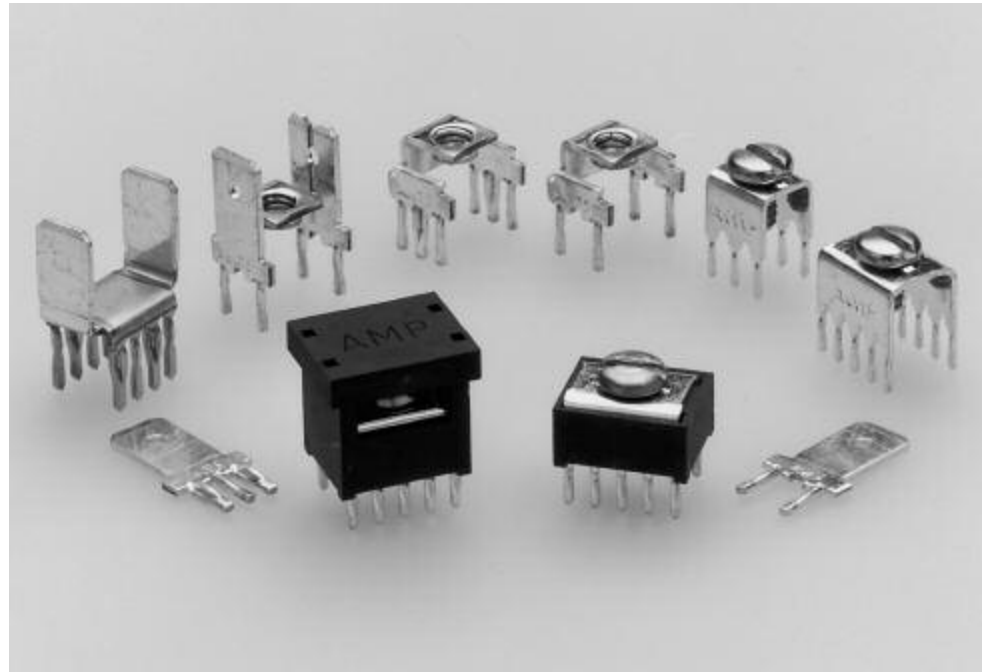

AMP Power Taps are designed for the growing need for power to printed circuit board applications required in today's electronic industry. The taps provide a high current, separable connection to a pc board. Pin configuration is of the standard DIP outline with 7.62 x 2.54 [.300 x .100] or 6.35 x 3.18 [.250 x .125] for the Standard versions, plus 10.16 x 5.08 [.400 x .200], 7.62 x 2.54 [.300 x .100] and in-line spacing for the High Current versions.

ACTION PIN contacts provide a low resistance interface with tin-plated through holes in the pc board, thereby eliminating the need for soldering.

The variety of available power taps allow for various installation schemes. The Uninsulated Tap and Low Profile Tap can be used in bus bar pattern. The High Profile and Low Profile Taps offer insulation protection from other components. The High Current versions provide a greater power

density option with current ratings from 10 amps on the 2 position in-line 6.35 [.250] tab tap up to 40 amps on the 8 position dual 6.35 [.250] tab tap.

All AMP Power Tap configurations are easily inserted into the pc board with a simple Tyco Electronics or customer supplied tool.

AMP Power Taps (Continued)

Material and Finish

Connector Body and Lid — Nylon, 105°C 94V-0 rated

Contact — Copper alloy, bright tin-lead or tin plated

Screw — Plated steel

Electrical and Mechanical Characteristics

Resistance — 2 milliohms, max. (stud hole to ACTION PIN contact)

Insertion Force — 40 lbs. [177.9N], max. per pin

Retention Force — 7 lbs. [31.1N], min. per pin

Technical Documents

Product Specification — 108-11030 Tap, Power Distribution

Application Specification — 114-11000 Tap, Power Distribution

Handbook — 5697 Guide to Application of ACTION PIN Connectors

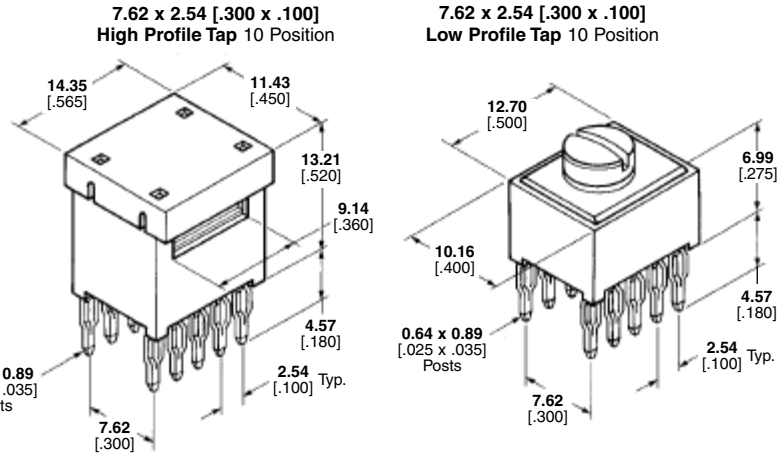
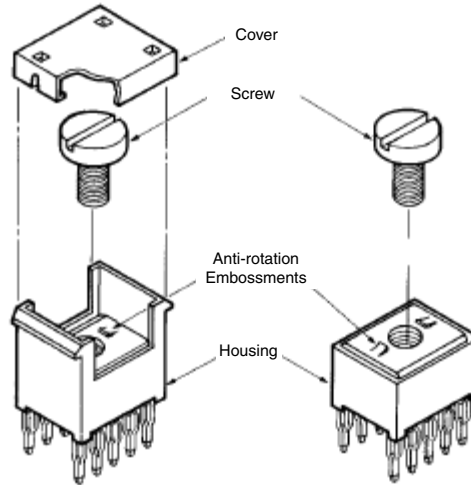

Tap Version	PCB Thickness	Description	Screw Hole Size	Part Number	
				Tin Lead	Tin
High Profile	1.57-3.18 .062-.125	Housing and Contact Assembled With Screw ^{1,2}	6-32	55557-4 ♦	5055557-4
Low Profile	1.57-3.18 .062-.125	Housing and Contact Assembled With Screw ²	6-32	55556-4 ♦	5055556-4
Low Profile	1.57-3.18 .062-.125	Housing and Contact Assembled With Screw ^{2,3}	6-32	55673-2 ♦	5055673-2
Low Profile	1.57-3.18 .062-.125	Housing and Contact Assembled Without Screw	M4	55556-9 ♦	5055556-9

¹Cover not Assembled

²Screw not Assembled

³No Anti-rotational Embossments

For Standard Threaded Taps Only

Recommended PC Board Layout

Drilled Hole Diameter — 1.15±0.03 [.0453±.001]

After Plating 0.94-1.09 [.037-.043]

After Reflow — 0.91-1.09 [.036-.043]

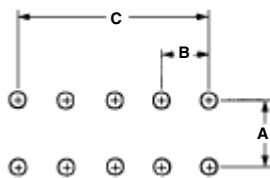

Size	Dimensions		
	A	B	C
7.62 x 2.54 .300 x .100 10 Position	7.62 .300	2.54 .100	10.16 .400
6.35 x 3.18 .250 x .125 6 Position	6.35 .250	3.18 .125	6.35 .250
6.35 x 3.18 250 x .125 10 Position	6.35 .250	3.18 .125	12.7 .500

Note: Part Numbers are RoHS compliant except: ♦ Indicates non-RoHS compliant.

AMP Power Taps (Continued)

Material and Finish

Contact—Copper alloy, post plated bright tin-lead or tin plated
Screw—Stainless steel, passivated

Electrical and Mechanical Characteristics

Resistance — 2 milliohms, max. (stud hole to ACTION PIN contact)
Insertion Force — 40 lbs. [177.9N] max. per pin
Retention Force — 7 lbs. [31.1N] min. per pin

For Recommended PC Board Layout, see page 132.

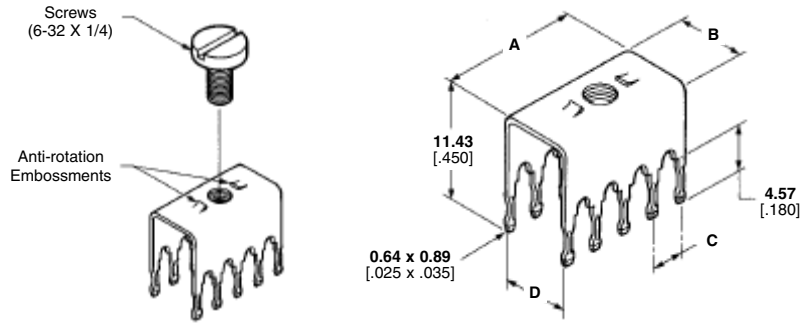

Size	PCB Thickness	Dimensions				Description	Screw Size	Part Number	
		A	B	C	D			Tin Lead	Tin
7.62 x 2.54 .300 x .100 10 Position	1.57-3.18 .062-.125	11.18 .440	8.26 .325	2.54 .100	7.62 .300	Without Screw	6-32	55558-3	5055558-3
						With Screw	6-32	55558-4	5055558-4
6.35 x 3.18 .250 x .125 6 Position	1.57-3.18 .062-.125	8.13 .320	6.99 .275	3.18 .125	6.35 .250	Without Screw	6-32	55323-5	5055323-5
						With Screw	6-32	55323-9	5055323-9
6.35 x 3.18 .250 x .125 10 Position	1.57-3.18 .062-.125	14.48 .570	6.99 .275	3.18 .125	6.35 .250	Without Screw	6-32	55232-6	5055323-6
						With Screw	6-32	1-55323-0	1-5055323-0

High Current* Power Taps

*Up to 20 amps

Material and Finish

Contact — Phosphor bronze, tin-lead or tin plated
Screw — Stainless steel, passivated
Washer — Stainless steel

Electrical and Mechanical Characteristics

Current Rating — 20 amperes max.
Insertion Force — 40 lbs. [180N] max. per pin
Retention Force — 7 lbs. [30N] min. per pin

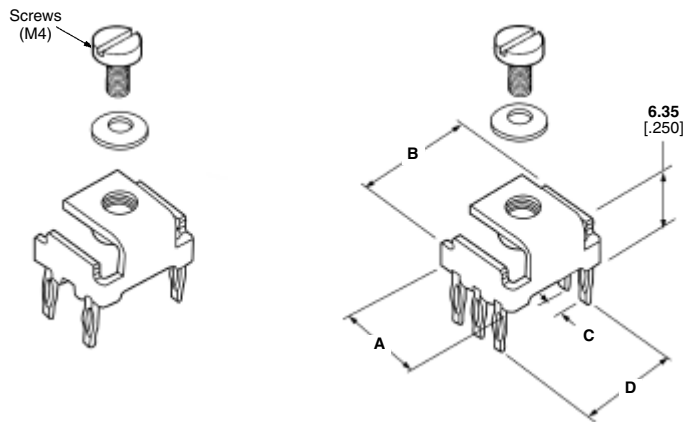

Size	PCB Thickness	Dimensions				Description	Part Number	
		A	B	C	D		Tin Lead	Tin
4 Position	1.57-3.18 .062-.125	9.09 .358	10.95 .431	5.08 .200	10.16 .400	With Screw, Washer	213815-1 ♦	5213815-1 ♦
						Without Screw	216906-11	—
6 Position	1.57-3.18 .062-.125	9.09 .358	10.95 .431	2.54 .100	10.16 .400	With Screw, Washer	213816-1 ♦	5213816-1 ♦
						Without Screw	216907-11	—

1No Anti-rotation Embossments featured on High Current Taps. Therefore, if application requires product supplied without washer and screw, use of lock-washers with a high surface contact area are strongly recommended.

For High Current and FASTON Taps

Use with Hand Press **677430-1**

Recommended PC Board Layout

Drilled Hole Diameter—
1.60±0.03 [.063±.001]
Cu Thickness—
0.03-0.08 [.001-.003]
SnPb Thickness—
0.004 min. [.0002 min.]

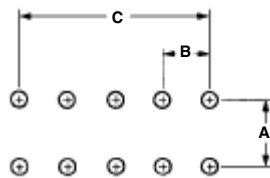

Finished Hole—
1.36-1.54 [.054-.061]
After Reflow—
1.36-1.54 [.054-.061]

Type	A	B	C
4 Position	10.16 .400	5.08 .200	5.08 .200
6 Position	10.16 .400	2.54 .100	5.08 .200
I	—	5.08 .200	5.08 .200
II	—	2.54 .100	5.08 .200
III	10.16 .400	5.08 .200	5.08 .200
IV	7.62 .300	2.54 .100	7.62 .300

Note: Part Numbers are RoHS compliant except: ♦ Indicates non-RoHS compliant.

AMP Power Taps (Continued)

*Up to 5 amps per pin

Mating Connectors
FASTON Receptacles

Material and Finish

Contact — Phosphor bronze, post plated tin-lead or tin plated

Screw — Stainless steel, passivated

Washer — Stainless steel

Electrical and Mechanical Characteristics

Current Rating — 5 amps max. per pin

Insertion Force — 40 lbs. [180N] max. per pin

For Recommended PC Board Layout, see page 133.

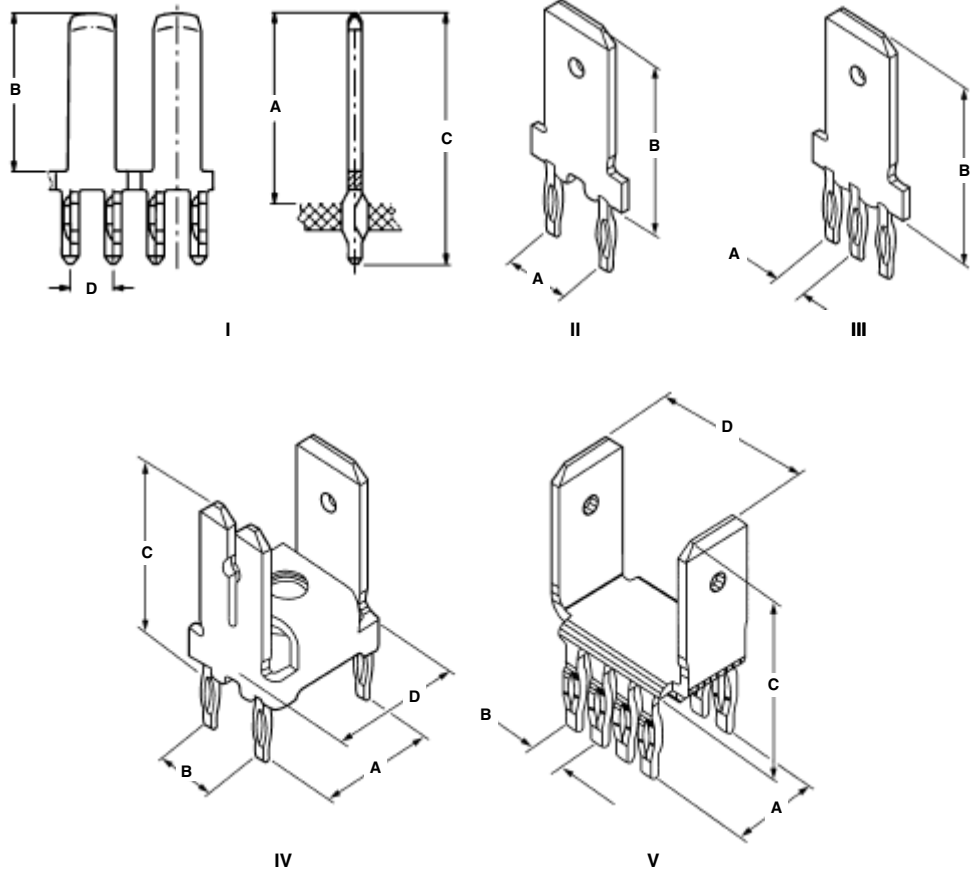

Style	PCB Thickness	Dimensions				Description	Part Number	Receptacle Mating
		A	B	C	D			
I	1.39 x 1.54 .055 x .061	13.50 .531	10.75 .423	18.50 .728	2.54 .100	2.8 x 0.80 .110 x .031 Tab	338429-2 ♦	Positive Lock
II	1.57 x 3.18 .062 x .125	5.08 .200	13.49 .531	—	—	6.35 x 0.81 .250 x .032 Tab	216926-1	Positive Lock
III	1.57 x 3.18 .062 x .125	2.54 .100	13.49 .531	—	—	6.35 x 0.81 .250 x .032 Tab	216843-1	Positive Lock
IV	1.57 x 3.18 .062 x .125	10.16 .400	5.08 .200	13.49 .531	10.95 .431	1-6.35 x 0.81 .250 x .032 Tab	216905-1 ¹	Positive Lock
						2-2.79 x 0.81 .110 x .032 Tab		
V	3.18 .125	7.62 .300	2.54 .100	12.32 .485	12.70 .500	2-6.35 x 0.81 .250 x .032 Tab	5167892-32 ♦	FASTON Rcpt.
						With Hole	167892-6 ²	Positive Lock

¹No Anti-rotation Embossments featured on High Current Taps. Therefore, if application requires product supplied without washer and screw, use of lock-washers with a high surface contact area are strongly recommended.

²Phosphor Bronze, post plated matte tin

Note: Part Numbers are RoHS compliant except: ♦ Indicates non-RoHS compliant.

AMP Power Taps (Continued)

Product Facts

- Excellent for power distribution
- For board-to-board and board-to-bus applications
- LOUVERTAC high current contact used in receptacle
- ACTION PIN compliant pcb tails for high surface area contact with plated through hole
- Receptacle fits onto standard DIP 7.62 x 2.54 [.300 x .100] footprint
- Press-fit receptacle needs simple “flat-rock” tooling to install
- Accommodates board thickness from 1.37 to 3.18 [.054 to .125]
- Insulated body rated 105°C 94 V-0
- Blindmate capability (tolerance: ± 3.18 [± .125] in X and Y axes)
- Perpendicular board stacking
- Silver or Gold plated
- UL recognition at 35 Amps

Material and Finish

Housing — Thermoplastic black
Body — Zinc Alloy
Contact — Bronze Alloy
Pin — Brass Alloy

Technical Documents

Product Specification — 108-1624 and 108-1624-1
Application Specification — 114-11000 Tap, Power Distribution

Compatible with Z-PACK 2mm HM product family.

Vertical Receptacle

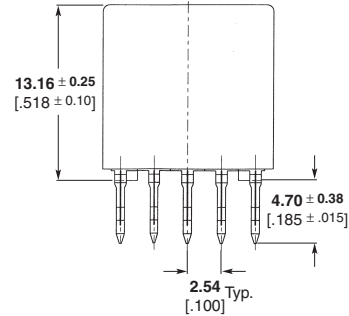
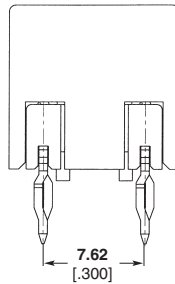
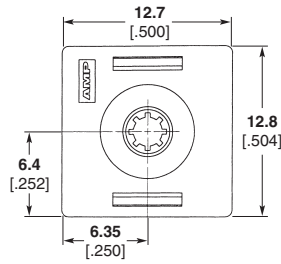

Recommended PC Board Layout

Right Angle Pin

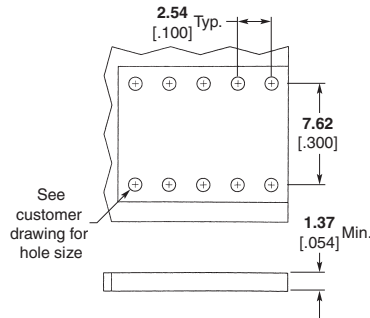
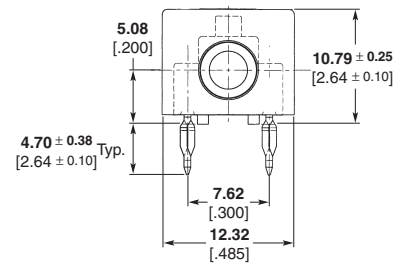
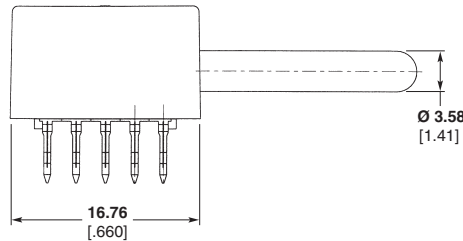

Recommended PC Board Layout

Description	Plating	Part Number
Right Angle Pin	Gold	796137-2
Vertical Receptacle	Gold	796138-2

Note: Part Numbers are RoHS compliant except: ♦ Indicates non-RoHS compliant.

AMP Power Taps (Continued)

**Application Tooling/
PCB Layout**

**For Standard Threaded
Taps Only**

**Recommended PC Board
Layout**

Drilled Hole Diameter—
.0453±.001 [1.15±0.03]

After Plating

.037-.043 [0.94-1.09]

After Reflow—

.036-.043 [0.91-1.09]

**Installation and Extraction
Tooling**

Impact Insertion Tool Number

313102-1

(Insertion Tip No. 58133-1 required)

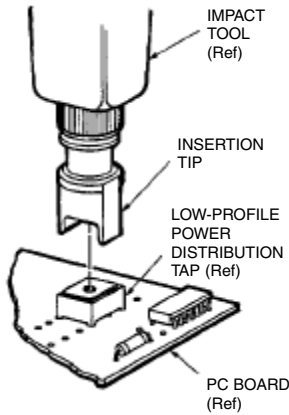
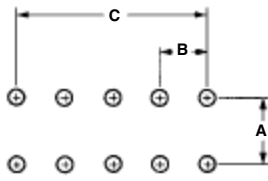

Extraction Tool Number 68380-1

Size	Dimensions		
	A	B	C
.300 x .100 7.62 x 2.54 10 Position	.300 7.62	.100 2.54	.400 10.16
.250 x .125 6.35 x 3.18 6 Position	.250 6.35	.125 3.18	.250 6.35
250 x .125 6.35 x 3.18 10 Position	.250 6.35	.125 3.18	.500 12.7

**For High Current and
FASTON Taps**

Use with Hand Press **677430-1**

**Recommended PC Board
Layout**

Drilled Hole Diameter—
.063±.001 [1.60±0.03]

Cu Thickness—

.001-.003 [0.03-0.08]

SnPb Thickness—

.0002 min.[0.004 min.]

Finished Hole—

.055-.061 [1.39-1.54]

After Reflow—

.054-.061 [1.36-1.54]

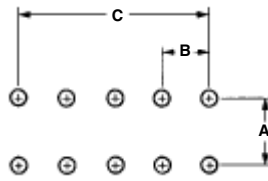

Type	A	B	C
4 Position	.400 10.16	.200 5.08	.200 5.08
6 Position	.400 10.16	.100 2.54	.200 5.08
I	—	.200 5.08	.200 5.08
II	—	.100 2.54	.200 5.08
III	.400 10.16	.200 5.08	.200 5.08
IV	.300 7.62	.100 2.54	.300 7.62

Installation Tooling

Type	Part Number	Upper Tool	Lower Tool
High Current 4 & 6 Positions	216906-1 216907-1	432848-1	433600-2 or 432130-2
High Current Style I, II	216926-1 216843-1	432845-1	433600-2 or 432130-2
High Current Style III	216905-1	432847-1	433600-2 or 432130-2
High Current Style IV	5167892-3 167892-6	432849-1	433600-2 or 432130-2

Note: Part Numbers are RoHS compliant except: ♦ Indicates non-RoHS compliant.