

EF Series



UL Recognized
CSA Certified
VDE Approved*



EF Series

This rugged international series of RFI filters incorporates the special IEC power line connector. They are UL recognized, CSA certified, and VDE approved.

Electrically the EF international series are general purpose filters effectively providing RFI control of line-to-ground noise. The design is compact and meets the very low leakage current requirements of VDE portable equipment as well as (120 Volt) UL544 non-patient medical equipment. Models with F suffix have .250" terminals on load side; EF4 and EF8 have wire leads.

Model 10EF1FC additionally incorporates a separate ground-circuit inductor to isolate the equipment chassis from power line ground at RF frequencies.

*15EF1F
UL, CSA 15 Amps/250 VAC
VDE 10 Amps/250 VAC

Electrical Schematics

EF & EF-F Models

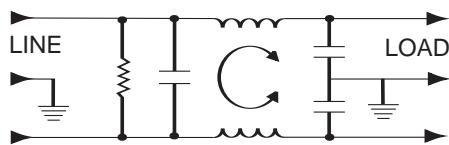

EF1FC Model

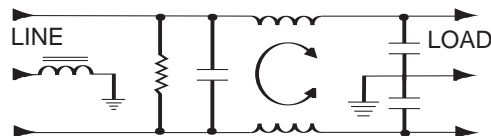

Resistor location for reference only.

Specifications

Maximum leakage current, each line-to-ground
 @ 120 VAC 60 Hz: .21 mA
 @ 250 VAC 50 Hz: .36 mA

Hipot rating (one minute):
 line-to-ground 2250 VDC
 line-to-line 1450 VDC

Operating frequency: 50/60 Hz

Rated voltage (max.): 250 VAC

Minimum insertion loss in dB:

Line-to-ground in 50 ohm circuit

Current Rating	Frequency-MHz					
	.15	.5	1	5	10	30
EF1F, EF2F						
1A	22	35	40	46	50	49
3A	15	25	30	45	50	54
6A	9	20	25	41	45	50
10A	8	15	20	34	39	44
15A	-	6	12	20	25	25
EF4, EF8						
1A	22	35	40	46	50	49
3A	15	25	30	45	50	54
6A	9	20	25	41	45	47
EF1FC						
10A	8	15	20	34	39	44

Line Cord

Line Cord No. GA400:

7 1/2 foot, 3-conductor line cord to mate with EF series.

EF Series

Case Styles

EF1F & EF1FC

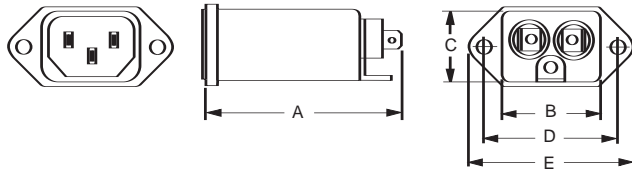

EF2F

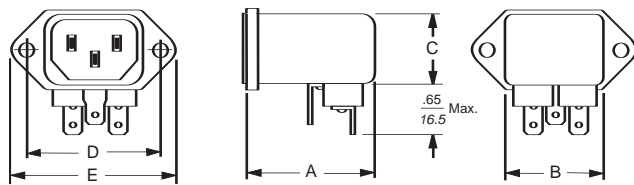

Typical dimensions:
Terminals: .250 [6.35] (3)
Slot: .07 x .16 [1.8 x 4.7]

Holes: .07 [1.8] Dia.(2)

EF4

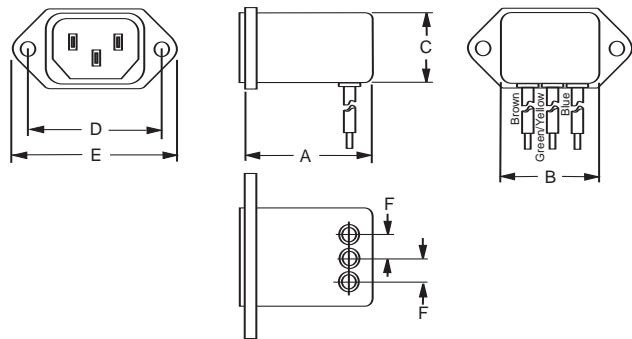

EF8

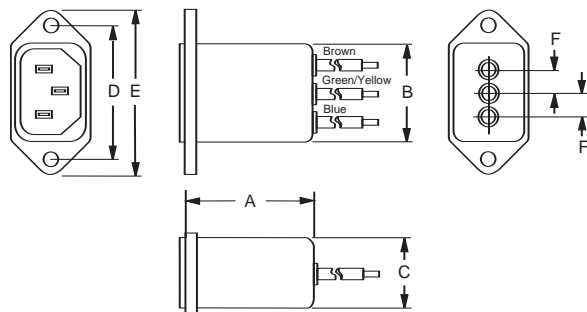

Typical dimensions:
Wire leads 4.0 [107.6] Min. 18 AWG Mounting Holes: .132 [3.35] Dia.(2)

Case Dimensions

Part No.	A (max)	B (max)	C (max)	D $\frac{+.015}{-.38}$ (max)	E (max)	F (ref)
1EF1F,	2.20	1.19	0.81	1.575	1.98	—
3EF1F	55.9	30.2	20.6	40.01	50.3	—
1EF2F,	1.55	1.19	0.85	1.575	1.98	—
3EF2F	39.4	30.2	21.6	40.01	50.3	—
1EF4,	1.55	1.19	0.85	1.575	1.98	.295
3EF4	39.4	30.2	21.6	40.01	50.3	7.5
1EF8,	1.55	1.19	0.81	1.575	1.98	.295
3EF8	39.4	30.2	20.6	40.01	50.3	7.5
6EF1F	2.20	1.19	0.81	1.575	1.98	—
	55.9	30.2	20.6	40.01	50.3	—
6EF2F	1.55	1.19	0.85	1.575	1.98	—
	39.4	30.2	21.6	40.01	50.3	—
6EF4	1.55	1.19	0.85	1.575	1.98	.295
	39.4	30.2	21.6	40.01	50.3	7.5
6EF8	1.55	1.19	0.81	1.575	1.98	.295
	39.4	30.2	20.6	40.01	50.3	7.5
10EF1F	2.62	1.19	0.81	1.575	1.98	—
	66.5	30.2	20.6	40.01	50.3	—
10EF1FC	2.62	1.19	0.81	1.575	1.98	—
	66.5	30.2	20.6	40.01	50.3	—
15EF1F*	2.62	1.19	0.81	1.575	1.98	—
	66.5	30.2	20.6	40.01	50.3	—

Part Numbers

1EF1F	6EF1F
1EF2F	6EF2F
1EF4	6EF4
1EF8	6EF8
3EF1F	10EF1F
3EF2F	10EF1FC
3EF4	15EF1F*
3EF8	

Line Cord No. GA400

Insulating Boot No. FA601

*15EF1F
UL, CSA — 15 Amps/250 VAC
VDE — 10 Amps/250 VAC

Recommended Panel Cutouts

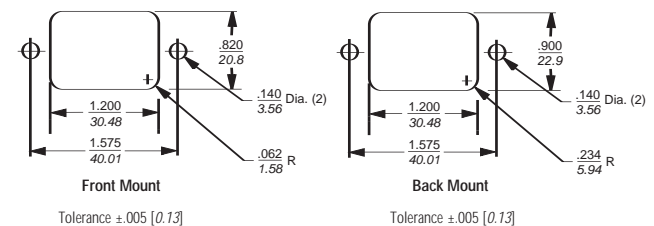

Note 1: EF1F, EF1FC and EF8 allow front or back mounting.
Note 2: EF2F and EF4 allow back mounting only.