

THIS DRAWING IS UNPUBLISHED.
 DIFFUSION RESTREINTE AMP
 © COPYRIGHT BY TYCO ELECTRONICS CORPORATION.
 ALL RIGHTS RESERVED.
 TOUS DROITS RESERVES.

LOC	DIST	REVISIONS					
F	7	P	LTR REV	DESCRIPTION MODIFICATIONS	DATE	DWN DESS.	APVD APP.
		A		MODIFICATION INTERFACE PC	27-MAI-98	JLQ	-
		B		SUPPRESSION /-2 AND /-4	11-SEP-98	JLQ	-
		C		CONTACTS COTE CI A 2.9	16-DEC-98	JLQ	-
		D		CODING PIN ON PCB FOR -3	10-JAN-01	JLQ	-
		E		ADD NEWS PNS: 953363-2/-4	29-AUG-06	NT.N	J.L
		F		ADD NEW PN 1-953363-3	22-NOV-06	NT.N	J.L

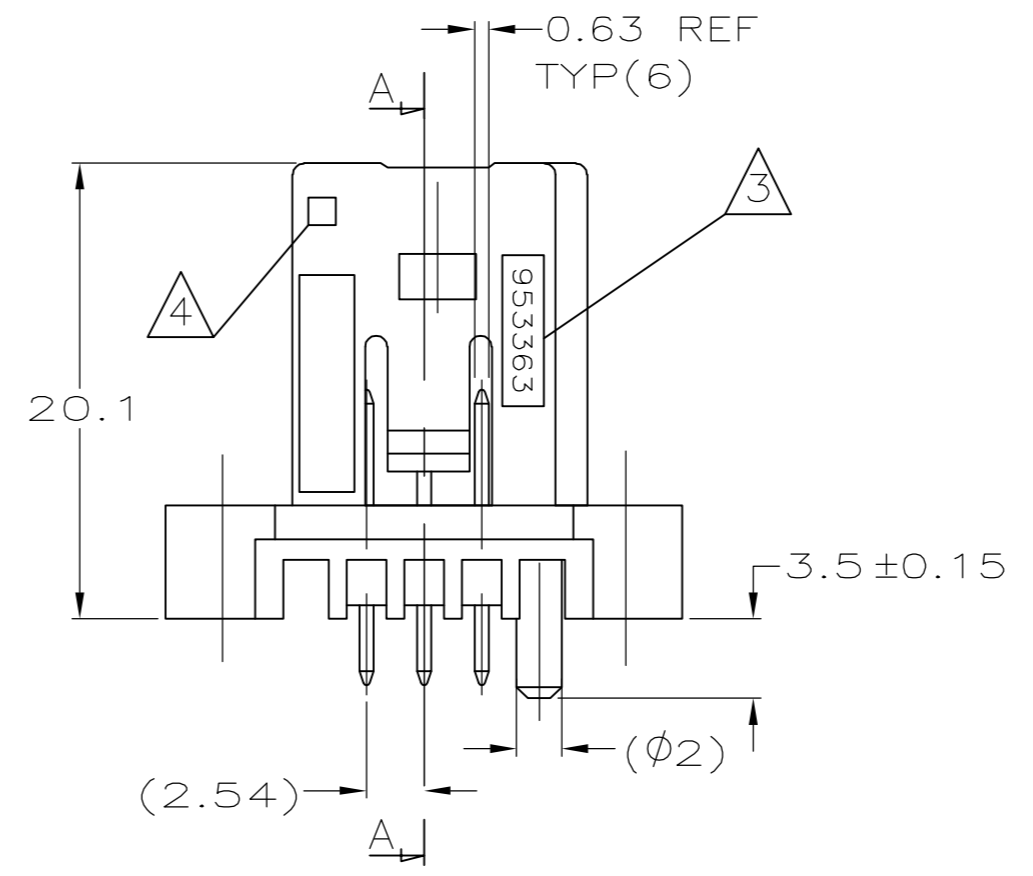

DETROMPAGES / CODINGS
 IMPLANTATION CI / PCB DETAILS
 VUE DE DESSUS / VIEW FROM TOP

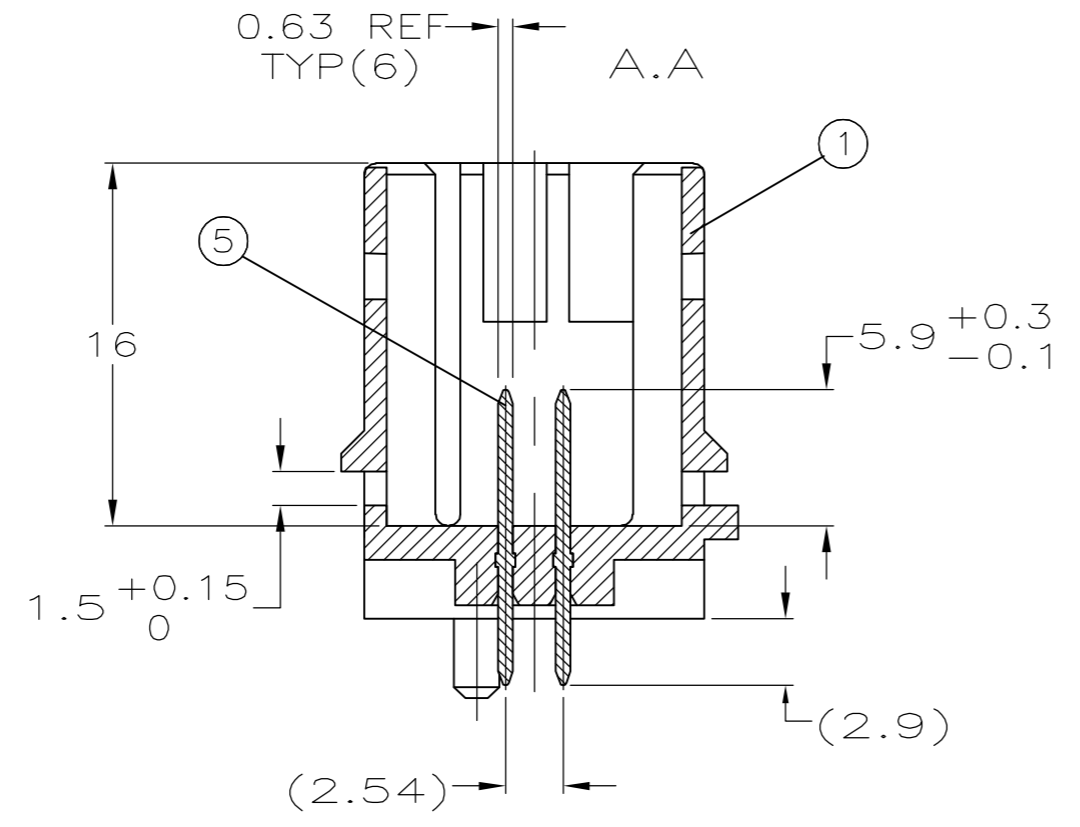
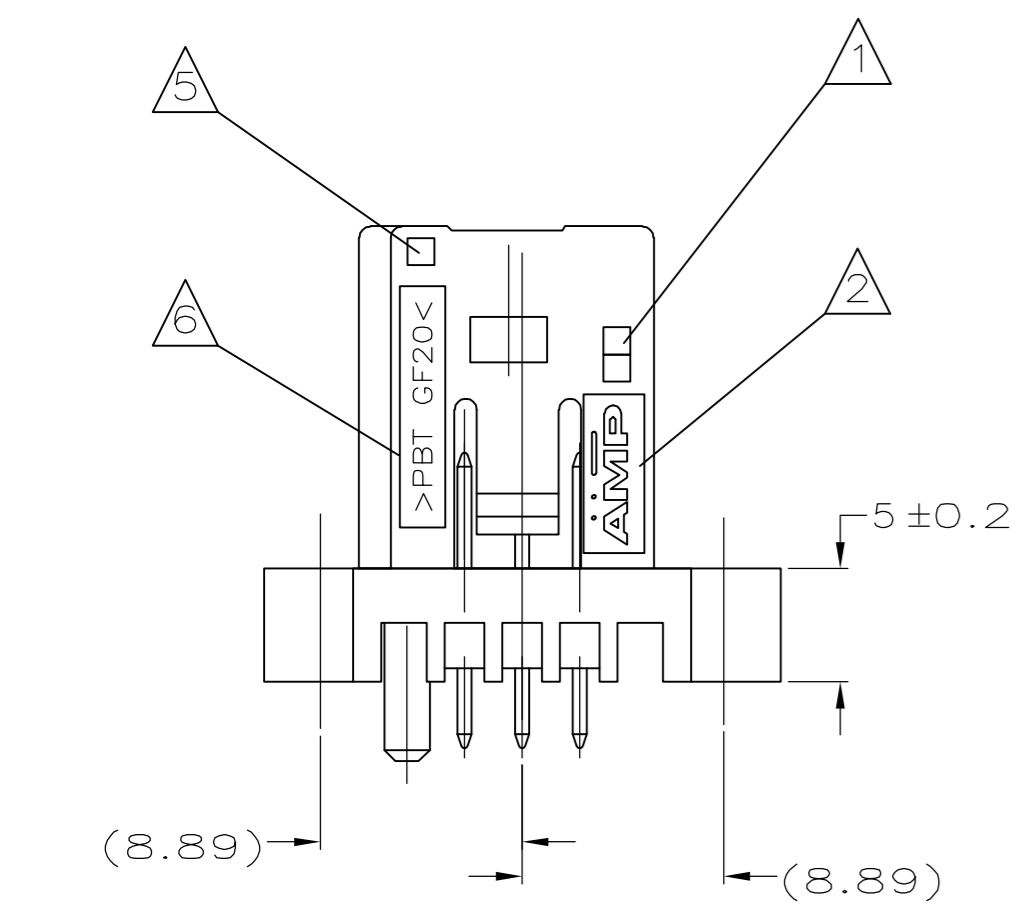
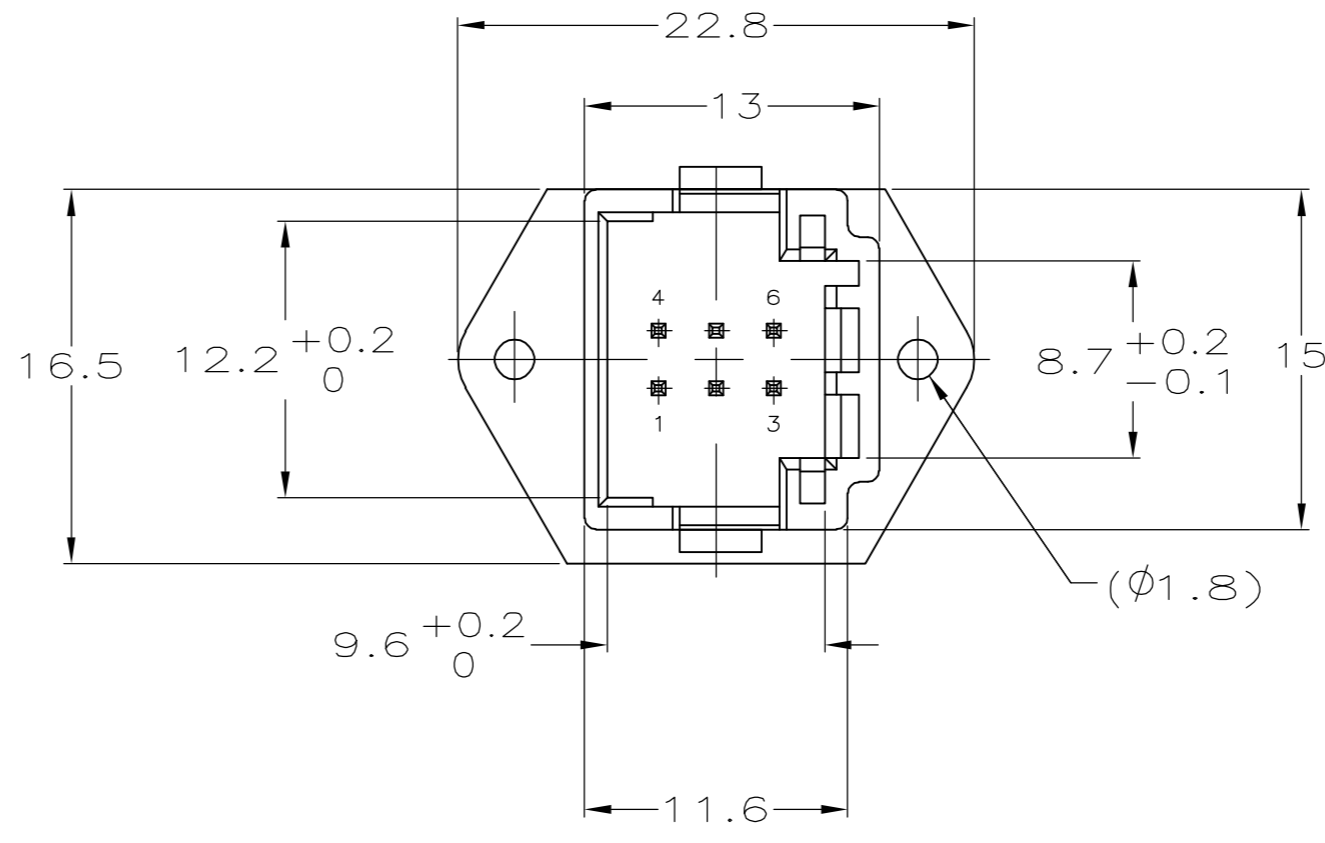
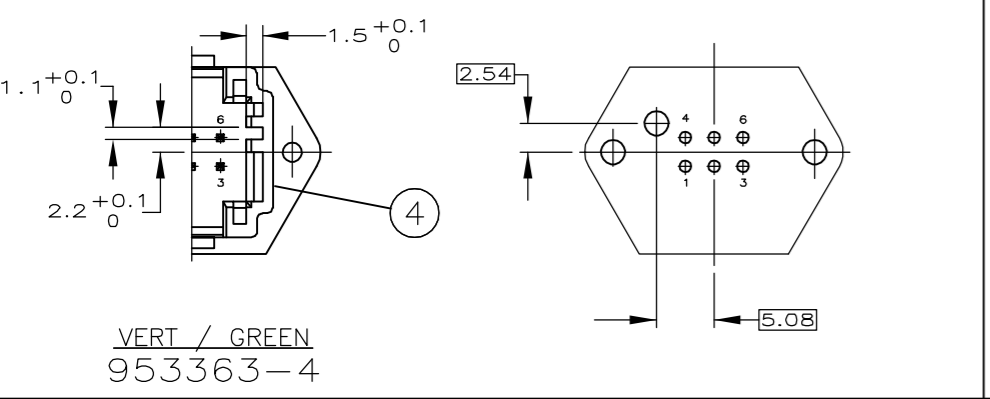
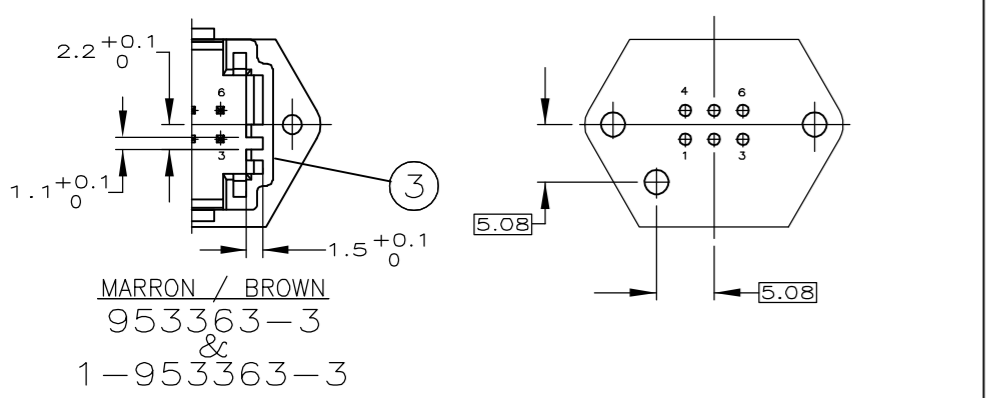
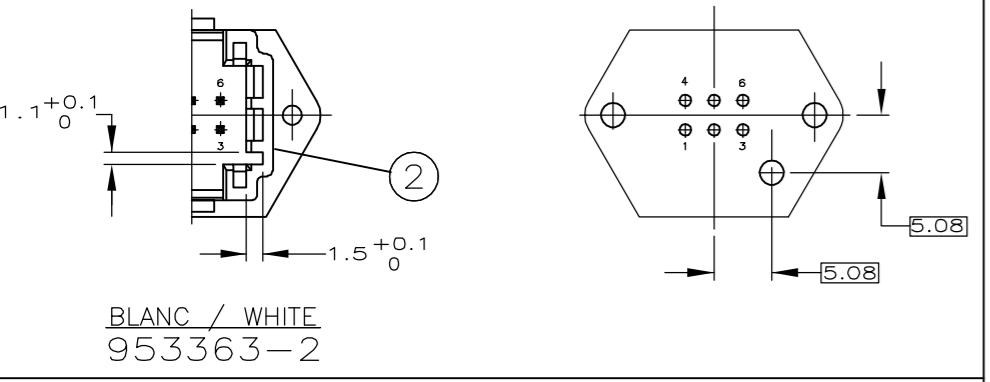
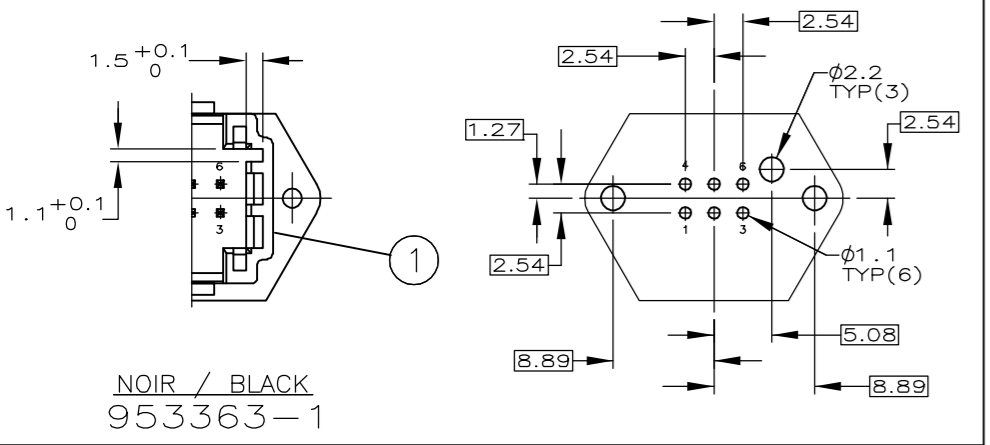

- NOTES:
- ① DATE CODE
 - ② LOGO D'AMP
 - ③ REFERENCE DU PRODUIT ASSEMBLE
 - ④ N° D'EMPREINTE DU MOULE
 - ⑤ REVISION DU MOULE
 - ⑥ MATIERE

- NOTES:
- ① DATE CODE
 - ② AMP LOGO
 - ③ ASSY PART NUMBER
 - ④ CAVITY MARKING
 - ⑤ REVISION STATUS
 - ⑥ MATERIAL REFERENCE

DECOUPE PANNEAU / PANEL CUTOUT

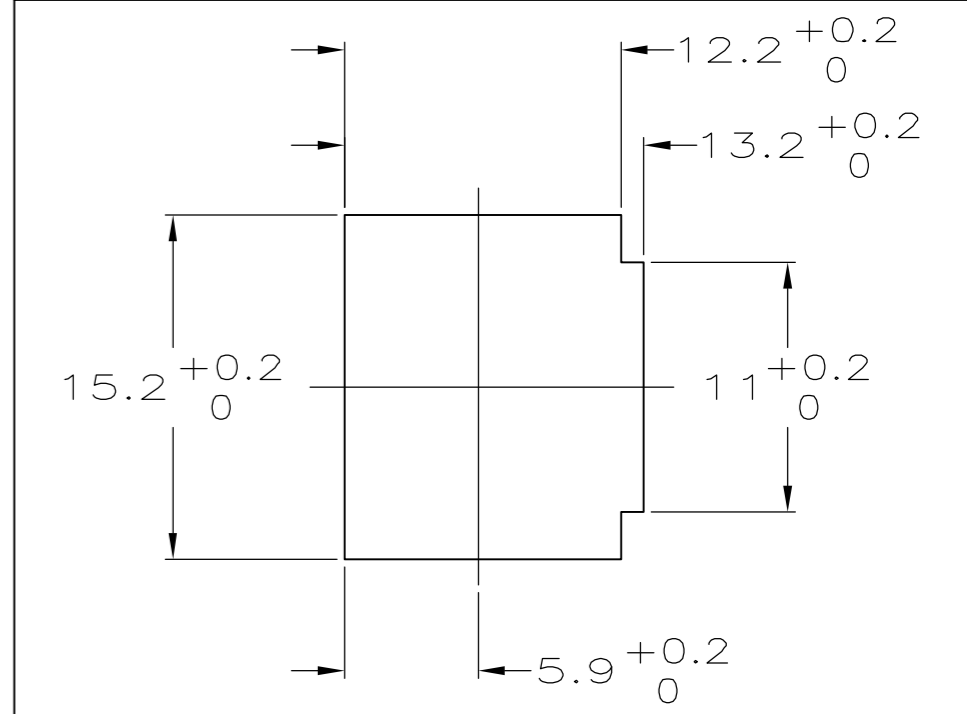

ASSY. PN	REV	MATERIAL	DESIGNATION / NAME	COULEUR / COLOR FINITION	REP.
953363-1	-	CuSn6	MQS CONTACT	DORURE SELECTIVE 0.4µm mini Au sur 1µm mini Ni SELECTIVE GOLD PLATING 0.4µm mini Au over 1µm mini Ni	⑤
953363-2	-	PBT GF20	BOITIER / HOUSING	POST ETAME / POST TIN	④
953363-3	-	PBT GF20	BOITIER / HOUSING	GREEN / VERT	③
953363-4	-	PBT GF20	BOITIER / HOUSING	MARRON / BROWN	②
1-953363-3	-	PBT GF20	BOITIER / HOUSING	WHITE / BLANC	①
1-953363-3	6	PBT GF20	BOITIER / HOUSING	NOIR / BLACK	①
QTY		MATERIAL	DESIGNATION / NAME	COULEUR / COLOR FINITION	REP.

THIS DRAWING IS A CONTROLLED DOCUMENT.
 CE SCHEMA EST UN DOCUMENT CONTROLÉ

TOLERANCES UNLESS OTHERWISE SPECIFIED:
 TOLERANCES NON SPECIFIEES (SUIV NB DE DECIMALES):
 ANGLES 45°

FINISH FINITION

APPROVED: J.J. REVIL
 DATE: 28-JAN-99

WEIGHT MASSE APPROX. 2 g

CUSTOMER DRAWING/PLAN CLIENT

tyco Electronics
 Tyco Electronics Corporation
 Pontoise, 95300 FRANCE

NAME TITRE: EMBASE 6V MQS DROITE AVEC OREILLES
 6W MQS STRAIGHT HEADER WITH EARS

SIZE FORMAT: A2
 CAGE CODE: 00779
 DRAWING NO: C=953363

RESTRICTED TO: -

SCALE ECHELLE: 5:1
 SHEET FEUILLE: 1 DE 1
 REV: F

953363

A