

HEAVY DUTY CONNECTORS

Contents

Introduction	4
General Overview of Heavy Duty Connectors	4
TE Heavy Duty Connectors – Applications	6
HDC Component Overview	8
Selection Guide	9
Terminal Type	13
Selecting PG Cable Glands	14
Selecting Metric Cable Glands	15
Inserts	16
HA Series	16
HE Series	17
HEE Series	19
HEEE Series	20
HVE Series	21
HD Series	22
HDD Series	24
HQ Series & HSB Series	25
HEAV Series	26
HK & HWK Series	27
Modular Inserts	28
HMN Modular Connectors Overview	29
HMN Series	30
HCM Series	32
Tools and Accessories	36
Contacts	37
Contact – DD & EE series	37
Contact – MM series	37
Contact – 100A Series	38
Contact – 5A Series	38
Compatible Adapter	38

Insert Mounting Elements	39
Coding Pin	40
Hoods and Housings IP65	41
H3A Hoods and Housings.....	41
H8A Thermoplastic and H10A & H16A Metal Hoods and Housings.....	42
H32A Metal Hoods and Housings	43
H6B Metal Hoods and Housings.....	44
H10B Metal Hoods and Housings	45
H16B Metal Hoods and Housings	47
H24B Metal Hoods and Housings	49
H32B with 2 Levers on the Hoods and Housings	51
H48B Metal Hoods and Housings	52
EMC Hoods and Housings	53
HB (IP65) Series Central lever locking.....	54
Hoods and Housings IP68	55
H3APR (IP68) Hoods and Housings	55
HBPR (IP68) Hoods and Housings	56
Cable Glands	59
Metal Cable Glands - Brass Nicked-plated.....	59
Nylon Cable Glands - Nylon Sealing Insert	60
Metal Cable Glands - Multiple Sealing Insert.....	62
Special Sealing Insert Glands	63
Metal Glands with Multiple Seal	64
Metal Clamp Glands with Multiple Seal	66
Metal Clamp Glands.....	66
Metal Lock Nuts.....	67
Metal Increasers.....	68
Inside and Outside Thread Adapter	69

General Overview of Heavy Duty Connectors

TE has been producing Heavy Duty Connectors (HDC) for over 60 years. The portfolio includes one of the very best in quality and sustainability, helping you to reduce go-to-market time.

Featuring a modular design, TE HDCs fit perfectly in our one-piece frame, to make installation more convenient and time-saving. Moreover, the docking frame allows for blind mating in spaces with limited visibility and offers direct access, for easier installation, when compared to more traditional solutions.

With up to 48 pins in a single module, TE's HDCs provide one of the highest density in the market for maximum space saving in the application.

TE HDCs are available with low minimum order quantities and are fully backed by TE's expert engineering support in all regions.

KEY BENEFITS

- **Robustness:** designed to deliver reliable performance under the most demanding operating and environmental conditions.
- **Maximum flexibility:** multiple options to meet applications more accurately.
- **Design freedom:** flexible designs so customers can choose/create a DIY interface for their equipment.
- **Sustainability:** The industry-standardized interface and TE's global footprint help to reduce customers' supply chain risks.

KEY FEATURES

- Metal and thermoplastic enclosures
- Various specifications for power, signal and data
- Modular design
- High current solution

SPECIFICATIONS

- DIN EN 175 301-801
- DIN EN 60664-1
- DIN EN 61 984

PRODUCT CERTIFICATIONS



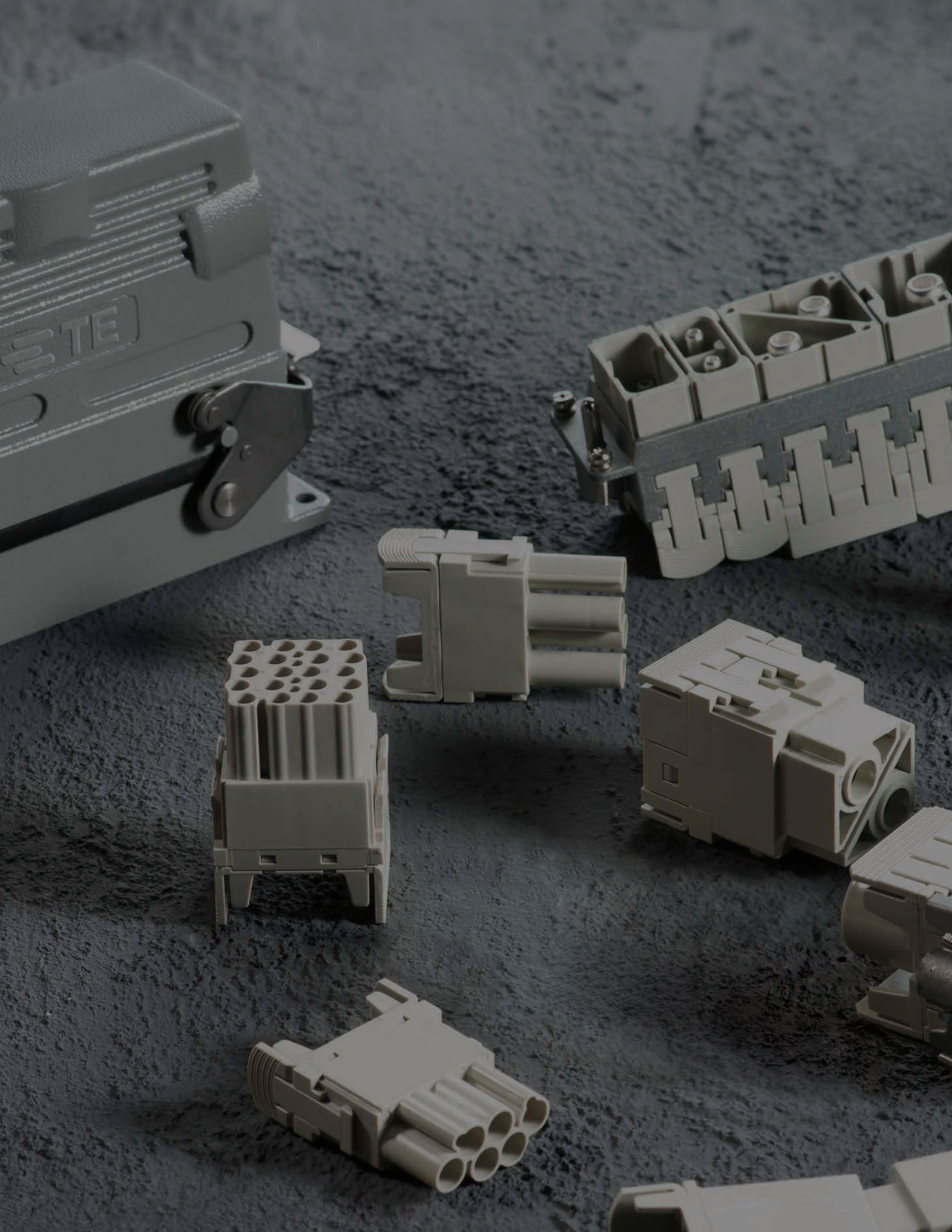

TE Heavy Duty Connectors - Applications

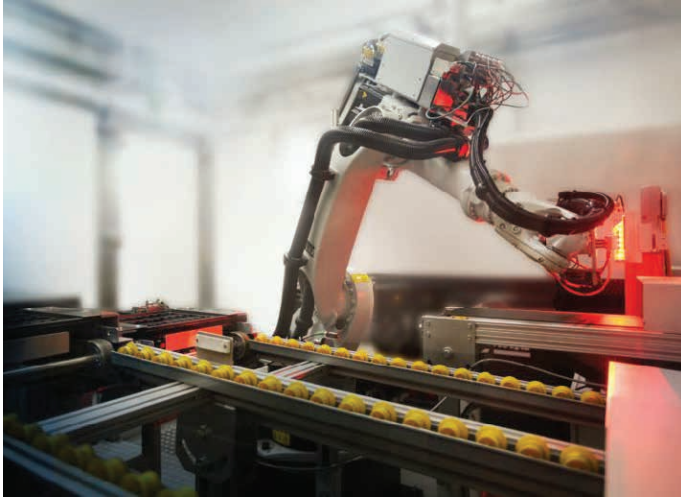

ROBOTICS

TE Provides flexibility, convenience and high density solution in Robotics application to enable automation with minimal space.

- **HMN series**
 - Modular design
 - Easy for interface configuration
 - Integrated solution to transmit power, signal, and data
- **HDD/HEEE/HQ series**
 - High density solution
 - Space saving with compact design
- **EMC Version Hoods and Housings**
 - 360° EMI Protection

TE provides complete portfolio solution that can easily satisfy the various connection and space requirement in machinery application.

- **HMN**
 - Modular design
 - Easy for interface configuration
 - Integrated solution to transmit power, signal, and data
- **HE/HA/HD Series**
 - Wide range of different versions regarding Pin quantities, connector size, capability for current and voltage requirements
 - Wide range of contacts available with different plating
 - Hoods and Housings with Coating or EMC protection to fit various solutions requirements



MACHINERY

TE Heavy Duty Connectors - Applications



RAIL

TE provides rail compliance insert, high-current series together with robust protection in Rail application

- **HCM**
 - High current and high power connections required in Rail market
- **EN45545 compliant inserts HDD, HEE and HEEE**
 - Compliant with safety requirements in Rail applications
 - High density connectors for signal transmission
- **EN45545 compliant HMN system**
 - Compliant with safety requirements in Rail applications
 - Enable modular configuration of customer specific interface
 - Offer Multiple connection options including power, signal, and data
- **HBPR enclosures**
 - Corrosion resistant enclosures with IP68 protection
 - Suitable for outdoor applications

TE provides flexibility, high density solution with robust protection in Wind Power application to realize safe and reliable connection in harsh environment.

- **HMN**
 - Modular design
 - Easy for interface configuration
 - Integrated solution to transmit power, signal, and data
- **HQ/HEEE/HDD**
 - High density solution
 - Space saving with compact design
- **IP 68/69K Hoods and Housings**
 - Up to 500H Salt spray protection
- **HE Spring inserts**
 - Reliable solution for wiring
 - Maintenance free



POWER

HDC Components Overview

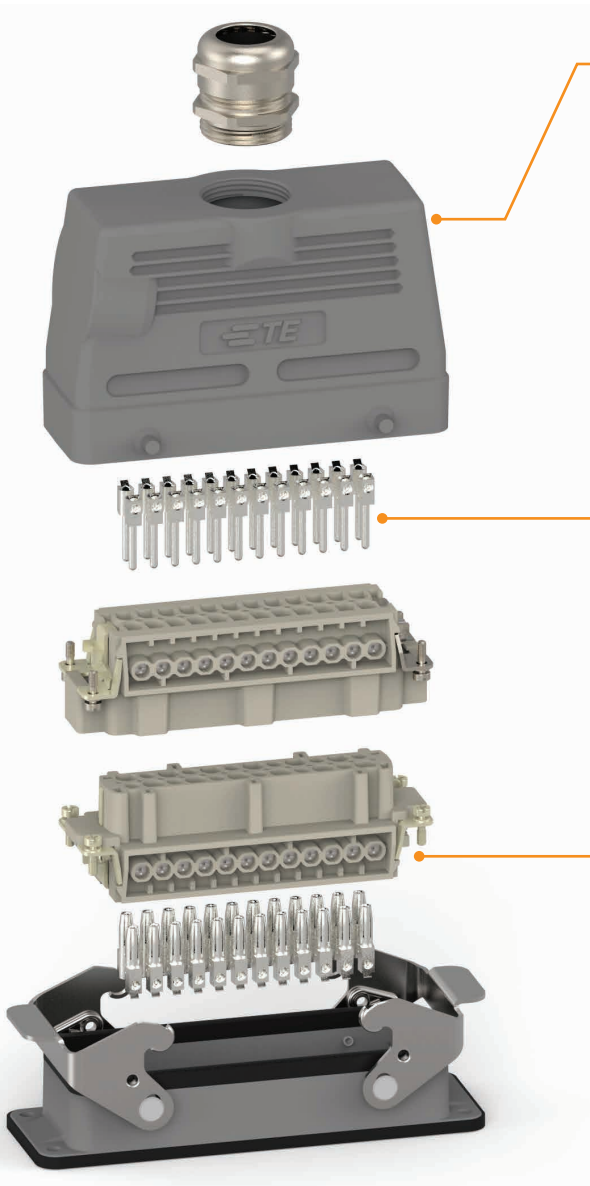

HOODS & HOUSINGS

Extremely impact-resistant and robust surface due to powder coating to enable the usage in harsh environment, available in many versions:

- Protection degrees IP65, IP67, IP68 and IP69k
- Standard, pressure-tight, EMC and corrosion resistant variants
- Anti-corrosion series with excellent protection against corrosion and environmental influences due to hard anodic oxidation layer (hard coating):
 - 500H salt spray test resistance (BPR/HCM)
 - 1000H salt spray test resistance (HIP-K)
- Available in standard and high construction version

CONTACT SYSTEMS

- 5A - 650A
- Crimp contacts: highest contact density, special tools necessary, vibration proof, gas-tight termination, suitable for termination with crimping machines
- Screw termination: no special tools necessary
- Spring clamp: no special tools necessary, vibration proof

INSERT

- Certified approval according to TÜV, UL as well as CSA
- Flame-retardant materials according to UL94-V0
- Available for screw, crimp and cage clamp termination
- Combination inserts for signal and power contacts in one insert - HK/HWK series, HMN modular system
- Up to 216 pins in one connector



HMN MODULAR SYSTEM

- High flexibility and possibility of customization
- Combination of different technologies within one connector: Power, Signal, Pneumatic, RJ45, D-Sub, USB, Quint
- Current up to 200A
- Voltage up to 1000V
- One-piece frame enabling tool less assembly
- Male and female in 1 frame possible
- HMN docking frame enables Blind mating

SELECTION GUIDE

When selecting heavy duty connector, we need to choose as following:

Bulkhead Mounting Type



- Cable gland
- Hood
- Male contacts
- Male insert
- Female insert
- Female contacts
- Bulkhead mounting Housings

(I) Side entry (II) Top entry

Surface Mounting Type



- Cable gland
- Hood
- Male contacts
- Male insert
- Female insert
- Female contacts
- Surface mounting Housings

(III) Side entry (IV) Top entry

Cable to Cable Type



- Cable gland
- Hood
- Male contacts
- Male insert
- Female insert
- Female contacts
- Cable to cable coupling

(V) Side entry (VI) Top entry

Through-panel Type

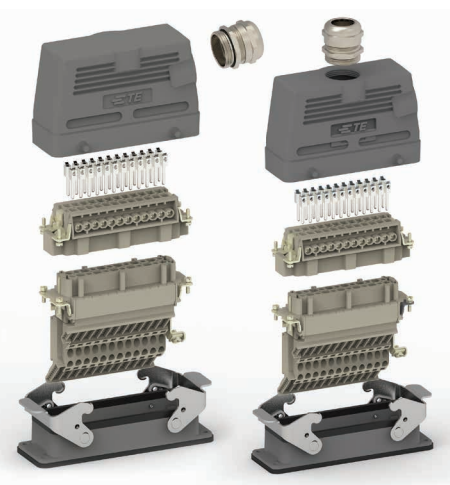

- Cable gland
- Hood
- Male contacts
- Male insert
- Female insert
- Female contacts
- Bulkhead mounting Housings

(VII) Side entry (VIII) Top entry

Selection Guide

Insert	Type	Poles	Current	Voltage	Terminal	Contacts	Hoods/Housings
HA	HA-003	3+PE	10	250	Screw terminal	-	H3A
	HA-004	4+PE	10	250	Screw terminal	-	H3A
	HA-010	10+PE	16	250	Screw terminal	CEM/F(16A)	H10A
	HA-016	16+PE	16	250	Crimp terminal	DEM/F(16A)	H16A
	HA-003-S	3+PE	10	400	Spring terminal		H3A
	HA-004-S	4+PE	10	400	Spring terminal		H3A
HE	HE-006	6+PE	16A	500V	Screw terminal Crimp terminal Spring terminal Double spring	CEM/F(16A) DEM/F(16A)	H6B
	HE-010	10+PE	16A	500V			H10B
	HE-016	16+PE	16A	500V			H16B
	HE-024	24+PE	16A	500V			H24B
	HE-032	32+PE	16A	500V			H32B
	HE-048	48+PE	16A	500V			H48B
HEE	HEE-010	10+PE	16A	500V	Crimp terminal	CEM/F(16A) DEM/F(16A)	H6B
	HEE-018	18+PE	16A	500V			H10B
	HEE-032	32+PE	16A	500V			H16B
	HEE-046	46+PE	16A	500V			H24B
	HEE-064	64+PE	16A	500V			H32B
	HEE-092	92+PE	16A	500V			H48B
HEEE	HEEE-020	20+PE	16A	400V	Crimp terminal	CEM/F(16A)	H6B
	HEEE-032	32+PE	16A	400V		DEM/F(16A)	H10B
	HEEE-040	40+PE	16A	500V			H16B
	HEEE-048	48+PE	16A	400V			H16B
	HEEE-064	64+PE	16A	500V			H24B
	HEEE-072	72+PE	16A	400V			H24B
	HEEE-080	80+PE	16A	500V			H32B
	HEEE-096	96+PE	16A	400V			H32B
	HEEE-128	128+PE	16A	500V			H48B
	HEEE-144	144+PE	16A	400V			H48B
HVE	HVE-003	3+PE+2	16A	830V	Screw terminal	-	H10B
	HVE-006	6+PE+2	16A	830V			H16B
	HVE-010	10+PE+2	16A	830V			H24B
	HVES-003	3+PE+2	16A	830V	Spring terminal	-	H10B
	HVES-006	6+PE+2	16A	830V			H16B
	HVES-010	10+PE+2	16A	830V			H24B
	HVEC-003	3+PE+2	16A	830V	Crimp terminal	CEM/F(16A) DEM/ F(16A)	H10B
	HVEC-006	6+PE+2	16A	830V			H16B
	HVEC-010	10+PE+2	16A	830V			H24B

TE Connectivity's Heavy Duty Connectors

Selection Guide

Selection Guide

Insert	Type	Poles	Current	Voltage	Terminal	Contacts	Hoods/Housings
HD	HD-007	7+PE	10A	250V	Crimp terminal	CDM/F(10A) DDM/F(10A)	H3A
	HD-008	8	10A	50V			H3A
	HD-015	15+PE	10A	250V	Crimp terminal Rolled contacts	CDM/F(10A) DDM/F(10A) CJM/F(10A)	H10A
	HD-025	25+PE	10A	250V			H16A
	HD-040	40+PE	10A	250V			H16B
	HD-050	50+PE	10A	250V			H32A
	HD-064	64+PE	10A	250V			H24B
	HD-080	80+PE	10A	250V			H32B
HD-128	128+PE	10A	250V	H48B			
HDD	HDD-016	16+PE	10A	250V	Crimp terminal	CDM/F(10A) DDM/F(10A)	H6B
	HDD-024	24+PE	10A	250V	Crimp terminal Rolled contacts	CDM/F(10A) DDM/F(10A) CJM/F(10A)	H6B
	HDD-042	42+PE	10A	250V			H10B
	HDD-072	72+PE	10A	250V	Crimp terminal	CDM/F(10A) DDM/F(10A)	H16B
	HDD-108	108+PE	10A	250V	Crimp terminal	CDM/F(10A) DDM/F(10A)	H24B
	HDD-144	144+PE	10A	250V	Crimp terminal	CDM/F(10A) DDM/F(10A)	H32B
	HDD-216	216+PE	10A	250V	Crimp terminal	CDM/F(10A) DDM/F(10A)	H48B
HSB	HSB-006	HSB-006	35A	690V	Screw terminal	-	H16B
	HSB-012	HSB-012	35A	690V	Screw terminal	-	H32B
HEAV	HEAV-006	6+PE	16A	500V	Spring terminal	-	H6B
	HEAV-010	10+PE	16A	500V			H10B
	HEAV-016	16+PE	16A	500V			H16B
	HEAV-024	24+PE	16A	500V			H24B
	HEAV-032	32+PE	16A	500V			H32B
	HEAV-048	48+PE	16A	500V			H48B
HK&HWK	HK-4/0	4+PE	80A	690V	Screw terminal	-	H16B
	HK-4/2	4/2+PE	80/16A	690/400V	Screw terminal	-	H16B
	HK-4/8	4/8+PE	80/16A	400/400V	Screw terminal	-	H24B
	HK-6/36	6/36+PE	40/10A	690/250V	Crimp terminal	CMM/F(40A) DMM/F(40A) CDM/F(10A) DDM/F(10A)	H16B
	HK-8/24	8/24+PE	16/10A	400/250V	Crimp terminal	CEM/F&DEM/F(16A) CDM/F&DDM/F(10A)	H10B
	HK-12/2	12/2+PE	40/10A	500/250V	Crimp terminal	CMM/F&DMM/F(40A) CDM/F&DDM/F(10A)	H16B
	HWK6/6	6/6+PE	40/16A	690/400V	Screw terminal	-	H16B
HWK3/6/6	3/6/6+PE	100/40/16A	690/690/400V	Screw terminal	-	H24B	
HQ	HQ-002	2+PE	40A	400V	Crimp terminal	CMM/F&DMM/F(40A)	H3A
	HQ-002-P	2+PE	40A	830V	Crimp terminal	CMM/F&DMM/F(40A)	H3A
	HQ-005	5+PE	16A	400V	Crimp terminal	CEM/F&DEM/F(16A)	H3A
	HQ-007	7+PE	10A	400V	Crimp terminal	CDM/F&DDM/F(10A)	H3A
	HQ-008	8+PE	16A	500V	Crimp terminal	CEM/F&DEM/F(16A)	H8A
	HQ-012	12+PE	10A	400V	Crimp terminal	CDM/F&DDM/F(10A)	H8A
	HQ-017	17+PE	10A	250V	Crimp terminal	CDM/F&DDM/F(10A)	H8A
	HQ4/2	4/2	40/10A	690V/250V	Crimp terminal	CMM/F&DMM/F(40A) CDM/F&DDM/F(10A)	H8A

TE Connectivity's Heavy Duty Connectors

Selection Guide

Insert	Type	Poles	Current	Voltage	Terminal	Contacts	Frame
HMN	HMN-001	1	200A	1000V	Crimp terminal	CHM/F&DHM/F(200A)	H10A-T1 H6BN-T2 H10BN-T3 H16BN-T4 H24BN-T6
	HMN-D2	2	100A	1000V	Crimp terminal	CNM/F&DNM/F(100A)	
	HMN-002	2	70A	1000V	Crimp terminal	CSM/F&DSM/F(70A)	
	HMN-003	3	40A	690V	Crimp terminal	CMM/F&DMM/F(40A)	
	HMN-004	4	40A	830V	Crimp terminal	CMM/F&DMM/F(40A)	
	HMN-005	5	16A	400V	Spring terminal	-	
	HMN-006	6	16A	500V	Crimp terminal	CEM/F&DEM/F(16A)	
	HMN-006-P	6	16A	830V	Crimp terminal	CEM/F&DEM/F(16A)	
	HMN-008	8	16A	400V	Crimp terminal	CEM/F&DEM/F(16A)	
	HMN-012	12	10A	250V	Crimp terminal	CDM/F&DDM/F(10A)	
	HMN-017	17	10A	160V	Crimp terminal	CDM/F&DDM/F(10A)	
	HMN-020	20	16A	500V	Crimp terminal	CEM/F&DEM/F(16A)	
	HMN-025	25	5A	50V	Crimp terminal	CAM/F&DAM/F(5A)	
	HMN-009	9	5A	50V	Crimp terminal	CAM/F&DAM/F(5A)	
	HMN-RJ45	1	1A	50V	RJ45	-	
	HMN-USB	1	-	-	USB	-	
	HMN-PA2	2	-	-	Pneumatic contacts	-	
	HMN-PA3	3	-	-	Pneumatic contacts	-	
	HMN-Q1	2	16A/10A	50V	Shielding	Quintax-001	
	HMN-Q2	2	10A	50V	Shielding	Quintax-004	
HMN-Q3	2	5A	50V	Shielding	Quintax-008		
Quintax-001	1	16A	50V	Crimp terminal	CEM/F&DEM/F(16A)		
Quintax-001	1	10A	50V	Crimp terminal	CDM/F&DDM/F(10A)		
Quintax-004	4	10A	50V	Crimp terminal	CDM/F&DDM/F(10A)		
Quintax-008	8	5A	50V	Crimp terminal	CAM/F&DAM/F(5A)		
HMN-DM	-	-	-	-	-		
Insert	Type	Module units					Hoods/Housings
Frame	H10A-T1	1					H10A
	H6BN-T2	2					H6B
	H10BN-T3	3					H10B
	H16BN-T4	4					H16B
	H24BN-T6	6					H24B
Insert	Type	Poles	Current	Voltage	Terminal	Contacts	Frame
HCM	HCM250	1	250A	2000V	Crimp terminal	HCM250-MC/FC	H16BRP-2P-250 H24BPR-4P-250
	HCM350	1	350A	2000V	Crimp terminal	HCM350-MC/FC	H6BPR-1P-350 H16BPR-2P-350 H24BRP-3P-350 H32BRP-4P-350
	HCM650	1	650A	4000V	Crimp terminal	HCM650-MC/FC	H6BPR-1P-650 H24BPR-2P-650 H24BPR-3P-650
Insert	Type	Module units					Hoods/Housings
Frame	H16BRP-2P-250	2					H16BRP
	H24BPR-4P-250	4					H24BRP
	H6BPR-1P-350	1					H6BRP
	H16BPR-2P-350	2					H16BRP
	H24BRP-3P-350	3					H24BRP
	H32BRP-4P-350	4					H32BRP
	H6BPR-1P-650	1					H6BRP
	H24BPR-2P-650	2					H24BRP
H24BPR-3P-650	3					H24BRP	

TE Connectivity's Heavy Duty Connectors

Terminal Type

Terminal Type

Screw terminal

HA series
HE, HVE series
HSB series
HK series
HWK series
HEAV series

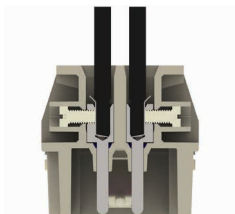

Inserts	Max.wire gauge		Stripping length L (mm)
	mm ²	AWG	
HA-003, HA-004	2.5	14	4.5
HE, HA, HEAV	2.5	14	7.5
HE, HVE	4	12	7.5
HSB	6	10	11.5
HK, HWK	16	5	14

Crimp terminal

HD series
HDD series



Inserts	Max.wire gauge		Stripping length L (mm)	
	mm ²	AWG	HDD/HD	HEC/HAC
HD HDD HM(10A)	0.5	20	8	7.5
	0.75	18	8	7.5
	1	18	8	7.5
	1.5	16	8	7.5
	2.5	14	8	7.5
	4	12	-	7.5

HEC, HEE series
HEEE series
HMN series

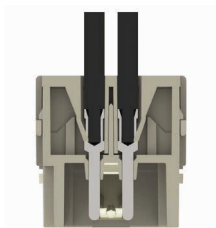

Inserts	Max.wire gauge		Stripping length L (mm)
	mm ²	AWG	HEE/HMN (40A)
HEC HEE HEEE HM(40A)	0.5	20	7.5
	0.75	18	7.5
	1	18	7.5
	1.5	16	7.5
	2.5	14	7.5
4	12	7.5	

Spring Terminal

HAS series
HES series
HESAV series

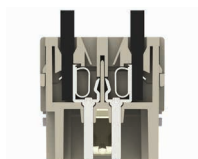

Inserts	Max.wire gauge		Stripping length L
	mm ²	AWG	(mm)
HAS, HES, HESAV	0.14-2.5	26-14	9-11

Recommended tightening torque and size of screw driver

Size of screw	Connector type	Tightening torque [Nm]	Tightening torque [lbft]	Recommended size of screw driver
M3	Screw terminal HA-003/HA-004/HQ-005	0.25	0.2	0.4x2.5
M3	Screw terminal HA-010, HA-016	0.5	0.4	0.5x3.5 or ±size 1
M3	Screw terminal HE, HVAE fixing screws of all kinds, guiding pins and bushes	0.5	0.4	0.5x3.5
M4	Ground terminal HA, HE, HD, HDD	1.2	0.9	0.5x3.5 or ±size 1+2
M4	Terminal blocks HSB	1.2	0.9	0.8x4.5
M5	Ground terminal HSB	2	1.4	0.8x4.5 - 1.2x8.0

Selecting PG Cable Glands

THE PG SIZES INDICATED ARE INTENDED FOR STANDARD CABLES.

Cross-sec	No. of cond. Φ	Cable approx.	Metric with multi-layer sealing				
0.5 mm ²	4	6.7 - 9.7	11				
AWG 20	6	7.6 - 10.6	11	13.5	16		
	10	9.4 - 12.8	11	13.5	16		
	16	10.7 - 13.9	11	13.5	16		
	24	13.5 - 16.7		13.5	16	21	
	30	14.3 - 17.5		13.5	16	21	
	35	16 - 18.6			16	21	
	40	16.6 - 19.2				21	
	61	20.3 - 23.1				21	29

Cross-sec	No. of cond. Φ	Cable approx.	Metric with multi-layer sealing					
1.5 mm ²	4	9.7 - 1.8	11	13.5	16			
AWG 16	6	10.8 - 14.2	11	13.5	16			
	11	13.6 - 16.8		13.5	16	21		
	16	15.8 - 18.4			16	21		
	25	20.2 - 23				21	29	
	32	23.8 - 24.5					29	36
	42	25.8 - 29					29	36
	50	27 - 30.2					29	36
	61	28.6 - 31.8					29	36

Cross-sec	No. of cond. Φ	Cable approx.	Metric with multi-layer sealing				
0.75 mm ²	4	7.9 - 10.3	11				
AWG 18	6	8.9 - 12.3	11				
	10	10.4 - 13.8	11	13.5	16		
	18	13 - 16.2		13.5	16		
	25	15.9 - 18.5			16	21	
	32	17.1 - 19.7				21	29
	40	19 - 21.4				21	29
	50	21.3 - 24.1				21	29
	61	22.6 - 25.4				21	29

Cross-sec	No. of cond. Φ	Cable approx.	Metric with multi-layer sealing					
2.5 mm ²	4	11.7 - 14.4	11	13.5	16			
AWG 12 - 14	6	13.3 - 16.7		13.5	16	21		
	7	13.3 - 16.7		13.5	16	21		
	11	18 - 20.6				21	29	
	16	20.6 - 23.4				21	29	
	18	21.7 - 24.5					29	36
	25	26.4 - 29.6					29	36
	34	31.3 - 33.1					29	36
	50	37 - 39.4						42

Cross-sec	No. of cond. Φ	Cable approx.	Metric with multi-layer sealing				
1 mm ²	4	8.4 - 10.7	11	13.5			
AWG 16 - 18	6	9.2 - 12.6	11	13.5	16		
	10	1 - 14.4	11	13.5	16	21	
	16	13 - 16.2		13.5	16	21	
	24	16.5 - 19.1				21	29
	34	19.4 - 21.8				21	29
	48	22 - 24.8				21	29
	61	24.5 - 27.2					29

Cross-sec	No. of cond. Φ	Cable approx.	Metric with multi-layer sealing					
4 mm ²	2	10.7 - 14.1	11	13.5	16	21		
AWG 10 - 12	4	13 - 16.4		13.5	16	21		
	5	14.3 - 17.7			16	21		
	7	16.2 - 19.6				21	29	36
	10	approx. 24.5					29	36

TE Connectivity's Heavy Duty Connectors

Selecting Cable Glands

Selecting Metric Cable Glands

THE METRIC-SIZES INDICATED ARE INTENDED FOR STANDARD CABLES.

PLEASE OBSERVE THE CLAMPING RANGE OF YOUR CHOICE OF METRIC CABLE GLANDS.

Cross-sec	No. of cond. Φ	Cable approx.	Metric with multi-layer sealing				
			16	20			
0.5 mm ²	4	6.7 - 9.7	16	20			
AWG 20	6	7.6 - 10.6	16	20	16		
	10	9.4 - 12.8	16	20	16	25	
	16	10.7 - 13.9		20	16	25	
	24	13.5 - 16.7			16	25	32
	35	16 - 18.6				25	32
	40	16.6 - 19.2				25	32
	61	20.3 - 23.1					32

Cross-sec	No. of cond. Φ	Cable approx.	Metric with multi-layer sealing				
			16	20	25		
1.5 mm ²	4	9.7 - 1.8	16	20	25		
AWG 16	6	10.8 - 14.2		20	25		
	10	13.6 - 16.8			25	32	
	16	15.8 - 18.4			25	32	
	25	20.2 - 23				32	40
	32	23.8 - 24.5					40
	42	25.8 - 29					40
	61	28.6 - 31.8					40

Cross-sec	No. of cond. Φ	Cable approx.	Metric with multi-layer sealing				
			16	20			
0.75 mm ²	4	7.9 - 10.3	16	20			
AWG 18	6	8.9 - 12.3	16	20	25		
	10	10.4 - 13.8		20	25		
	18	13 - 16.2			25	32	
	25	15.9 - 18.5			25	32	
	32	17.1 - 19.7			25	32	
	40	19 - 21.4				32	40
	50	21.3 - 24.1				32	40
	61	22.6 - 25.4					40

Cross-sec	No. of cond. Φ	Cable approx.	Metric with multi-layer sealing				
			20	25			
2.5 mm ²	4	10.7 - 14.4	20	25			
AWG 12 - 14	6	13.3 - 16.7		25			
	10	18 - 20.6		25	32		
	16	20.6 - 23.4			32	40	
	25	26.4 - 29.6			32	40	50
	34	31.3 - 33.1				40	50
	50	37 - 39.4				40	50
	61	39 - 41.5					50







Cross-sec	No. of cond. Φ	Cable approx.	Metric with multi-layer sealing				
			16	20			
1 mm ²	4	8.4 - 10.7	16	20			
AWG 16 - 18	6	9.2 - 12.6	16	20	25		
	10	1 - 14.4		20	25	32	
	16	13 - 16.2			25	32	
	24	16.5 - 19.1			25	32	40
	34	19.4 - 21.8			25	32	40
	48	22 - 24.8				32	40
	61	24.5 - 27.2				32	40



Cross-sec	No. of cond. Φ	Cable approx.	Metric with multi-layer sealing				
			20	25			
4 mm ²	2	10.7 - 14.1	20	25			
AWG 10 - 12	4	13 - 16.4		25	32		
	5	14.3 - 17.7		25	32		
	7	16.2 - 19.6		25	32		
	10	approx. 24.5				40	

HA Series

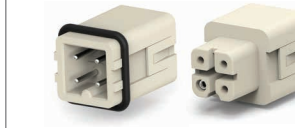
HA SERIES INSERTS CAN MATCH THE HA SERIES HOODS AND HOUSINGS. SEE PAGE 41 TO 43.

Inserts

3+ 			3+ 			4+ 			4+ 		
Screw Terminal			Spring Terminal			Screw Terminal			Spring Terminal		
											
Type	PN		Type	PN		Type	PN		Type	PN	
Male (M)	HA-003-M	T2010032101-000	Male (M)	HA-003-MS	T2010033101-000	Male (M)	HA-004-M	T2010042101-000	Male (M)	HA-004-MS	T2010043101-000
Female (F)	HA-003-F	T2010032201-000	Female (F)	HA-003-FS	T2010033201-000	Female (F)	HA-004-F	T2010042201-000	Female (F)	HA-004-FS	T2010043201-000
Tech Data	Rated current: 10A Rated voltage: 250V Terminal: Screw terminal 2 Wiregauge: 0.14-2.5mm ²		Tech Data	Rated current: 10A Rated voltage: 400V Terminal: Spring terminal 2 Wiregauge: 0.14-2.5mm ²		Tech Data	Rated current: 10A Rated voltage: 250V Terminal: Screw terminal 2 Wiregauge: 0.14-2.5mm ²		Tech Data	Rated current: 10A Rated voltage: 400V Terminal: Spring terminal 2 Wiregauge: 0.14-2.5mm ²	
Hoods & Housings	For H3A series see page 41		Hoods & Housings	For H3A series see page 41		Hoods & Housings	For H3A series see page 41		Hoods & Housings	For H3A series see page 41	

10+ 			16+ 			16+ 		
Screw Terminal			Screw Terminal			Crimp Terminal (Order crimp contacts separately)		
								
Type	PN		Type	PN		Type	PN	
Male (M)	HA-010-M	T2010102101-000	Male (M)	HA-016-M	T2010162101-000	Male (M)	HA-016-MC	T2010164101-000
Female (F)	HA-010-F	T2010102201-000	Female (F)	HA-016-F	T2010162201-000	Female (F)	HA-016-FC	T2010164201-000
Tech Data	Rated current: 16A Rated voltage: 250V Terminal: Screw terminal Wiregauge: 0.14-2.5mm ²		Tech Data	Rated current: 16A Rated voltage: 250V Terminal: Screw terminal Wiregauge: 0.14-2.5mm ²		Tech Data	Rated current: 16A Rated voltage: 250V Terminal: Crimp terminal Wiregauge: 0.14-4.0mm ²	
Hoods & Housings	For H10A series see page 42		Hoods & Housings	For H16A series see page 42		Hoods & Housings	For H16A series see page 42	

32+ 			32+ 		
Screw Terminal			Crimp Terminal (Order crimp contacts separately)		
					
Type	PN		Type	PN	
Male (M)	HA-016-M HA-016-M 17-32	T2010162101-000 T2010322101-000	Male (M)	HA-016-MC HA-016-MC 17-32	T2010164101-000 T2010324101-000
Female (F)	HA-016-F HA-016-F 17-32	T2010162201-000 T2010322201-000	Female (F)	HA-016-FC HA-016-FC 17-32	T2010164201-000 T2010324201-000
Tech Data	Rated current: 16A Rated voltage: 250V Terminal: Screw terminal Wiregauge: 0.14-2.5mm ²		Tech Data	Rated current: 16A Rated voltage: 250V Terminal: Crimp terminal Wiregauge: 0.14-4.0mm ²	
Hoods & Housings	For H32A series see page 43		Hoods & Housings	For H32A series see page 43	

TE Connectivity's Heavy Duty Connectors

Inserts

HE Series

HE SERIES INSERTS CAN MATCH THE HB SERIES HOODS AND HOUSINGS. SEE PAGE 44 TO 52.

6+			6+			6+			6+		
Screw Terminal			Spring Terminal			Crimp Terminal (Order crimp contacts separately)			Spring Terminal (Two terminals per contact)		
	Type	PN		Type	PN		Type	PN		Type	PN
Male (M)	HE-006-M	T2040062101-000	Male (M)	HE-006-MS	T2040063101-000	Male (M)	HE-006-MC	T2040064101-000	Male (M)	HE-006-MSS	T2040065101-000
Female (F)	HE-006-F	T2040062201-000	Female (F)	HE-006-FS	T2040063201-000	Female (F)	HE-006-FC	T2040064201-000	Female (F)	HE-006-FSS	T2040065201-000
Tech Data	Rated current: 16A Rated voltage: 500V Terminal: Screw terminal 2 Wiregauge: 0.14-4mm ²		Tech Data	Rated current: 16A Rated voltage: 500V Terminal: Spring terminal 2 Wiregauge: 0.5-2.5mm ²		Tech Data	Rated current: 16A Rated voltage: 500V Terminal: Crimp terminal 2 Wiregauge: 0.14-4mm ²		Tech Data	Rated current: 16A Rated voltage: 500V Terminal: Spring terminal 2 Wiregauge: 0.5-2.5mm ²	
Hoods & Housings	For H6B series see page 44		Hoods & Housings	For H6B series see page 44		Hoods & Housings	For H6B series see page 44		Hoods & Housings	For H6B series see page 44	

10+			10+			10+			10+		
Screw Terminal			Spring Terminal			Crimp Terminal (Order crimp contacts separately)			Spring Terminal (Two terminals per contact)		
	Type	PN		Type	PN		Type	PN		Type	PN
Male (M)	HE-010-M	T2040102101-000	Male (M)	HE-010-MS	T2040103101-000	Male (M)	HE-010-MC	T2040104101-000	Male (M)	HE-010-MSS	T2040105101-000
Female (F)	HE-010-F	T2040102201-000	Female (F)	HE-010-FS	T2040103201-000	Female (F)	HE-010-FC	T2040104201-000	Female (F)	HE-010-FSS	T2040105201-000
Tech Data	Rated current: 16A Rated voltage: 500V Terminal: Screw terminal Wiregauge: 0.14-4.0mm ²		Tech Data	Rated current: 16A Rated voltage: 500V Terminal: Spring terminal Wiregauge: 0.5-2.5mm ²		Tech Data	Rated current: 16A Rated voltage: 500V Terminal: Crimp terminal Wiregauge: 0.14-4.0mm ²		Tech Data	Rated current: 16A Rated voltage: 500V Terminal: Spring terminal Wiregauge: 0.5-2.5mm ²	
Hoods & Housings	For H10B series see page 45-46		Hoods & Housings	For H10B series see page 45-46		Hoods & Housings	For H10B series see page 45-46		Hoods & Housings	For H10B series see page 45-46	

16+			16+			16+			16+			16+		
Screw Terminal						Spring Terminal			Crimp Terminal (Order crimp contacts separately)			Spring Terminal (Two terminals per contact)		
	Type	PN		Type	PN		Type	PN		Type	PN		Type	PN
Male (M)	HE-016-M	T2040162101-000	Male (M)	HE-016-MG	T2040162111-000	Male (M)	HE-016-MS	T2040163101-000	Male (M)	HE-016-MC	T2040164101-000	Male (M)	HE-016-MSS	T2040165101-000
Female (F)	HE-016-F	T2040162201-000	Female (F)	HE-016-FG	T2040162211-000	Female (F)	HE-016-FS	T2040163201-000	Female (F)	HE-016-FC	T2040164201-000	Female (F)	HE-016-FSS	T2040165201-000
Tech Data	Rated current: 16A Rated voltage: 500V Terminal: Screw terminal Wiregauge: 0.14-4.0mm ²		Tech Data	Rated current: 16A Rated voltage: 500V Terminal: Screw terminal Wiregauge: 0.14-4.0mm ²		Tech Data	Rated current: 16A Rated voltage: 500V Terminal: Spring terminal Wiregauge: 0.5-2.5mm ²		Tech Data	Rated current: 16A Rated voltage: 500V Terminal: Crimp terminal Wiregauge: 0.14-4.0mm ²		Tech Data	Rated current: 16A Rated voltage: 500V Terminal: Spring terminal Wiregauge: 0.5-2.5mm ²	
Hoods & Housings	For H16B series see page 47-48		Hoods & Housings	For H16B series see page 47-48		Hoods & Housings	For H16B series see page 47-48		Hoods & Housings	For H16B series see page 47-48		Hoods & Housings	For H16B series see page 47-48	







TE Connectivity's Heavy Duty Connectors







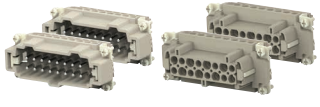
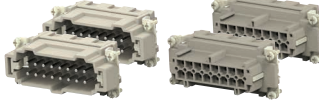

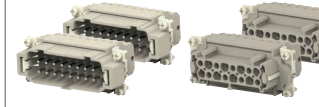
Inserts









HE Series

HE SERIES INSERTS CAN MATCH THE HB SERIES HOODS AND HOUSINGS. SEE PAGE 44 TO 52.

Inserts

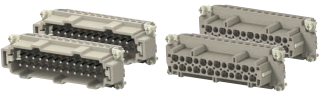
16+ 			16+ 			16+ 			16+ 		
Screw Terminal			Spring Terminal			Crimp Terminal (Order crimp contacts separately)			Spring Terminal (Two terminals per contact)		
											
	Type	PN		Type	PN		Type	PN		Type	PN
Male (M)	HE-016-M HE-016-M 17-32	T2040162101-000 T2040322101-000	Male (M)	HE-016-MS HE-016-MS 17-32	T2040163101-000 T2040323101-000	Male (M)	HE-016-MC HE-016-MC 17-32	T2040164101-000 T2040324101-000	Male (M)	HE-016-MSS HE-016-MSS 17-32	T2040165101-000 T2040325101-000
Female (F)	HE-016-F HE-016-F 17-32	T2040162201-000 T2040322201-000	Female (F)	HE-016-FS HE-016-FS 17-32	T2040163201-000 T2040323201-000	Female (F)	HE-016-FC HE-016-FC 17-32	T2040164201-000 T2040324201-000	Female (F)	HE-016-FSS HE-016-FSS 17-32	T2040165201-000 T2040325201-000
Tech Data	Rated current: 16A Rated voltage: 500V Terminal: Screw terminal Wiregauge: 0.14-4.0mm ²		Tech Data	Rated current: 16A Rated voltage: 500V Terminal: Spring terminal Wiregauge: 0.5-2.5mm ²		Tech Data	Rated current: 16A Rated voltage: 500V Terminal: Crimp terminal Wiregauge: 0.14-4.0mm ²		Tech Data	Rated current: 16A Rated voltage: 500V Terminal: Spring terminal Wiregauge: 0.5-2.5mm ²	
Hoods & Housings	For H16B series see page 47-48		Hoods & Housings	For H16B series see page 47-48		Hoods & Housings	For H16B series see page 47-48		Hoods & Housings	For H16B series see page 47-48	

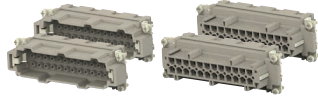
24+ 			24+ 			24+ 			24+ 		
Screw Terminal			Spring Terminal			Crimp Terminal (Order crimp contacts separately)			Spring Terminal (Two terminals per contact)		
											
	Type	PN		Type	PN		Type	PN		Type	PN
Male (M)	HE-024-M	T2040242101-000	Male (M)	HE-024-MS	T2040243101-000	Male (M)	HE-024-MC	T2040244101-000	Male (M)	HE-024-MSS	T2040245101-000
Female (F)	HE-024-F	T2040242201-000	Female (F)	HE-024-FS	T2040243201-000	Female (F)	HE-024-FC	T2040244201-000	Female (F)	HE-024-FSS	T2040245201-000
Tech Data	Rated current: 16A Rated voltage: 500V Terminal: Screw terminal Wiregauge: 0.14-4.0mm ²		Tech Data	Rated current: 16A Rated voltage: 500V Terminal: Spring terminal Wiregauge: 0.5-2.5mm ²		Tech Data	Rated current: 16A Rated voltage: 500V Terminal: Crimp terminal Wiregauge: 0.14-4.0mm ²		Tech Data	Rated current: 16A Rated voltage: 500V Terminal: Spring terminal Wiregauge: 0.5-2.5mm ²	
Hoods & Housings	For H24B series see page 49-50		Hoods & Housings	For H24B series see page 49-50		Hoods & Housings	For H24B series see page 49-50		Hoods & Housings	For H24B series see page 49-50	









48+ 			48+ 			48+ 			48+ 		
Screw Terminal			Spring Terminal			Crimp Terminal (Order crimp contacts separately)			Spring Terminal (Two terminals per contact)		
											
	Type	PN		Type	PN		Type	PN		Type	PN
Male (M)	HE-024-M HE-024-M 25-48	T2040242101-000 T2040482101-000	Male (M)	HE-024-MS HE-024-MS 25-48	T2040243101-000 T2040483101-000	Male (M)	HE-024-MC HE-024-MC 25-48	T2040244101-000 T2040484101-000	Male (M)	HE-024-MSS HE-024-MSS 25-48	T2040245101-000 T2040485101-000
Female (F)	HE-024-F HE-024-F 25-48	T2040242201-000 T2040482201-000	Female (F)	HE-024-FS HE-024-FS 25-48	T2040243201-000 T2040483201-000	Female (F)	HE-024-FC HE-024-FC 25-48	T2040244201-000 T2040484201-000	Female (F)	HE-024-FSS HE-024-FSS 25-48	T2040245201-000 T2040485201-000
Tech Data	Rated current: 16A Rated voltage: 500V Terminal: Screw terminal Wiregauge: 0.14-4.0mm ²		Tech Data	Rated current: 16A Rated voltage: 500V Terminal: Spring terminal Wiregauge: 0.5-2.5mm ²		Tech Data	Rated current: 16A Rated voltage: 500V Terminal: Crimp terminal Wiregauge: 0.14-4.0mm ²		Tech Data	Rated current: 16A Rated voltage: 500V Terminal: Spring terminal Wiregauge: 0.5-2.5mm ²	
Hoods & Housings	For H24B series see page 49-50		Hoods & Housings	For H24B series see page 49-50		Hoods & Housings	For H24B series see page 49-50		Hoods & Housings	For H24B series see page 49-50	





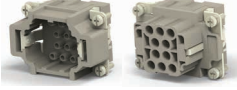

TE Connectivity's Heavy Duty Connectors

Inserts

HEE Series

HEE SERIES INSERTS CAN MATCH THE HB SERIES HOODS AND HOUSINGS. SEE PAGE 44 TO 52.

10+ 			15+ 			18+ 			32+ 		
Crimp Terminal (Order crimp contacts separately)			Crimp Terminal (Order crimp contacts separately)			Crimp Terminal (Order crimp contacts separately)			Crimp Terminal (Order crimp contacts separately)		
											
	Type	PN		Type	PN		Type	PN		Type	PN
Male (M)	HEE-010-M	T2050102101-000	Male (M)	HEE-015-M	T2800152101-000	Male (M)	HEE-018-M	T2050182101-000	Male (M)	HEE-032-M	T2050322101-000
Female (F)	HEE-010-F	T2050102201-000	Female (F)	HEE-015-F	T2800152201-000	Female (F)	HEE-018-F	T2050182201-000	Female (F)	HEE-032-F	T2050322201-000
Tech Data	Rated current:16A Rated voltage :500V Wiregauge:0.14-4.0mm ²		Tech Data	Rated current:16A Rated voltage :500V Wiregauge:0.14-4.0mm ²		Tech Data	Rated current:16A Rated voltage :500V Wiregauge:0.14-4.0mm ²		Tech Data	Rated current:16A Rated voltage :500V Wiregauge:0.14-4.0mm ²	
Hoods & Housings	For H6B series see page 44		Hoods & Housings	For H6B series see page 44		Hoods & Housings	For H10B series see page 45-46		Hoods & Housings	For H16B series see page 47-48	

46+ 			64+ 			92+ 		
Crimp Terminal (Order crimp contacts separately)			Crimp Terminal (Order crimp contacts separately)			Crimp Terminal (Order crimp contacts separately)		
								
	Type	PN		Type	PN		Type	PN
Male (M)	HEE-046-M	T2050462101-000	Male (M)	HEE-032-M HEE-032-M 33-64	T2050322101-000 T2050642101-000	Male (M)	HEE-046-M HEE-046-M 47-92	T2050462101-000 T2050922101-000
Female (F)	HEE-046-F	T2050462201-000	Female (F)	HEE-032-F HEE-032-F 33-64	T2050322201-000 T2050642201-000	Female (F)	HEE-046-F HEE-046-F 47-92	T2050462201-000 T2050922201-000
Tech Data	Rated current:16A Rated voltage :500V Wiregauge:0.14-4.0mm ²		Tech Data	Rated current:16A Rated voltage :500V Wiregauge:0.14-4.0mm ²		Tech Data	Rated current:16A Rated voltage :500V Wiregauge:0.14-4.0mm ²	
Hoods & Housings	For H24B series see page 49-50		Hoods & Housings	For H32B series see page 51		Hoods & Housings	For H48B series see page 52	

Inserts

HEEE Series

HEEE SERIES INSERTS CAN MATCH THE HB SERIES HOODS AND HOUSINGS. SEE PAGE 44 TO 52.

20+ 			32+ 			40+ 			48+ 		
Crimp Terminal			Crimp Terminal			Crimp Terminal			Crimp Terminal		
											
	Type	PN		Type	PN		Type	PN		Type	PN
Male (M)	HEEE-020-M	T2050202101-000	Male (M)	HEEE-032-M	T2050323101-000	Male (M)	HEEE-040-M	T2050402101-000	Male (M)	HEEE-048-M	T2050482101-000
Female (F)	HEEE-020-F	T2050202201-000	Female (F)	HEEE-032-F	T2050323201-000	Female (F)	HEEE-040-F	T2050402201-000	Female (F)	HEEE-048-F	T2050482201-000
Tech Data	Rated current: 16A Rated voltage: 400V Wiregauge: 0.14-4.0mm ²		Tech Data	Rated current: 16A Rated voltage: 400V Wiregauge: 0.14-4.0mm ²		Tech Data	Rated current: 16A Rated voltage: 500V Wiregauge: 0.14-4.0mm ²		Tech Data	Rated current: 16A Rated voltage: 400V Wiregauge: 0.14-4.0mm ²	
Hoods & Housings	For HB series see page 44-52		Hoods & Housings	For HB series see page 44-52		Hoods & Housings	For HB series see page 44-52		Hoods & Housings	For HB series see page 44-52	

64+ 			72+ 			80+ 		
Crimp Terminal			Crimp Terminal			Crimp Terminal		
								
	Type	PN		Type	PN		Type	PN
Male (M)	HEEE-064-M	T2050643101-000	Male (M)	HEEE-072-M	T2050722101-000	Male (M)	HEEE-040-M HEEE-040-M 41-80	T2050402101-000 T2050802101-000
Female (F)	HEEE-064-F	T2050643201-000	Female (F)	HEEE-072-F	T2050722201-000	Female (F)	HEEE-040-F HEEE-040-F 41-80	T2050402201-000 T2050802201-000
Tech Data	Rated current: 16A Rated voltage: 500V Wiregauge: 0.14-4.0mm ²		Tech Data	Rated current: 16A Rated voltage: 400V Wiregauge: 0.14-4.0mm ²		Tech Data	Rated current: 16A Rated voltage: 500V Wiregauge: 0.14-4.0mm ²	
Hoods & Housings	For HB series see page 44-52		Hoods & Housings	For HB series see page 44-52		Hoods & Housings	For HB series see page 44-52	



96+ 			128+ 			144+ 		
Crimp Terminal			Crimp Terminal			Crimp Terminal		
								
	Type	PN		Type	PN		Type	PN
Male (M)	HEEE-048-M HEEE-048-M 49-96	T2050482101-000 T2050962101-000	Male (M)	HEEE-064-M HEEE-064-M 65-128	T2050643101-000 T2051283101-000	Male (M)	HEEE-072-M HEEE-072-M 73-144	T2050722101-000 T2051442101-000
Female (F)	HEEE-048-F HEEE-048-F 49-96	T2050482201-000 T2050962201-000	Female (F)	HEEE-064-F HEEE-064-F 65-128	T2050643201-000 T2051283201-000	Female (F)	HEEE-072-F HEEE-072-F 73-144	T2050722201-000 T2051442201-000
Tech Data	Rated current: 16A Rated voltage: 400V Wiregauge: 0.14-4.0mm ²		Tech Data	Rated current: 16A Rated voltage: 500V Wiregauge: 0.14-4.0mm ²		Tech Data	Rated current: 16A Rated voltage: 400V Wiregauge: 0.14-4.0mm ²	
Hoods & Housings	For HB series see page 44-52		Hoods & Housings	For HB series see page 44-52		Hoods & Housings	For HB series see page 44-52	

TE Connectivity's Heavy Duty Connectors

Inserts

HVE Series

HVE SERIES INSERTS CAN MATCH THE HB SERIES HOODS AND HOUSINGS. SEE PAGE 44 TO 52.

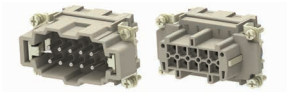
3+⊕+2 additional contacts for safe high voltage connections			10+⊕+2 additional contacts for safe high voltage connections			3+⊕+2 additional contacts for safe high voltage connections		
Screw Terminal			Screw Terminal			Spring Terminal		
								
	Type	PN		Type	PN		Type	PN
Male (M)	HVE-003-M	T2300033101-000	Male (M)	HVE-010-M	T2300103101-000	Male (M)	HVES-003-M	T2300032101-000
Female (F)	HVE-003-F	T2300033201-000	Female (F)	HVE-010-F	T2300103201-000	Female (F)	HVES-003-F	T2300032201-000
Tech Data	Rated current: 16A Rated voltage: 830V Wiregauge: 0.5-2.5mm ²		Tech Data	Rated current: 16A Rated voltage: 830V Wiregauge: 0.5-2.5mm ²		Tech Data	Rated current: 16A Rated voltage: 830V Wiregauge: 0.5-2.5mm ²	
Hoods & Housings	For H10B series see page 45-46		Hoods & Housings	For H24B series see page 49-50		Hoods & Housings	For H10B series see page 45-46	

10+⊕+2 additional contacts for safe high voltage connections			10+⊕+2 additional contacts for safe high voltage connections		
Spring Terminal			Crimp Terminal		
					
	Type	PN		Type	PN
Male (M)	HVES-010-M	T2300102101-000	Male (M)	HVEC-010-M	T2300104101-000
Female (F)	HVES-010-F	T2300102201-000	Female (F)	HVEC-010-F	T2300104201-000
Tech Data	Rated current: 16A Rated voltage: 830V Wiregauge: 0.5-2.5mm ²		Tech Data	Rated current: 16A Rated voltage: 830V Wiregauge: 0.5-4.0 mm ²	
Hoods & Housings	For H24B series see page 49-50		Hoods & Housings	For H24B series see page 49-50	

Inserts





TE Connectivity's Heavy Duty Connectors

Inserts

HD Series

HD SERIES INSERTS CAN MATCH THE HA AND HB SERIES HOODS AND HOUSINGS. SEE PAGE 41 TO 52.

Inserts

7+ 			8			15+ 		
Crimp Terminal (Order crimp contacts separately)			Crimp Terminal (Order crimp contacts separately)			Crimp Terminal (Order crimp contacts separately)		
								
Type	PN		Type	PN		Type	PN	
Male (M)	HD-007-M	T2020072101-000	Male (M)	HD-008-M	T2020082101-000	Male (M)	HD-015-M	T2020152101-000
Female (F)	HD-007-F	T2020072201-000	Female (F)	HD-008-F	T2020082201-000	Female (F)	HD-015-F	T2020152201-000
Tech Data	Rated current: 10A Rated voltage: 250V Wiregauge: 0.14-2.5mm ²		Tech Data	Rated current: 10A Rated voltage: 50V Wiregauge: 0.14-2.5mm ²		Tech Data	Rated current: 10A Rated voltage: 250V Wiregauge: 0.14-2.5mm ²	
Hoods & Housings	For H3A series see page 41		Hoods & Housings	For H3A series see page 41		Hoods & Housings	For H10A series see page 42	

15+ 			25+ 			25+ 		
Rolled contacts (Order Rolled contacts separately)			Crimp Terminal (Order crimp contacts separately)			Rolled contacts (Order Rolled contacts separately)		
								
Type	PN		Type	PN		Type	PN	
Male (M)	HD-015-M	T2020152101-000	Male (M)	HD-025-M	T2020252101-000	Male (M)	HD-025-M	T2020252101-000
Female (F)	HD-015-FJ	T2020153201-000	Female (F)	HD-025-F	T2020252201-000	Female (F)	HD-025-FJ	T2020253201-000
Tech Data	Rated current: 10A Rated voltage: 250V Wiregauge: 0.14-2.5mm ²		Tech Data	Rated current: 10A Rated voltage: 250V Wiregauge: 0.14-2.5mm ²		Tech Data	Rated current: 10A Rated voltage: 250V Wiregauge: 0.14-2.5mm ²	
Hoods & Housings	For H10A series see page 42		Hoods & Housings	For H16A series see page 42		Hoods & Housings	For H16A series see page 42	

40+ 			40+ 			50+ 		
Crimp Terminal (Order crimp contacts separately)			Rolled contacts (Order Rolled contacts separately)			Crimp Terminal (Order crimp contacts separately)		
								
Type	PN		Type	PN		Type	PN	
Male (M)	HD-040-M	T2020402101-000	Male (M)	HD-040-M	T2020402101-000	Male (M)	HD-025-M HD-025-M 25-50	T2020252101-000 T2020502101-000
Female (F)	HD-040-F	T2020402201-000	Female (F)	HD-040-FJ	T2020403201-000	Female (F)	HD-025-F HD-025-F 25-50	T2020252201-000 T2020502201-000
Tech Data	Rated current: 10A Rated voltage: 250V Wiregauge: 0.14-2.5mm ²		Tech Data	Rated current: 10A Rated voltage: 250V Wiregauge: 0.14-2.5mm ²		Tech Data	Rated current: 10A Rated voltage: 250V Wiregauge: 0.14-2.5mm ²	
Hoods & Housings	For H16B series see page 47-48		Hoods & Housings	For H16B series see page 47-48		Hoods & Housings	For H24B series see page 49-50	

TE Connectivity's Heavy Duty Connectors

Inserts

HD Series

HD SERIES INSERTS CAN MATCH THE HB SERIES HOODS AND HOUSINGS. SEE PAGE 44 TO 52.

64+

Crimp Terminal (Order crimp contacts separately)



	Type	PN
Male (M)	HD-064-M	T2020642101-000
Female (F)	HD-064-F	T2020642201-000
Tech Data	Rated current: 10A Rated voltage: 250V Wiregauge: 0.14-2.5mm ²	
Hoods & Housings	For H24B series, see page 49-50	

64+

Rolled contacts (Order Rolled contacts separately)



	Type	PN
Male (M)	HD-064-M	T2020642101-000
Female (F)	HD-064-FJ	T2020643201-000
Tech Data	Rated current: 10A Rated voltage: 250V Wiregauge: 0.14-2.5mm ²	
Hoods & Housings	For H24B series, see page 49-50	

80+

Crimp Terminal (Order crimp contacts separately)

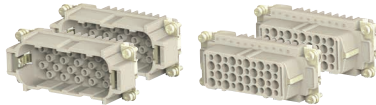

	Type	PN
Male (M)	HD-040-M	T2020402101-000
	HD-040-M 41-80	T2020802101-000
Female (F)	HD-040-F	T2020402201-000
	HD-040-F 41-80	T2020802201-000
Tech Data	Rated current: 10A Rated voltage: 250V Wiregauge: 0.14-2.5mm ²	
Hoods & Housings	For H16B series, see page 47-48	

80+

Rolled contacts (Order Rolled contacts separately)

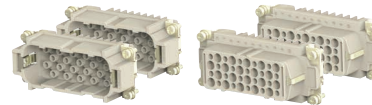

	Type	PN
Male (M)	HD-040-M	T2020402101-000
	HD-040-M 41-80	T2020802101-000
Female (F)	HD-040-FJ	T2020403201-000
	HD-040-FJ 41-80	T2020802201-100
Tech Data	Rated current: 10A Rated voltage: 250V Wiregauge: 0.14-2.5mm ²	
Hoods & Housings	For H16B series, see page 47-48	

128+

Crimp Terminal (Order crimp contacts separately)

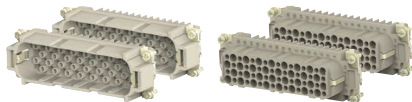

	Type	PN
Male (M)	HD-064-M	T2020642101-000
	HD-064-M 65-128	T2021282101-000
Female (F)	HD-064-F	T2020642201-000
	HD-064-F 65-128	T2021282101-000
Tech Data	Rated current: 10A Rated voltage: 250V Wiregauge: 0.14-2.5mm ²	
Hoods & Housings	For H24B series, see page 49-50	

128+

Rolled contacts (Order Rolled contacts separately)

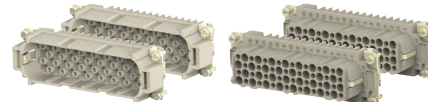



	Type	PN
Male (M)	HD-064-M	T2020642101-000
	HD-064-M 65-128	T2021282201-000
Female (F)	HD-064-FJ	T2020643201-000
	HD-064-FJ 65-128	T2021282201-100
Tech Data	Rated current: 10A Rated voltage: 250V Wiregauge: 0.14-2.5mm ²	
Hoods & Housings	For H24B series, see page 49-50	

HDD Series

HDD SERIES INSERTS CAN MATCH THE HB SERIES HOODS AND HOUSINGS. SEE PAGE 44 TO 52.

16+ 			24+ 			24+ 		
Crimp Terminal (Order crimp contacts separately)			Crimp Terminal (Order crimp contacts separately)			Rolled contacts (Order Rolled contacts separately)		
								
	Type	PN		Type	PN		Type	PN
Male (M)	HDD-016-M	T2030162101-000	Male (M)	HDD-024-M	T2030242101-000	Male (M)	HDD-024-M	T2030242101-000
Female (F)	HDD-016-F	T2030162201-000	Female (F)	HDD-024-F	T2030242201-000	Female (F)	HDD-024-FJ	T2030243201-000
Tech Data	Rated current: 10A Rated voltage: 250V Wiregauge: 0.14-2.5mm ²		Tech Data	Rated current: 10A Rated voltage: 250V Wiregauge: 0.14-2.5mm ²		Tech Data	Rated current: 10A Rated voltage: 250V Wiregauge: 0.14-2.5mm ²	
Hoods & Housings	For H6B series see page 44		Hoods & Housings	For H6B series see page 44		Hoods & Housings	For H6B series see page 44	

42+ 			42+ 			72+ 		
Crimp Terminal (Order crimp contacts separately)			Rolled contacts (Order Rolled contacts separately)			Crimp Terminal (Order crimp contacts separately)		
								
	Type	PN		Type	PN		Type	PN
Male (M)	HDD-042-M	T2030422101-000	Male (M)	HDD-042-M	T2030422101-000	Male (M)	HDD-072-M	T2030722101-000
Female (F)	HDD-042-F	T2030422201-000	Female (F)	HDD-042-FJ	T2030423201-000	Female (F)	HDD-072-F	T2030722201-000
Tech Data	Rated current: 10A Rated voltage: 250V Wiregauge: 0.14-2.5mm ²		Tech Data	Rated current: 10A Rated voltage: 250V Wiregauge: 0.14-2.5mm ²		Tech Data	Rated current: 10A Rated voltage: 250V Wiregauge: 0.14-2.5mm ²	
Hoods & Housings	For H10B series see page 45-46		Hoods & Housings	For H10B series see page 45-46		Hoods & Housings	For H16B series see page 47-48	

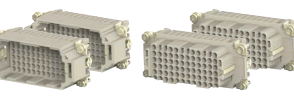
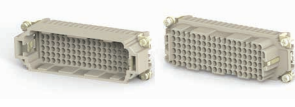
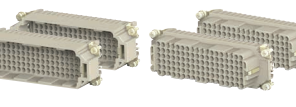
144+ 			108+ 			216+ 		
Crimp Terminal (Order crimp contacts separately)			Crimp Terminal (Order crimp contacts separately)			Crimp Terminal (Order crimp contacts separately)		
								
	Type	PN		Type	PN		Type	PN
Male (M)	HDD-072-M HDD-072-M 73-144	T2030722101-000 T2031442101-000	Male (M)	HDD-108-M	T2031082101-000	Male (M)	HDD-108-M HDD-108-M 109-216	T2031082101-000 T2032162101-000
Female (F)	HDD-072-F HDD-072-F 73-144	T2030722201-000 T2031442201-000	Female (F)	HDD-108-F	T2031082201-000	Female (F)	HDD-108-F HDD-108-F 109-216	T2031082201-000 T2032162201-000
Tech Data	Rated current: 10A Rated voltage: 250V Wiregauge: 0.14-2.5mm ²		Tech Data	Rated current: 10A Rated voltage: 250V Wiregauge: 0.14-2.5mm ²		Tech Data	Rated current: 10A Rated voltage: 250V Wiregauge: 0.14-2.5mm ²	
Hoods & Housings	For H32B series see page 51		Hoods & Housings	For H24B series see page 49-50		Hoods & Housings	For H48B series see page 52	

TE Connectivity's Heavy Duty Connectors

Inserts

HQ Series & HSB Series

HQ SERIES INSERTS CAN MATCH THE HA SERIES HOODS AND HOUSINGS. SEE PAGE 41 TO 43.

HSB SERIES INSERTS CAN MATCH THE HA SERIES HOODS AND HOUSINGS. SEE PAGE 41 TO 43.

2+			2+			5+			7+		
Crimp Terminal (Order crimp contacts separately)			Crimp Terminal (Order crimp contacts separately)			Crimp Terminal (Order crimp contacts separately)			Crimp Terminal (Order crimp contacts separately)		
Type	PN		Type	PN		Type	PN		Type	PN	
Male (M)	HQ-002-M	T2080022101-000	Male (M)	HQ-002-PM	T2080023101-000	Male (M)	HQ-005-M	T2080052101-000	Male (M)	HQ-007-M	T2080072101-000
Female (F)	HQ-002-F	T2080022201-000	Female (F)	HQ-002-PF	T2080023201-000	Female (F)	HQ-005-F	T2080052201-000	Female (F)	HQ-007-F	T2080072201-000
Tech Data	Rated current: 40A Rated voltage: 400V Wiregauge: 1-10mm ²		Tech Data	Rated current: 40A Rated voltage: 830V Wiregauge: 1-10mm ²		Tech Data	Rated current: 16A Rated voltage: 400V Wiregauge: 0.5-4.0mm ²		Tech Data	Rated current: 10A Rated voltage: 400V Wiregauge: 0.5-2.5mm ²	
Hoods & Housings	For H3A series see page 41		Hoods & Housings	For H3A series see page 41		Hoods & Housings	For H3A series see page 41		Hoods & Housings	For H3A series see page 41	

8+			12+			17+			4/2+		
Crimp Terminal (Order crimp contacts separately)			Crimp Terminal (Order crimp contacts separately)			Crimp Terminal (Order crimp contacts separately)			Crimp Terminal (Order crimp contacts separately)		
Type	PN		Type	PN		Type	PN		Type	PN	
Male (M)	HQ-008-M	T2019092101-000	Male (M)	HQ-012-M	T2080122101-000	Male (M)	HQ-017-M	T2080172101-000	Male (M)	HQ-4/2-M	T2080062101-001
Female (F)	HQ-008-F	T2019092201-000	Female (F)	HQ-012-F	T2080122201-000	Female (F)	HQ-017-F	T2080172201-000	Female (F)	HQ-4/2-F	T2080062201-001
Tech Data	Rated current: 10A Rated voltage: 500V Wiregauge: 0.5-4.0mm ²		Tech Data	Rated current: 10A Rated voltage: 400V Wiregauge: 0.5-2.5mm ²		Tech Data	Rated current: 10A Rated voltage: 250V Wiregauge: 0.5-2.5mm ²		Tech Data	Rated current: 40A/10A Rated voltage: 250V, 400V Wiregauge: 1.5-10mm ² /0.5-2.5mm ²	
Hoods & Housings	For H8A series see page 42		Hoods & Housings	For H3A series see page 41		Hoods & Housings	For H8A series see page 42		Hoods & Housings	For H8A series see page 42	

6+			12+		
Screw Terminal			Screw Terminal		
Type	PN		Type	PN	
Male (M)	HSB-006-M	T2060062101-000	Male (M)	HSB-006-M HSB-006-M 7-12	T2060062101-000 T2060122101-000
Female (F)	HSB-006-F	T2060062201-000	Female (F)	HSB-006-F HSB-006-F 7-12	T2060062201-000 T2060122201-000
Tech Data	Rated current: 35A Rated voltage: 690V Wiregauge: 0.5-6.0mm ²		Tech Data	Rated current: 35A Rated voltage: 690V Wiregauge: 0.5-6.0mm ²	
Hoods & Housings	For H16B series, see page 42		Hoods & Housings	For H32B series, see page 43	

HEAV Series

HEAV SERIES INSERTS CAN MATCH THE HB SERIES HOODS AND HOUSINGS. SEE PAGE 44 TO 52.

6+

Spring Terminal

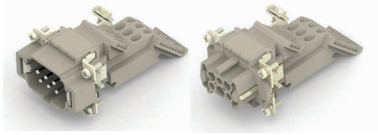

	Type	PN
Male (M)	HEAV-006-MS	T2100063101-000
Female (F)	HEAV-006-FS	T2100063201-000
Tech Data	Rated current: 16A Rated voltage: 500V Wiregauge: 0.2-2.5mm ²	
Hoods & Housings	For H6B series, see page 44	

10+

Spring Terminal

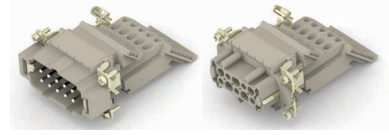

	Type	PN
Male (M)	HEAV-010-MS	T2100103101-000
Female (F)	HEAV-010-FS	T2100103201-000
Tech Data	Rated current: 16A Rated voltage: 500V Wiregauge: 0.2-2.5mm ²	
Hoods & Housings	For H10B series, see page 45-46	

16+

Spring Terminal

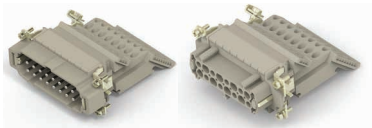

	Type	PN
Male (M)	HEAV-016-MS	T2100163101-000
Female (F)	HEAV-016-FS	T2100163201-000
Tech Data	Rated current: 16A Rated voltage: 500V Wiregauge: 0.2-2.5mm ²	
Hoods & Housings	For H16B series, see page 47-48	

24+

Spring Terminal

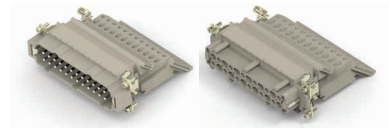

	Type	PN
Male (M)	HEAV-024-MS	T2100243101-000
Female (F)	HEAV-024-FS	T2100243201-000
Tech Data	Rated current: 16A Rated voltage: 500V Wiregauge: 0.2-2.5mm ²	
Hoods & Housings	For H24B series, see page 49-50	

TE Connectivity's Heavy Duty Connectors

Inserts

HK & HWK Series

HK SERIES INSERTS CAN MATCH THE HB SERIES HOODS AND HOUSINGS. SEE PAGE 44 TO 52.

HWK SERIES INSERTS CAN MATCH THE HB SERIES HOODS AND HOUSINGS. SEE PAGE 44 TO 52.

HK4/0+			HK4/2+			HK4/8+		
Screw Terminal			Screw Terminal			Screw Terminal		
								
	Type	PN		Type	PN		Type	PN
Male (M)	HK4/0-004-M	T2100042101-000	Male (M)	HK4/2-006-M	T2100062101-000	Male (M)	HK4/8-012-M	T2100122101-000
Female (F)	HK4/0-004-F	T2100042201-000	Female (F)	HK4/2-006-F	T2100062201-000	Female (F)	HK4/8-012-F	T2100122201-000
Tech Data	Rated current: 80A, 16A Rated voltage: 690V, 400V Wiregauge: 1.5-16.0mm ² , 0.5-2.5mm ²		Tech Data	Rated current: 80A,16A Rated voltage: 690V, 400V Wiregauge: 1.5-16.0mm ² , 0.5-2.5mm ²		Tech Data	Rated current: 80A, 16A Rated voltage: 400V, 400V Wiregauge: 1.5-16mm ² , 0.5-2.5mm ²	
Hoods & Housings	For H16B series see page 47-48		Hoods & Housings	For H16B series see page 47-48		Hoods & Housings	For H24B series see page 49-50	

HK8/24+			HK12/2+			HK6/36+		
Crimp Terminal (Order crimp contacts separately)			Crimp Terminal (Order crimp contacts separately)			Crimp Terminal (Order crimp contacts separately)		
								
	Type	PN		Type	PN		Type	PN
Male (M)	HK8/24-032-M	T2100322101-000	Male (M)	HK12/2-014-M	T2120142101-000	Male (M)	HK6/36-042-M	T2120422101-000
Female (F)	HK8/24-032-F	T2100322201-000	Female (F)	HK12/2-014-F	T2120142201-000	Female (F)	HK6/36-042-F	T2120422201-000
Tech Data	Rated current: 16A, 10A Rated voltage: 400V, 250V Wiregauge: 0.5-4.0mm ² , 0.14-2.5mm ²		Tech Data	Rated current: 40A, 10A Rated voltage: 690V, 250V Wiregauge: 1.5-16.0mm ² , 0.14-2.5mm ²		Tech Data	Rated current: 40A, 10A Rated voltage: 690V, 250V Wiregauge: 1.5-6.0mm ² , 0.14-2.5mm ²	
Hoods & Housings	For H10B series see page 45-46		Hoods & Housings	For H16B series see page 47-48		Hoods & Housings	For H16B series see page 47-48	

HWK3/6/6+			HWK6/6+		
Screw Terminal			Screw Terminal		
					
	Type	PN		Type	PN
Male (M)	HWK3/3/6-012-M	T2093362101-000	Male (M)	HWK6/6-012-M	T2106062101-000
Female (F)	HWK3/3/6-012-F	T2093362201-000	Female (F)	HWK6/6-012-F	T2106062201-000
Tech Data	Rated current: 35A, 40A, 16A Rated voltage: 690V, 400V, 250V Wiregauge: 16-35mm ² , 2.5-6mm ² , 0.5-2.5mm ² ,		Tech Data	Rated current: 35A, 16A Rated voltage: 690V, 400V Wiregauge: 4.0-10.0mm ² , 1.0-2.5mm ²	
Hoods & Housings	For H24B series, see page 49-50		Hoods & Housings	For H16B series, see page 47-48	

Special Inserts

Type	PN	Product Image	Terminal Type	Tech Data
HSC-10-M	T2800102101-000		Screw	10 poles single row connector Rated current: 25A Rated voltage: 500V Contact surface: Silver plated Flammability acc.to UL94:V0
HSC-10-F	T2800102201-000			

HMN MODULAR CONNECTORS OVERVIEW

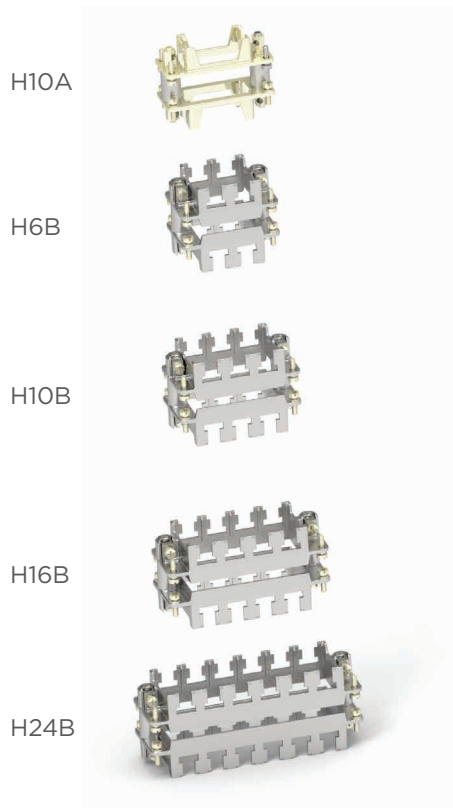

Modular units, install and remove without special tools!

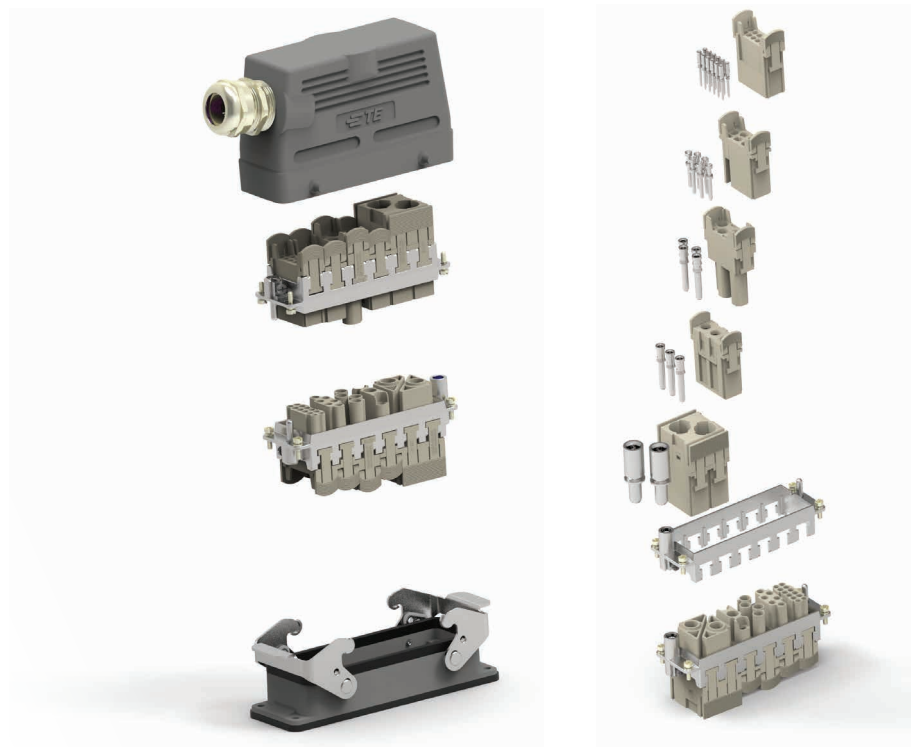

Inserts

HMN module fixing frame

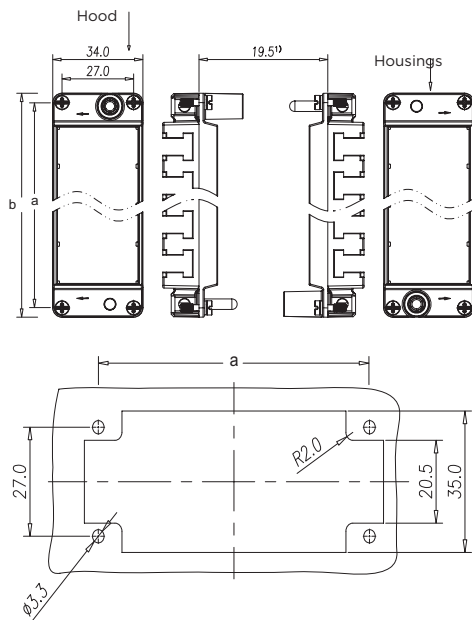

Distance for electrical contacts max.21mm
20.5mm/For pneumatic contacts max.20.5mm
Each frame is composed of an upper and a lower bracket.



Hood/ Housing Type	No. of Modules	a	b	Product	P/N
H24B	6	10.4	111	H24BN-T6-M-HD	T2070244101-002
				H24BN-T6-F-HD	T2070244201-002
H16B	4	77.5	84.5	H16BN-T4-M-HD	T2070164101-002
				H16BN-T4-F-HD	T2070164201-002
H10B	3	57	64.1	H10BN-T3-M-HD	T2070104101-002
				H10BN-T3-F-HD	T2070104201-002
H6B	2	44	51	H6BN-T2-M-HD	T2070064101-002
				H6BN-T2-F-HD	T2070064201-002
H10A	1	49.5	56.5	H10A-T1-M-HD	T2079104101-002
				H10A-T1-F-HD	T2079104201-002



HMN Series

HMN SERIES INSERTS CAN MATCH THE HA SERIES HOODS AND HOUSINGS. SEE PAGE 32 TO 34.

Inserts

1-pos			2-pos			2-pos		
Crimp Terminal (Order crimp contacts separately)			Crimp Terminal (Order crimp contacts separately)			Crimp Terminal (Order crimp contacts separately)		
								
	Type	PN		Type	PN		Type	PN
	HMN-001-MC	T2111013101-000	Male (M)	HMN-D2-MC	T2111028101-000	Male (M)	HMN-002-MC	T2111020101-000
	HMN-001-MC	T2111013201-000	Female (F)	HMN-D2-FC	T2111028201-000	Female (F)	HMN-002-FC	T2111020201-000
Tech Data	Rated current: 200A Rated voltage: 1000V Wiregauge: 25-70mm ²		Tech Data	Rated current: 100A Rated voltage: 1000V Wiregauge: 10-35mm ²		Tech Data	Rated current: 70A Rated voltage: 1000V Wiregauge: 10-25mm ²	

3-pos			4-pos			5-pos		
Crimp Terminal (Order crimp contacts separately)			Crimp Terminal (Order crimp contacts separately)			Spring Terminal		
								
	Type	PN		Type	PN		Type	PN
Male (M)	HMN-003-M	T2111032101-000	Male (M)	HMN-004-M	T2111042101-000	Male (M)	HMN-005-MS	T2110052101-000
Female (F)	HMN-003-F	T2111032201-000	Female (F)	HMN-004-F	T2111042201-000	Female (F)	HMN-005-FS	T2110052201-000
Tech Data	Rated current: 40A Rated voltage: 690V Wiregauge: 1.5-10mm ²		Tech Data	Rated current: 40A Rated voltage: 830V Wiregauge: 1.5-6.0mm ²		Tech Data	Rated current: 16A Rated voltage: 400V Wiregauge: 0.14-2.5mm ²	

6-pos			6-pos			8-pos		
Crimp Terminal (Order crimp contacts separately)			Crimp Terminal (Order crimp contacts separately)			Crimp Terminal (Order crimp contacts separately)		
								
	Type	PN		Type	PN		Type	PN
Male (M)	HMN-006-M	T2111062101-000	Male (M)	HMN-006-PM	T2111063101-000	Male (M)	HMN-008-MC	T2111020101-000
Female (F)	HMN-006-F	T2111062201-000	Female (F)	HMN-006-PF	T2111063201-000	Female (F)	HMN-008-FC	T2111020201-000
Tech Data	Rated current: 16A Rated voltage: 500V Wiregauge: 0.14-4.0mm ²		Tech Data	Rated current: 16A Rated voltage: 830V Wiregauge: 0.14-4.0mm ²		Tech Data	Rated current: 70A Rated voltage: 1000V Wiregauge: 10-25mm ²	





12-pos			17-pos			20-pos		
Crimp Terminal (Order crimp contacts separately)			Crimp Terminal (Order crimp contacts separately)			Crimp Terminal (Order crimp contacts separately)		
								
	Type	PN		Type	PN		Type	PN
Male (M)	HMN-012-M	T2111122101-000	Male (M)	HMN-017-M	T2111172101-000	Male (M)	HMN-020-M	T2111202101-000
Female (F)	HMN-012-F	T2111122201-000	Female (F)	HMN-017-F	T2111172201-000	Female (F)	HMN-020-F	T2111202201-000
Tech Data	Rated current: 10A Rated voltage: 250V Wiregauge: 0.14-2.5mm ²		Tech Data	Rated current: 10A Rated voltage: 160V Wiregauge: 0.14-2.5mm ²		Tech Data	Rated current: 16A Rated voltage: 500V Wiregauge: 0.14-4.0mm ²	

TE Connectivity's Heavy Duty Connectors



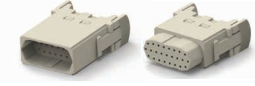

Modular Inserts

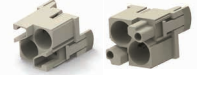

HMN Series

HMN SERIES INSERTS CAN MATCH THE HA SERIES HOODS AND HOUSINGS. SEE PAGE 32 TO 34.

25-pos			2 & 3-pos			Quintax 1 2-pos			Quintax 4 2-pos		
Crimp Terminal (Order crimp contacts separately)			Crimp Terminal (Order crimp contacts separately)			Crimp Terminal (Order crimp contacts separately)			Crimp Terminal (Order crimp contacts separately)		
											
	Type	PN		Type	PN		Type	PN		Type	PN
Male (M)	HMN-025-M	T2111252101-000	Male (M)	HMN-PA2	T2111022301-000	Male (M)	HMN-Q1-M	T2111027101-000	Male (M)	HMN-Q2-M	T2111027101-001
Female (F)	HMN-025-F	T2111252201-000	Female (F)	HMN-PA3	T2111032301-000	Female (F)	HMN-Q1-F	T2111027201-000	Female (F)	HMN-Q2-F	T2111027201-001
Tech Data	Rated current: 5A Rated voltage: 50V Wiregauge: 0.08-0.52mm ²		Tech Data	Rated current: 40A, 10A Rated voltage: 690V, 250V Wiregauge: 3mm ² , 4mm ² , 6mm ²		Tech Data	Rated current: 16A Rated voltage: 50V Wiregauge: 0.14-4MM2		Tech Data	Rated current: 10A Rated voltage: 50V Wiregauge: 0.14-4.0mm ²	

Pneu-c ø1.6			Pneu-c ø3.0			Pneu-c ø4.0			Pneu-c ø6.0		
											
	Type	PN		Type	PN		Type	PN		Type	PN
	Pneu-c ø1.6	T2090002101-001		Pneu-c ø3.0	T2090002101-002		Pneu-c ø4.0	T2090002101-003		Pneu-c ø6.0	T2090002101-004
	Pneu-c ø1.6	T2090002201-001		Pneu-c ø3.0	T2090002201-002		Pneu-c ø4.0	T2090002201-003		Pneu-c ø6.0	T2090002201-004

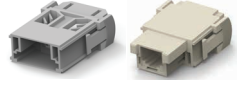
Quintax 8 2-pos											
Crimp Terminal (Order crimp contacts separately)			Crimp Terminal (Order crimp contacts separately)			Crimp Terminal (Order crimp contacts separately)			Crimp Terminal (Order crimp contacts separately)		
											
	Type	PN		Type	PN		Type	PN		Type	PN
Male (M)	HMN-Q3-M	T2111027101-002	Male (M)	QUINTAX 1-POS-M	T2580011154-000	Male (M)	QUINTAX 4-POS-M	T2580031154-000	Male (M)	QUINTAX 8-POS-M	T2580081154-000
Female (F)	HMN-Q3-F	T2111027201-002	Female (F)	QUINTAX 1-POS-F	T2580012154-000	Female (F)	QUINTAX 4-POS-F	T2580032154-000	Female (F)	QUINTAX 8-POS-F	T2580082154-000
Tech Data	Rated current: 5A Rated voltage: 50V Wiregauge: 0.14-4.0mm ²		Tech Data	Rated current: 16A Rated voltage: 50V Wiregauge: 0.5-4.0mm ²		Tech Data	Rated current: 10A Rated voltage: 50V Wiregauge: 0.14-2.5mm ²		Tech Data	Rated current: 5A Rated voltage: 50V Wiregauge: 0.08-0.52mm ²	

D-Sub			RJ45			Dummy Module Insert		
Crimp Terminal (Order crimp contacts separately)			Crimp Terminal (Order crimp contacts separately)					
								
	Type	PN		Type	PN		Type	PN
Male (M)	HMN-009-M	T2111092101-000	Male (M)	HMN-RJ45-M	T2113000101-000			
Female (F)	HMN-009-F	T2111092201-000	Female (F)	HMN-RJ45-F	T2113000201-000		HMN-DM	T3110009902-000
Tech Data	Rated current: 5A Rated voltage: 50V		Tech Data	Rated current: 1A Rated voltage: 50V Wiregauge: 0.89-0.99mm ² , 0.94-1.07mm ²		Tech Data	Rated current: 16A Rated voltage: 500V Wiregauge: 0.14-4.0mm ²	

HCM Series

PRODUCT OFFERING



Solution	Series	Components	PN	Description	Comments
1 Pos	HCM250	Hoods	T1920160125-000	H16BPR-TGH-M25	Depends on cable diameter
		Housings	T1930160000-000	H16BPR-AG	
		Female Inserts	T2192503201-000	HCM250-FC	Crimp terminal
		Male Inserts	T2192503101-000	HCM250-MC	Crimp terminal
		Frame	T0924028544-000	H16BRP-2P-250-FRAME	
		Female Contacts	T2192502035-000	HCM250-FC-35	Crimp area acc. to DIN EN 46 235
			T2192502050-000	HCM250-FC-50	Crimp area acc. to DIN EN 46 235
			T2192502070-000	HCM250-FC-70	Crimp area acc. to DIN EN 46 235
		Male Contacts	T2192501035-000	HCM250-MC-35	Crimp area acc. to DIN EN 46 235
			T2192501050-000	HCM250-MC-50	Crimp area acc. to DIN EN 46 235
	T2192501070-000		HCM250-MC-70	Crimp area acc. to DIN EN 46 235	
	HCM350	Hoods	T1920160125-000	H16BPR-TGH-M25	Depends on cable diameter
		Housings	T1930060000-000	H6BPR-AG	
		Female Inserts	T2193503201-000	HCM350-FC	Crimp terminal
		Male Inserts	T2193503101-000	HCM350-MC	Crimp terminal
		Frame	T0924015115-000	H6BPR-IP-350-FRAME	
		Female Contacts	T2193502035-000	HCM350-FC35	Crimp area acc. to DIN EN 46 235
			T2193502050-000	HCM350-FC-50	Crimp area acc. to DIN EN 46 235
			T2193502070-000	HCM350-FC-70	Crimp area acc. to DIN EN 46 235
			T2193502095-000	HCM350-FC-95	Crimp area acc. to DIN EN 46 235
T2193502120-000			HCM350-FC-120	Crimp area acc. to DIN EN 46 235	
Male Contacts	T2193501035-000	HCM350-MC-35	Crimp area acc. to DIN EN 46 235		
	T2193501050-000	HCM350-MC-50	Crimp area acc. to DIN EN 46 235		
	T2193501070-000	HCM350-MC-70	Crimp area acc. to DIN EN 46 235		
	T2193501095-000	HCM350-MC-95	Crimp area acc. to DIN EN 46 235		
	T2193501120-000	HCM350-MC-120	Crimp area acc. to DIN EN 46 235		

TE Connectivity's Heavy Duty Connectors

Modular Inserts

HCM Series

PRODUCT OFFERING

Solution	Series	Components	PN	Description	Comments
2 Pos	HCM250	Hoods	T1920160225-000	H16BPR-TGH-2M25	Depends on cable diameter
		Housings	T1930160000-000	H16BPR-AG	
		Female Inserts	T2192503201-000	HCM250-FC	Crimp terminal
		Male Inserts	T2192503101-000	HCM250-MC	Crimp terminal
		Frame	T0924028544-000	H16BRP-2P-250-FRAME	
		Female Contacts	T2192502035-000	HCM250-FC-35	Crimp area acc. to DIN EN 46 235
			T2192502050-000	HCM250-FC-50	Crimp area acc. to DIN EN 46 235
			T2192502070-000	HCM250-FC-70	Crimp area acc. to DIN EN 46 235
		Male Contacts	T2192501035-000	HCM250-MC-35	Crimp area acc. to DIN EN 46 235
			T2192501050-000	HCM250-MC-50	Crimp area acc. to DIN EN 46 235
			T2192501070-000	HCM250-MC-70	Crimp area acc. to DIN EN 46 235
		HCM350	Hoods	T1920160225-000	H16BPR-TGH-2M25
	Housings		T1930160000-000	H16BPR-AG	
	Female Inserts		T2193503201-000	HCM350-FC	Crimp terminal
	Male Inserts		T2193503101-000	HCM350-MC	Crimp terminal
	Frame		T0924027845-000	1-116BPR-2P-350-FRAME	
	Female Contacts		T2193502035-000	HCM350-FC-35	Crimp area acc. to DIN EN 46 235
			T2193502050-000	HCM350-FC-50	Crimp area acc. to DIN EN 46 235
			T2193502070-000	HCM350-FC-70	Crimp area acc. to DIN EN 46 235
			T2193502095-000	HCM350-FC-95	Crimp area acc. to DIN EN 46 235
			T2193502120-000	HCM350-FC-120	Crimp area acc. to DIN EN 46 235
	Male Contacts		T2193501035-000	HCM350-MC-35	Crimp area acc. to DIN EN 46 235
			T2193501050-000	HCM350-MC-50	Crimp area acc. to DIN EN 46 235
			T2193501070-000	HCM350-MC-70	Crimp area acc. to DIN EN 46 235
			T2193501095-000	HCM350-MC-95	Crimp area acc. to DIN EN 46 235
			T2193501120-000	HCM350-MC-120	Crimp area acc. to DIN EN 46 235
	HCM650	Hoods	T1920240332-409	H24BPR-TGH-XL-3M32- EMC-C	Anti-corrosion performance, 3xM32 threads
		Housings	T1930240000-409	H24BPR-AG-EMC-C	High anticorrosion performance
		Blind Plug	T3165320111-000	BLIND-32-M	Metal blind plug M32
		Female Inserts	T2196503201-000	HCM650-FC	Crimp terminal
Male Inserts		T2196503101-000	HCM650-MC	Crimp terminal	
Frame		T0924311125-000	H241312R-3P-650-RRAME	3 Positions Frame	
Female Contacts		T2196502070-001	HCM650-FC-70	Crimp area acc. to DIN EN 46 235	
		T2196502095-001	HCM650-FC-95	Crimp area acc. to DIN EN 46 235	
		T2196502120-001	HCM650-FC-120	Crimp area acc. to DIN EN 46 235	
		T2196502150-001	HCM650-FC-150	Crimp area acc. to DIN EN 46 235	
		T2196502185-001	HCM650-FC-185	Crimp area acc. to DIN EN 46 235	
Male Contacts		T2196501070-001	HCM650-MC-70	Crimp area acc. to DIN EN 46 235	
		T2196501095-001	FICM650-MC-95	Crimp area acc. to DIN EN 46 235	
	T2196501120-001	FICM650-MC-120	Crimp area acc. to DIN EN 46 235		
	T2196501150-001	FICM650-MC-150	Crimp area acc. to DIN EN 46 235		
	T2196501185-001	FICM650-MC-185	Crimp area acc. to DIN EN 46 235		

HCM Series

PRODUCT OFFERING

Solution	Series	Components	PN	Description	Comments
3 Pos	HCM250	Hoods	T1890240325-000	H24BPR-STH-3M25	Depends on cable diameter
		Housings	T1930240000-000	H24BPR-AG	
		Female Inserts	T2192503201-000	HCM250-FC	Crimp terminal
		Male Inserts	T2192503101-000	HCM250-MC	Crimp terminal
		Frame	T09240490444 00	H 24BPR-4P-250-M-FRAME	
			T0924049044-200	H24BPR-4P-250-F-FRAME	
		Female Contacts	T2192502035-000	HCM250-FC-35	Crimp area acc. to DIN EN 46 235
			T2192502050-000	HCM250-FC-50	Crimp area acc. to DIN EN 46 235
			T2192502070-000	HCM250-FC-70	Crimp area acc. to DIN EN 46 235
		Male Contacts	T2192501035-000	HCM250-MC-35	Crimp area acc. to DIN EN 46 235
			T2192501050-000	HCM250-MC-50	Crimp area acc. to DIN EN 46 235
			T2192501070-000	HCM250-MC-70	Crimp area acc. to DIN EN 46 235
	HCM350	Hoods	T1890240325-000	H24BPR-STH-3M25	Depends on cable diameter
		Housings	T1930240000-000	H24BPR-AG	
		Female Inserts	T2193503201-000	HCM350-FC	Crimp terminal
		Male Inserts	T2193503101-000	HCM350-MC	Crimp terminal
		Frame	T09243110444:00	H24BRP-3P-350-FRAME	
		Female Contacts	T2193502035-000	HCM350-FC-35	Crimp area acc. to DIN EN 46 235
			T2193502050-000	HCM350-FC-50	Crimp area acc. to DIN EN 46 235
			T2193502070-0C°	HCM350-FC-70	Crimp area acc. to DIN EN 46 235
			T2193502095-000	HCM350-FC-95	Crimp area acc. to DIN EN 46 235
			T2193502120-000	HCM350-FC-120	Crimp area acc. to DIN EN 46 235
		Male Contacts	T2193501035-000	HCM350-MC-35	Crimp area acc. to DIN EN 46 235
			T2193501050-000	HCM350-MC-50	Crimp area acc. to DIN EN 46 235
			T2193501070-000	HCM350-MC-70	Crimp area acc. to DIN EN 46 235
			T2193501095-000	HCM350-MC-95	Crimp area acc. to DIN EN 46 235
			T2193501120-000	HCM350-MC-120	Crimp area acc. to DIN EN 46 235
		HCM650	Hoods	T1920240332-409	H24BPR-TGH-XL-3M32-EMC-C
	Housings		T1930240000-409	H24BR-AG-EMC-C	High anticorrosion performance
	Mounting frame		T1990240001-001	H24BPR-FRAME	
	Female Inserts		T2196503201-000	HCM650-FC	Crimp terminal
	Male Inserts		T2196503101-000	HCM650-MC	Crimp terminal
	Frame		T0924311125-000	H24BPR-3P-650-RRAME	3 Positions Frame
	Female Contacts		T2196502070-001	HCM650-FC-70	Crimp area acc. to DIN EN 46 235
			T2196502095-001	HCM650-FC-95	Crimp area acc. to DIN EN 46 235
			T2196502120-001	HCM650-FC-120	Crimp area acc. to DIN EN 46 235
T2196502150-001			HCM650-FC-150	Crimp area acc. to DIN EN 46 235	
T2196502185-001			HCM650-FC-185	Crimp area acc. to DIN EN 46 235	
Male Contacts	T2196501070-001		HCM650-MC-70	Crimp area acc. to DIN EN 46 235	
	T2196501095-001		HCM650-MC-95	Crimp area acc. to DIN EN 46 235	
	T2196501120-001		HCM650-MC-120	Crimp area acc. to DIN EN 46 235	
	T2196501150-001	HCM650-MC-150	Crimp area acc. to DIN EN 46 235		
	T2196501185-001	HCM650-MC-185	Crimp area acc. to DIN EN 46 235		

Inserts

TE Connectivity's Heavy Duty Connectors

Modular Inserts







HCM Series

PRODUCT OFFERING





Solution	Series	Components	PN	Description	Comments	
4 Pos	HCM250	Hoods	T1920240425-002	H24EPR-TGH-XL-4M25	Depends on cable diameter	
		Housings	T1930240000-000	H24EPR-AG		
		Female Inserts	T2192503201-000	HCM250-FC	Crimp terminal	
		Male Inserts	T2192503101-000	HCM250-MC	Crimp terminal	
		Frame	T0924049044-100	H24BPR-4P-250-M-FRAME		
			T0924049044-200	H24EPR-4P-250-F-FRAME		
		Female Contacts	T2192502035-000	HCM250-FC-35	Crimp area acc. to DIN EN 46 235	
			T2192502050-000	HCM250-FC-50	Crimp area acc. to DIN EN 46 235	
			T2192502070-000	HCM250-FC-70	Crimp area acc. to DIN EN 46 235	
		Male Contacts	T2192501035-000	HCM250-MC-35	Crimp area acc. to DIN EN 46 235	
			T2192501050-000	HCM250-MC-50	Crimp area acc. to DIN EN 46 235	
			T2192501070-000	HCM250-MC-70	Crimp area acc. to DIN EN 46 235	
		HCM350	Hoods	T1926320163-001	H32BPR-TGXH-4S-M63	
			Housings	T1936320000-000	H32BPR-AG-45	
	Female Inserts		T2193503201-000	HCM350-FC	Crimp terminal	
	Male Inserts		T2193503101-000	HCM350-MC	Crimp terminal	
	Frame		T0924048581-000	H32BRP-4P-350-FRAME		
	Female Contacts		T2193502035-000	HCM350-FC35	Crimp area acc. to DIN EN 46 235	
			T2193502050-000	HCM350-FC-50	Crimp area acc. to DIN EN 46 235	
			T2193502070-000	HCM350-FC-70	Crimp area acc. to DIN EN 46 235	
			T2193502095-000	HCM350-FC-95	Crimp area acc. to DIN EN 46 235	
			T2193502120-000	HCM350-FC-120	Crimp area acc. to DIN EN 46 235	
	Male Contacts		T2193501035-000	HCM350-MC-35	Crimp area acc. to DIN EN 46 235	
T2193501050-000			HCM350-MC-50	Crimp area acc. to DIN EN 46 235		
T2193501070-000			HCM350-MC-70	Crimp area acc. to DIN EN 46 235		
T2193501095-000			HCM350-MC-95	Crimp area acc. to DIN EN 46 235		
T2193501120-000			HCM350-MC-120	Crimp area acc. to DIN EN 46 235		

TOOLS AND ACCESSORIES

Crimping tools and remove tools

<p>Crimp tool Wire range: 0.5-4.0mm² Used for HD, HDD, HEE contacts</p> 	<p>Crimp tool Wire range: 4.0-10.0mm² Used for 40A contacts</p> 
Type CRIMPBOX-0.5/4	Type CRIMPBOX-4.0/10.0
Part Number T3100000001-000	Part Number T3100001001-000
<p>Remove tools Used for HEE series remove tools</p> 	<p>Remove tools Used for HEEE series remove tools</p> 
Type REMOV-HEE	Type REMOV-HEEE
Part Number T3100000002-000	Part Number T3100000016-000
<p>Remove tools Used for HD/HDD series remove tools</p> 	<p>Remove tools Used for CMM/CMF series remove tools</p> 
Type REMOV-HD	Type REMOV-MM
Part Number T3100000003-000	Part Number T3100000013-000



Axial screw tool and crimping tool

<p>M3 screw driver Used for HA/HE inserts</p> 	<p>Tool Used for 100A inserts</p> 
Type SCREWD-M3	Type HEXA-D1
Part Number T3100000009-000	Part Number T3100000010-000
<p>Tool Used for 40A inserts</p> 	<p>Crimp tool Wire range: 10.0-120.0mm² Used for 200A contacts</p> 
Type HEXA-D2	Type CRIMPBOX-10./120
Part Number T3100000012-000	Part Number T3100001015-000



Contacts - 100A Series

	Tech Data	Product Image	Wire Gauge	ø	Stripping Length	Crimp Contacts, Silver-Plated	
						Type	PN
100A Contact	Material: Copper Contact resistance: $\leq 1\text{m}\Omega$ Terminal: Crimp Connection	Male 	10mm ²	4.3	19mm	CNM-10	T2050001010-000
			16mm ²	5.5	19mm	CNM-16	T2050001016-000
			25mm ²	7	19mm	CNM-25	T2050001025-000
			35mm ²	8.2	16mm	CNM-35	T2050001035-000
		Female 	10mm ²	4.3	19mm	CNF-10	T2050002010-000
			16mm ²	5.5	19mm	CNF-16	T2050002016-000
			25mm ²	7	19mm	CNF-25	T2050002025-000
			35mm ²	8.2	16mm	CNF-35	T2050002035-000
200A Contact	Material: Copper Contact resistance: $\leq 0.3\text{m}\Omega$ Terminal: Crimp Connection	Male 	25mm ²	7	22.5mm	CHM-25	T2060001025-000
			35mm ²	8.2	22.5mm	CHM-35	T2060001035-000
			50mm ²	10	22.5mm	CHM-50	T2060001050-000
			70mm ²	11.5	22.5mm	CHM-70	T2060001070-000
		Female 	25mm ²	7	22.5mm	CHF-25	T2060002025-000
			35mm ²	8.2	22.5mm	CHF-35	T2060002035-000
			50mm ²	10	22.5mm	CHF-50	T2060002050-000
			70mm ²	11.5	22.5mm	CHF-70	T2060002070-000

Contacts - 5A Series

	Tech Data	Product Image	Wire Gauge	ø	Stripping Length	Crimp Contacts, Silver-Plated		Crimp Contacts, Gold-Plated	
						Type	PN	Type	PN
5A Contact	Material: Copper Contact resistance: $\leq 1\text{m}\Omega$ Terminal: Crimp Connection	Male 	0.08-0.21mm ²	AWG 28-24	5.0mm	CAM-08	T2070001008-000	DAM-08	T2070011008-000
			0.13-0.33mm ²	AWG 26-22	5.0mm	CAM-13	T2070001013-000	DAM-13	T2070011013-000
			0.33-0.52mm ²	AWG 22-20	5.0mm	CAM-33	T2070001033-000	DAM-33	T2070011033-000
	Material: Copper Contact resistance: $\leq 1\text{m}\Omega$ Terminal: Crimp Connection	Female 	0.08-0.21mm ²	AWG 28-24	5.0mm	CAF-08	T2070002008-000	DAF-08	T2070012008-000
			0.13-0.33mm ²	AWG 26-22	5.0mm	CAF-13	T2070002013-000	DAF-13	T2070012013-000
			0.33-0.52mm ²	AWG 22-20	5.0mm	CAF-33	T2070002033-000	DAF-33	T2070012033-000









Compatible Adapter

PCB Adapter		
Type	PN	Product Image
PCB-adapter-EE	T2040000000-000	
CEF-adapter	T2030002000-000	

TE Connectivity's Heavy Duty Connectors

Insert Mounting Elements

Insert Mounting Elements

INSERT MOUNTING ELEMENT	Product Image	Set Order	Type	PN
		H6B Set	H6B-RAIL-SET	T1870062000-000
		H10B Set	H10B-RAIL-SET	T1870102000-000
		H16B Set	H16B-RAIL-SET	T1870162000-000
		H24B Set	H24B-RAIL-SET	T1870242000-000
		Top	H6B-RAIL-TOP	T1870062101-000
			H10B-RAIL-TOP	T1870102101-000
			H16B-RAIL-TOP	T1870162101-000
			H24B-RAIL-TOP	T1870242101-000
		Base	HB-RAIL-BASE	T1870002201-000
		HB Top	HB-LM-TOP	T1871002101-000
		HB Base	HB-PLM-PM-BASE	T1871002201-000

Set
Insert mounting with carrier element
Set include: Top and base frame

Insert Mounting
Elements

Coding Pin

Product Image	Materials	Type	PN
	Ordinary	CODING-PIN-M3	T0931003003-000
	Stainless Steel	CODING-PIN-M3-S	T0931103003-000
	Ordinary	CODING-PIN-M3-TM	T0931000423-000
	Ordinary	CODING-PIN-M3-TF	T0931006524-000
	Stainless Steel	CODING-PIN-M3-STM	T0932000423-000
	Stainless Steel	CODING-PIN-M3-STF	T0932006524-000

TE Connectivity's Heavy Duty Connectors

Hoods and Housings IP65

H3A Hoods and Housings

H3A INCLUDE METAL AND PLASTIC SHELLS.
LEVERS INCLUDE METAL, PLASTIC AND STAINLESS STEEL.

H3A metal Hoods and Housings	Product Image	Metr.	PG	PN	Thermoplastic Hoods and Housings	Product Image	Metr.	PG	Type	PN
Top Entry			PG11	T1329030111-000	Top Entry			PG11	H3A-TG-PG11	T1329031111-000
		M20		T1329030120-000			M20		H3A-TG-M20	T1329031120-000
Side Entry			PG11	T1319030111-000	Side Entry			PG11	H3A-TS-PG11	T1319031111-000
		M20		T1319030120-000			M20		H3A-TS-M20	T1319031120-000
Bulkhead Mounting-Bottom Entry		-		T1509030000-000	Bulkhead Mounting-Bottom Entry		-		H3A-AG	T1509031100-000
Bulkhead Mounting-Side Entry		-		T1549030000-000	Bulkhead Mounting-Side Entry		-		H3A-AGS	T1509031111-000
Surface Mounting-Side Entry			PG11	T1619030111-000	Surface Mounting-Side Entry			PG11	H3A-AGSV-PG11	T1619031111-000
		M16		T1619030116-000			M16		H3A-AGSV-M16	T1619031116-000
		M20		T1619030120-000			M20		H3A-AGSV-M20	T1619031120-000
Cable-to-Cable Hoods			PG11	T1739030111-000	Cable-to-Cable Hood			PG11	H3A-TGVB-PG11	T1739032111-000
		M20		T1739030120-000			M20		H3A-TGVB-M20	T1739032120-000
Protection covers for hoods (Thermoplastic)		Note: For mounted male insert and hood		T1010034100-000	Protection covers for Housings		Note: For mounted male insert and hood		H3A-KDBP (THERMOPLASTIC)	T1010034100-000
							H3A-KDBM (Metal)	T1010033100-000		

TE Connectivity's Heavy Duty Connectors

Hoods and Housings IP65

H8A Thermoplastic and H10A & H16A Metal Hoods and Housings

H10A metal Hoods & Housings	Product Image	Metr.	PG	Type	PN	H16A metal Hoods & Housings	Product Image	Metr.	PG	Type	PN	
Hoods: Side Entry		M20	PG16	H10A-TS-PG16	T1319100116-000	Hoods: Side Entry			PG11	H16A-TS-PG11	T1319160111-000	
				H10A-TS-M20	T1319100120-000				PG16	H16A-TS-PG16	T1319160116-000	
		M25	PG21	H10A-TS-PG21	T1319100121-000			M20	H16A-TS-M20	T1319160120-000		
				H10A-TS-M25	T1319100125-000		PG21	H16A-TS-PG21	T1319160121-000			
Hood: Top Entry		M20	PG13.5	H10A-TG-PG13.5	T1329100113-000		Hoods: Top Entry			M25	H16A-TS-M25	T1319160125-000
				H10A-TG-PG16	T1329100116-000						PG11	H16A-TSH-PG11
		M25	PG21	H10A-TG-PG21	T1329100121-000				PG16	H16A-TSH-PG16	T1339160116-000	
				H10A-TG-M20	T1329100120-000			M20	H16A-TSH-M20	T1339160120-000		
BULK-HEAD MOUNTED			PG16	H10A-AGS	T1509101000-000	BULK-HEAD MOUNTED				PG16	H16A-TG-PG16	T1329160116-000
					H10A-ADMS						T1519101000-000	M20
		M20	PG21	H10A-SGRS-PG21	T1619101121-000				PG21	H16A-TG-PG21	T1329160121-000	
				H10A-SGRS-M20	T1619101120-000			M25	H16A-TG-M25	T1329160125-000		
Surface Mounted-Side Entry		M25	PG16	H10A-SGRS-PG16	T1619101116-000		Surface Mounted-Side Entry			PG16	H16A-TGH-PG16	T1349160116-000
				H10A-SGRS-M25	T1619101125-000						M20	H16A-TGH-M20
		M20	PG21	H10A-SDRMS-PG21	T1629101121-000				PG21	H16A-TGH-PG21	T1349160121-000	
				H10A-SDRMS-M20	T1629101120-000			M25	H16A-TGH-M25	T1349160125-000		
Cable-to-Cable Hoods		M20	PG16	H10A-TBFS-PG16	T1739101116-000	Cable-to-Cable Hoods				PG16	H16A-AGS	T1509161000-000
				H10A-TBFS-M20	T1739101120-000							H16A-ADMS
		M25	PG21	H10A-TBFS-PG21	T1739101121-000				H16A-ADS	T1519162000-000		
				H10A-TBFS-M25	T1739101125-000				PG16	H16A-SGRS-PG16	T1619161116-000	
H8A Thermo-plastic Hoods & Housings		M25	PG16	H8A-TG-M25	T1329081125-000		Surface Mounted-Side Entry			PG16	H16A-SGRS-M20	T1619161120-000
					H8A-TS-PG16						T1359090116-000	PG21
		Bulkhead Mounted			H8A-AG			T1509081100-000		M25	H16A-SGRS-M25	T1619161125-000
H8A Thermo-plastic Hoods & Housings		M25	PG16	H8A-TG-M25	T1329081125-000	Surface Mounted-Side Entry				PG16	H16A-SDRMS-M20	T1629161120-000
												H8A-TS-PG16
		Bulkhead Mounted			H8A-AG			T1509081100-000		M25	H16A-SDRMS-M25	T1629161125-000
H8A Thermo-plastic Hoods & Housings		M20	PG21	H8A-TG-M20	T1329081120-000		Surface Mounted-Side Entry			PG21	H16A-SDRS-M20	T1629163120-000
												H8A-TS-PG21
		Bulkhead Mounted			H8A-AG			T1509081100-000		M25	H16A-SDRS-M25	T1629163125-000
H8A Thermo-plastic Hoods & Housings		M20	PG21	H8A-TG-M20	T1329081120-000	Cable-to-Cable Hoods				PG21	H16A-TBFS-PG21	T1739161121-000
												H8A-TS-PG21
		Bulkhead Mounted			H8A-AG			T1509081100-000		M25	H16A-TBFS-M25	T1739161125-000
H8A Thermo-plastic Hoods & Housings		M20	PG21	H8A-TG-M20	T1329081120-000		Cable-to-Cable Hoods			PG21	H16A-TBFHS-PG21	T1779161121-000
												H8A-TS-PG21
		Bulkhead Mounted			H8A-AG			T1509081100-000		M25	H16A-TBFHS-M25	T1779161125-000

Hoods & Housings

TE Connectivity's Heavy Duty Connectors

Hoods and Housings IP65











H32A Metal Hoods and Housings

H32A metal Hoods & Housings	Product Image	Metr.	PG	Type	PN
Hoods: Side Entry			PG16	H32A-TS-PG16	T1319320116-000
		M20		H32A-TS-M20	T1319320120-000
			PG21	H32A-TS-PG21	T1319320121-000
		M25		H32A-TS-M25	T1319320125-000
			PG29	H32A-TS-PG29	T1319320129-000
		M32		H32A-TS-M32	T1319320132-000
Hoods: Top Entry			PG21	H32A-TG-PG21	T1329320121-000
		M25		H32A-TG-M25	T1329320125-000
			PG29	H32A-TG-PG29	T1329320129-000
		M32		H32A-TG-M32	T1329320132-000
		M40		H32A-TG-M40	T1329320140-000
		M50		H32A-TG-M50	T1329320150-000
BULKHEAD MOUNTED		-		H32A-AG	T1419320000-000
Surface Mounted-Side Entry			PG21	H32A-SGR-PG21	T1449320121-000
		M25		H32A-SGR-M25	T1449320125-000
			PG29	H32A-SGR-PG29	T1449320129-000
		M32		H32A-SGR-M32	T1449320132-000
			PG21	H32A-SGR-2PG21	T1449320221-000
		M25		H32A-SGR-2M25	T1449320225-000
	PG29	H32A-SGR-2PG29	T1449320229-000		
M32		H32A-SGR-2M32	T1449320232-000		

TE Connectivity's Heavy Duty Connectors

Hoods and Housings IP65

H6B Metal Hoods and Housings

H6B metal Hoods	Product Image	Metr.	PG	Type	PN	H6B metal Housings	Product Image	Metr.	PG	Type	PN
Hoods: Side Entry			PG11	H6B-TS-PG11	T1310060111-000	Bulkhead Mounted				H6B-AG	T1500063000-000
			PG13.5	H6B-TS-PG13.5	T1310060113-000					H6B-AD	T1510063000-000
			PG16	H6B-TS-PG16	T1310060116-000	Surface Mounted-Side Entry			PG13.5	H6B-SGR-PG13.5	T1610063113-000
			PG21	H6B-TS-PG21	T1310060121-000				PG16	H6B-SGR-PG16	T1610063116-000
		M16		H6B-TS-M16	T1311061116-000			M20		H6B-SGR-M20	T1610063120-000
		M20		H6B-TS-M20	T1310060120-000				PG21	H6B-SGR-PG21	T1610063121-000
	M25		H6B-TS-M25	T1310060125-000	M25				H6B-SGR-M25	T1610063125-000	
								PG13.5	H6B-SGRS-PG13.5	T1610062113-000	
			PG13.5	H6B-TSH-PG13.5	T1330060113-000	Surface Mounted-Side Entry			PG16	H6B-SGRS-PG16	T1610062116-000
			PG21	H6B-TSH-PG21	T1330060121-000			M20		H6B-SGRS-M20	T1610062120-000
			PG29	H6B-TSH-PG29	T1330060129-000			M25		H6B-SGRS-M25	T1610062125-000
		M20		H6B-TSH-M20	T1330060120-000				PG13.5	H6B-SDR-PG13.5	T1620063113-000
M25			H6B-TSH-M25	T1330060125-000				PG16	H6B-SDR-PG16	T1620063116-000	
M32			H6B-TSH-M32	T1330060132-000	M20				H6B-SDR-M20	T1620063120-000	
Hoods: Top Entry			PG13.5	H6B-TG-PG13.5	T1320060113-000	Surface Mounted-Side Entry			PG21	H6B-SDR-PG21	T1620063121-000
			PG16	H6B-TG-PG16	T1320060116-000			M25		H6B-SDR-M25	T1620063125-000
			PG21	H6B-TG-PG21	T1320060121-000				PG15	H6B-SDRM-PG16	T1620064116-000
		M12		H6B-TG-M12	T1321060112-000			M20		H6B-SDRM-M20	T1620064120-000
		M16		H6B-TG-M16	T1321061116-000			M25		H6B-SDRM-M25	T1620064125-000
		M20		H6B-TG-M20	T1320060120-000				PG13.5	H6B-SDRS-PG13.5	T1620062113-000
			PG21	H6B-TGH-PG21	T1340060121-000	Surface Mounted-Side Entry		M20		H6B-SDRS-M20	T1620062120-000
			PG29	H6B-TGH-PG29	T1340060129-000				PG16	H6B-SDRMS-PG16	T1620064316-000
		M20		H6B-TGH-M20	T1340060120-000			M20		H6B-SDRMS-M20	T1620064320-000
		M25		H6B-TGH-M25	T1340060125-000			M25		H6B-SDRMS-M25	T1620064325-000
		M30		H6B-TGH-M30	T1340060130-000				PG21	H6B-SGRHS-PG21	T1650062121-000
		M32		H6B-TGH-M32	T1340060132-000			M32		H6B-SGRHS-M32	T1650062132-000
Cable-to-Cable Hood			PG16	H6B-TBFS-PG16	T1730062116-000	Surface Mounted-Side Entry			PG29	H6B-SDRHMS-PG29	T1660062329-000
		M20		H6B-TBFS-M20	T1730062120-000			M32		H6B-SDRHMS-M32	T1660062332-000
		M25		H6B-TBFS-M25	T1730062125-000				PG21	H6B-SGRH-PG21	T1650063121-000
		M25		H6B-TBFS-M25	T1730062132-000				PG29	H6B-SGRH-PG29	T1650063129-000
			PG16	H6B-TBF-PG16	T1730063116-000			M32		H6B-SGRH-M32	T1650063132-000
		M20		H6B-TBF-M20	T1730063120-000				PG21	H6B-SDRHM-PG21	T1660063321-000
		M25		H6B-TBF-M25	T1730063125-000		PG29	H6B-SDRHM-PG29	T1660063329-000		
			PG16	H6B-TBF-PG16	T1730063116-000	M32		H6B-SDRHM-M32	T1660063332-000		
		M20		H6B-TBF-M20	T1730063120-000		PG21	H6B-SDRH-PG21	T1660063121-000		
		M25		H6B-TBF-M25	T1730063125-000		PG29	H6B-SDRH-PG29	T1660063129-000		
		M32		H6B-TBF-M32	T1730063132-000	M32		H6B-SDRH-M32	T1660063132-000		
		M20		H6B-TBFH-M20	T1770062120-000		PG21	H6B-SDRH-PG21	T1660063121-000		
			PG21	H6B-TBFH-PG21	T1770063121-000	M25		H6B-SDRH-M25	T1660063125-000		
		M25		H6B-TBFH-M25	T1770063125-000		PG29	H6B-SDRH-PG29	T1660063129-000		
			PG29	H6B-TBFH-PG29	T1770063129-000	M32		H6B-SDRH-M32	T1660063132-000		
		M32		H6B-TBFH-M32	T1770063132-000						

Hoods & Housings







TE Connectivity's Heavy Duty Connectors

Hoods and Housings IP65

H10B Metal Hoods and Housings

H10B metal Hoods	Product Image	Metr.	PG	Type	PN	H10B metal Housings	Product Image	Metr.	PG	Type	PN		
Hoods: Side Entry			PG13.5	H10B-TS-PG13.5	T1210100113-000	Bulkhead Mounted				H10B-AGS	T1410101000-000		
			PG16	H10B-TS-PG16	T1210100116-000					H10B-AG	T1410102000-000		
		M20		H10B-TS-M20	T1210100120-000	Bulkhead Mounting with 4 Bolts				H10B-AD-BO	T1430100000-000		
			PG21	H10B-TS-PG21	T1210100121-000					H10B-ADM-BO	T1430101000-000		
		M25		H10B-TS-M25	T1210100125-000								
		M32		H10B-TS-M32	T1210100132-000	Surface Mounted-Side Entry		M20	PG16	H10B-SGRS-PG16	T1440101116-000		
		PG16	H10B-TSH-PG16	T1230100116-000					H10B-SGRS-M20	T1440101120-000			
	M20		H10B-TSH-M20	T1230100120-000					PG21	H10B-SGRS-PG21	T1440101121-000		
		PG21	H10B-TSH-PG21	T1230100121-000					M25		H10B-SGRS-M25	T1440101125-000	
	M25		H10B-TSH-M25	T1230100125-000					M20	PG16	H10B-SGR-PG16	T1440102116-000	
	PG29	H10B-TSH-PG29	T1230100129-000			M25		H10B-SGR-M20	T1440102120-000				
	M32		H10B-TSH-M32	T1230100132-000			M25	PG21	H10B-SGR-PG21	T1440102121-000			
	M40		H10B-TSH-M40	T1230100140-000			M25		H10B-SGR-M25	T1440102125-000			
Hoods: Top Entry			PG13.5	H10B-TG-PG13.5	T1220100113-000	Bulkhead Mounting with 4 Bolts							
			PG16	H10B-TG-PG16	T1220100116-000					PG16	H10B-SDR-BO-PG16	T1460100116-000	
		M20		H10B-TG-M20	T1220100120-000					M20		H10B-SDR-BO-M20	T1460100120-000
			PG21	H10B-TG-PG21	T1220100121-000						PG21	H10B-SDR-BO-PG21	T1460100121-000
		M25		H10B-TG-M25	T1220100125-000					M25		H10B-SDRM-BO-PG16	T1460101116-000
			M32		H10B-TG-M32			T1220100132-000			M20		H10B-SDRM-BO-M20
		M36		H10B-TG-M36	T1220100136-000			M25		H10B-SDRM-BO-PG21	T1460101121-000		
								M25		H10B-SDRM-BO-M25	T1460101125-000		
				PG16	H10B-TGH-PG16	T1240100116-000	Surface Mounted-Side Entry						
	M20		H10B-TGH-M20	T1240100120-000						PG21	H10B-SGRHS-PG21	T1470101121-000	
	PG21	H10B-TGH-PG21	T1240100121-000						PG29	H10B-SGRHS-PG29	T1470101129-000		
M25		H10B-TGH-M25	T1240100125-000			M32				H10B-SGRHS-M32	T1470101132-000		
	PG29	H10B-TGH-PG29	T1240100129-000						PG16	H10B-SGRH-PG16	T1470102116-000		
M30		H10B-TGH-M30	T1240100130-000						PG21	H10B-SGRH-PG21	T1470102121-000		
	M32		H10B-TGH-M32	T1240100132-000			M25		H10B-SGRH-M25	T1470102125-000			
	M40		H10B-TGH-M40	T1240100140-000				PG29	H10B-SGRH-PG29	T1470102129-000			
Side Entry Housings with Levers			PG16	H10B-TSB-PG16	T1250102116-000	Bulkhead Mounting with 4 Bolts							
		M20		H10B-TSB-M20	T1250102120-000					PG21	H10B-SDRH-BO-PG21	T1490100121-000	
		M25		H10B-TSB-M25	T1250102125-000					M25		H10B-SDRH-BO-M25	T1490100125-000
			PG16	H10B-TGB-PG16	T1260102116-000								
		M20		H10B-TGB-M20	T1260102120-000					PG29	H10B-SDRH-BO-PG29	T1490100129-000	
		M25		H10B-TGB-M25	T1260102125-000					M32		H10B-SDRH-BO-M32	T1490100132-000
			PG21	H10B-TGB-PG21	T1260102121-000								
		M25		H10B-TGB-M25	T1260102125-000					PG21	H10B-SDRH-BO-PG21	T1490101121-000	
			PG29	H10B-TGB-PG29	T1260102129-000					PG29	H10B-SDRH-BO-PG29	T1490101129-000	
		M32		H10B-TGB-M32	T1260102132-000					M32		H10B-SDRH-BO-M32	T1490101132-000
			PG21	H10B-TSBH-PG21	T1270102121-000								
		M25		H10B-TSBH-M25	T1270102125-000					PG16	H10B-TBFS-PG16	T1710101116-000	
			PG29	H10B-TSBH-PG29	T1270102129-000					M20		H10B-TBFS-M20	T1710101120-000
		M32		H10B-TSBH-M32	T1270102132-000					M25		H10B-TBFS-M25	T1710101125-000
			PG21	H10B-TGBH-PG21	T1280102121-000								
		M25		H10B-TGBH-M25	T1280102125-000					PG16	H10B-TBF-PG16	T1710102116-000	
			PG29	H10B-TGBH-PG29	T1280102129-000					M20		H10B-TBF-M20	T1710102120-000
			PG16	H10B-TSBS-PG16	T1250103116-000	Cable-to-Cable Hood							
			PG21	H10B-TSBS-PG21	T1250103121-000					M25		H10B-TBF-M25	T1710102125-000
		M20		H10B-TSBS-M20	T1250103120-000						PG16	H10B-TBF-LB-PG16	T1730103116-000
M25			H10B-TSBS-M25	T1250103125-000					M20		H10B-TBF-LB-M20	T1730103120-000	
		PG16	H10B-TGBS-PG16	T1260103116-000					M25		H10B-TBF-LB-M25	T1730103125-000	
M20			H10B-TGBS-M20	T1260103120-000						PG21	H10B-TBFHS-PG21	T1750101121-000	
M25			H10B-TGBS-M25	T1260103125-000					M25		H10B-TBFHS-M25	T1750101125-000	
		PG21	H10B-TGBHS-PG21	T1270103121-000						PG29	H10B-TBFHS-PG29	T1750101129-000	
M25			H10B-TGBHS-M25	T1270103125-000					M32		H10B-TBFHS-M32	T1750101132-000	
		PG29	H10B-TGBHS-PG29	T1270103129-000						PG16	H10B-TBFH-PG16	T1750102116-000	
M32			H10B-TGBHS-M32	T1270103132-000						PG21	H10B-TBFH-PG21	T1750102121-000	
		PG21	H10B-TGBHS-PG21	T1280103121-000						PG29	H10B-TBFH-PG29	T1750102129-000	
	M25		H10B-TGBHS-M25	T1280103125-000			M32		H10B-TBFH-M32	T1750102132-000			
	PG29	H10B-TGBHS-PG29	T1280103129-000										

H10B Metal Hoods and Housings

H10B metal Hoods	Product Image	Metr.	PG	Type	PN	H10B metal Housings	Product Image	Metr.	PG	Type	PN	
Hoods: Side Entry			PG13.5	H10B-TS-RO-PG13.5	T1310100113-000	Bulkhead Mounted				H10B-AG-LB	T1500103000-000	
			PG16	H10B-TS-RO-PG16	T1310100116-000					H10B-AD-LB	T1510103000-000	
			PG21	H10B-TS-RO-PG21	T1310100121-000					H10B-ADM-LB	T1510103001-000	
		M16		H10B-TS-RO-M16	T1310100016-000				PG16	H10B-SGR-LB-PG16	T1610103116-000	
		M20		H10B-TS-RO-M20	T1310100120-000				M20	H10B-SGR-LB-M20	T1610103120-000	
		M25		H10B-TS-RO-M25	T1310100125-000				PG21	H10B-SGR-LB-PG21	T1610103121-000	
		M20		H10B-TSH-RO-M20	T1330100120-000		M25		H10B-SGR-LB-M25	T1610103125-000		
		M25		H10B-TSH-RO-M25	T1330100125-000		PG21	H10B-SGRH-LB-PG21	T1650103121-000			
		M32		H10B-TSH-RO-M32	T1330100132-000		PG29	H10B-SGRH-LB-PG29	T1650103129-000			
			PG21	H10B-TSH-RO-PG21	T1330100121-000		M32		H10B-SGRH-LB-M32	T1650103132-000		
			PG29	H10B-TSH-RO-PG29	T1330100129-000		PG16	H10B-SGRS-LB-PG16	T1610102116-000			
			PG21	H10B-TG-RO-PG21	T1320100121-000		M20		H10B-SGRS-LB-M20	T1610102120-000		
Hoods: Top Entry			PG16	H10B-TG-RO-PG16	T1320100116-000	Surface Mounted-Side Entry			PG21	H10B-SGRS-LB-PG21	T1610102121-000	
		M20		H10B-TG-RO-M20	T1320100120-000				M25		H10B-SGRS-LB-M25	T1610102125-000
		M25		H10B-TG-RO-M25	T1320100125-000				PG16	H10B-SDR-LB-PG16	T1620103116-000	
			PG21	H10B-TGH-RO-PG21	T1340100121-000				M20		H10B-SDR-LB-M20	T1620103120-000
			PG29	H10B-TGH-RO-PG29	T1340100129-000				PG21	H10B-SDR-LB-PG21	T1620103121-000	
		M25		H10B-TGH-RO-M25	T1340100125-000				M25		H10B-SDR-LB-M25	T1620103125-000
Housings: Top Entry			PG21	H10B-TSBH-LB-PG21	T1370102121-000				PG16	H10B-SDRM-LB-1PG16	T1620103416-000	
			PG29	H10B-TSBH-LB-PG29	T1370102129-000				M20		H10B-SDRM-LB-M20	T1620103420-000
			PG21	H10B-TBFH-LB-PG21	T1770103121-000				M25		H10B-SDRM-LB-1M25	T1620103425-000
		M25		H10B-TBFH-LB-M25	T1770103125-000				PG21	H10B-SDRH-LB-PG21	T1660103121-000	
			PG29	H10B-TBFH-LB-PG29	T1770103129-000				M25		H10B-SDRH-LB-M25	T1660103125-000
		M32		H10B-TBFH-LB-M32	T1770103132-000				PG29	H10B-SDRH-LB-PG29	T1660103129-000	
						M32		H10B-SDRH-LB-M32	T1660103132-000			
						PG21	H10B-SDRHM-LB-PG21	T1660103321-000				
						PG29	H10B-SDRHM-LB-PG29	T1660103329-000				
						M32		H10B-SDRHM-LB-M32	T1660103332-000			
						M25		H10B-SDRHS-LB-M25	T1660102125-000			
						M25		H10B-SDRS-LB-M25	T1620102125-000			

TE Connectivity's Heavy Duty Connectors

Hoods and Housings IP65

H16B Metal Hoods and Housings

















H16B metal Hoods	Product Image	Metr.	PG	Type	PN	H16B metal Housings	Product Image	Metr.	PG	Type	PN			
Hoods: Side Entry			PG16	H16B-TS-PG16	T1210160116-000	Bulkhead Mounted				H16B-AGS	T1410161000-000			
		M20		H16B-TS-M20	T1210160120-000					H16B-AG	T1410162000-000			
			PG21	H16B-TS-PG21	T1210160121-000	Bulkhead Mounting with 4 Bolts				H16B-AD-BO	T1430160000-000			
		M25		H16B-TS-M25	T1210160125-000					H16B-ADM-BO	T1430161000-000			
		M32		H16B-TS-M32	T1210160132-000									
		M25		H16B-TSH-M25	T1230160125-000	Surface Mounted-Side Entry			PG21	H16B-SGRS-PG21	T1440161121-000			
		M32		H16B-TSH-M32	T1230160132-000				M25		H16B-SGRS-M25	T1440161125-000		
		M40		H16B-TSH-M40	T1230160140-000					PG21	H16B-SGR-PG21	T1440162121-000		
			PG21	H16B-TSH-PG21	T1230160121-000				M25		H16B-SGR-M25	T1440162125-000		
			PG29	H16B-TSH-PG29	T1230160129-000					PG21	H16B-SGR-BO-PG21	T1450160121-000		
Hoods: Top Entry			PG16	H16B-TG-PG16	T1220160116-000	Bulkhead Mounting with 4 Bolts								
		M20		H16B-TG-M20	T1220160120-000									
			PG21	H16B-TG-PG21	T1220160121-000					PG21	H16B-SDR-BO-PG21	T1460160121-000		
		M25		H16B-TG-M25	T1220160125-000				M25		H16B-SDR-BO-M25	T1460160125-000		
			PG29	H16B-TG-PG29	T1220160129-000					PG21	H16B-SDRM-BO-PG21	T1460161121-000		
		M32		H16B-TG-M32	T1220160132-000				M25		H16B-SDRM-BO-M25	T1460161125-000		
		M36		H16B-TG-M36	T1220160136-000			PG21	H16B-SDR-RO-PG21	T1460160121-100				
			PG21	H16B-TGH-PG21	T1240160121-000	Surface Mounted-Side Entry								
		M25		H16B-TGH-M25	T1240160125-000				M25		H16B-SGRH-M25	T1470162125-000		
			PG29	H16B-TGH-PG29	T1240160129-000					PG29	H16B-SGRH-PG29	T1470162129-000		
M32		H16B-TGH-M32	T1240160132-000		M32				H16B-SGRH-M32	T1470162132-000				
Cable-to-Cable Hoods			PG16	H16B-TBFH-PG16	T1710161116-000	Side Entry Housings with Two Levers								
		M20		H16B-TBFH-M20	T1710161120-000									
			PG21	H16B-TBFH-PG21	T1710161121-000					M20		H16B-TSB-M20	T1250162120-000	
		M25		H16B-TBFH-M25	T1710161125-000						PG21	H16B-TSB-PG21	T1250162121-000	
			PG21	H16B-TBF-PG21	T1710162121-000					M25		H16B-TSB-M25	T1250162125-000	
		M25		H16B-TBF-M25	T1710162125-000					M32		H16B-TSB-M32	T1250162132-000	
			PG29	H16B-TBF-PG29	T1710162129-000						PG21	H16B-TSBS-PG21	T1250163121-000	
		M32		H16B-TBF-M32	T1710162132-000					M25		H16B-TSBS-M25	T1250163125-000	
										M32		H16B-TSBS-M32	T1250163132-000	
											PG21	H16B-TSBH-PG21	T1270162121-000	
										M25		H16B-TSBH-M25	T1270162125-000	
			PG21	H16B-TBFHS-PG21	T1750161121-000						PG29	H16B-TSBH-PG29	T1270162129-000	
			PG29	H16B-TBFHS-PG29	T1750161129-000									
			M32		H16B-TBFHS-M32			T1750161132-000			M32		H16B-TSBH-M32	T1270162132-000
				PG21	H16B-TBFH-PG21			T1750162121-000				PG21	H16B-TSBHS-PG21	T1270163121-000
			M25		H16B-TBFH-M25			T1750162125-000			M25		H16B-TSBHS-M25	T1270163125-000
				PG29	H16B-TBFH-PG29			T1750162129-000				PG29	H16B-TSBHS-PG29	T1270163129-000
			M32		H16B-TBFH-M32			T1750162132-000			M32		H16B-TSBHS-M32	T1270163132-000
	M40		H16B-TBFH-M40	T1750162140-000			M40		H16B-TSBHS-M40	T1270163140-000				

Hoods & Housings

TE Connectivity's Heavy Duty Connectors

Hoods and Housings IP65

H16B Metal Hoods and Housings

H16B metal Hoods	Product Image	Metr.	PG	Type	PN	H16B metal Housings	Product Image	Metr.	PG	Type	PN				
Hoods: Side Entry		M20		H16B-TS-RO-M20	T1310160120-000	Bulkhead Mounted				H16B-AGS-LB	T1500162000-000				
			PG21	H16B-TS-RO-PG21	T1310160121-000					H16B-AG-LB	T1500163000-000				
		M25		H16B-TS-RO-M25	T1310160125-000					H16B-ADS-LB	T1510162000-000				
		M32		H16B-TS-RO-M32	T1310160132-000					H16B-ADMS-LB	T1510162001-000				
			PG21	H16B-TSH-RO-PG21	T1330160121-000						H16B-AD-LB	T1510163000-000			
		M25		H16B-TSH-RO-M25	T1330160125-000					H16B-ADM-LB	T1510163001-000				
			PG29	H16B-TSH-RO-PG29	T1330160129-000					H16B-ADM-LB	T1510163002-000				
		M32		H16B-TSH-RO-M32	T1330160132-000										
		M40		H16B-TSH-RO-M40	T1330160140-000										
Hoods: Top Entry			PG21	H16B-TG-RO-PG21	T1320160121-000	Surface Mounted-Side Entry			PG21	H16B-SGR-LB-PG21	T1610163121-000				
		M25		H16B-TG-RO-M25	T1320160125-000			M25		H16B-SGR-LB-M25	T1610163125-000				
		M32		H16B-TG-RO-M32	T1320160132-000				PG21	H16B-SGRH-LB-PG21	T1650163121-000				
			PG21	H16B-TGH-RO-PG21	T1340160121-000					PG29	H16B-SGRH-LB-PG29	T1650163129-000			
		M25		H16B-TGH-RO-M25	T1340160125-000		M32			H16B-SGRH-LB-M32	T1650163132-000				
		M32		H16B-TGH-RO-M32	T1340160132-000				PG21	H16B-SDR-LB-PG21	T1620163121-000				
Cable-to-Cable Hood			PG21	H16B-TBFH-LB-PG21	T1730163121-000	Surface Mounted-Side Entry			PG21	H16B-SDR-LB-PG21	T1620163120-000				
		M25		H16B-TBF-LB-M25	T1730163125-000			M25		H16B-SDR-LB-M25	T1620163125-000				
		M32		H16B-TBF-LB-M32	T1730163132-000			M32		H16B-SDR-LB-M32	T1660163132-000				
			PG21	H16B-TBFH-LB-PG21	T1770162121-000				PG21	H16B-SDRM-LB-PG21	T1620163421-000				
			PG29	H16B-TBFH-LB-PG29	T1770162129-000			M25		H16B-SDRM-LB-M25	T1620163425-000				
		M32		H16B-TBFH-LB-M32	T1770162132-000				PG21	H16B-SDRHM-LB-PG21	T1660163121-100				
Protection covers for Hoods		-		H16B-KDTP-LB	T1010161500-000	Surface Mounted-Side Entry			PG29	H16B-SDRHM-LB-PG29	T1660163129-100				
		-		H16B-KDBP	T1010162100-000				PG21	H16B-TGB-PG21	T1260162121-000				
Top Entry Housings with Two Levers		M25		H16B-TGB-M25	T1260162125-000	Top Entry Housings with Two Levers			PG21	H16B-TGB-PG21	T1260162121-000				
		M32		H16B-TGB-M32	T1260162132-000				PG21	H16B-TGB-PG21	T1260163121-000				
			PG16	H16B-TGBS-PG16	T1260163116-000				PG21	H16B-TGBS-PG21	T1260163121-000				
			PG21	H16B-TGBS-PG21	T1260163121-000				PG21	H16B-TGBS-PG21	T1260163121-000				
		M25		H16B-TGBS-M25	T1260163125-000				PG21	H16B-TGBS-M25	T1260163125-000				
			PG21	H16B-TGBH-PG21	T1280162121-000				PG21	H16B-TGBH-PG21	T1280162121-000				
		M25		H16B-TGBH-M25	T1280162125-000				PG21	H16B-TGBH-PG21	T1280162121-000				
			PG29	H16B-TGBH-PG29	T1280162129-000				PG29	H16B-TGBH-PG29	T1280162129-000				
		M32		H16B-TGBH-M32	T1280162132-000				PG21	H16B-TGBH-M32	T1280162132-000				
		M40		H16B-TGBH-M40	T1280162140-000				PG21	H16B-TGBH-M40	T1280162140-000				
			PG21	H16B-TGBHS-PG21	T1280163121-000				PG21	H16B-TGBHS-PG21	T1280163121-000				
			PG29	H16B-TGBHS-PG29	T1280163129-000				PG29	H16B-TGBHS-PG29	T1280163129-000				
		M25		H16B-TGBHS-M25	T1280163125-000				PG21	H16B-TGBHS-M25	T1280163125-000				
		M32		H16B-TGBHS-M32	T1280163132-000				PG21	H16B-TGBHS-M32	T1280163132-000				
		M40		H16B-TGBHS-M40	T1280163140-000				PG21	H16B-TGBHS-M40	T1280163140-000				
		Bulkhead Mounting with 4 Bolts			PG21			H16B-SDRH-BO-PG21	T1490160121-000	Bulkhead Mounting with 4 Bolts			PG21	H16B-SDRH-BO-PG21	T1490160121-000
					PG29			H16B-SDRH-BO-PG29	T1490160129-000				PG29	H16B-SDRH-BO-PG29	T1490160129-000
				M32				H16B-SDRH-BO-M32	T1490160132-000				PG21	H16B-SDRH-BO-PG21	T1490161121-000
					PG21			H16B-SDRH-BO-PG21	T1490161121-000				PG29	H16B-SDRH-BO-PG29	T1490161129-000
					PG29			H16B-SDRH-BO-PG29	T1490161129-000				M32	H16B-SDRH-BO-M32	T1490161132-000
M32				H16B-SDRH-BO-M32	T1490161132-000		PG21	H16B-SDRH-BO-PG21	T1490161221-000						
	PG21			H16B-SDRH-BO-PG21	T1490161221-000		PG29	H16B-SDRH-BO-PG29	T1490161229-000						
	PG29			H16B-SDRH-BO-PG29	T1490161229-000		M32	H16B-SDRH-BO-M32	T1490161232-000						
	M32				H16B-SDRH-BO-M32	T1490161232-000									

TE Connectivity's Heavy Duty Connectors

Hoods and Housings IP65

H24B Metal Hoods and Housings

H24B metal Hoods	Product Image	Metr.	PG	Type	PN	H24B metal Housings	Product Image	Metr.	PG	Type	PN
Hoods: Side Entry			PG16	H24B-TS-PG16	T1210240116-000	Bulkhead Mounted		-	-	H24B-AG	T1410242000-000
		M20		H24B-TS-M20	T1210240120-000			-	-	H24B-AGS	T1410241000-000
			PG21	H24B-TS-PG21	T1210240121-000				PG21	H24B-SGRS-PG21	T1440241121-000
		M25		H24B-TS-M25	T1210240125-000			M25		H24B-SGRS-M25	T1440241125-000
		M32		H24B-TS-M32	T1210240132-000				PG21	H24B-SGR-PG21	T1440242121-000
			PG21	H24B-TSH-PG21	T1230240121-000	Surface Mounted-Side Entry		M25		H24B-SGR-M25	T1440242125-000
		M25		H24B-TSH-M25	T1230240125-000				PG21	H24B-SGRHS-PG21	T1470241121-000
			PG29	H24B-TSH-PG29	T1230240129-000				PG29	H24B-SGRHS-PG29	T1470241129-000
		M32		H24B-TSH-M32	T1230240132-000			M32		H24B-SGRHS-M32	T1470241132-000
		M40		H24B-TSH-M40	T1230240140-000				PG21	H24B-SGRH-PG21	T1470242121-000
Hoods: Top Entry			PG16	H24B-TG-PG16	T1220240116-000	Side Entry Housings with Two Levers			PG21	H24B-TSB-PG21	T1250242121-000
			PG21	H24B-TG-PG21	T1220240121-000			M25		H24B-TSB-M25	T1250242125-000
		M25		H24B-TG-M25	T1220240125-000			M32		H24B-TSB-M32	T1250242132-000
			PG29	H24B-TG-PG29	T1220240129-000				PG16	H24B-TSBH-PG16	T12X0240116-000
		M32		H24B-TG-M32	T1220240132-000				PG21	H24B-TSBH-PG21	T1270242121-000
			PG21	H24B-TGH-PG21	T1240240121-000				PG29	H24B-TSBH-PG29	T1270242129-000
		M25		H24B-TGH-M25	T1240240125-000			M32		H24B-TSBH-M32	T1270242132-000
			PG29	H24B-TGH-PG29	T1240240129-000			M40		H24B-TSBH-M40	T1270242140-000
		M32		H24B-TGH-M32	T1240240132-000				PG21	H24B-TSBS-PG21	T1250243121-000
		M36		H24B-TGH-M36	T1240240136-000			M25		H24B-TSBS-M25	T1250243125-000
Cable-to-Cable Hoods		M40		H24B-TGH-M40	T1240240140-000	M32		H24B-TSBS-M32	T1250243132-000		
			PG21	H24B-TBFS-PG21	T1710241121-000	M25		H24B-TSBHS-M25	T1270243125-000		
		M25		H24B-TBFS-M25	T1710241125-000		PG21	H24B-TSBHS-PG21	T1270243121-000		
		M32		H24B-TBFS-M32	T1710241132-000		PG29	H24B-TSBHS-PG29	T1270243129-000		
			PG21	H24B-TBF-PG21	T1710242121-000	M32		H24B-TSBHS-M32	T1270243132-000		
		M25		H24B-TBF-M25	T1710242125-000	M40		H24B-TSBHS-M40	T1270243140-000		
			PG29	H24B-TBF-PG29	T1710242129-000		PG21	H24B-TGB-PG21	T1260242121-000		
		M32		H24B-TBF-M32	T1710242132-000	M25		H24B-TGB-M25	T1260242125-000		
			PG21	H24B-TBFHS-PG21	T1750241121-000		PG29	H24B-TGB-PG29	T1260242129-000		
		M25		H24B-TBFHS-M25	T1750241125-000	M32		H24B-TGB-M32	T1260242132-000		
			PG29	H24B-TBFHS-PG29	T1750241129-000		PG21	H24B-TGBH-PG21	T1280242121-000		
		M32		H24B-TBFHS-M32	T1750241132-000	M25		H24B-TGBH-M25	T1280242125-000		
			PG21	H24B-TBFH-PG21	T1750242121-000		PG29	H24B-TGBH-PG29	T1280242129-000		
		M25		H24B-TBFH-M25	T1750242125-000	M32		H24B-TGBH-M32	T1280242132-000		
			PG29	H24B-TBFH-PG29	T1750242129-000	M40		H24B-TGBH-M40	T1280242140-000		
		M32		H24B-TBFH-M32	T1750242132-000		PG21	H24B-TGBS-PG21	T1260243121-000		
Hoods: Side Entry			PG21	H24B-TS-RO-PG21	T1310240121-000	Bulkhead Mounted				H24B-AG-LB	T1500243000-000
		M25		H24B-TS-RO-M25	T1310240125-000					H24B-AD-LB	T1510243000-000
		M32		H24B-TS-RO-M32	T1310240132-000					H24B-ADM-LB	T1510243100-000
			PG21	H24B-TSH-RO-PG21	T1330240121-000	Surface Mounted-Side Entry			PG21	H24B-SGR-LB-PG21	T1610243121-000
		M25		H24B-TSH-RO-M25	T1330240125-000			M25		H24B-SGR-LB-M25	T1610243125-000
			PG29	H24B-TSH-RO-PG29	T1330240129-000				PG21	H24B-SGRH-LB-PG21	T1650243121-000
		M32		H24B-TSH-RO-M32	T1330240132-000				PG29	H24B-SGRH-LB-PG29	T1650243129-000
								M32		H24B-SGRH-LB-M32	T1650243132-000
		M40		H24B-TSH-RO-M40	T1330240140-000						

Hoods & Housings

TE Connectivity's Heavy Duty Connectors

Hoods and Housings IP65

H24B Metal Hoods and Housings













H24B metal Hoods	Product Image	Metr.	PG	Type	PN	H24B metal Housings	Product Image	Metr.	PG	Type	PN
Hoods: Top Entry			PG21	H24B-TG-RO-PG21	T1320240121-000	Surface Mounting with protection cover			PG21	H24B-SDR-LB-PG21	T1620243121-000
		M25		H24B-TG-RO-M25	T1320240125-000			M25		H24B-SDR-LB-M25	T1620243125-000
			PG29	H24B-TG-RO-PG29	T1320240129-000				PG21	H24B-SDRM-LB-PG21	T1620243421-000
		M32		H24B-TG-RO-M32	T1320240132-000			M25		H24B-SDRM-LB-M25	T1620243425-000
			PG21	H24B-TGH-RO-PG21	T1340240121-000				PG21	H24B-SDRH-LB-PG21	T1660243121-000
		M25		H24B-TGH-RO-M25	T1340240125-000				PG29	H24B-SDRH-LB-PG29	T1660243129-000
			PG29	H24B-TGH-RO-PG29	T1340240129-000				M32	H24B-SDRH-LB-M32	T1660243132-000
		M32		H24B-TGH-RO-M32	T1340240132-000				PG21	H24B-SDRHM-LB-PG21	T1660243121-100
			PG21	H24B-TGH-RO-M40	T1340240140-000				PG29	H24B-SDRHM-LB-PG29	T1660243129-100
		M40		H24B-TGH-RO-M40	T1340240140-000				M32	H24B-SDRHM-LB-M32	T1660243132-100
Cable-to-Cable Hoods			PG21	H24B-TBF-LB-PG21	T1730242121-000	-	-	-	-	-	-
		M25		H24B-TBF-LB-M25	T1730242125-000	-	-	-	-	-	-
		M32		H24B-TBF-LB-M32	T1730242132-000	-	-	-	-	-	-
			PG21	H24B-TBFH-LB-PG21	T1770243121-000	-	-	-	-	-	-
			PG29	H24B-TBFH-LB-PG29	T1770243129-000	-	-	-	-	-	-
Protection Covers for Hoods				H24B-KDTP-LB	T1010241500-000	-	-	-	-	-	-
				H24B-KDTP	T1010241200-000			M25		H24B-TGBS-M25	T1260243125-000
Top Entry Housings with Two Levers			PG29	H24B-TGBS-PG29	T1260243129-000			M32		H24B-TGBS-M32	T1260243132-000
		M25		H24B-TGBS-M25	T1280243121-000			PG21		H24B-TGBHS-PG21	T1280243121-000
			PG29	H24B-TGBHS-PG29	T1280243129-000			PG29		H24B-TGBHS-PG29	T1280243129-000
		M25		H24B-TGBHS-M25	T1280243125-000			M25		H24B-TGBHS-M25	T1280243125-000
			PG29	H24B-TGBHS-M25	T1280243132-000			M32		H24B-TGBHS-M32	T1280243132-000
		M32		H24B-TGBHS-M32	T1280243132-000			M40		H24B-TGBHS-M40	T1280243140-000
			PG21	H24B-TGBS-PG21	T1260243121-000						
			PG29	H24B-TGBS-PG29	T1260243129-000						
			M25		H24B-TGBS-M25	T1260243125-000					
			M32		H24B-TGBS-M32	T1260243132-000					
Bulkhead Mounting with 4 Bolts				H24B-AD-BO	T1430240000-000					H24B-AD-BO	T1430240000-000
				H24B-ADM-BO	T1430241000-000					H24B-ADM-BO	T1430241000-000
Surface Mounting with protection cover			PG21	H24B-SDR-BO-PG21	T1460240121-000			M25		H24B-SDR-BO-M25	T1460240125-000
		M25		H24B-SDR-BO-M25	T1460240125-000			PG21		H24B-SGRM-BO-PG21	T1460241121-000
			PG21	H24B-SGRM-BO-PG21	T1460241121-000			M25		H24B-SGRM-BO-M25	T1460241125-000
		M25		H24B-SGRM-BO-M25	T1460241125-000			PG21		H24B-SDRH-BO-PG21	T1490240121-000
			PG21	H24B-SDRH-BO-PG21	T1490240121-000			M25		H24B-SDRH-BO-M25	T1490240125-000
		M25		H24B-SDRH-BO-M25	T1490240125-000			PG29		H24B-SDRH-BO-PG29	T1490240129-000
			PG29	H24B-SDRH-BO-PG29	T1490240129-000			M32		H24B-SDRH-BO-M32	T1490240132-000
		M32		H24B-SDRH-BO-M32	T1490240132-000			PG21		H24B-SDRHM-BO-PG21	T1490241121-000
			PG21	H24B-SDRHM-BO-PG21	T1490241121-000			PG29		H24B-SDRHM-BO-PG29	T1490241129-000
		M32		H24B-SDRHM-BO-M32	T1490241132-000			M32		H24B-SDRHM-BO-M32	T1490241132-000

Hoods & Housings





TE Connectivity's Heavy Duty Connectors

Hoods and Housings IP65

H32B with 2 Levers on the Hoods and Housings

H32B with 2 levers on the Hoods & Housings	Product Image	Metr.	PG	Type	PN	H32B with 1 levers on the Hoods & Housings	Product Image	Metr.	PG	Type	PN
Hoods: Side Entry		M20		H32B-TS-M20	T1210320120-000	Hoods: Side Entry			PG21	H32B-TS-RO-PG21	T1310320121-000
			PG21	H32B-TS-PG21	T1210320121-000				PG29	H32B-TS-RO-PG29	T1310320129-000
		M25		H32B-TS-M25	T1210320125-000			M32		H32B-TS-RO-M32	T1310320132-000
			PG29	H32B-TS-PG29	T1210320129-000				PG36	H32B-TS-RO-PG36	T1310320136-000
		M32		H32B-TS-M32	T1210320132-000			M40		H32B-TS-RO-M40	T1310320140-000
			PG36	H32B-TS-PG36	T1210320136-000			M50		H32B-TS-RO-M50	T1310320150-000
Hoods: Top Entry			PG21	H32B-TG-PG21	T1220320121-000	Hoods: Top Entry			PG21	H32B-TG-RO-PG21	T1320320121-000
		M25		H32B-TG-M25	T1220320125-000			M25		H32B-TG-RO-M25	T1320320125-000
			PG29	H32B-TG-PG29	T1220320129-000				PG29	H32B-TG-RO-PG29	T1320320129-000
		M32		H32B-TG-M32	T1220320132-000			M32		H32B-TG-RO-M32	T1320320132-000
			PG36	H32B-TG-PG36	T1220320136-000				PG36	H32B-TG-RO-PG36	T1320320136-000
		M40		H32B-TG-M40	T1220320140-000			M40		H32B-TG-RO-M40	T1320320140-000
			PG42	H32B-TG-PG42	T1220320142-000				PG42	H32B-TG-RO-PG42	T1320320142-000
			PG48	H32B-TG-PG48	T1220320148-000			M50		H32B-TG-RO-M50	T1320320150-000
Hoods: Side Entry with levers			PG21	H32B-TSB-PG21	T1250322121-000	Bulkhead Mounted		-	-	H32B-AG-LB	T1500322000-000
			PG29	H32B-TSB-PG29	T1250322129-000			-	-	H32B-AD-LB	T1510322000-000
Hoods: Top Entry with levers		M32		H32B-TGB-M32	T1260320132-000	Surface Mounted-Side Entry			PG29	H32B-SGR-LB-PG29	T1610322129-000
			PG36	H32B-TGB-PG36	T1260320136-000			M32		H32B-SGR-LB-M32	T1610322132-000
		M40		H32B-TGB-M40	T1260320140-000				PG36	H32B-SGR-LB-PG36	T1610322136-000
			PG21	H32B-TGB-PG21	T1260322121-000			M40		H32B-SGR-LB-M40	T1610322140-000
			PG29	H32B-TGB-PG29	T1260322129-000				PG42	H32B-SGR-LB-PG42	T1610322142-000
			PG42	H32B-TGB-PG42	T1260322142-000			M50		H32B-SGR-LB-M50	T1610322150-000
Bulkhead Mounted		-	-	H32B-AG	T1410322000-000	Surface Mounted-Side Entry			PG29	H32B-SDR-LB-PG29	T1620320129-000
		-	-	H32B-AG-BO	T1420320000-000				PG36	H32B-SDR-LB-PG36	T1620320136-000
		-	-	H32B-AD-BO	T1430320000-000			M40		H32B-SDR-LB-M40	T1620320140-000
Surface Mounted - Side Entry			PG29	H32B-SGR-PG29	T1440322129-000		PG42	H32B-SDR-LB-PG42	T1620320142-000		
		M32		H32B-SGR-M32	T1440322132-000	M50		H32B-SDR-LB-M50	T1620320150-000		
			PG36	H32B-SGR-PG36	T1440322136-000	M32		H32B-SDR-LB-M32	T1620322132-000		
		M40		H32B-SGR-M40	T1440322140-000						
			PG42	H32B-SGR-PG42	T1440322142-000						
			PG42	H32B-SGR-PG42	T1440322142-000						
Cable-to-Cable Hood			PG21	H32B-TBF-PG21	T1710322121-000						
			PG29	H32B-TBF-PG29	T1710322129-000						
		M32		H32B-TBF-M32	T1710322132-000						
			PG36	H32B-TBF-PG36	T1710322136-000						
		M40		H32B-TBF-M40	T1710322140-000						









H48B Metal Hoods and Housings

H48B metal Hoods and Housings	Product Image	Metr.	PG	Type	PN
Hoods: Side Entry		M25		H48B-TS-RO-M25	T1310480125-000
			PG29	H48B-TS-RO-PG29	T1310480129-000
		M32		H48B-TS-RO-M32	T1310480132-000
			PG36	H48B-TS-RO-PG36	T1310480136-000
		M40		H48B-TS-RO-M40	T1310480140-000
			PG42	H48B-TS-RO-PG42	T1310480142-000
		M50		H48B-TS-RO-M50	T1310480150-000
Hoods: Top Entry			PG29	H48B-TG-RO-PG29	T1320480129-000
		M32		H48B-TG-RO-M32	T1320480132-000
			PG36	H48B-TG-RO-PG36	T1320480136-000
		M40		H48B-TG-RO-M40	T1320480140-000
			PG42	H48B-TG-RO-PG42	T1320480142-000
		M50		H48B-TG-RO-M50	T1320480150-000
		M63		H48B-TG-RO-M63	T1320480163-000
Bulkhead Mounted		-	-	H48B-AG-LB	T1500482000-000
		-	-	H48B-AD-LB	T1510482000-000
Surface Mounted - Side Entry			PG29	H48B-SGR-LB-PG29	T1610482129-000
		M32		H48B-SGR-LB-M32	T1610482132-000
			PG36	H48B-SGR-LB-PG36	T1610482136-000
		M40		H48B-SGR-LB-M40	T1610482140-000
			PG42	H48B-SGR-LB-PG42	T1610482142-000
		M50		H48B-SGR-LB-M50	T1610482150-000
Surface Mounted with Cover			PG29	H48B-SDR-LB-PG29	T1620480129-000
		M32		H48B-SDR-LB-M32	T1620480132-000
			PG36	H48B-SDR-LB-PG36	T1620480136-000
		M40		H48B-SDR-LB-M40	T1620480140-000
			PG42	H48B-SDR-LB-PG42	T1620480142-000
		M50		H48B-SDR-LB-M50	T1620480150-000

TE Connectivity's Heavy Duty Connectors

Hoods and Housings IP65

EMC Hoods and Housings

EMC Hoods and Housings	Product Image	Metr.	PG	Type	PN	EMC Hoods and Housings	Product Image	Metr.	PG	Type	PN	
Hoods: Side Entry		M20		H6B-TS-M20-EMC	T1310065120-000	Hoods: Top Entry		M20		H10B-TG-RO-EMC-M20	T1325100120-000	
		M16		H10B-TS-RO-EMC-M16	T1315100016-000			M25		H10B-TG-RO-EMC-M25	T1325100125-000	
		M20		H10B-TS-RO-EMC-M20	T1315100120-000				PG16	H10B-TGH-EMC-PG16	T1240105116-000	
		M25		H10B-TS-RO-EMC-M25	T1315100125-000				PG21	H10B-TGH-EMC-PG21	T1240105121-000	
			PG13.5	H10B-TS-RO-EMC-PG13.5	T1315100113-000				PG29	H10B-TGH-EMC-PG29	T1240105129-000	
			PG16	H10B-TS-RO-EMC-PG16	T1315100116-000				M20	H10B-TGH-EMC-M20	T1240105120-000	
			PG21	H10B-TS-RO-EMC-PG21	T1315100121-000				M25	H10B-TGH-EMC-M25	T1240105125-000	
		M20		H10B-TSH-RO-EMC-M20	T1335100120-000				M32	H10B-TGH-EMC-M32	T1240105132-000	
		M25		H10B-TSH-RO-EMC-M25	T1335100125-000				M40	H10B-TGH-EMC-M40	T1240105140-000	
		M32		H10B-TSH-RO-EMC-M32	T1335100132-000					PG21	H10B-TGH-RO-EMC-PG21	T1345100121-000
			PG21	H10B-TSH-RO-EMC-PG21	T1335100121-000					PG29	H10B-TGH-RO-EMC-PG29	T1345100129-000
			PG29	H10B-TSH-RO-EMC-PG29	T1335100129-000				M25	H10B-TGH-RO-EMC-M25	T1345100125-000	
			PG16	H10B-TSH-EMC-PG16	T1230105116-000				M32	H10B-TGH-RO-EMC-M32	T1345100132-000	
			PG21	H10B-TSH-EMC-PG21	T1230105121-000					PG21	H16B-TGH-EMCS-PG21	T1130165121-000
			PG29	H10B-TSH-EMC-PG29	T1230105129-000					PG29	H16B-TGH-EMCS-PG29	T1130165129-000
		M20		H10B-TSH-EMC-M20	T1230105120-000				M25	H16B-TGH-EMCS-M25	T1130165125-000	
		M25		H10B-TSH-EMC-M25	T1230105125-000				M32	H16B-TGH-EMCS-M32	T1130165132-000	
		M32		H10B-TSH-EMC-M32	T1230105132-000						H10B-AGS-LB-EMC	T1505102000-000
		M40		H10B-TSH-EMC-M40	T1230105140-000						H10B-AGS-EMC	T1415103000-000
			PG21	H16B-TSH-EMC-PG21	T1230165121-000						H10B-AG-EMC	T1415102000-000
			PG29	H16B-TSH-EMC-PG29	T1230165129-000						H10B-AG-EMCS	T1695100000-000
		M25		H16B-TSH-EMC-M25	T1230165125-000						H10B-AG-SL-EMC	T1415104000-000
		M32		H16B-TSH-EMC-M32	T1230165132-000						H6B-AG-EMC	T1505063000-000
		M40		H16B-TSH-EMC-M40	T1230165140-000						H6B-AG-SL-EMC	T1505064000-000
			PG21	H16B-TSBHS-EMC-PG21	T1270165121-000						H16B-AG-EMCS	T1695160000-000
			PG29	H16B-TSBHS-EMC-PG29	T1270165129-000						H16B-AG-EMC	T1415162000-000
		M25		H16B-TSBHS-EMC-M25	T1270165125-000						H16B-AG-SL-EMC	T1415164000-000
		M32		H16B-TSBHS-EMC-M32	T1270165132-000						H16B-AGS-EMC	T1415163000-000
		M40		H16B-TSBHS-EMC-M40	T1270165140-000						H16B-AG-BO-EMC	T1425160000-000
			PG21	H24B-TSBHS-EMC-PG21	T1270245121-000						H24B-AG-BO-EMC	T1425240000-000
			PG29	H24B-TSBHS-EMC-PG29	T1270245129-000						H24B-AG-EMC	T1415242000-000
		M25		H24B-TSBHS-EMC-M25	T1270245125-000						H24B-AG-SL-EMC	T1415244000-000
		M32		H24B-TSBHS-EMC-M32	T1270245132-000	Bulkhead Mounted		M20		H3A-MTS-EMC-M20	T1319035120-100	
		M40		H24B-TSBHS-EMC-M40	T1270245140-000				PG11	H3A-MTG-EMC-PG11	T1329035111-100	
								M20		H3A-MTG-EMC-M20	T1329035120-100	
								-	-	H3A-MAG-EMC	T1506033000-000	
								-	-	H3A-MAGS-EMC	T1546033000-000	
								-	-	H3A-MAG-S-EMC	T1506032000-000	
								-	-	H3A-MTGV-B-M20-EMC	T1739035120-000	
								M25		H10A-TS-EMC-M25	T1317105125-000	
								-	-	H10A-ADMS-EMC	T1516101000-000	

Hoods & Housings





HB (IP65) Series Central lever locking

HB (IP65) Series Central lever locking	Product Image	Standard	Metr.	PG	Type	PN		
Hoods: Side Entry		H16B		PG21	H16B-TSH-RC-PG21	T1390160121-001		
				PG29	H16B-TSH-RC-PG29	T1390160129-001		
			M25		H16B-TSH-RC-M25	T1390160125-001		
			M32		H16B-TSH-RC-M32	T1390160132-001		
			M40		H16B-TSH-RC-M40	T1390160140-001		
		H24B				PG29	H24B-TSH-RCH-PG29	T1230246029-000
						PG29	H24B-TSH-RC-PG29	T1390240129-000
			M32				H24B-TSH-RC-M32	T1390240132-000
			M40				H24B-TSH-RC-M40	T1390240140-000
						PG21	H24B-TSH-RC-PG21	T1390240121-002
						PG29	H24B-TSH-RC-PG29	T1390240129-002
			M25				H24B-TSH-RC-M25	T1390240125-002
			M32				H24B-TSH-RC-M32	T1390240132-002
			M40				H24B-TSH-RC-M40	T1390240140-002
Bulkhead Mounted		H16B			H16B-AG-RC	T1550160000-001		
		H24B			H24B-AG-RC	T1550240000-000		
		H24BPRC			H24BPRC-KDBP	T1990240010-000		

TE Connectivity's Heavy Duty Connectors

Hoods and Housings IP68

H3APR (IP68) Hoods and Housings

H3APR (IP68) Series	Product Image	Metr.	PG	Type	PN
Hoods: Top entry			PG13.5	H3APR-MTGSW-PG13.5	T1927030113-000
		M20		H3APR-MTGSW-M20	T1927030120-000
Bulkhead Mounted				H3APR-MAGSW	T1937030000-000
				H3APR-MAGS	T1946030000-000
Hoods: Top entry		M16		H3APR-TGC-M16	T1926030116-000
		M20		H3APR-TGC-M20	T1926030120-000
Bulkhead Mounted				H3APR-AGC	T1936030000-000

Note: Please go to te.com for specific drawings and product size

HBPR (IP68) Hoods and Housings

HBPR (IP68) Series	Product Image	Standard	Metr.	PG	Type	PN
Hoods: Side Entry		H6BPR		PG16	H6BPR-TSH-PG16	T1910060116-000
			M20		H6BPR-TSH-M20	T1910060120-000
				PG21	H6BPR-TSH-PG21	T1910060121-000
			M25		H6BPR-TSH-M25	T1910060125-000
				PG29	H6BPR-TSH-PG29	T1910060129-000
				H6BPR-TSH-M32	T1910060132-000	
				H6BPR-TSH-M40	T1910060140-000	
		H10BPR		PG16	H10BPR-TSH-PG16	T1910100116-000
			M20		H10BPR-TSH-M20	T1910100120-000
				PG21	H10BPR-TSH-PG21	T1910100121-000
			M25		H10BPR-TSH-M25	T1910100125-000
			PG29	H10BPR-TSH-PG29	T1910100129-000	
				H10BPR-TSH-M32	T1910100132-000	
		H16BPR		PG21	H16BPR-TSH-PG21	T1910160121-000
			M25		H16BPR-TSH-M25	T1910160125-000
				PG29	H16BPR-TSH-PG29	T1910160129-000
			M32		H16BPR-TSH-M32	T1910160132-000
			PG36	H16BPR-TSH-PG36	T1910160136-000	
				H16BPR-TSH-M40	T1910160140-000	
		H24BPR		PG21	H24BPR-TSH-PG21	T1910240121-000
			M25		H24BPR-TSH-M25	T1910240125-000
				PG29	H24BPR-TSH-PG29	T1910240129-000
			M32		H24BPR-TSH-M32	T1910240132-000
				PG36	H24BPR-TSH-PG36	T1910240136-000
			M40		H24BPR-TSH-M40	T1910240140-000
					H24BPR-TSH-M50	T1910240150-000
			M32		H24BPR-TSH-XL-M32	T1910240132-002
			M40		H24BPR-TSH-XL-M40	T1910240140-002
M50			H24BPR-TSH-XL-M50	T1910240150-002		
M63			H24BPR-TSH-XL-M63	T1910240163-002		
	PG29		H24BPR-TSH-XL-PG29	T1910240129-002		
	PG42		H24BPR-TSH-XL-PG42	T1910240136-002		
	PG42	H24BPR-TSH-XL-PG42	T1910240142-002			
	PG48	H24BPR-TSH-XL-PG48	T1910240148-002			
Hoods: Top Entry		H6BPR	M20	PG16	H6BPR-TGH-PG16	T1920060116-000
					H6BPR-TGH-M20	T1920060120-000
				PG21	H6BPR-TGH-PG21	T1920060121-000
			M25		H6BPR-TGH-M25	T1920060125-000
			PG29	H6BPR-TGH-PG29	T1920060129-000	
				H6BPR-TGH-M32	T1920060132-000	
		H10BPR		PG16	H10BPR-TGH-PG16	T1920100116-000
			M20		H10BPR-TGH-M20	T1920100120-000
				PG21	H10BPR-TGH-PG21	T1920100121-000
			M25		H10BPR-TGH-M25	T1920100125-000
				PG29	H10BPR-TGH-PG29	T1920100129-000
				H10BPR-TGH-M32	T1920100132-000	
				H10BPR-TGH-M40	T1920100140-000	
		H16BPR		PG21	H16BPR-TGH-PG21	T1920160121-000
			M25		H16BPR-TGH-M25	T1920160125-000
				PG29	H16BPR-TGH-PG29	T1920160129-000
			M32		H16BPR-TGH-M32	T1920160132-000
				PG36	H16BPR-TGH-PG36	T1920160136-000
			M40		H16BPR-TGH-M40	T1920160140-000
				H16BPR-TGXH-M50	T1920160150-001	
				H16BPR-TGXH-M63	T1920160163-001	
		H24BPR		PG21	H24BPR-TGH-PG21	T1920240121-000
			M25		H24BPR-TGH-M25	T1920240125-000
				PG29	H24BPR-TGH-PG29	T1920240129-000
			M32		H24BPR-TGH-M32	T1920240132-000
				PG36	H24BPR-TGH-PG36	T1920240136-000
			M40		H24BPR-TGH-M40	T1920240140-000
					H24BPR-TGXH-M50	T1920240150-001
			M63		H24BPR-TGXH-M63	T1920240163-001
			M32		H24BPR-TGH-XL-M32	T1920240132-002
M40			H24BPR-TGH-XL-M40	T1920240140-002		
M50			H24BPR-TGH-XL-M50	T1920240150-002		
M63			H24BPR-TGH-XL-M63	T1920240163-002		
	PG29		H24BPR-TGH-XL-PG29	T1920240129-002		
	PG42	H24BPR-TGH-XL-PG42	T1920240136-002			
	PG42	H24BPR-TGH-XL-PG42	T1920240142-002			
	PG48	H24BPR-TGH-XL-PG48	T1920240148-002			
H32BPR	M63		H32BPR-TGXH-4S-M63	T1926320163-001		
	M50		H32BPR-TGXH-4S-M50	T1926320150-001		

TE Connectivity's Heavy Duty Connectors

Hoods and Housings IP68

HBPR (IP68) Hoods and Housings

HBPR (IP68) Series	Product Image	Standard	Metr.	PG	Type	PN
Bulkhead Mounted		H6BPR	-		H6BPR-AG	T1930060000-000
		H10BPR			H10BPR-AG	T1930100000-000
		H16BPR			H16BPR-AG	T1930160000-000
		H24BPR			H24BPR-AG	T1930240000-000
		H32BPR			H32BPR-AG-4S	T1936320000-000
		H32BPR			H32BPR-AG-4S	T1936322000-000
Straight Surface Mounte		H10BPR		PG21	H10BPR-SGRH-PG21	T1950100121-000
			M25		H10BPR-SGRH-M25	T1950100125-000
				PG29	H10BPR-SGRH-PG29	T1950100129-000
			M32		H10BPR-SGRH-M32	T1950100132-000
		H16BPR		PG21	H16BPR-SGRH-PG21	T1950160121-000
				PG29	H16BPR-SGRH-PG29	T1950160129-000
				PG36	H16BPR-SGRH-PG36	T1950160136-000
			M25		H16BPR-SGRH-M25	T1950160125-000
			M32		H16BPR-SGRH-M32	T1950160132-000
			M40		H16BPR-SGRH-M40	T1950160140-000
		H24BPR	M25		H24BPR-SGRH-2TM25	T1950240225-000
			M32		H24BPR-SGRH-2TM32	T1950240232-000
			M40		H24BPR-SGRH-2TM40	T1950240240-000
			M25		H24BPR-SGRH-3TM25	T1950240325-000
			M32		H24BPR-SGRH-3TM32	T1950240332-000
Cover		H6BPR	-		H6BPR-KDBM	T1990060000-000
		H10BPR			H10BPR-KDBM	T1990100000-000
		H16BPR			H16BPR-KDBM	T1990160000-000
		H24BPR			H24BPR-KDBM	T1990240000-000

HBPR (IP68) Series Central locking

HBPR (IP68) Series Central locking	Product Image	Standard	Metr.	PG	Type	PN
Hoods: Side Entry		H6BPR		PG16	H6BPR-TSHC-PG16	T1912060116-000
			M20		H6BPR-TSHC-M20	T1912060120-000
				PG21	H6BPR-TSHC-PG21	T1912060121-000
			M25		H6BPR-TSHC-M25	T1912060125-000
		H10BPR		PG16	H10BPR-TSHC-PG16	T1912100116-000
			M20		H10BPR-TSHC-M20	T1912100120-000
				PG21	H10BPR-TSHC-PG21	T1912100121-000
			M25		H10BPR-TSHC-M25	T1912100125-000
				PG29	H10BPR-TSHC-PG29	T1912100129-000
		H16BPR	M32		H10BPR-TSHC-M32	T1912100132-000
			M25		H16BPR-TSHC-M25	T1912160125-000
				PG29	H16BPR-TSHC-PG29	T1912160129-000
		H24BPR	M32		H16BPR-TSHC-M32	T1912160132-000
			M40		H16BPR-TSHC-M40	T1912160140-000
				PG21	H24BPR-TSHC-PG21	T1912240121-000
			M25		H24BPR-TSHC-M25	T1912240125-000
	PG29		H24BPR-TSHC-PG29	T1912240129-000		
Hoods: Top Entry		H6BPR		PG16	H6BPR-TGHC-PG16	T1922060116-000
			M20		H6BPR-TGHC-M20	T1922060120-000
				PG21	H6BPR-TGHC-PG21	T1922060121-000
			M25		H6BPR-TGHC-M25	T1922060125-000
				PG29	H6BPR-TGHC-PG29	T1922060129-000
		H10BPR	M32		H6BPR-TGHC-M32	T1922060132-000
			M40		H6BPR-TGHC-M40	T1922060140-000
				PG16	H10BPR-TGHC-PG16	T1922100116-000
			M20		H10BPR-TGHC-M20	T1922100120-000
				PG21	H10BPR-TGHC-PG21	T1922100121-000
		H16BPR	M25		H10BPR-TGHC-M25	T1922100125-000
				PG29	H10BPR-TGHC-PG29	T1922100129-000
			M32		H10BPR-TGHC-M32	T1922100132-000
				PG21	H16BPR-TGHC-PG21	T1922160121-000
			M25		H16BPR-TGHC-M25	T1922160125-000
		H24BPR		PG29	H16BPR-TGHC-PG29	T1922160129-000
M32			H16BPR-TGHC-M32	T1922160132-000		
	PG36		H16BPR-TGHC-PG36	T1922160136-000		
M40			H16BPR-TGHC-M40	T1922160140-000		
	PG21		H24BPR-TGHC-PG21	T1922240121-000		
Bulkhead Mounted		H6BPR			H6BPR-AGC	T1932060000-000
		H10BPR			H10BPR-AGC	T1932100000-000
		H16BPR			H16BPR-AGC	T1932160000-000
		H24BPR			H24BPR-AGC	T1932240000-000
Cover		H24BPR			H24BPRC-KDBP	T1990240010-000

Hoods & Housings

Metal Cable Glands - Brass Nicked-plated

Metal cable glands - brass nicked-plated	Product Image	Metr.	PG	Clamp Range	Type	PN		
<p>Material: Nickel plated brass Press seal material: PA Seal material: NBR Temperature range: -40°C + 100°C Protection: IP68</p>			PG7	3-6.5	DLX-7-MS	T3609070101-000		
				2-5	DLX-7-MTS	T3609070111-000		
			PG9	4-8	DLX-9-MS	T3609090101-000		
				2-6	DLX-9-MTS	T3609090111-000		
			PG11	5-10	DLX-11-MS	T3609110101-000		
				3-7	DLX-11-MTS	T3609110111-000		
			PG13	6-12	DLX-13-MS	T3609130101-000		
				5-9	DLX-13-MTS	T3609130111-000		
			PG16	10-14	DLX-16-MS	T3609160101-000		
				7-12	DLX-16-MTS	T3609160111-000		
			PG21	13-18	DLX-21-MS	T3609210101-000		
				9-16	DLX-21-MTS	T3609210111-000		
			PG29	18-25	DLX-29-MS	T3609290101-000		
				13-20	DLX-29-MTS	T3609290111-000		
			PG36	22-32	DLX-36-MS	T3609360101-000		
				20-26	DLX-36-MTS	T3609360111-000		
			PG42	32-38	DLX-42-MS	T3609420101-000		
				25-31	DLX-42-MTS	T3609420111-000		
			PG48	37-44	DLX-48-MS	T3609480101-000		
				29-35	DLX-48-MTS	T3609480111-000		
			M12 * 1.5			3-6.5	DLX-12-M	T3609120102-000
						2-5	DLX-12-MT	T3609120112-000
			M16 * 1.5			4-8	DLX-16-M	T3609160102-000
						2-6	DLX-16-MT	T3609160112-000
						5-10	DLX-16-MB	T3609160122-000
			M20 * 1.5			6-12	DLX-20-M	T3609200102-000
						5-9	DLX-20-MT	T3609200112-000
						10-14	DLX-20-MB	T3609200122-000
			M25 * 1.5			13-18	DLX-25-M	T3609250102-000
						9-16	DLX-25-MT	T3609250112-000
			M32 * 1.5			18-25	DLX-32-M	T3609320102-000
						13-20	DLX-32-MT	T3609320112-000
			M40 * 1.5			22-32	DLX-40-M	T3609400102-000
							DLX-40-M	T3609400102-001
						20-26	DLX-40-MT	T3609400112-000
			M50 * 1.5			32-38	DLX-50-M	T3609500102-000
DLX-50-M	T3609500102-001							
25-31	DLX-50-MT	T3609500112-000						
29-36	DLX-50-M	T3609500122-000						
M63 * 1.5			37-44	DLX-63-M	T3609630102-000			
			29-35	DLX-63-MT	T3609630112-000			

Nylon Cable Glands - Nylon Sealing Insert

Nylon cable glands - nylon sealing insert	Product Image	Metr.	PG	Clamp Range	Type	PN
Material: PA Press seal material: PA Seal material: EPDM Temperature range: -40°C + 100°C Protection: IP68			PG7	3-6.5	HSK-P07G	T3209071201-000
			PG9	2.5-6	HSK-P09G-H	T3209091211-000
				4-8	HSK-P09G	T3209091201-000
			PG11	5-10	HSK-P11G	T3209111201-000
			PG13.5	6-12	HSK-P13.5G-H	T3209131211-000
				6-12	HSK-P13.5G	T3209131201-000
			PG16	6-12	HSK-P16G-H	T3209161211-000
				8-14	HSK-P16G	T3209161201-000
			PG21	11-16	HSK-P21G-H	T3209211211-000
				13-18	HSK-P21G	T3209211201-000
		PG29	14-21	HSK-P29G-H	T3209291211-000	
			18-25	HSK-P29G	T3209291201-000	
		PG36	22-32	HSK-P36G	T3209361201-000	
		PG42	30-38	HSK-P42G	T3209421201-000	
		PG48	37-44	HSK-P48G	T3209481201-000	
		M12*1.5		3-6.5	HSK-M12G	T3209121222-001
		M16*1.5		2.5-6	HSK-M16G-H	T3209161212-001
				4-8	HSK-M16G	T3209161222-001
		M18*1.5		5-10	HSK-M16G-D	T3209161202-001
		M20*1.5		5-10	HSK-M18G	T3209181222-001
				5-9	HSK-M20G-H	T3209201212-001
				6-12	HSK-M20G	T3209201222-001
		M22*1.5		8-14	HSK-M20G-D	T3209201202-001
				6-12	HSK-M22G-H	T3209221212-001
		M24*1.5		8-14	HSK-M22G	T3209221222-001
				6-12	HSK-M24G-H	T3209241212-001
		M25*1.5		8-14	HSK-M24G	T3209241222-001
				11-16	HSK-M25G-H	T3209251212-001
		M27*2.0		13-18	HSK-M25G	T3209251222-001
				11-16	HSK-M27G-H	T3209271212-001
		M30*2.0		13-18	HSK-M27G	T3209271222-001
				11-16	HSK-M30G-H	T3209301212-001
		M32*1.5		13-18	HSK-M30G	T3209301222-001
				14-21	HSK-M32G-H	T3209321212-001
		M33*2.0		18-25	HSK-M32G	T3209321222-001
				18-25	HSK-M33G	T3209331222-001
		M36*2.0		14-21	HSK-M36G-H	T3209361212-001
				18-25	HSK-M36G	T3209361222-001
		M40*1.5		22-32	HSK-M40G	T3209401222-001
				22-32	HSK-M42G	T3209421222-001
M48*2.0		22-32	HSK-M48G	T3209481222-001		
		30-38	HSK-M50G	T3209501222-001		
M50*1.5		31-41	HSK-M50G-D	T3209501202-001		

TE Connectivity's Heavy Duty Connectors

Cable Glands

Nylon cable glands - nylon sealing insert	Product Image	Metr.	PG	Clamp Range	Type	PN
<p>Material: PA Press seal material: PA Seal material: EPDM Temperature range: -40°C + 100°C Protection: IP68</p> 	M56*2.0			30-38	HSK-M56G	T3209561222-001
	M60*2.0			37-44	HSK-M60G	T3209601222-001
	M63*1.5			37-44	HSK-M63G	T3209631222-001
	M64*2.0			37-44	HSK-M64G	T3209641222-001
	M72*2.0			43-53	HSK-M72G-H	T3209721212-001
				51-57	HSK-M72G	T3209721222-001
	M12*1.5			3-6.5	HSK-M12B	T3209121122-001
	M16*1.5			2.5-6	HSK-M16B-H	T3209161112-001
				4-8	HSK-M16B	T3209161122-001
				5-10	HSK-M16B-D	T3209161102-001
	M18*1.5			5-10	HSK-M18B	T3209181122-001
	M20*1.5			9-5	HSK-M20B-H	T3209201112-001
				6-12	HSK-M20B	T3209201122-001
				8-14	HSK-M20B-D	T3209201102-001
	M22*1.5			6-12	HSK-M22B-H	T3209221112-001
				8-14	HSK-M22B	T3209221122-001
	M24*1.5			6-12	HSK-M24B-H	T3209241112-001
				8-14	HSK-M24B	T3209241122-001
	M25*1.5			11-16	HSK-M25B-H	T3209251112-001
				13-18	HSK-M25B	T3209251122-001
	M27*2.0			11-16	HSK-M27B-H	T3209271112-001
				13-18	HSK-M27B	T3209271122-001
	M30*2.0			11-16	HSK-M30B-H	T3209301112-001
				13-18	HSK-M30B	T3209301122-001
	M32*1.5			14-21	HSK-M32B-H	T3209321112-001
				18-25	HSK-M32B	T3209321122-001
	M33*2.0			18-25	HSK-M33B	T3209331122-001
	M36*2.0			14-21	HSK-M36B-H	T3209361112-001
				18-25	HSK-M36B	T3209361122-001
	M40*1.5			22-32	HSK-M40B	T3209401122-001
	M42*2.0			22-32	HSK-M42B	T3209421122-001
	M48*2.0			22-32	HSK-M48B	T3209481122-001
	M50*1.5			30-38	HSK-M50B	T3209501122-001
				31-41	HSK-M50B-D	T3209501102-001
	M56*2.0			30-38	HSK-M56B	T3209561122-001
	M60*2.0			37-44	HSK-M60B	T3209601122-001
	M63*1.5			37-44	HSK-M63B	T3209631122-001
	M64*2.0			37-44	HSK-M64B	T3209641122-001
	M72*2.0			43-53	HSK-M72B-H	T3209721112-001
				51-57	HSK-M72B	T3209721122-001
		PG21		VA-21-MS	T3900210001-000	
M25				VA-25-M	T3900250050-000	

Metal Cable Glands - Multiple Sealing Insert

Multiple sealing insert metal cable gland	Product Image	Metr.	PG	Clamp Range	Type	PN
Material: Nickel plated brass Seal material: TPE/EPDM Temperature range: -40°C + 100°C Protection: IP65 Seal material colors: White (other colors need consulting)			PG21	2*6	DLX-21-3KMS	T3729210301-000
			PG29	4*9	DLX-29-MS 4*9	T3729290201-000
			PG29	3*10	DLX-29-MS 3*10	T3729290401-000
		M20		3*4	DLX-20-KM	T3729200102-000
		M25		4*6	DLX-25-1KM	T3729250102-000
		M25		2*6	DLX-25-3KM	T3729250302-000
		M25		2*8	DLX-25-4KM	T3729250402-000
		M32		6*6.5	DLX-32-1KM	T3729320102-000
		M32		4*9	DLX-32-2KM	T3729320202-000
		M40		5*9	DLX-40-1KM	T3729400102-000
Multiple sealing insert nylon cable gland Material: PA Seal material: EPDM Temperature range: -40°C + 100°C Protection: IP65 Seal material colors: White (other colors need consulting)			PG16	2*6	DLX-16-KPMS	T3229160201-000
			PG21	2*8	DLX-21-4KPMS	T3229210401-000
			PG29	4*9	DLX-29-2KPMS	T3229290201-000
			PG36	5*9	DLX-36-1KPMS	T3229360101-000
		M16		2*3	DLX-16-KPM	T3229160102-000
		M20		2*5	DLX-20-KPM	T3229200202-000
		M25		4*6	DLX-25-1KPM	T3229250102-000
		M25		2*6	DLX-25-3KPM	T3229250302-000
		M25		2*8	DLX-25-4KPM	T3229250402-000
		M32		4*9	DLX-32-2KPM	T3229320202-000

Special Sealing Insert Glands

Special sealing insert glands	Product Image	Metr.	PG	Name	Type	PN		
Sealing with Different Color Material: Nickel plated brass Seal material: TPE/EPDM Temperature range: -40°C + 100°C Protection: IP65 Seal material colors: Black (other colors need consulting)			PG9	6.5-9	DLX-9-MSE	T3709090101-000		
			PG9	3.5-6	DLX-9-MSET	T3709090111-000		
			PG11	6-8.5	DLX-11-MSET	T3709110111-000		
			PG11	8.5-11	DLX-11-MSEZ	T3709110121-000		
			PG13.5	13.5-15	DLX-13-MSE	T3709130101-000		
			PG13.5	8.5-11	DLX-13-MSET	T3709130111-000		
			PG13.5	11-13.5	DLX-13-MSEZ	T3709130121-000		
			PG16	14-16	DLX-16-MSE	T3709160101-000		
			PG16	9-12	DLX-16-MSET	T3709160111-000		
			PG16	12-14	DLX-16-MSEZ	T3709160121-000		
			PG21	17.5-19	DLX-21-MSE	T3709210101-000		
			PG21	13.5-16	DLX-21-MSET	T3709210111-000		
			PG21	16-17.5	DLX-21-MSEZ	T3709210121-000		
			PG29	22.5-25	DLX-29-MSE	T3709290101-000		
			PG29	17.5-21	DLX-29-MSET	T3709290111-000		
			PG29	21-22.5	DLX-29-MSEZ	T3709290121-000		
			M16*1.5			9.5-10.5	DLX-16-ME	T3709160102-000
			M16*1.5			6.5-8	DLX-16-MET	T3709160112-000
			M16*1.5			8-9.5	DLX-16-MEZ	T3709160122-000
			M20*1.5			13.5-15	DLX-20-ME	T3709200102-000
	M20*1.5			8.5-11	DLX-20-MET	T3709200112-000		
	M20*1.5			11-13.5	DLX-20-MEZ	T3709200122-000		
	M24*1.5			10-14	DLX-24-MET	T3709240112-000		
	M25*1.5			17.5-19	DLX-25-ME	T3709250102-000		
	M25*1.5			13.5-16	DLX-25-MET	T3709250112-000		
	M25*1.5			16-17.5	DLX-25-MEZ	T3709250122-000		
	M25*1.5			19-21	DLX-25-MEC	T3709250142-000		
	M32*1.5			22.5-25	DLX-32-ME	T3709320102-000		
	M32*1.5			17-21	DLX-32-MET	T3709320112-000		
	M32*1.5			21-22.5	DLX-32-MEZ	T3709320122-000		
EMC cable glands Material: Nickel plated brass Press Seal Material: PA Temperature range: -40°C + 100°C Protection: IP68			PG11	5-10	DLX-11-MS	T3706110203-000		
			PG16	10-14	DLX-16-MS	T3707160101-000		
			PG21	13-18	DLX-21-MS	T3707210101-000		
			PG29	17-24	DLX-29-MS	T3707290101-000		
		M16			4-8	DLX-16-MC	T3707160103-000	
		M20			5-9	DLX-20-MTC	T3707200113-000	
		M20			7-12	DLX-20-MC	T3706200103-000	
		M25			11-16	DLX-25-MTC	T3707250113-000	
		M25			13-18	DLX-25-MC	T3609250103-000	
		M32			15-21	DLX-32-MTC	T3707320113-000	
		M32			18-25	DLX-32-MC	T3609320103-000	
		M32			18-25	DLX-32-MC	T3707320103-000	
		M40			22-30	DLX-40-MTC	T3707400113-000	
		M40			22-32	DLX-40-MC	T3706400103-000	
		M50			30-38	DLX-50-MC	T3707500103-000	
		M63			37-44	DLX-63-MC	T3707630103-000	

Metal Glands with Multiple Seal

Metal glands with multiple seal	Product Image	Metr.	PG	Clamp Range	Type	PN
Material: Nickel plated brass Seal Material: NBR Temperature range: -40°C + 100°C Protection: IP65			PG9	5-10	DSM-9	T3201090101-000
			PG11	7-12	DSM-11	T3201110101-000
			PG13.5	7-12	DSM-13	T3201130101-000
			PG16	7-15	DSM-16	T3201160101-000
			PG21	10-19	DSM-21	T3201210101-000
			PG29	18-27	DSM-29	T3201290101-000
			PG36	24-32	DSM-36	T3201360101-000
			PG42	30-39	DSM-42	T3201420101-000
			PG48	36-45	DSM-48	T3201480101-000
		M12		5-10	DSM-12-M	T3201120102-000
		M16		6.5-10	DSM-16-M	T3201160102-000
		M20		8.5-13.5	DSM-20-M	T3201200102-000
		M25		13-20	DSM-25-M	T3201250102-000
		M32		19-28	DSM-32-M	T3201320102-000
Material: Nickel plated brass Seal Material: NBR Temperature range: -40°C + 100°C Protection: IP54			PG9	8-10	DSM-9-S	T3211090101-000
			PG11	10-12	DSM-11-S	T3211110101-000
			PG13.5	12-14	DSM-13-S	T3211130101-000
			PG16	14-16	DSM-16-S	T3211160101-000
			PG21	17-19	DSM-21-S	T3211210101-000
			PG29	23-25	DSM-29-S	T3211290101-000
			PG36	33-35	DSM-36-S	T3211360101-000
			PG42	39-41	DSM-42-S	T3211420101-000
			PG48	45-47	DSM-48-S	T3211480101-000
		M12		5-7	DSM-12-SM	T3211120102-000
		M16		8-10	DSM-16-SM	T3211160102-000
		M20		10-12	DSM-20-SM	T3211200102-000
		M25		15-17	DSM-25-SM	T3211250102-000
		M32		24-26	DSM-32-SM	T3211320102-000

TE Connectivity's Heavy Duty Connectors

Cable Glands

Metal Glands with Multiple Seal

Metal glands with multiple seal	Product Image	Metr.	PG	Clamp Range	Type	PN
Material: Nickel plated brass Seal Material: NBR Temperature range: -40°C + 100°C Protection: IP65			PG9	5-10	DSM-9	T3101090101-000
			PG11	7-12	DSM-11	T3101110101-000
			PG13.5	7-12	DSM-13	T3101130101-000
			PG16	7-15	DSM-16	T3101160101-000
			PG21	10-19	DSM-21	T3101210101-000
			PG29	18-27	DSM-29	T3101290101-000
			PG36	24-32	DSM-36	T3101360101-000
			PG42	30-39	DSM-42	T3101420101-000
			PG48	36-45	DSM-48	T3101480101-000
		M12		5-10	DSM-12-M	T3201120102-000
		M16		6.5-10	DSM-16-M	T3101160102-000
		M20		8.5-13.5	DSM-20-M	T3101200102-000
		M25		13-20	DSM-25-M	T3101250102-000
M32		19-28	DSM-32-M	T3101320102-000		
Material: Nickel plated brass Seal Material: NBR Temperature range: -40°C + 100°C Protection: IP54			PG9	8-10	DSM-9-S	T3111090101-000
			PG11	10-12	DSM-11-S	T3111110101-000
			PG13.5	12-14	DSM-13-S	T3111130101-000
			PG16	14-16	DSM-16-S	T3111160101-000
			PG21	17-19	DSM-21-S	T3111210101-000
			PG29	23-25	DSM-29-S	T3111290101-000
			PG36	33-35	DSM-36-S	T3111360101-000
			PG42	39-41	DSM-42-S	T3111420101-000
			PG48	45-47	DSM-48-S	T3111480101-000
		M12		5-7	DSM-12-SM	T321120102-000
		M16		8-10	DSM-16-SM	T3111160102-000
		M20		10-12	DSM-20-SM	T3111200102-000
		M25		15-17	DSM-25-SM	T3111250102-000
M32		24-26	DCSM-32-SM	T3111320102-000		



Metal Clamp Glands with Multiple Seal

Metal clamp glands with multiple seal	Product Image	Metr.	PG	Clamp Range	Type	PN
Material: Nickel plated brass Seal Material: NBR Temperature range: -40°C + 100°C Protection: IP65			PG9	6.5-10	ZSM-9	T3135090101-000
			PG11	7.5-12	ZSM-11	T3135110101-000
			PG13.5	8.5-13.5	ZSM-13	T3135130101-000
			PG16	10.5-16	ZSM-16	T3135160101-000
			PG21	13-20	ZSM-21	T3135210101-000
			PG29	19-28	ZSM-29	T3135290101-000
			PG36	24-34	ZSM-36	T3135360101-000
			PG42	34-40	ZSM-42	T3135420101-000
			PG48	39-46	ZSM-48	T3135480101-000
			M16	6.5-10	ZSM-16-M	T3135160121-000
			M20	7.5-12	ZSM-20-M	T3135200121-000
			M25	13-20	ZSM-25-M	T3135250121-000
			M32	19-28	ZSM-32-M	T3135320121-000
			M40	24-34	ZSM-40-M	T3135400121-000
	M50	34-40	ZSM-50-M	T3135500121-000		
	M63	39-46	ZSM-63-M	T3135630121-000		
Metal clamp glands with normal seal Material: Nickel plated brass Seal Material: NBR Temperature range: -40°C + 100°C Protection: IP54			PG9	8-10	ZSM-9-S	T3115090101-000
			PG11	10-12	ZSM-11-S	T3115110101-000
			PG13.5	12-14	ZSM-13-S	T3115130101-000
			PG16	14-16	ZSM-16-S	T3115160101-000
			PG21	17-19	ZSM-21-S	T3115210101-000
			PG29	26-28	ZSM-29-S	T3115290101-000
			PG36	33-35	ZSM-36-S	T3115360101-000
			PG42	39-41	ZSM-42-S	T3115420101-000
			PG48	43-45	ZSM-48-S	T3115480101-000
			M16	6-8	ZSM-16-SM	T3115160121-000
			M20	8-12	ZSM-20-SM	T3115200121-000
			M25	12-14	ZSM-25-SM	T3115250121-000
			M32	17-19	ZSM-32-SM	T3115320121-000
			M40	25-27	ZSM-40-SM	T3115400121-000
	M50	39-41	ZSM-50-SM	T3115500121-000		
	M63	43-45	ZSM-63-SM	T3115630121-000		





Metal Clamp Glands

Metal clamp glands	Product Image	Metr.	PG	Clamp Range	Type	PN
Material: Nickel plated brass Temperature range: -40°C + 100°C			PG9	6.5-10	KSM-9-MS	T3105090101-000
			PG11	7.5-12	KSM-11-MS	T3105110101-000
			PG13.5	8.5-14	KSM-13-MS	T3105130101-000
			PG16	9.5-16	KSM-16-MS	T3105160101-000
			PG21	12-21	KSM-21-MS	T3105210101-000
			PG29	19-30	KSM-29-MS	T3105290101-000
			PG36	25-37	KSM-36-MS	T3105360101-000
			PG42	31-43	KSM-42-MS	T3105420101-000
			PG48	35-48	KSM-48-MS	T3105480101-000
			M16	7-10	KSM-16-M	T3105160121-000
			M32	16-27	KSM-32-M	T3105320121-000
	M40	23-33	KSM-40-M	T3105400121-000		

Metal Lock Nuts

Metal lock nuts	Product Image	Metr.	PG	Type	PN	
Material: Nickel plated brass Temperature range: -40°C + 100°C			PG7	LN-7-MS	T3161070001-000	
			PG9	LN-9-MS	T3161090001-000	
			PG11	LN-11-MS	T3161110001-000	
			PG13	LN-13-MS	T3161130001-000	
			PG16	LN-16-MS	T3161160001-000	
			PG21	LN-21-MS	T3161210001-000	
			PG29	LN-29-MS	T3161290001-000	
			PG36	LN-36-MS	T3161360001-000	
			PG42	LN-42-MS	T3161420001-000	
			PG48	LN-48-MS	T3161480001-000	
		M12			LN-12-M	T3161120050-000
		M16			LN-16-M	T3161160050-000
		M20			LN-20-M	T3161200050-000
		M25			LN-25-M	T3161250050-000
		M27			LN-27-M	T3161270051-000
		M28			LN-28-M	T3161280001-000
		M32			LN-32-M	T3161320050-000
		M40			LN-40-M	T3161400050-000
		M50			LN-50-M	T3161500050-000
M63			LN-63-M	T3161630050-000		
Nylon lock nuts Material: PA Temperature range: -40°C + 100°C			PG7	LN-7-P	T3262070001-000	
			PG9	LN-9-P	T3162090001-000	
			PG11	LN-11-P	T3262110001-100	
			PG13.5	LN-13-P	T3262130001-100	
			PG16	LN-16-P	T3262160001-100	
			PG21	LN-21-P	T3262210001-100	
			PG29	LN-29-P	T3262290001-100	
			PG36	LN-36-P	T3262360001-000	
			PG42	LN-42-P	T3262420001-000	
			PG48	LN-48-P	T3262480001-000	
		M12			LN-12-PM	T3262120050-000
		M16			LN-16-PM	T3262160050-000
		M20			LN-20-PM	T3262200050-100
		M25			LN-25-PM	T3262250050-000
		M32			LN-32-PM	T3262320050-100
		M40			LN-40-PM	T3262400050-000
		M50			LN-50-PM	T3262500050-000
		M60			LN-60-PM	T3262600050-000
		M63			LN-63-PM	T3262630050-000
				PG16	LN-16-BP	T3262160001-200
				PG21	LN-21-BP	T3262210001-200
				PG29	LN-29-BP	T3262290001-200
		M16			LN-16-BPM	T3262160050-200
		M20			LN-20-BPM	T3262200050-200
		M25			LN-25-BPM	T3262250050-200
		M32			LN-32-BPM	T3262320050-200

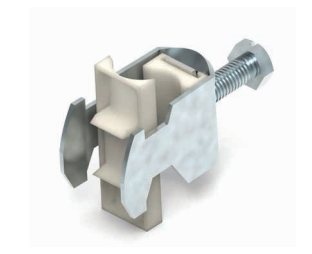
Metal Increase

Metal increase	Product Image	Metr.	PG	Clamp Range	Type	PN		
			PG9-PG11		INCR-9/11-PG	T3033091101-000		
			PG11-PG13.5		INCR-11/13.5-PG	T3033111301-000		
			PG13.5-PG16		INCR-13.5/16-PG	T3033131601-000		
			PG16-PG21		INCR-16/21-PG	T3033162102-000		
			PG21-PG29		INCR-21/29-PG	T3033212902-000		
			PG29-PG36		INCR-29/36-PG	T3033293601-000		
			PG36-PG42		INCR-36/42-PG	T3033364201-000		
			M12-M16		INCR-12/16-M	T3033121650-000		
			M16-M20		INCR-16/20-M	T3033162050-000		
			M16-PG11		INCR-M16-PG11	T3033161150-000		
			M16-PG16		INCR-M16-PG16	T3168161612-000		
			M20-M25		INCR-20/25-M	T3033202550-000		
			M20-PG16		INCR-M20-PG16	T3168201612-000		
			M25-PG21		INCR-M25-PG21	T3033252150-000		
			M25-PG29		INCR-M25-PG29	T3033252950-000		
			M25-M32		INCR-25/32-M	T3033253250-000		
			M32-PG29		INCR-M32-PG29	T3033322950-000		
			M32-M40		INCR-32/40-M	T3033324050-000		
			M40-M50		INCR-40/50-M	T3033405050-000		
			M50-M63		INCR-50/63-M	T3033506350-000		
					PG11-PG7		REDU-11/7-PG	T3071110701-000
					PG11-PG9		REDU-11/9-PG	T3071110901-000
					PG11-M16		REDU-PG11-M16	T3071111601-000
					PG13.5-PG11		REDU-13/11-PG	T3071131101-000
					M6-M12		REDU-16/12-M	T3071161250-000
	PG16-M16				REDU-PG16-M16	T3071161601-000		
	M20-PG9				REDU-M20-PG9	T3071200900-000		
	M20-PG11				REDU-M20-PG11	T3071201101-000		
	M20-M12				REDU-20/12-M	T3071201250-000		
	M20-M16				REDU-20/16-M	T3071201650-000		
	PG21-PG16				REDU-21/16-PG	T3071211602-000		
	PG21-M25				REDU-PG21-M25	T3071212502-000		
	M25-M20				REDU-25/20-M	T3071252050-000		
	PG29-PG21				REDU-29/21-PG	T3071292101-000		
	PG29-M32				REDU-PG29-M32	T3071293202-000		
	M32-M25				REDU-32/25-M	T3071322550-000		
	PG36-PG29				REDU-36/29-PG	T3071362902-000		
	M40-M32				REDU-40/32-M	T3071403250-000		
	PG42-PG36				REDU-42/36-PG	T3071423601-000		
	M50-M40				REDU-50/40-M	T3071504050-000		
	PG9-PG7				REDU-9/7-PG	T3167090701-000		
	PG16-PG11				REDU-16/11-PG	T3167161101-000		
	PG21-PG9				REDU-21/9-PG	T3167210901-000		
	PG21-PG11				REDU-21/11-PG	T3167211101-000		
	PG21-PG13.5				REDU-21/13-PG	T3167211301-000		
	M32-PG21		REDU-32/21	T3167322111-000				
	M50-M32		REDU-50/32-M	T3167503211-000				
Product Image				Dimensions	Type	PN		
				14-Dec	BK14	T1918121400-000		
				14-18	BK18	T1918121800-000		
				18-22	BK22	T1922182200-000		
				22-26	BK26	T1926222600-000		
				26-32	BK32	T1932263200-000		
				30-34	BK34	T1934303400-000		
				24-28	BK38	T1938303800-000		
				28-42	BK42	T1942384200-000		
				42-50	BK50	T1950425000-000		
				46-54	BK54	T1954465400-000		
				60-64	BK64	T1964566400-000		
				64-70	BK70	T1970667000-000		
						10	AD10	T3310010000-000
						13	AD13	T3310013000-000
						15.8	AD15.8	T3310015000-000
				21.2	AD21.2	T3310022000-000		
				28.5	AD28.5	T3310028000-000		
				34.5	AD34.5	T3310034000-000		
				35	AD35	T3310035000-000		
				42.5	AD42.5	T3310040000-000		
				54.5	AD54.5	T3310054000-000		
				80	AD80	T3310079000-000		
		106	AD106	T3310105000-000				

Material: PA
 Temperature range:
 -40°C + 100°C

Inside and Outside Thread Adapter

Inside and outside thread adapter	Product Image	Metr.	PG	Type	PN	
Material: Nickel plated brass Temperature range: -40°C + 100°C		M16		STUD-16-M	T3265161611-000	
		M20		STUD-20-M	T3265202011-000	
		M25		STUD-M25-L	T3333252512-000	
				PG13.5	STUD-PG13.5	T3333131312-000
				PG16	STUD-PG16	T3333161612-000
				PG21	STUD-PG21	T3333212112-000
				PG29	STUD-PG29	T3333292912-000
				M20	STUD-M20	T3333202011-000
				M25	STUD-M25	T3333252511-000
				M32	STUD-M32	T3333323211-000
				M40	STUD-M40	T3333404011-000
				PG21	STUD-PG21	T3333212102-000
				M20	STUD-M20	T3333202001-000
				M25	STUD-M25	T3333252501-000
				M32	STUD-M32	T3333323201-000

te.com

© 2019 TE Connectivity. All Rights Reserved.

TE, TE Connectivity, and TE Connectivity (logo) are trademarks. All other logos, products and/or company names referred to herein might be trademarks of their respective owners.

While TE has made every reasonable effort to ensure the accuracy of the information in this brochure, TE does not guarantee that it is error-free, nor does TE make any other representation, warranty or guarantee that the information is accurate, correct, reliable or current. TE reserves the right to make any adjustments to the information contained herein at any time without notice. TE expressly disclaims all implied warranties regarding the information contained herein, including, but not limited to, any implied warranties of merchantability or fitness for a particular purpose. The dimensions in this catalog are for reference purposes only and are subject to change without notice. Specifications are subject to change without notice. Consult TE for the latest dimensions and design specifications.

1-1773869-8 SL 03/19