

BNC Connectors (50 ohm/75 ohm) Performance Specifications

Characteristics	Single Crimp (MIL Type)	Category B O Crimp (MIL Type)	Straight Solder Clamp	Right-Angle Solder Clamp	Commercial O Crimp & Hex Crimp 50 Ohms	Commercial O Crimp & Hex Crimp 75 Ohms	Commercial PC Board 50 & 75 Ohms	Commercial Solder 50 Ohm Jacks
Electrical								
Impedance, Nom. (Ohms)	50	50	50	50	50	75	50 & 75	50 & 75
Working Voltage (Volts RMS)	500	500	500	500	500	500	500	500
Contact Resistance (Milliohms)	Inner: 1.5 Outer: 0.3	Inner: 1.5 Outer: 0.2	Inner: 1.5 Outer: .20	Inner: 1.5 Outer: .20	Inner: 2.0 Outer: 1.0	Inner: 2.0 Outer: 2.0	Inner: 6/1.5 Outer: 3/0.2	Inner: 2.75 Outer: 1.0
Initial Insulation Resistance (Megohms)	5000	5000	5000	5000	5000	5000	5000	5000
Dielectric Withstanding Voltage (VAC)	1500	1500	1500	1500	1500	1500	1500	1500
Corona Level at 70,000 ft. (Volts, RMS)	375	375	375	375	375	375	—	375
RF Leakage, Max. (dB)	—	-55 at 2-3 GHz	-55 at 2-3 GHz	-55 at 2-3 GHz	-55 at 2-3 GHz	-55 at 1-2 GHz	—	—
RF Insertion Loss, Max. (dB)	—	0.2 at 3 GHz	0.2 at 3 GHz	0.3 at 3 GHz	0.2 at 3 GHz	0.15 at 2 GHz	—	—
Frequency Range (GHz)	0-2.5	0-4	0-4	0-4	0-4	0-2	0-4 and 0-2	0-4
VSWR in Frequency Range Max.	1.35	1.30	1.30	1.35	1.30	1.30	—	—
Mechanical								
Force to Engage (lbs. [N])/couple, (in-lbs. [N-m]) max.	13.3/11.12 [3/2.5]	13.3/11.12 [3/2.5]	13.3/.028 [3/2.5]	13.3/.028 [3/2.5]	26.7/26.69 [6/6.0]	26.7/26.69 [6/6.0]	—	—
Coupling Nut Retention, Min. N [lbs.]	444.8 [100]	444.8 [100]	444.8 [100]	444.8 [100]	266.9 [60]	266.9 [60]	—	—
Cable Retention, N [lbs.]	266.9 [60] (RG58C/U)	266.9 [60] (RG58C/U)	177.9 [40] (RG58C/U)	177.9 [40] (RG58C/U)	266.9 [60] (RG58C/U)	266.9 [60] (RG58C/U)	266.9 [60] (PCB Ret)	—
Durability (Cycles)	500	500	500	500	500	500	500	500
Jam Nut Mounting Torque, Max. [N•m] (in. lbs.)	25 [2.8]	25 [2.8]	25 [2.8]	—	25 [2.8]	25 [2.8]	25 ³ /12 ⁴ [2.8/1.4]	25 [2.8]
Environmental								
Temperature Range, Operating (C°)	-65 to +85	-65 to +165 ¹ -55 to +85 ²	-65 to +165	-65 to +165	-55 to +85	-55 to +85	-55 to +85	-65 to +165
Vibration	MIL-STD-202 Method 204 Cond. B	MIL-STD-202 Method 204 Cond. B	MIL-STD-202 Method 204 Cond. B	MIL-STD-202 Method 204 Cond. B	MIL-STD-1344 Method 2005 Cond. III	MIL-STD-202 Method 204 Cond. B	MIL-STD-202 Method 201A	MIL-STD-202 Method 204 Cond. B
Physical Shock	MIL-STD-202 Method 213 Cond. G, 50 G's	MIL-STD-202 Method 213 Cond. G, 50 G's	MIL-STD-202 Method 213 Cond. G	MIL-STD-202 Method 213 Cond. G	MIL-STD-1344 Method 2004 Cond. G, 100 G's	MIL-STD-202 Method 213 Cond. I, 100 G's	MIL-STD-202 Method 213 Cond. I or A, 50 G's	MIL-STD-202 Method 213 Cond. I, 100 G's
Thermal Shock	MIL-STD-202 Method 107	MIL-STD-202 Method 107	MIL-STD-202 Method 107	MIL-STD-202 Method 107	MIL-STD-1344 Method 1003 Cond. A	MIL-STD-202 Method 107	MIL-STD-202 Method 107	MIL-STD-202 Method 107
Moisture Resistance	MIL-STD-202 Method 106	MIL-STD-202 Method 106	MIL-STD-202 Method 106	MIL-STD-202 Method 106	MIL-STD-1344 Method 1002 Type II	MIL-STD-202 Method 106	MIL-STD-202 Method 106	MIL-STD-202 Method 106
Salt Spray	MIL-STD-202 Method 101 Cond. B	MIL-STD-202 Method 101 Cond. B	MIL-STD-202 Method 101 Cond. B	MIL-STD-202 Method 101 Cond. B	MIL-STD-1344 Method 1001 Cond. B	MIL-STD-202 Method 101 Cond. B	MIL-STD-202 Method 101 Cond. B	MIL-STD-202 Method 101 Cond. B
Product Specification	108-12002	108-12020	—	—	108-12044 108-12047	108-12095	108-12078	108-12079

¹Assembled to cable with polytetrafluorethylene dielectric.

²Assembled to cable with polyethylene dielectric.

³For Metal Threads

⁴For Polyester Threads

BNC Connectors, 50 Ohm (Continued)

Insulating Bushings



Part No. 227223-1



Recommended Panel Cutout



Part No. 221951-1



Recommended Panel Cutout

Isolated Bulkhead Solder Jacks, Front Mount

Plating

Body — Nickel

Dielectric — White VALOX

Center Contact Plating	Flange & Thread Material	Part No.
Tin	VALOX	5227726-1
Silver	VALOX	5227726-2
Gold	VALOX	5227726-3



Recommended Panel Cutout

Plating

Body — Nickel

Center Contact — Silver

Dielectric — Black VALOX

Flange & Thread Material — Black VALOX



Part No. 5414194-1



Recommended Panel Cutout

Sealed Bulkhead Solder Jack, Rear Mount

Plating

Body — Nickel

Center Contact — Gold

Dielectric — Polymethylpentene

This connector is designed to prevent moisture from entering the interface from the rear of the connector.



Part No. 5227426-1



Recommended Panel Cutout

Note: Part Numbers are RoHS compliant except: ♦ Indicates non-RoHS compliant.

VALOX is a trademark of General Electric Company.

BNC Connectors, 50 Ohm (Continued)

**Right-Angle Jacks
PC Board/Panel Mount**

Body — Nickel
Dielectric — Polymethylpentene

VALOX Body



Metal Body



Mounting Post Style



Compliant Post



Maximum Panel Thickness 6.1 [240]

Recommended Panel Cutout

Lockwasher and Jam Nut



Part No.
1-329632-2

Part No.
1-329631-2

Without Mounting Posts



With Mounting Posts



Recommended PC Board Layouts

Body Material	Center Contact Plating	Dimensions			Part No.				
		A	B	C	Without Mounting Posts	With Mounting Posts	L	With Compliant Posts	L
VALOX, White	Tin	8.59 .338	21.21 .835	15.88 .625	5226990-1	5227161-1	3.48 .137	—	—
	Gold1	8.59 .338	21.21 .835	15.88 .625	5226990-3	5227161-3	3.48 .137	—	—
	Gold1	6.91 .272	21.21 .835	13.18 .519	—	5227161-7	3.48 .137	—	—
VALOX, Black	Tin	8.59 .338	21.21 .835	15.88 .625	—	5227161-2	3.48 .137	—	—
	Gold1	8.59 .338	21.21 .835	15.88 .625	5226990-6	5227161-6	3.48 .137	—	—
	Gold1	6.91 .272	21.21 .835	13.18 .519	—	5227161-9	3.48 .137	—	—
Metal	Gold1	6.17 .243	21.21 .835	11.68 .460	—	5415046-1	—	—	—
	Tin	8.26 .325	20.83 .820	15.88 .625	—	5227661-1	3.48 .137	—	—
	Gold1	8.26 .325	20.83 .820	15.88 .625	5227676-1	5227677-1	3.48 .137	—	—
	Gold1	6.91 .272	20.83 .820	12.70 .500	1274668-1	5413879-1	3.48 .137	—	—
High Temp. Housing	Gold2	6.91 .272	20.83 .820	12.70 .500	—	5413879-2	3.48 .137	—	—
	Gold1	6.91 .272	21.21 .835	13.18 .519	—	—	—	5415218-5	2.79 .110

Plating:

Gold1 — 0.00076 [0.000030] thick

Gold2 — 0.00127 [0.000050] thick

Note: If an Insulating Bushing is required see part number 330620 and Panel Cutout on page 54.

VALOX is a trademark of General Electric Company.

Note: Part Numbers are RoHS compliant except: ♦ Indicates non-RoHS compliant.

BNC Connectors, 50 Ohm (Continued)

**Vertical Jacks
PC Board/Panel Mount**

Plating
Body — Nickel
Dielectric — Polymethylpentene



Maximum Panel Thickness 6.1 [.240]

Recommended Panel Cutout

Lockwasher and Jam Nut



Part No.
1-329632-2

Part No.
1-329631-2

VALOX Body



Metal Body



Body Material	Center Contact Plating	Dim. B	Dim. L	Part No.	
				Without Mounting Posts	With Mounting Posts
VALOX, White	Tin	21.21 .835	3.48 .137	5226993-1	5227222-1
	Gold	21.21 .835	3.48 .137	5226993-3	5227222-3
VALOX, Black	Tin	21.21 .835	3.48 .137	5226993-2	5227222-2
	Gold	21.21 .835	3.48 .137	5226993-6	5227222-6
Metal	Tin	20.83 .820	3.48 .137	—	5227671-1
	Gold	20.83 .820	3.48 .137	—	5227673-1

Note: If an Insulating Bushing is required see part number 330620 and Panel Cutout on page 54.

Without Mounting Posts



With Mounting Posts



Recommended PC Board Layouts

* Screw for board thickness of 2.38 [.093] or greater **Part No. 221108-2**.
Screw for thickness of less than 2.38 [.093] **Part No. 221108-4**.

VALOX is a trademark of General Electric Company.

Note: Part Numbers are RoHS compliant except: ♦ Indicates non-RoHS compliant.

BNC Connectors, 50 Ohm (Continued)

**Jacks with
Mounting Flanges
PC Board/Panel Mount**



Maximum Panel Thickness 6.1 [.240]

Recommended Panel Cutout



Body Material	Center Contact Plating	Part No.
VALOX, White	Tin	5226978-1
	Gold	5226978-3

Lockwasher and Jam Nut



Part No.
1-329632-2



Part No.
1-329631-2



Recommended PC Board Layout

VALOX is a trademark of General Electric Company.

Note: Part Numbers are RoHS compliant except: ♦ Indicates non-RoHS compliant.

BNC Connectors, 50 Ohm (Continued)

**Vertical Metalized Jacks,
PC Board Mount**



**Part No. 1274314-1
(Switching)**



**Recommended
PC Board Layout**



Part No. 1274315-1



**Recommended
PC Board Layout**

Body Plating	Contact Plating	Dielectric	Part No.
Tin	Silver	Polyphenylene	6274314-1
Tin	Silver	Polyphenylene	6274315-1

**Press Fit Vertical Metalized Jack,
PC Board Mount**



Part No. 5222006-1



Recommended PC Board Layout
PC Board Thickness Not Less Than 0.99 [0.093]

Insulating Bushing

Material — Polypropylene
Part No. 222163-1

Only to be used on Part Nos. 5222006-1 & 5222462-1



Note: Part Numbers are RoHS compliant except: ♦ Indicates non-RoHS compliant.

BNC Connectors, 50 Ohm (Continued)

Jack-Jack Adapters

Style A



Style B

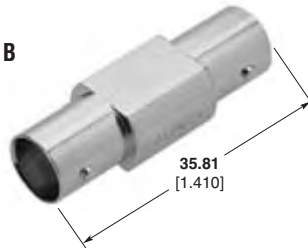

Body Plating	Center Contact Plating	Dielectric	Style	Part No.
Nickel	Silver		A	221551-1
Nickel	Gold		A	221551-3
Nickel	Gold	Polymethyl-pentene	B	5414414-1

Bulkhead Jack-Jack Adapters

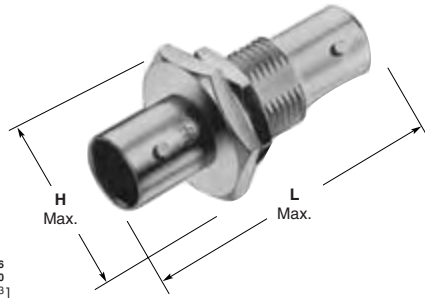
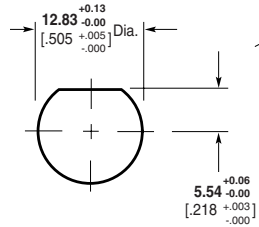

Body Plating	Center Contact Plating	Dimensions		Dielectric	Part No.
		H	L		
Nickel	Silver	17.45 .687	38.10 1.500		330024
Nickel	Gold1	17.78 .700	36.07 1.420	Poly-ethylene	5228226-1
Nickel	Gold2	17.78 .700	36.07 1.420	Poly-ethylene	5228226-3

Plating:

Gold1—0.00127 [.000050] thick Gold2—0.00076 [.000015] thick

Note: If an Insulating Bushing is required see part number 330620 and Panel Cutout on page 54.

Recommended Panel Cutout

H= 11/16 across flats, 20.32 [.800] across points.

Isolated Bulkhead Jack-Jack Adapter

Body Plating	Center Contact Plating	Dielectric	Part No.
Nickel	Gold	Polymethylpentene	5414105-1

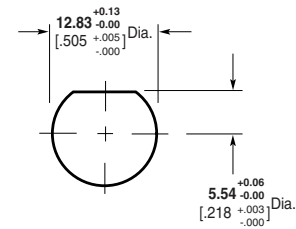
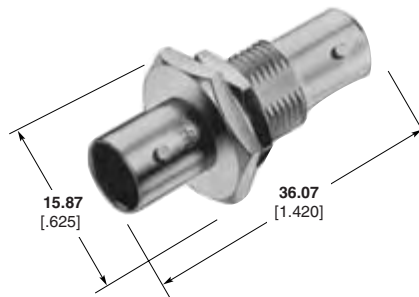

Recommended Panel Cutout

H= 11/16 across flats, 20.32 [.800] across points.

Plug-Plug Adapter



Contact Plating	Body Plating	Part No.
Gold	Nickel	415796-1

Right-Angle Adapters

(Jack-Plug)

Body Plating	Center Contact Plating	Dielectric	Part No.
Nickel	Silver		5329517
Nickel	Gold		5222165-2
Nickel	Gold	Polymethylpentene	5414666-1

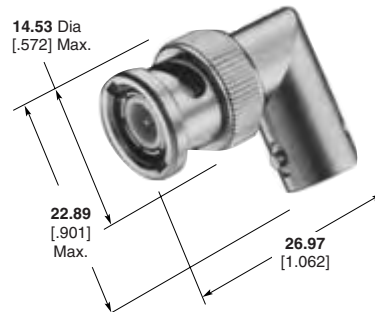

Note: Part Numbers are RoHS compliant except: ♦ Indicates non-RoHS compliant.

BNC Connectors, 50 Ohm (Continued)

**Terminator Plugs
50, 75, 93 Ohm**

Plating

Body—Nickel
Center Contact—Gold
Dielectric—Polyethylene



Resistor Specification	Part No.	
	With Tether	Without Tether
1 Watt, 50 Ohm	5221629-1	5221629-4
1 Watt, 75 Ohm	5221629-2	5221629-5
1 Watt, 93 Ohm	—	5221629-6
0.5 Watt, 75 Ohm	—	—
1 Watt, 50 Ohm	1-5221629-6 ¹	—

¹ Tether is conductive with #4 stud size

Insulated Terminators

Insulation Material
Polyphenylene oxide

Long Cover



Register Specification	Color	Cover Style	Part No.
1 Watt, 50 Ohm	Gray	Long	5413557-1
		Short	5413364-2
	Black	Long	5413557-2

* The Short Cover is required when mating the Terminator with a Tee Adapter.

Jack Covers

Body Plating	Part No.
Silver	330022
Nickel	1-330022-2



Shorting Caps

Plating

Body—Nickel
Center Contact—Gold



Part No. 413453-1

Note: Part Numbers are RoHS compliant except: ♦ Indicates non-RoHS compliant.

BNC Connectors, 75 Ohm

Plugs, Crimp

These connectors have been designed for optimum performance and have a true 75 ohm impedance the complete length of the connector. The crimp die tooling listed below is different from the equivalent 50 ohm connectors.



Plugs

RG/U Cable	Termination Type	Center Contact Plating	Body Plating	Dielectric	Style	Dim. L	Interchangeable Dies for PRO-CRIMPER Hand Tool 354940-1 or PRO-CRIMPER Adapter 679304-1	Interchangeable Dies for Hand Tool 69710-1 & 626 Pneu. Head 318161-1	Part No.
179, 179A, 179B, 187, 187A, 161, BELDEN 9221	Hex Crimp	Gold	Nickel	Polyethelene	Commercial	29.46 1.160	58425-2	—	5413589-8
	O Crimp	Gold	Nickel	Polyethelene	Commercial	35.56 1.140	318451-2	—	5221185-8
AT&T 735A	Hex Crimp	Gold	Nickel	Polyethelene	Commercial	29.46 1.160	58425-2	—	1-5413589-0
	O Crimp	Gold	Nickel	Polyethelene	Commercial	27.69 1.090	58174-1	58248-3	1-5221185-8
BELDEN 8218	Hex Crimp	Gold	Nickel	Polyethelene	Commercial	29.46 1.160	58425-2	—	5413589-3
	O Crimp	Gold	Nickel	Polyethelene	Commercial	27.69 1.090	58174-1	58248-3	5221185-3
140, 210, 62, 62A, 62B, 59, 59A, 59B, BELDEN 9291, 9209, 9269	Hex Crimp	Gold	Nickel	Polyethelene	Commercial	29.46 1.160	58425-1	—	5413589-2
	O Crimp	Gold	Nickel	Polyethelene	Commercial	27.69 1.090	58536-1	58248-2	5221185-2
302, BELDEN 89269, 88241, Hi-Temp 62A, Times PL-62, Berk Tek BTDC-59, BTDC-62	Hex Crimp	Gold	Nickel	Polyethelene	Commercial	29.46 1.160	58425-1	—	5413589-1
	O Crimp	Gold	Nickel	Polyethelene	Commercial	27.69 1.090	58536-1	58248-2	5221185-9
BELDEN 8212, 9104, 9112, 9167, 9240, 9259, 9266, Times FM-59, (RG 59 Type with 20 AWG C.C.)	Hex Crimp	Gold	Nickel	Polyethelene	Commercial	29.46 1.160	58425-1	—	5413589-7
	O Crimp	Gold	Nickel	Polyethelene	Commercial	27.69 1.090	58536-1	—	1-5221185-0
BELDEN 9145, AT&T 734A	Hex Crimp	Gold	Nickel	Polyethelene	Commercial	29.46 1.160	58425-1	—	5413589-7
	O Crimp	Gold	Nickel	Polyethelene	Commercial	27.69 1.090	58536-1	—	1-5221185-0
BELDEN 9248, 9114	O Crimp	Gold	Nickel	Polyethelene	Commercial	25.65 1.010	58536-1	—	5221185-1
6, 6A	O Crimp	Gold	Nickel	Polyethelene	Commercial	37.85 1.490	58538-1	58248-1	5221185-7
BELDEN 8281, 9141, 9231, Western Electric 724, 728, 3049	Hex Crimp	Gold	Nickel	Polyethelene	Commercial	29.46 1.160	58425-3	—	5413589-5
	O Crimp	Gold	Nickel	Polyethelene	Commercial	28.45 1.120	58538-1	58248-1	5221185-5
COMM/SCOPE S59 Hec	O Crimp	Gold	Nickel	Polyethelene	Commercial	28.96 1.140	58536-1	—	2-5221185-9
COMM/SCOPE F59 Hec-z	O Crimp	Gold	Nickel	Polyethelene	Commercial	28.96 1.140	58536-1	—	3-5221185-1

AT&T is a trademark of AT&T Corporation.
 BELDEN is a trademark of Belden Wire and Cable Company.
 COMM/SCOPE is a trademark of Commscope, Inc.

Note: Part Numbers are RoHS compliant except: ♦ Indicates non-RoHS compliant.

BNC Connectors, 75 Ohm (Continued)

Plugs for JIS Cables, Crimp

Plating

Body — Nickel
Center Contact — Gold



JIS Cable	Termination Type	Dielectric	Dim. L	Interchangeable Dies for PRO-CRIMPER Hand Tool 354940-1 or PRO-CRIMPER Adapter 679304-1	Part No.
3C-2V	Hex Crimp	Polymethylpentene	29.46 1.160	58425-1	1-5413589-1
2.5C-2V	Hex Crimp	Polymethylpentene	29.46 1.160	58425-2	1-5413589-6

Bulkhead Jacks for JIS Cables, Crimp

Plating

Body — Nickel
Center Contact — Gold
Dielectric — Polymethylpentene

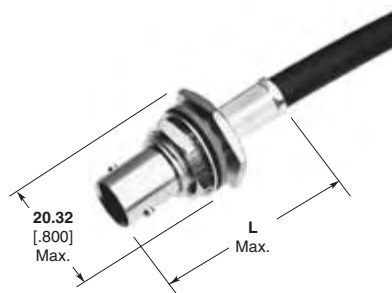

JIS Cable	Termination Type	Dielectric	Dim. L	Interchangeable Dies for PRO-CRIMPER Hand Tool 354940-1 or PRO-CRIMPER Adapter 679304-1	Part No.
1.5C-2V	Hex Crimp	75Ω	36.83 1.450	58425-2	5413590-4*

*Packaged in 100 pieces per bag.

Note: Part Numbers are RoHS compliant except: ♦ Indicates non-RoHS compliant.

BNC Connectors, 75 Ohm (Continued)

Right-Angle Plugs, Crimp



RG/U Cable	Termination Type	Center Contact Plating	Body Plating	Dielectric	Style	Dim. L	Interchangeable Dies for PRO-CRIMPER Hand Tool 354940-1 or PRO-CRIMPER Adapter 679304-1	Interchangeable Dies for Hand Tool 69710-1 & 626 Pneu. Head 318161-1	Part No.
179, 179A, 179B, 187, 187A, 161 BELDEN 9221	Hex Crimp	Gold	Nickel	Polymethyl-pentene	Commercial	39.45 1.553	58425-2	—	5413588-8
AT&T 735A	Hex Crimp	Gold	Nickel	Polymethyl-pentene	Commercial	39.45 1.553	58425-2	—	1-5413588-0
AT&T KS 19224 L2, RD179 Double Braid	Hex Crimp	Gold	Nickel	Polymethyl-pentene	Commercial	39.45 1.553	58425-2	—	5413588-4
140, 210, 62, 62A, 62B, 59, 59A, 59B, BELDEN 9291, 9209, 9269	Hex Crimp	Gold	Nickel	Polymethyl-pentene	Commercial	39.45 1.553	58425-1	—	5413588-2
	O Crimp	Gold	Nickel	Polymethyl-pentene	Commercial	39.88 1.570	58536-1	58248-2	5221402-2
BELDEN 8212, 9104, 9112, 9240, 9167, 9259, 9266, Times FM-59, (RG 59 Type with 20 AWG C.C.)	Hex Crimp	Gold	Nickel	Polymethyl-pentene	Commercial	39.45 1.553	58425-1	—	5413588-9
BELDEN 9145, AT&T 734A	O Crimp	Gold	Nickel	Polymethyl-pentene	Commercial	39.88 1.570	58536-1	—	5221402-4

AT&T is a trademark of AT&T Corporation.
BELDEN is a trademark of Belden Wire and Cable Company.

Note: Part Numbers are RoHS compliant except: ♦ Indicates non-RoHS compliant.

BNC Connectors, 75 Ohm (Continued)

Jacks, Crimp

Hex and O Crimp



RG/U Cable	Termination Type	Center Contact Plating	Body Plating	Dielectric	Style	Dim. L	Interchangeable Dies for PRO-CRIMPER Hand Tool 354940-1 or PRO-CRIMPER Adapter 679304-1	Interchangeable Dies for Hand Tool 69710-1 & 626 Pneu. Head 318161-1	Part No.
179, 179A, 179B, 161, 187, 187A, BELDEN 9221	Hex Crimp	Gold	Nickel	Polyethelene	Commercial	33.02 1.300	58425-2	—	5413760-8
	O Crimp	Gold	Nickel	Polyethelene	Commercial	30.48 1.200	318451-2	—	5221199-5
BELDEN 8218	Hex Crimp	Gold	Nickel	Polyethelene	Commercial	33.02 1.300	58425-2	—	5413760-3
140, 210, 62, 62A, 62B, 59, 59A, 59B, BELDEN 9291, 9209, 9269	O Crimp	Gold	Nickel	Polyethelene	Commercial	30.48 1.200	58536-1	58248-2	5221199-2
302, BELDEN 88241, 89269, Hi-Temp 62A, Times PL-62, Berk Tek BTDC-59, BTDC-62	Hex Crimp	Gold	Nickel	Polyethelene	Commercial	33.02 1.300	58425-1	—	5413760-1
BELDEN 8212, 9104, 9112, 9240, 9167, 9259, 9266, Times FM-59, (RG 59 Type with 20 AWG C.C.)	Hex Crimp	Gold	Nickel	Polyethelene	Commercial	33.02 1.300	58425-1	—	5413760-9
BELDEN 9248, 9114	O Crimp	Gold	Nickel	Polyethelene	Commercial	30.48 1.200	58536-1	—	5221199-1

BELDEN is a trademark of Belden Wire and Cable Company.

Note: Part Numbers are RoHS compliant except: ♦ Indicates non-RoHS compliant.

BNC Connectors, 75 Ohm (Continued)

Bulkhead Jacks, Crimp

Hex and O Crimp

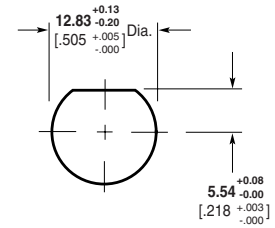

Maximum Panel Thickness 6.1 [0.240]

Recommended Panel Cutout

RG/U Cable	Termination Type	Center Contact Plating	Body Plating	Dielectric	Style	Dim. L	Interchangeable Dies for PRO-CRIMPER Hand Tool 354940-1 or PRO-CRIMPER Adapter 679304-1	Interchangeable Dies for Hand Tool 69710-1 & 626 Pneu. Head 318161-1	Part No.
179, 179A, 179B, 161, 187, 187A, BELDEN 9221	Hex Crimp	Gold	Nickel	Polyethelene	Commercial	36.83 1.450	58425-2	—	5413590-8
	O Crimp	Gold	Nickel	Polyethelene	Commercial	34.93 1.375	318451-2	—	5221221-5
AT&T KS 19224 L2, RD179 Double Braid	Hex Crimp	Gold	Nickel	Polyethelene	Commercial	36.83 1.450	58425-2	—	5413590-4
BELDEN 8218	Hex Crimp	Gold	Nickel	Polyethelene	Commercial	36.83 1.450	58425-2	—	5413590-3
140, 210, 62, 62A, 62B, 59, 59A, 59B, BELDEN 9291, 9209, 9269	O Crimp	Gold	Nickel	Polyethelene	Commercial	34.93 1.375	58536-1	58248-2	5221221-2
BELDEN 8212, 9104, 9112, 9240, 9167, 9259, 9266, Times FM-59 (RG 59 Type with 20 AWG C.C.)	O Crimp	Gold	Nickel	Polyethelene	Commercial	34.93 1.375	58536-1	58248-2	5221221-7
BELDEN 9114, 9248	O Crimp	Gold	Nickel	Polyethelene	Commercial	34.93 1.375	58536-1	—	5221221-1

AT&T is a trademark of AT&T Corporation.
BELDEN is a trademark of Belden Wire and Cable Company.

Note: Part Numbers are RoHS compliant except: ♦ Indicates non-RoHS compliant.

BNC Connectors, 75 Ohm (Continued)

**Bulkhead Solder Jacks
Front Mount**

Plating

Body — Nickel

Center Contact — Silver



Maximum Panel Thickness **3.18** [.125]

Recommended Panel Cutout



Note: If insulating bushing required use part no. 227223-1 or 221951-1 (for details, reference page 55).



Note: If insulating bushing required use part no. 227223-1 or 221951-1 (for details, reference page 55).

**Bulkhead Jack
PC Board Mount**



**Bulkhead Solder Jack
Rear Mount**

Lockwasher and Jam Nut see page 73.

Plating

Body — Nickel

Center Contact — Gold

Dielectric — Polymethylpentene

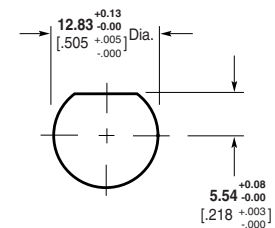

Maximum Panel Thickness **6.35** [.250]

Recommended Panel Cutout

Note: Part Numbers are RoHS compliant except: ♦ Indicates non-RoHS compliant.

BNC Connectors, 75 Ohm (Continued)

**Right-Angle Jacks
PC Board/Panel Mount**

Outer Shell — Nickel
Dielectric — Polymethylpentene
Lockwasher and Jam Nut see page 73.

VALOX Body



Metal Body



Maximum Panel Thickness **6.1** [240]

Recommended Panel Cutout



Recommended PC Board Layouts

Without Mounting Posts



With Mounting Posts



* Screw for panel thickness of **2.38** [3/32] or greater
Part No. 221108-2.
Screw for panel thickness of less than **2.38** [3/32]
Part No. 221108-4.

Body Material	Center Contact Plating	Dimensions				Part No.	
		A	B	C	L	Without Mounting Posts	With Mounting Posts
VALOX, Black w/ Compliant Posts (Economy)*	Gold3	6.17 .243	21.21 .835	11.68 .460	2.79 .110	—	5415105-2
VALOX, Black (Economy)*	Gold3	6.17 .243	21.21 .835	11.68 .460	4.01 .158	—	5415105-1
VALOX, White	Gold1	6.91 .272	21.21 .835	13.88 .519	3.48 .137	—	5413194-1
VALOX, White (Economy)*	Gold1	6.91 .272	21.21 .835	13.88 .519	3.48 .137	—	5415634-2
VALOX, Black	Gold1	6.91 .272	21.21 .835	13.88 .519	3.48 .137	—	5413194-2
VALOX, Black (Economy)*	Gold1	6.91 .272	21.21 .835	13.88 .519	3.48 .137	—	5415634-1
VALOX, Black (Economy)*	Gold1	8.59 .338	21.21 .835	15.88 .625	3.48 .137	—	5415633-1
VALOX, White	Gold2	8.59 .338	21.21 .835	15.88 .625	3.48 .137	—	5414459-1
Metal	Gold1	8.25 .325	20.83 .820	15.88 .625	2.16 .085	—	5222092-1
Metal	Gold1	8.25 .325	20.83 .820	15.88 .625	—	5222093-1	—
Metal (Economy)*	Gold1	8.25 .325	20.83 .820	15.88 .625	3.48 .137	—	5414409-1
Metal with Compliant Posts (Economy)*	Gold1	6.91 .272	20.83 .820	12.70 .500	3.48 .137	—	5415417-1
Metal with Compliant Posts (Economy)*	Tin	8.56 .337	21.21 .835	15.88 .625	3.48 .137	—	5415419-1
Metal	Gold1	8.25 .325	20.83 .820	15.88 .625	3.48 .137	—	5222092-3
Metal	Gold1	6.91 .272	20.83 .820	12.70 .500	3.48 .137	—	5414907-1
Metal	Gold1	6.91 .272	20.83 .820	12.70 .500	—	6274072-1	—
Metal (Economy)*	Gold1	6.91 .272	20.83 .820	12.70 .500	3.48 .137	—	6274084-1

*Economy connector uses 50 Ω part with smaller dielectric and stamped and formed contact, Phosphor Bronze contact material (Compare to regular connector which is 75 Ω, screw machined Beryllium Copper).

Plating:

Gold1 — 0.00076 [0.00030] thick
Gold2 — 0.00127 [0.00050] thick

Note: If an Insulating Bushing is required see part number 330620 and Panel Cutout on page 54.

VALOX is a trademark of General Electric Company.

Note: Part Numbers are RoHS compliant except: ♦ Indicates non-RoHS compliant.

BNC Connectors, 75 Ohm (Continued)

**Vertical Jacks
PC Board/Panel Mount**

Plating

Outer Shell — Nickel

Dielectric — Polymethylpentene

VALOX Body



Metal Body



Maximum Panel Thickness 6.1 [.240]

Recommended Panel Cutout

Body Material	Contact Plating	Dim. B	Dim. L	Part No.
VALOX, Black (Economy)*	Gold1	21.21 .835	3.48 .137	5415632-1
VALOX, White (Economy)*	Gold1	21.21 .835	3.48 .137	5415632-2
Metal	Gold1	20.83 .820	3.48 .137	5222132-1
Metal (Economy)*	Tin	21.21 .835	3.48 .137	5415520-1

*Economy connector uses 50 Ω part with smaller dielectric and stamped and formed contact, Phosphor Bronze contact material (Compare to regular connector which is 75 Ω, screw machined Beryllium Copper).

Plating:

Gold1 — 0.00076 [.000030] thick

Note: If an Insulating Bushing is required see part number 330620 and Panel Cutout on page 54.

Lockwasher and Jam Nut



Part No.
1-329632-2



Part No.
1-329631-2

* Screw for panel thickness of 2.38 [3/32] or greater

Part No. 221108-2.

Screw for panel thickness of less than 2.38 [3/32]

Part No. 221108-4.

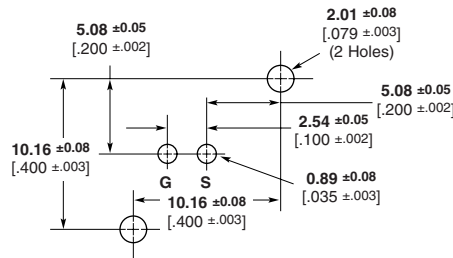

(Top View)

Recommended PC Board Layout

VALOX is a trademark of General Electric Company.

Note: Part Numbers are RoHS compliant except: ♦ Indicates non-RoHS compliant.

BNC Connectors, 75 Ohm (Continued)

**Vertical Metalized Jacks
PC Board Mount**

Plating
Dielectric — PTFE

Style A

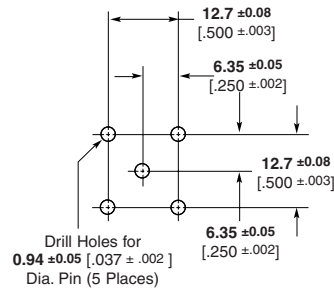

Style B

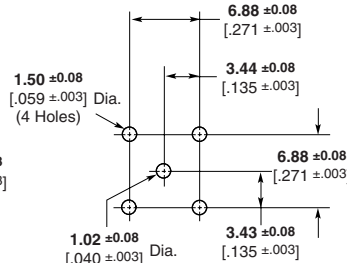

Style C

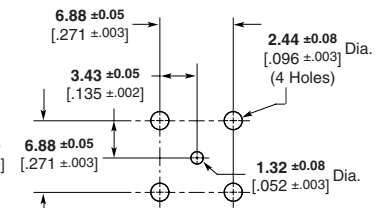
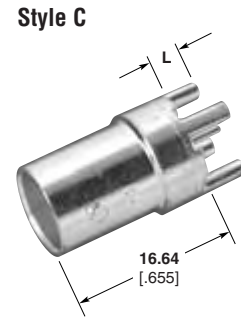

Recommended PC Board Layout

Style F (Push-On)

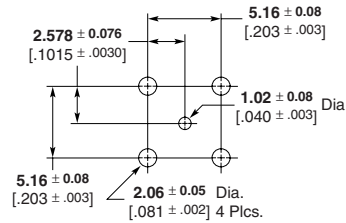

Body Plating	Center Contact Plating	Style	Leg Length L	Part No.
Nickel	Gold	B	3.30 .130	6274291-2
Tin	Gold	B	3.30 .130	6274291-1
Tin	Gold	B	6.35 .250	6274359-1
Tin	Gold	C	4.44 .175	5414394-1
Nickel	Silver	A	6.35 .250	5413986-1
Tin	Gold	F	2.54 .100	6274360-1

**Press Fit
Vertical Metalized Jacks
PC Board Mount**

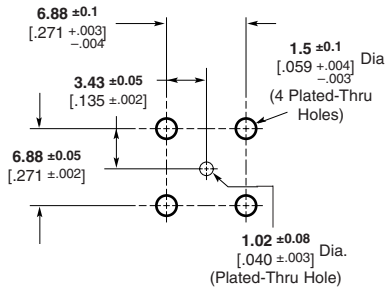
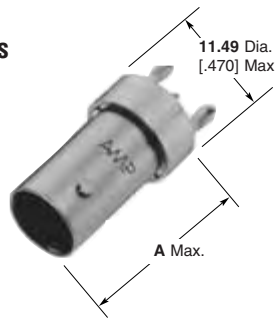

Recommended PC Board Layout

Dim. A	Part No.
20.57 .810	5222462-1
16.26 .640	5414088-1

Insulating Bushing

Material — Nylon
Part No. 222163-1
Only to be used on Part Nos.
5222462-1 and 5222006-1

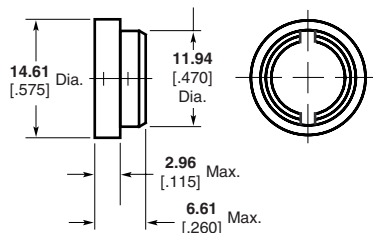

Note: Part Numbers are RoHS compliant except: ♦ Indicates non-RoHS compliant.

BNC Connectors, 75 Ohm (Continued)

Press Fit Vertical Metalized Jacks PC Board Mount
(Continued)

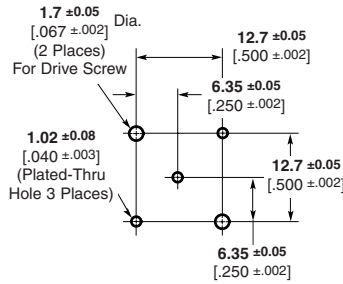
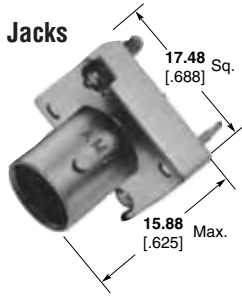

Recommended PC Board Layout

PC Board Thickness (Min.)	Part No.
2.36 .093	5221336-3
3.17 .125	5221336-4

Press Fit, Bulkhead Vertical Metalized Jack includes hardware

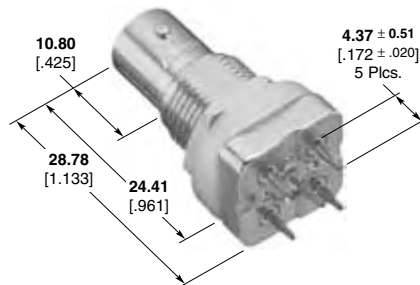

Part No. 6274124-2

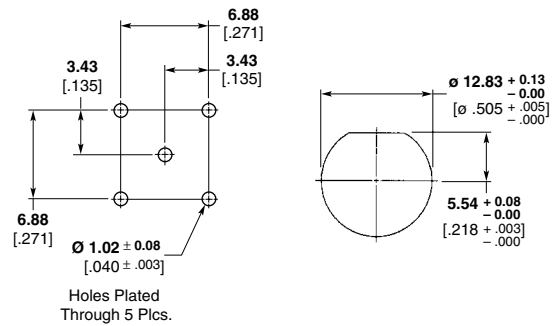

Recommended PC Board Layout

Right-Angle Metalized Jacks PC Board Mount

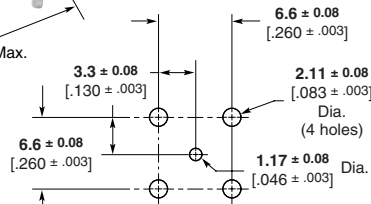

Maximum PC Board Thickness 2.54 [.100]

Recommended PC Board Layout

Body Plating	Dielectric	Contact Plating	Center Contact Dimension	Part No.
Nickel	TPX	Gold2	.171 [.007]	5413558-1
Tin	PTFE	Gold2	.171 [.007]	5413558-2
Nickel	TPX	Gold2	.131 [.005]	5413558-3
Nickel	TPX	Gold1	.171 [.007]	5413558-5

Gold1—0.00076 [.000030] thick
Gold2—0.00127 [.000050] thick

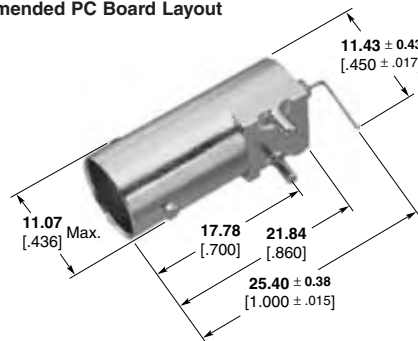

Part No. 6274127-1

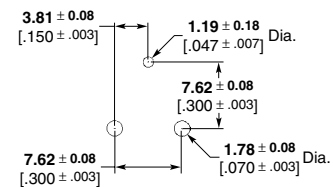

TPX is a trademark of Mitsui Chemicals America, Inc.

Note: Part Numbers are RoHS compliant except: ♦ Indicates non-RoHS compliant.

BNC Connectors, 75 Ohm (Continued)

**Right-Angle Metalized Jacks
PC Board/Panel Mount**

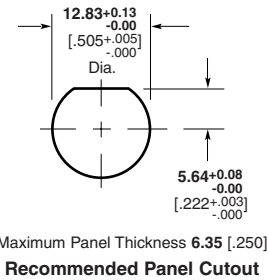
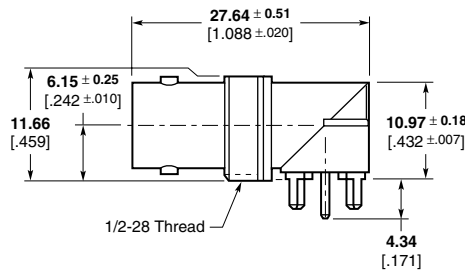

Body Plating	Dielectric	Part No.
Tin	PTFE	6274425-2

Bulkhead Jack-Jack Adapter

Plating

Body — Nickel
Center Contact — Gold
Dielectric — Polymethylpentene

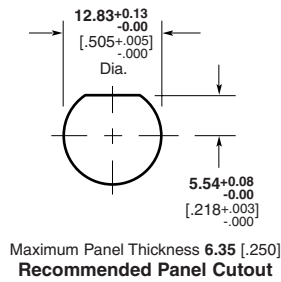
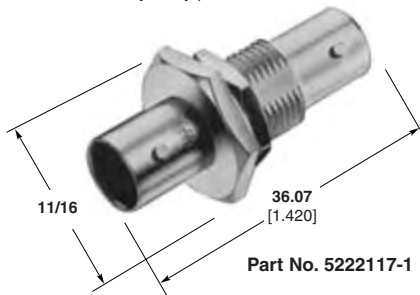

**Right-Angle Adapter
(Jack-Plug)**

Plating

Body — Nickel
Center Contact — Gold
Dielectric — Polymethylpentene

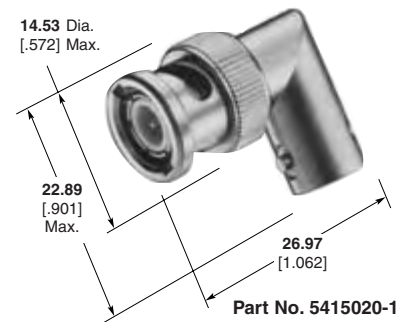

Bulkhead Jack-Jack Adapter

Plating

Body — Nickel
Center Contact — Gold
Dielectric — Polymethylpentene

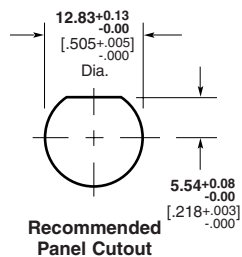
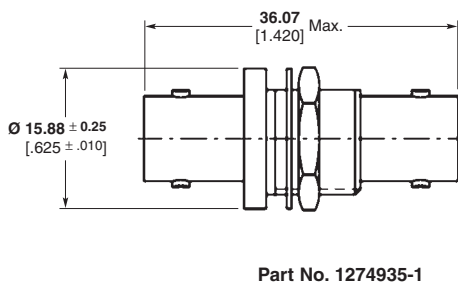

Jack-Jack Adapter

Plating

Body — Nickel
Center Contact — Gold
Dielectric — Polymethylpentene



Note: Part Numbers are RoHS compliant except: ♦ Indicates non-RoHS compliant.

BNC Connectors, 75 Ohm (Continued)

Bulkhead Jack-Push On Plug Adapter



Part No. 1274007-1



Recommended Panel Cutout

Note: Part Numbers are RoHS compliant except: ♦ Indicates non-RoHS compliant.