

Power Contacts x 6
Part Numbers

- 6650383-1 Press-fit tail, non-hot plug
- 6650383-2 Long solder tail, non-hot plug
- 6650383-3 Short solder tail, non-hot plug
- 6650384-1 Short solder tail, hot plug
- 6650384-2 Press-fit tail, hot plug
- 6650384-3 Long solder tail, hot plug

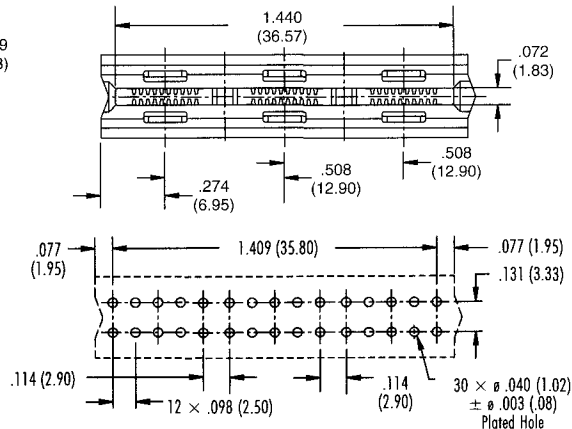
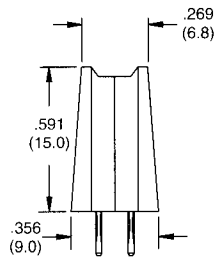
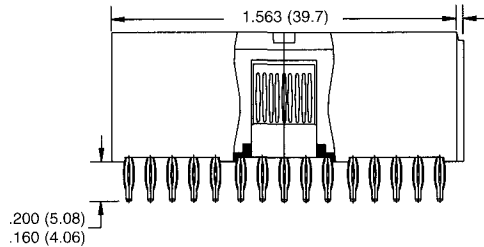

Signal Contacts x 24
Part Numbers

- 6650494-1 Press-fit tail
- 6651193-1 Long solder tail
- 6651214-1 Short solder tail

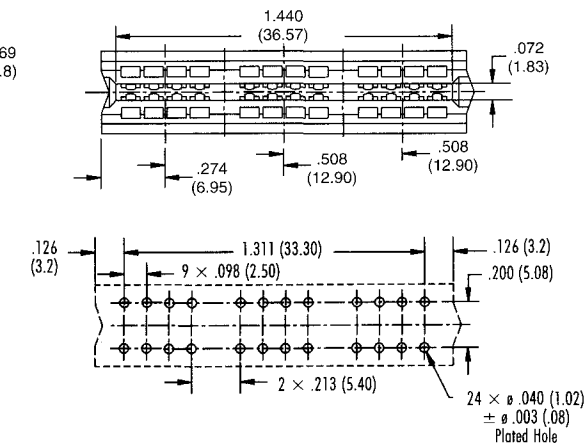
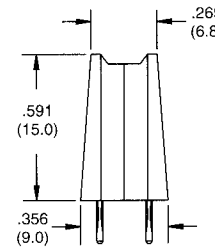
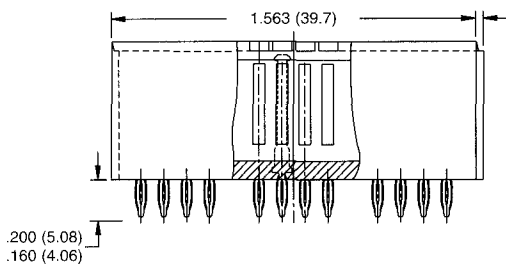

4 Power + 8 Signal Contacts
Part Numbers

- 6651290-1 Press-fit tail
- 6651290-2 Long solder tail
- 6651290-3 Short solder tail

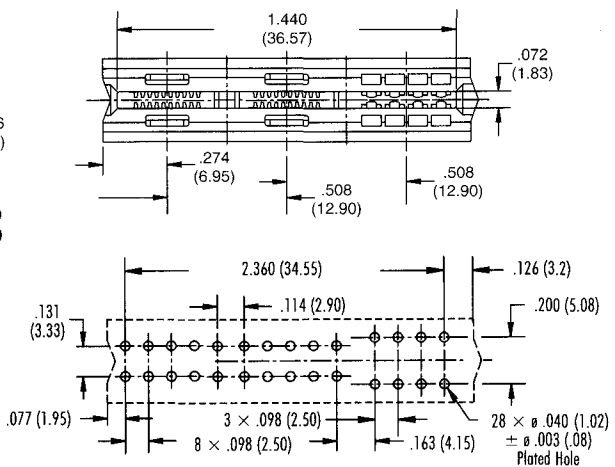
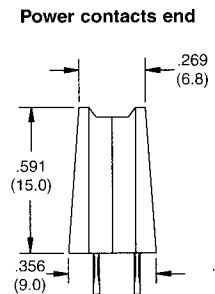
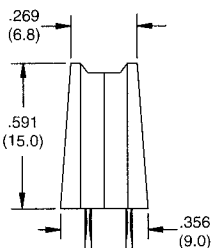
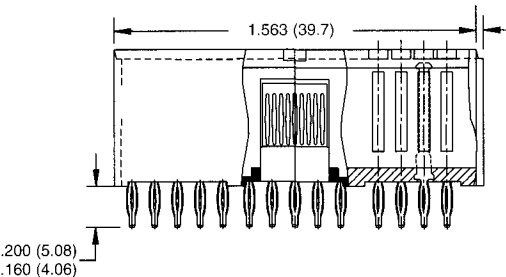

Card Edge Products