

Distributed by:

JAMECO[®]
ELECTRONICS

www.Jameco.com ♦ 1-800-831-4242

The content and copyrights of the attached
material are the property of its owner.

Jameco Part Number 861311

LOC	DIST	P	F	ZONE	LTR	DESCRIPTION	DATE	APPD
FT	38				C	REDRAWN WITHOUT CHANGE	09-14-93	-
					D	REV PER EC 0020-186-96	28 JUN 96	JCS
					E	REV PER EC 0320-385-97	19 NOV 97	DK

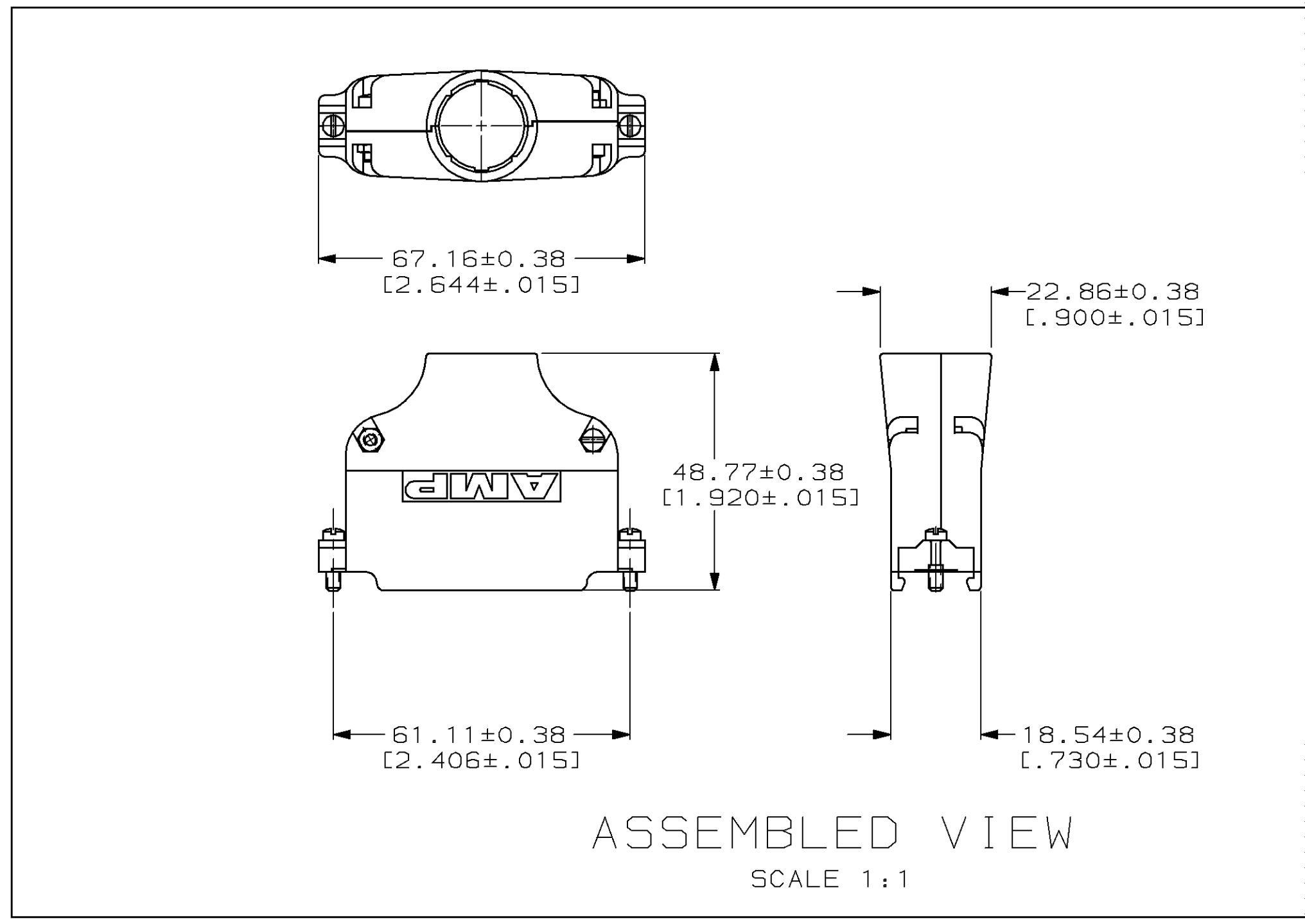
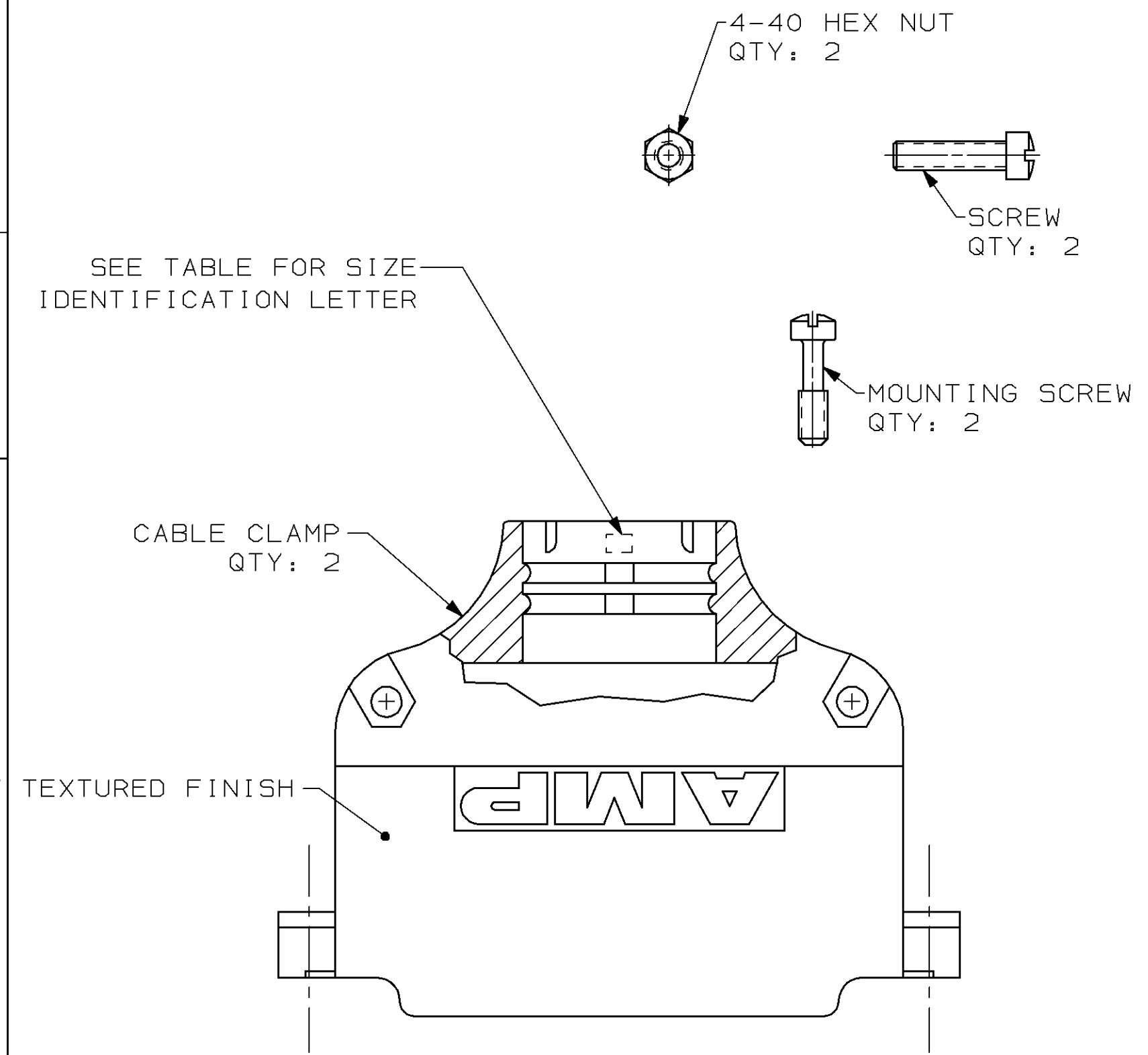

- ① SCREW: CARBON STEEL.
MOUNTING SCREW & HEX NUT: CARBON STEEL PER ASTM A108.
CABLE CLAMP: ZINC.
- ② SCREW: ZINC PLATED.
MOUNTING SCREW & HEX NUT: 5.08µm [.000200] MIN ZINC PER, ASTM B633 TYPE III, CLASS SCI, CLEAR CHROMATE.
CABLE CLAMP: 5.08µm [.000200] MIN NICKEL PER QQ-N-290 OVER 5.08µm [.000200] MIN COPPER PER MIL-C-14550.

I	9.53 [.375]	745175-6
L	11.43 [.450]	745175-5
O	13.34 [.525]	745175-4
S	15.24 [.600]	745175-3
U	17.15 [.675]	745175-2
V	19.05 [.750]	745175-1
	NECK SIZE I.D.	CABLE DIA
		PART NO

DO NOT SCALE PRINT. UNLESS SPECIFIED DIMENSIONS IN mm [INCHES] TOLERANCES ON : 2 PLC DEC ± .013 [.005] 3 PLC DEC ± - ANGLES ± -	DR 09-15-93 D.BROCKWAY	AMP Incorporated Harrisburg, PA 17105-3608		
	CHK 09-17-93 B.LENKER			
MATERIAL ① -	APPD 09-17-93 S.BRINSER	NAME CABLE CLAMP KIT, UNASSEMBLED SIZE 5, 50 POSN, 180° AMPLIMITE™		
	APPD 09-17-93 S.BRINSER			
FINISH ② -	PRODUCT SPEC -	SIZE C	CAGE CODE 00779	DRAWING NO G=745175
	APPLICATION SPEC -	SCALE 2:1	SHEET 1 OF 1	
WEIGHT -				

THIS DRAWING IS A CONTROLLED DOCUMENT FOR AMP INCORPORATED. IT IS SUBJECT TO CHANGE AND THE CONTROLLING ENGINEERING ORGANIZATION SHOULD BE CONTACTED FOR THE LATEST REVISION.