

THIS DRAWING IS UNPUBLISHED. RELEASED FOR PUBLICATION 2012
 © COPYRIGHT 2012 BY TE CONNECTIVITY ALL RIGHTS RESERVED.

LOC		DIST		REVISIONS			
P	LTR	DESCRIPTION	DATE	DWN	APVD		
	F2	REVISED PER ECO-18-013833	17DEC2018	RS	MD		

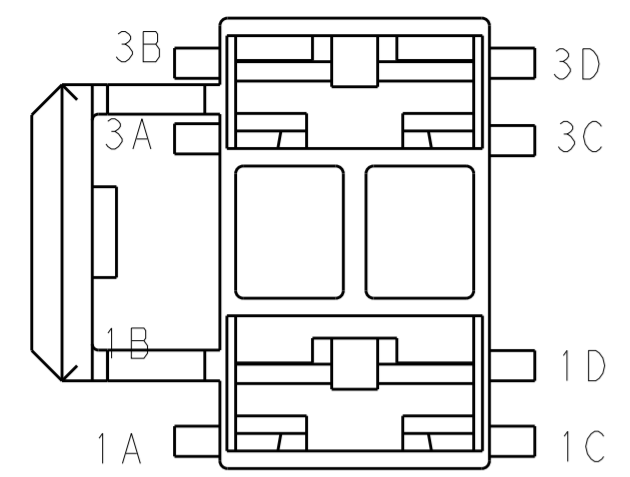

SPECIAL REAR VIEW THAT MATES WITH THE HEADER VIEWS BELOW SHOWING THE KEYING & POLARIZATION

2.79
[.110]

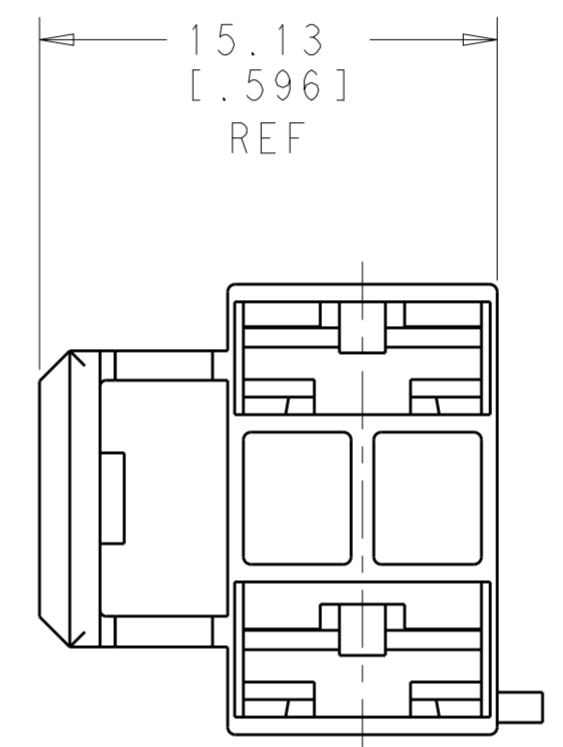
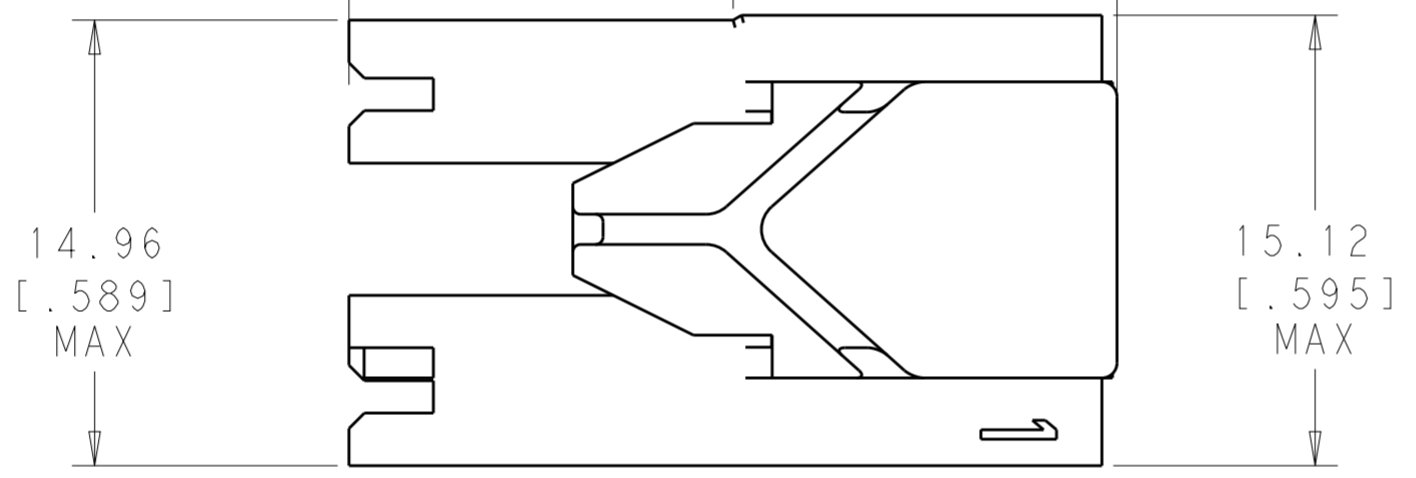
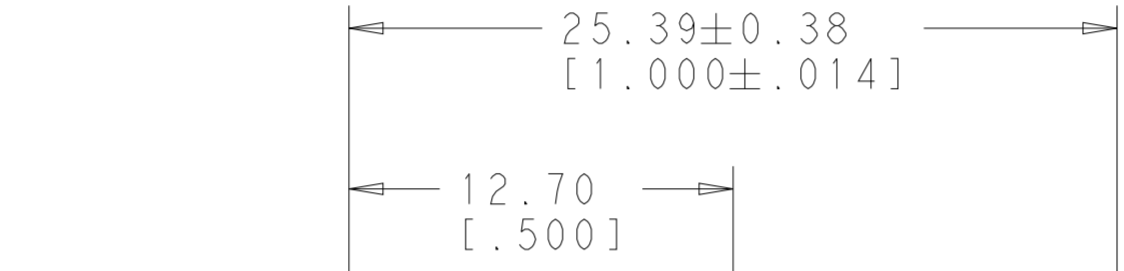
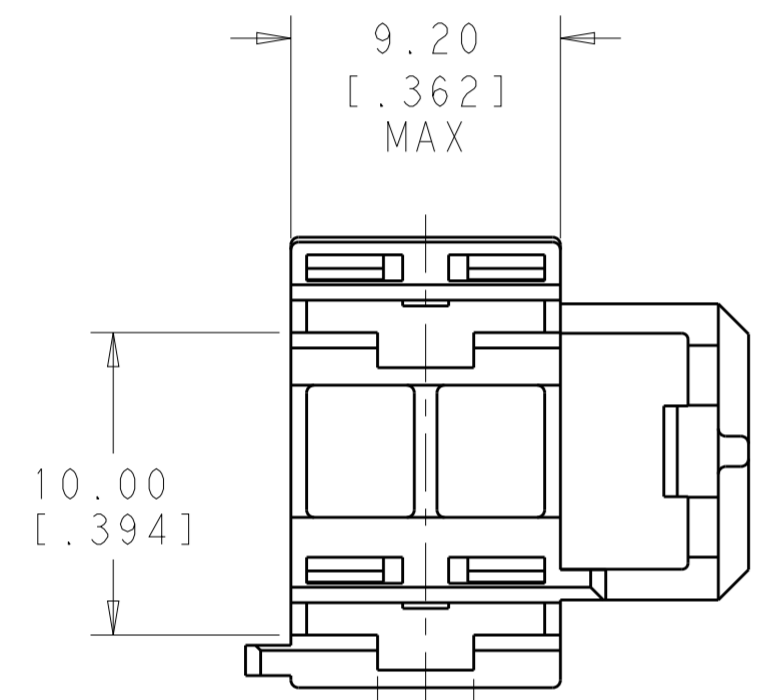
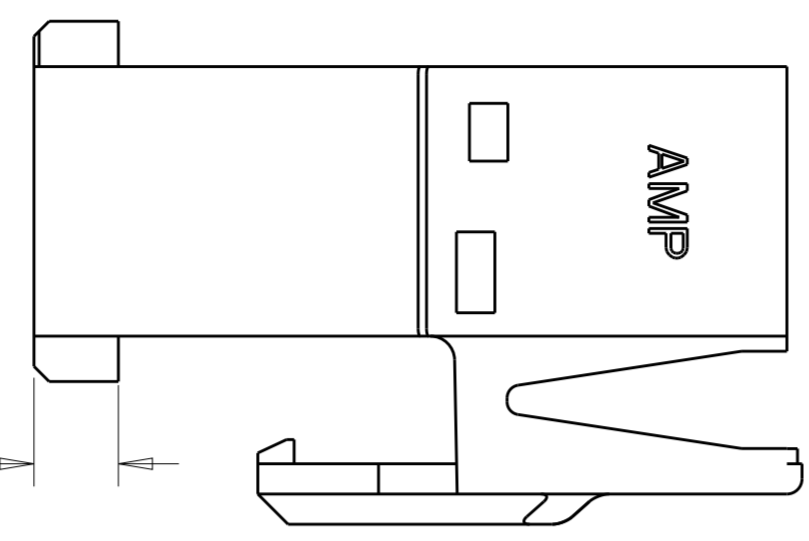

3.18±0.38
[.125±.014]

- 1 ACCORDING TO IEC 60335-1, GWPT 750°C WITHOUT FLAME
- 2 PRELIMINARY - NOT FOR PRODUCTION
- 3 DELETED NOTE
- 4 DELETED NOTE
- 5 ACCEPTS RECEPTACLES 2238135, 2238136, 1217378, 1217094 AND 1217095
- 6 OBSOLETE PARTS

1	1C, 3C	NONE	GRAY	5-1969536-6
1	1C	1A	BLUE	5-1969536-5
1	1C	1B	BLACK	5-1969536-4
1	1D, 3D	NONE	NATURAL	5-1969536-3
1	3C	1A	YELLOW	5-1969536-2
1	1C, 3C	NONE	GREEN	5-1969536-1
6	1C, 3C	NONE	GRAY	5-1969536-6
6	1C	1A	BLUE	5-1969536-5
6	1C	1B	BLACK	5-1969536-4
6	1D, 3D	NONE	NATURAL	5-1969536-3
6	3C	1A	YELLOW	5-1969536-2
6	1C, 3C	NONE	GREEN	5-1969536-1
	KEYING FEATURE	POLARIZATION FEATURE	COLOR	PART NUMBER

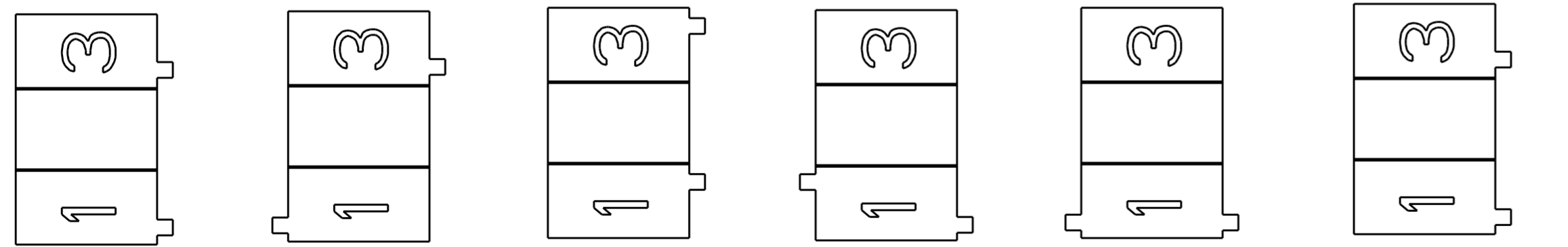

5-1969536-1 5-1969536-2 5-1969536-3 5-1969536-4 5-1969536-5 5-1969536-6

HEADER VIEWS

THIS DRAWING IS A CONTROLLED DOCUMENT.

DWN	JR RUTH	19JUN2012	TE Connectivity			
CHK	F LUPO	15MAR2017				
APVD	R ROBONE	15MAR2017				
NAME	HOUSING, RECEPT, POSI-LOCK MK III, 6.35 [.250] SERIES, 3 POSITION, 2 CIRCUIT					
DIMENSIONS:	TOLERANCES UNLESS OTHERWISE SPECIFIED:		SIZE	CAGE CODE	DRAWING NO	RESTRICTED TO
mm [INCHES]	0 PLC ± 1 PLC ± 2 PLC ±0.25 [.010] 3 PLC ± 4 PLC ± ANGLES ± FINISH		A2	00779	C-1969536	
MATERIAL	NYLON SEE TABLE		WEIGHT	Customer Drawing		SCALE 4:1 SHEET 1 OF 1 REV F2