



# DEUTSCH CTJ Series Common Termination System

AS81714 Series II Qualified Products Offer Robust and Highly Reliable Wire Termination in Demanding Environments

# DEUTSCH CTJ Series

## Common Termination Systems — AS81714 Series II

### Contents

|  |          |
|--|----------|
| <b>INTRODUCTION</b>                                  | <b>3</b> |
| <hr/>  |          |
| <b>MODULES</b>                                       |          |
| CTD and CTJ1 Power Distribution and Feedback Modules | 6        |
| CTJ4 Series Electronic Component Modules             | 9        |
| CTJ5 Series Board-Mount/Pluggable Modules            | 19       |
| CTJ6 and CTJ9 Series Plug and Receptacle Connectors  | 22       |
| CTJ7 and CTG Series Grounding Modules and Junctions  | 26       |
| CTL, CTM, and CTN Series In-Line Junctions           | 29       |
| Composite In-line Junctions                          | 32       |
| Adapter Junctions                                    | 35       |
| <hr/>  |          |
| <b>RAILS</b>   |          |
| CTJ2 Series Metallic Single-Module Rails             | 37       |
| CTJ3 Series Metallic Rails                           | 38       |
| DCR Series Composite Rails                           | 40       |
| <hr/>  |          |
| <b>CONTACTS AND TOOLING</b>                          |          |
| Socket Contacts                                      | 42       |
| CTJ Series Tooling                                   | 43       |
| <hr/>  |          |
| <b>CROSS REFERENCE</b>                               |          |
| DEUTSCH CTJ to AS8171                                | 46       |



#### RUGGED

- Many parts qualified to SAE-AS81714
- Integrated bus bar technology

#### ENVIRONMENTALLY SEALED

- Resists fluids commonly found in aerospace and defense applications
- Helps prevent foreign object debris issues

#### EASY TO USE

- Insertable modules that can be easily removed and reinserted into rails with tools

#### APPLICATIONS

- Commercial Air
- Space
- Military Ground
- Military Aerospace



The DEUTSCH CTJ Series common termination system from TE Connectivity (TE) is a system of wires and components that are interconnected to one another by the use of a standard AS39029 socket contact only. This eliminates the need for pin contacts which are located in the mating components. Bussed cavities use our single-pin bus bar design. There are multiple design options available to customize the modules, junctions, splices and rails available in Mil Spec-approved AS81714 Series II and non-qualified proprietary designs.

#### TE Advantage

**DEUTSCH AS39029 Contacts.** All assemblies—modules, splices, etc.—are supplied with DEUTSCH AS39029 socket contacts, which are designed to meet AS39029 standard for ruggedness and vibration resistance.

**Customization.** Products can be customized to help meet your specific needs.

**Single Rail Assembly.** We offer rail assemblies for single-mount components.

**Easy Assembly.** We offer easy insertion and removal of single rails inside multimodule assemblies.

#### TE Components . . . TE Technology . . . TE Know-how . . .

AMP | AGASTAT | CII | HARTMAN | KILOVAC | MICRODOT | NANONICS | POLAMCO | Raychem  
SEACON | Rochester | DEUTSCH

Empower Engineers to Solve Problems, Moving the World Forward.

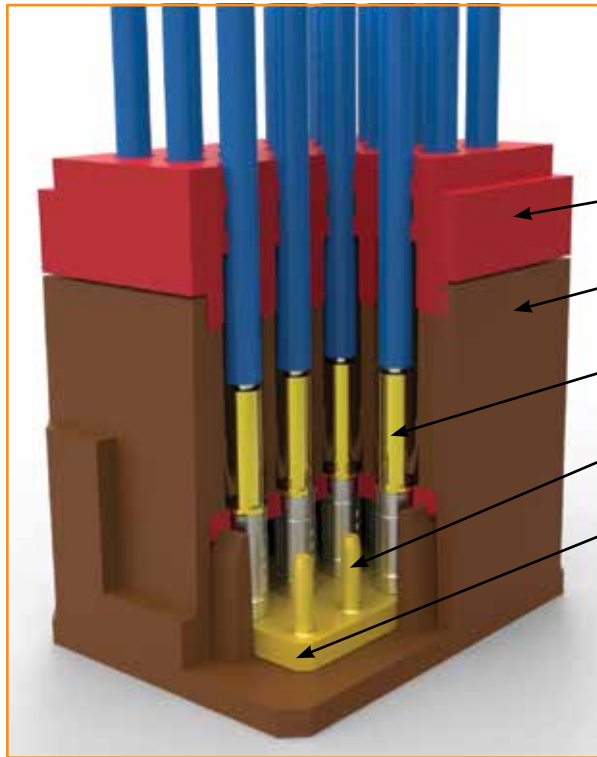

Environmentally Sealed Grommet

Housing

Wire-Applied AS39029 Socket Contact

Integral Pin Contact

Bussted Cavities Single Pin Bus Bar

**CTD Bussing Modules** for power distribution.

**CTJ1 Feedback Modules** with various bussing arrangements.

**CTJ4 Electronic Component Modules** design based upon Mil-T-81714/62 electronic modules. Modules are available with a variety of diodes, resistors, capacitors, and fuses, with both M81714/62 equivalents and additional configurations.

**CTJ5 Board-Mount Modules** include solder pin contacts for direct mounting to pc boards and flex cable. By eliminating the need for a mounting rail, CTJ5 modules provide a flexible and compact solution.

**CTJ6 Plug and CTJ9 Receptacle Connectors** provide a small, lightweight method of connecting/disconnecting multiple wires. Available in flange-mount and in-line versions.

**CTJ7 Grounding Modules**, using either flange mount or stud mount, provide sealed multiwire grounding solutions.

**CTJ2 Metallic Mounting Bracket** are aluminum alloy and designed to hold one single module or two half-size modules.

**CTJ3 Metallic Rails** use aluminum alloy and stainless steel clips. They are available with a variety of finishes and sizes ranging from 2 to 40 inches.

**DCR Composite Rails** are a lightweight alternative to CTJ3 rails, offering up to 48% weight savings and available in lengths from 2 to 20 inches.

#### Junctions and Splices

**CTL, CTM and CTN In-Line Junctions** connect two to four wires in-line and multijunctions for housing and sealing individual components. The CTL is an in-line junction for single wires. The CTM connects and buses two, three, or four wires. The CTN series connects contacts electrically with diodes, capacitors, fuses, or resistors.

**Composite In-Line Junctions** are composite versions of the CTL, CTM, and CTN series with electronic components design-in customization.

**CTJ Grounding Junctions** provide a simple method of terminating wire to ground using standard AS39029 contacts.



### CTJ Mil Spec Series General Specifications

The CTJ Mil Spec Series meet requirements of SAE-AS81714.

**Dielectric Withstanding Voltage** (AS81714 paragraph 3.5.6):

- At Sea Level: 1500 VAC<sub>rms</sub>
- At 110,000 Ft: 200 VAC<sub>rms</sub>

**Insulation Resistance** (AS81714 paragraph 3.5.11): 5000 MΩ min. at 25°C

**Operating Temperature:** -65°C to +200°C

**Physical Shock:** 78 g in each of the 3 mutually perpendicular planes

**Vibration:** Maintains continuity to minimize mechanical or physical damage during or after vibration following vibration levels

**Level 1—34 minutes per axis**

- 20–90 Hz at 6 dB/oct. rise
- 90–300 Hz at 1.0 g<sup>2</sup>/Hz
- 300–2000 Hz at 6 dB/oct. fall

**Level 2—14 minutes per axis**

- 20–40 Hz at 6 dB/oct. rise
- 40–350 Hz at 0.5 g<sup>2</sup>/Hz
- 350–2000 Hz at 6 dB/oct. fall
- No discontinuities greater than 1 microsecond

**Corrosion:** 48 hours of salt spray

**Magnetic Permeability:** 2.0 μ max.

**Fluid Resistance:**

- MIL-PRF-5606: Hydraulic fluid
- MIL-DTL-83133: JP-8 aviation fuel
- MIL-PRF-7808: Lubricating oil
- MIL-PRF-23699: Lubricating oil
- MIL-A-8243: Deicing/defrosting fluid
- MIL-C-25769: Aircraft cleaning compound
- MIL-PRF-87937: Aircraft cleaning compound
- MIL-G-3056: Gasoline

### Materials

**Housing:** Composite

**Bus Bar/Pins:** Copper alloy, plated gold

**Sealing Grommet:** Elastomer, fluid resistant and environmentally sealed

**Metal Rails (CTJ2 and CTJ3):** Aluminum alloy, nickel plated (standard). Also available with anodized, olive drab cadmium, or clear finishes. Stainless steel clips

**DCR Rails:** Composite

### Contact Resistance (at 25°C)

Meets AS39029 paragraph 3.5.4

| Wire Size | Test Current | Voltage Drop |
|-----------|--------------|--------------|
| 22 AWG    | 5 A          | 73 mV        |
| 20 AWG    | 7.5 A        | 55 mV        |
| 16 AWG    | 13 A         | 50 mV        |
| 12 AWG    | 23 A         | 42 mV        |

### Usable Wire Size

Meets AS39029 paragraph 3.4.2

| Contact | Wire Range (AWG) | Current Rating |
|---------|------------------|----------------|
| Size 22 | 26–22            | 5 A            |
| Size 20 | 24–20            | 7.5 A          |
| Size 16 | 16–20            | 13 A           |
| Size 12 | 14–12            | 3 A            |

### Grommet Sealing Range

| Contact Size | Wire OD |       |
|--------------|---------|-------|
|              | Min.    | Max.  |
| 22           | 0.030   | 0.060 |
| 20           | 0.040   | 0.083 |
| 16           | 0.065   | 0.109 |
| 12           | 0.097   | 0.142 |



## DEUTSCH CTD and CTJ1 Power Distribution and Feedback Modules

### EASY TO USE

- Busses 6 to 20 contacts in a small area
- Internal bus bars are configured to allow connections of various combinations of wires

### RUGGED

- Uses a rugged A39029 socket contact mated to one-piece (cold-headed) internal pin bus bars
- Excellent vibration resistance
- Environmentally sealed

### CONVENIENT

- Modules fit in single, multiple, composite or metal rails with multiple mounting options
- CTD distribution modules accommodate different sizes of contacts within the same bus

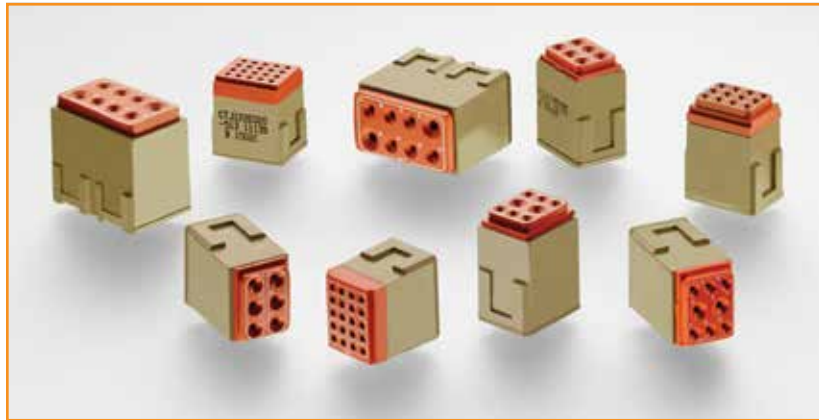

CTD power distribution and CTJ feedback modules for rugged, environmentally sealed bussing of wires.

### Specifications

**Dielectric Withstanding Voltage** (AS81714 paragraph 3.5.6):

At Sea Level: 1500 VAC<sub>rms</sub>  
At 110,000 Ft: 200 VAC<sub>rms</sub>

**Insulation Resistance** (AS81714 paragraph 3.5.11): 5000 M $\Omega$  min. at 25°C

**Operating Temperature:** -65°C to +200°C

**Vibration:** Maintains continuity to minimize mechanical or physical damage during or after vibration levels stated in tested specifications

**Corrosion:** 48 hours of salt spray

**Fluid Resistance:**

MIL-PRF-5606: Hydraulic fluid  
MIL-DTL-83133: JP-8 aviation fuel  
MIL-PRF-7808: Lubricating oil  
MIL-PRF-23699: Lubricating oil  
MIL-A-8243: Deicing/defrosting fluid  
MIL-C-25769: Aircraft cleaning compound  
MIL-PRF-87937: Aircraft cleaning compound  
MIL-G-3056: Gasoline

### Materials

**Housing:** Composite

**Bus Bar/Pins:** Copper alloy, plated gold

**Pin Contacts:** Gold over copper

**Sealing Grommet:** Elastomer, fluid resistant and environmentally sealed



**Contact Resistance (at 25°C)**  
Meets AS39029 paragraph 3.5.4

| Wire Size | Test Current | Voltage Drop |
|-----------|--------------|--------------|
| 22 AWG    | 5 A          | 73 mV        |
| 20 AWG    | 7.5 A        | 55 mV        |
| 16 AWG    | 13 A         | 50 mV        |
| 12 AWG    | 23 A         | 42 mV        |

**Grommet Sealing Range**

| Contact Size | Wire OD |       |
|--------------|---------|-------|
|              | Min.    | Max.  |
| 22           | 0.030   | 0.060 |
| 20           | 0.040   | 0.083 |
| 16           | 0.065   | 0.109 |

**Usable Wire Size**

Meets AS39029 paragraph 3.4.2

| Contact | Wire Range (AWG) | Current Rating |
|---------|------------------|----------------|
| Size 22 | 26-22            | 5 A            |
| Size 20 | 24-20            | 7.5 A          |
| Size 16 | 16-20            | 13 A           |
| Size 12 | 14-12            | 3 A            |

**CTD Series**

**Distribution Bussing Arrangements**

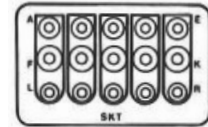
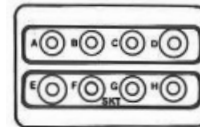
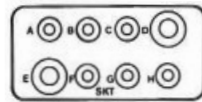

| Part No.                   | CTD126E01A                  | CTD160E01F                  | CTD126E02E                  | CTD1062E05A                         |
|----------------------------|-----------------------------|-----------------------------|-----------------------------|-------------------------------------|
| <b>No. of Busses</b>       | 1                           | 1                           | 2                           | 5                                   |
| <b>Contacts per Bus</b>    | 2 Size 12<br>6 Size 16<br>— | 2 Size 16<br>6 Size 20<br>— | 1 Size 12<br>3 Size 16<br>— | 1 Size 12<br>1 Size 20<br>1 Size 22 |
| <b>Distribution Bus</b>    | 26                          | 60                          | 26                          | 062                                 |
| <b>Bussing Arrangement</b> | 01A                         | 01F                         | 02E                         | 05A                                 |

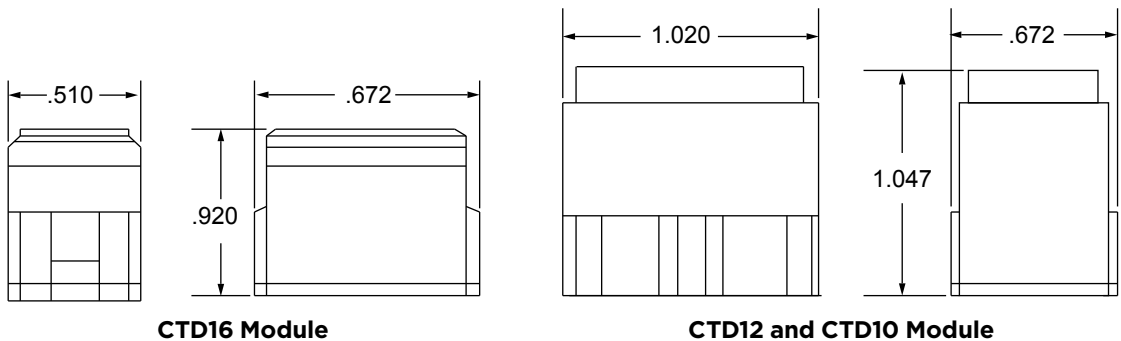

**Part Numbering System**

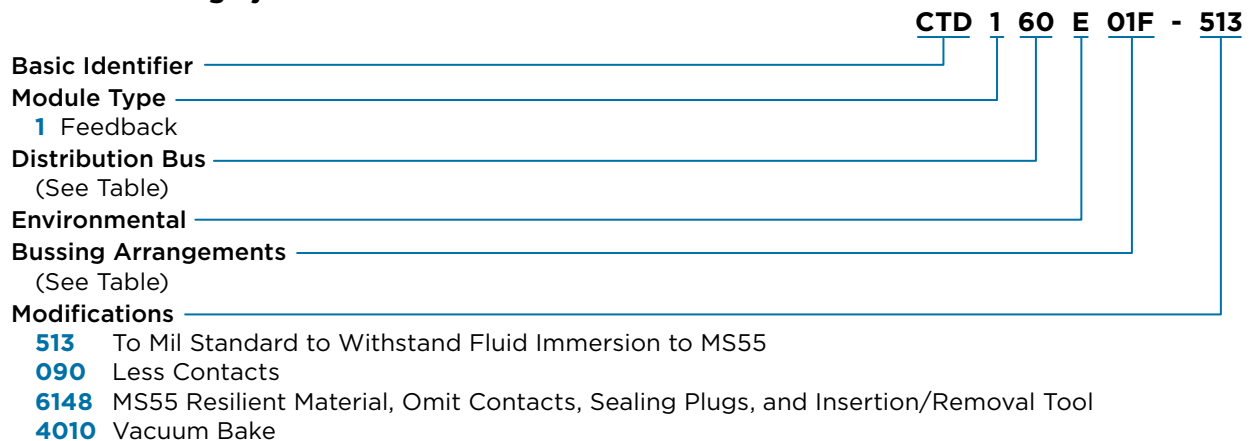



**CTJ1 Series**

**Feedback Bussing Arrangements**

|                                  |               |     |     |     |     |     |   |
|----------------------------------|---------------|-----|-----|-----|-----|-----|---|
| Size 22 Contacts<br>Quantity: 20 |               |     |     |     |     |     |   |
|                                  | No. of Busses | 1   | 2   | 5   | 6   | 10  | 4 |
| Bus Code                         | 01C           | 02D | 05E | 06B | 10A | 04F |   |

|                                  |               |     |     |     |     |   |
|----------------------------------|---------------|-----|-----|-----|-----|---|
| Size 20 Contacts<br>Quantity: 12 |               |     |     |     |     |   |
|                                  | No. of Busses | 1   | 2   | 3   | 4   | 6 |
| Bus Code                         | 01B           | 02C | 03D | 04A | 06E |   |

|                                 |               |     |     |   |
|---------------------------------|---------------|-----|-----|---|
| Size 16 Contacts<br>Quantity: 6 |               |     |     |   |
|                                 | No. of Busses | 1   | 2   | 3 |
| Bus Code                        | 01D           | 02B | 03A |   |

|                                 |               |     |     |   |
|---------------------------------|---------------|-----|-----|---|
| Size 12 Contacts<br>Quantity: 6 |               |     |     |   |
|                                 | No. of Busses | 1   | 2   | 3 |
| Bus Code                        | 01E           | 02A | 03B |   |

**CTJ1 Outline Dimensions**

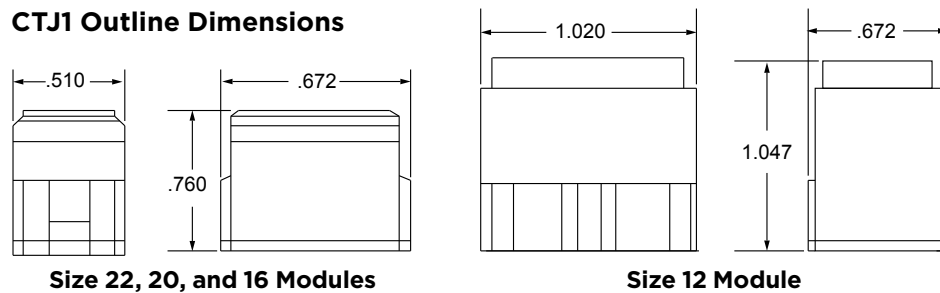

**Part Numbering System**

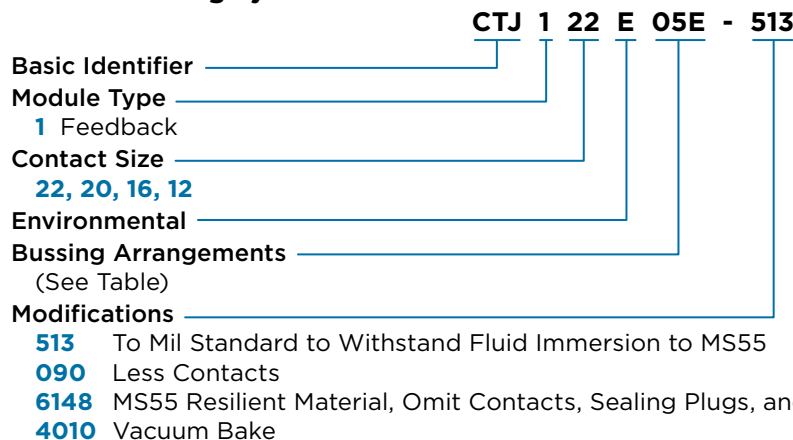

**Ordering Information**

| Module  | Part No.       |
|---------|----------------|
| Size 22 | CTJ122Exxx-yyy |
| Size 20 | CTJ120Exxx-yyy |
| Size 16 | CTJ116Exxx-yyy |
| Size 12 | CTJ112Exxx-yyy |

xxx = bussing arrangements  
yyy = modification codes





## DEUTSCH CTJ4 Series Electronic Component Modules

### CONVENIENT

- May be placed near transient suppression devices that they are designed to protect
- Each module houses small printed circuit boards incorporating a variety of discrete electronic components
- Uses crimp-tool terminations and a housing system for discrete components and circuits
- Lightweight composite technology for weight-saving solutions

### ROBUST

- Fluid resistant in most military or aerospace environments
- Input/output wiring is sealed with elastomer grommet to help protect against environmental hazards
- Designed to the electronic requirements of MIL-T-81714/62

### VERSATILE

- Available with a variety of discrete electronic components with both M81714/62 equivalents and additional configurations



CTJ4 electronic component modules are designed to the requirements of MIL-T-81714/62. Modules are available with a variety of diodes, resistors, capacitors and fuses, with both M81714/62 equivalents and additional configurations.

### Specifications

**Operating Temperature:** -65°C to +200°C or IAW Electronic Component (whichever has the lesser requirement)

**Thermal Shock and Vibration:** In accordance with AS81714 or in accordance with electronic component (whichever has the lesser requirement)

#### Fluid Resistance:

- MIL-PRF-5606: Hydraulic fluid
- MIL-DTL-83133: JP-8 aviation fuel
- MIL-PRF-7808: Lubricating oil
- MIL-PRF-23699: Lubricating oil
- MIL-A-8243: Deicing/defrosting fluid
- MIL-PRF-87937: Aircraft cleaning compound
- MIL-G-3056: Gasoline

### Materials

**Housing:** Composite

**Pin Contacts:** Gold over copper

**Sealing Grommet:** Elastomer, fluid resistant and environmentally sealed



**Usable Wire Size**

Meets AS39029 paragraph 3.4.2

| Contact | Wire Range (AWG) | Current Rating |
|---------|------------------|----------------|
| Size 20 | 24-20            | 7.5 A          |
| Size 12 | 14-12            | 3 A            |

**Part Numbering System**

**CTJ4 20 E 017 - 513**

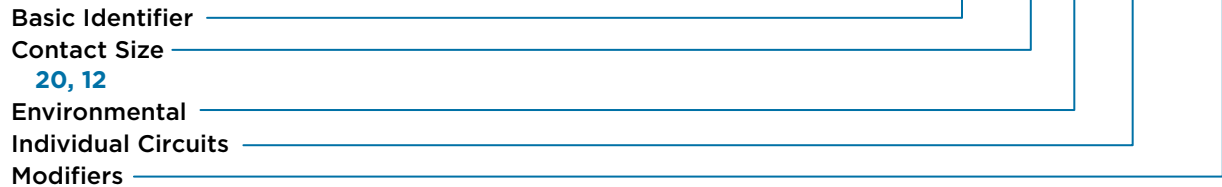

- 513** Elastomer change to meet AS81714 Fluid Requirements
- 090** Less Contacts
- 6148** Elastomer change to meet AS81714 Fluid requirements, less scontacts, less sealing Plugs and less Insertion/Removal Tools
- 4010** Vacuum Bake

**Ordering Information**

| Contact | Part No.        |
|---------|-----------------|
| Size 20 | CTJ420E-xxx-yyy |
| Size 12 | CTJ412E-xxx-yyy |

xxx = individual electronic circuits  
yyy = modification code

**Outline Dimensions**

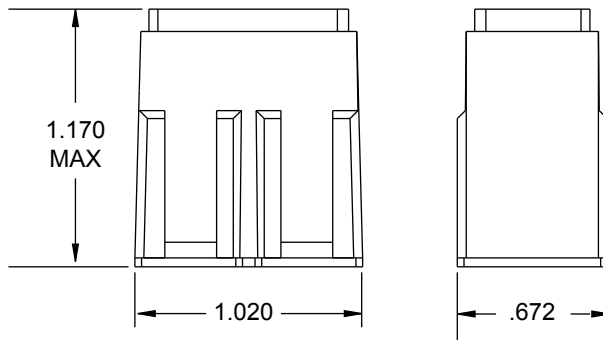

**CTJ4 Modules**



CTJ4 Circuit Configurations

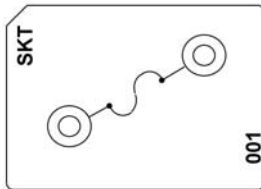

**CTJ412E001**  
One 15 A, 125 V Fuse

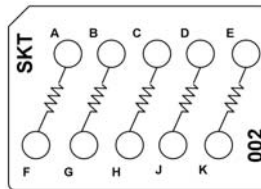

**CTJ420E002**  
Five 150  $\Omega$  Resistors, 1/4 W

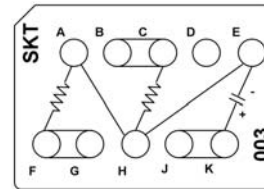

**CTJ420E003**  
Two 150  $\Omega$  Resistors, 1/4 W  
One 10  $\mu$ F Capacitor, 35 WVDC

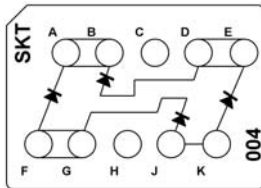

**CTJ420E004**  
One VE08 Rectifier

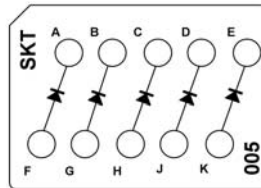

**CTJ420E005**  
Five JANTX 1N4246 or  
JANTX 1N5616 Diodes

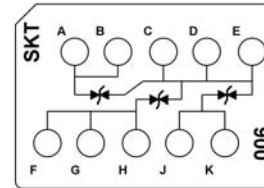

**CTJ420E006**  
Three JANTX 1N6054A  
Zener Diodes

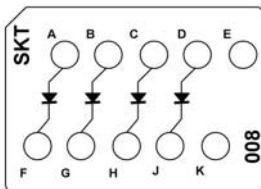

**CTJ420E008**  
Four JANTX 1N3613 Diodes

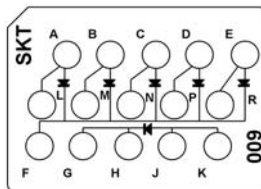

**CTJ420E009**  
Six JANTX 1N5618 Diodes

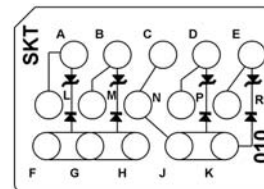

**CTJ420E010**  
Four JANTX 1N5618 Diodes  
Four JANTX 1N4478 Zener Diodes

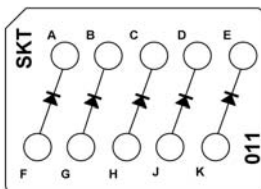

**CTJ420E011**  
Five JANTX 1N5618 Diodes

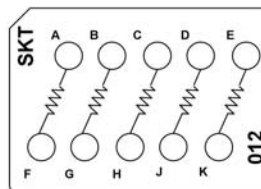

**CTJ420E012**  
Five 10 k $\Omega$  Resistors, 1/10 W

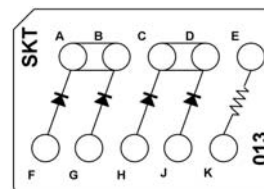

**CTJ420E013**  
Four JANTX 1N5618 Diodes  
One 200  $\Omega$  Resistor, 1/8 W

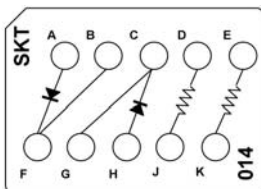

**CTJ420E014**  
Two RNC55H1002BP Diodes  
Two 10 k $\Omega$  Resistors, 1/10 W

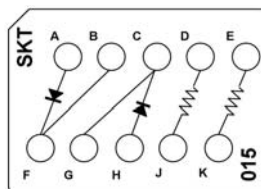

**CTJ420E015**  
Two JANTX 1N5618 Diodes  
One 10 k $\Omega$  Resistor, 1/10 W  
One 110  $\Omega$  Resistor, 1/10 W

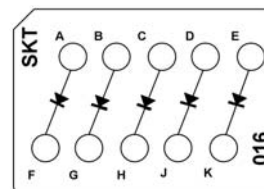

**CTJ420E016**  
Five JANTX 1N5618 Diodes



**CTJ4 Circuit Configurations**

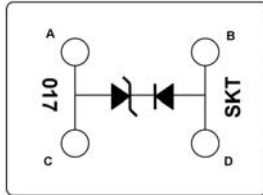

**CTJ420E017**  
One JANTX 1N5618 Diode  
One JANTX 1N4478 Zener Diode

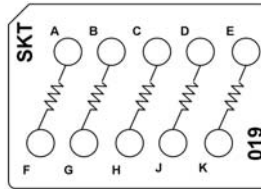

**CTJ420E019**  
One 1.10 kΩ Resistor, 1/10 W  
One 1.40 kΩ Resistor, 1/10 W  
One 20 kΩ Resistor, 1/10 W  
Two 10 kΩ Resistors, 1/10 W

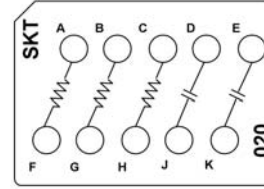

**CTJ420E020**  
Two 3.6 kΩ Resistors, 1/10 W  
One 100 kΩ Resistor, 1/10 W  
Two 1 μF Capacitors, 50 WVDC

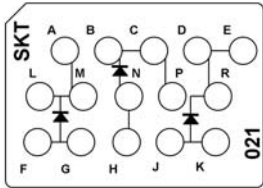

**CTJ420E021**  
Three JANTX 1N5550 Diodes

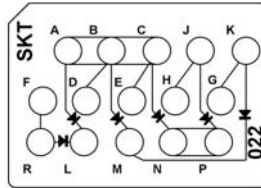

**CTJ420E022**  
Six JANTX 1N5809 Diodes

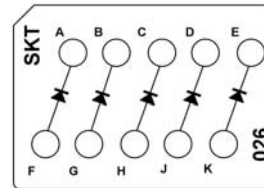

**CTJ420E026**  
Five JANTX 1N5620 Diodes

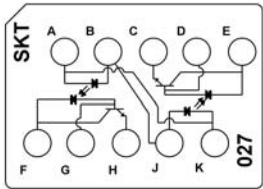

**CTJ420E027**  
Two 66099-108 or  
66139-101 ISO Cubes

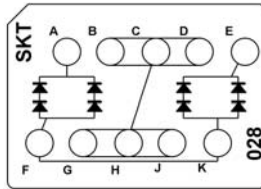

**CTJ420E028**  
Eight JANTX 1N5550 Diodes

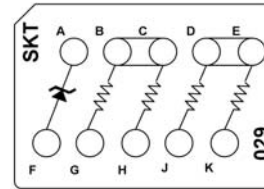

**CTJ420E029**  
Two 10 kΩ Resistors, 1/10 W  
Two 1.43 kΩ Resistors, 1/10 W  
One JANTX1N4954 Zener Diode

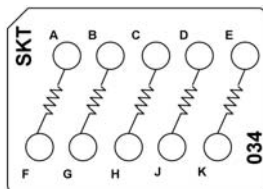

**CTJ420E034**  
Five 150 Ω Resistors, 1/10 W

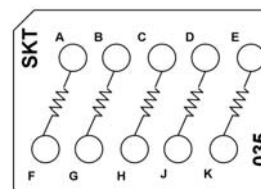

**CTJ420E035**  
Five 10.2 kΩ Resistors, 1/10 W

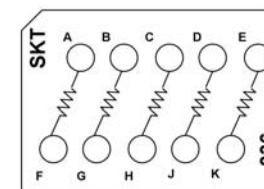

**CTJ420E036**  
Five 2.8 kΩ Resistors, 1/10 W

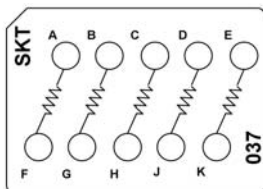

**CTJ420E037**  
Five 23.2 kΩ Resistors, 1/20 W

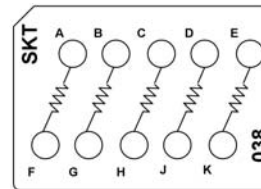

**CTJ420E038**  
Five 24.9 kΩ Resistors, 1/20 W

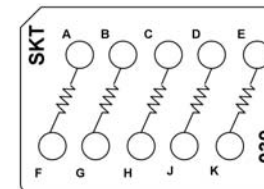

**CTJ420E039**  
Five 41.2 kΩ Resistors, 1/20 W



**CTJ4 Circuit Configurations**

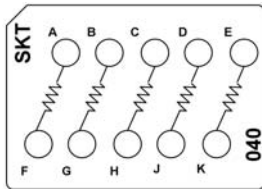

**CTJ420E040**  
Five 49.9 kΩ Resistors, 1/20 W

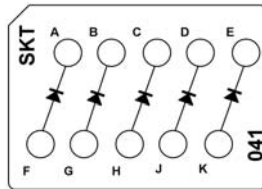

**CTJ420E041**  
Five JANTX 1N5550 Diodes

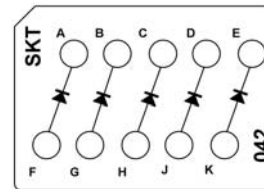

**CTJ420E042**  
Five JANTX 1N5418 Diodes

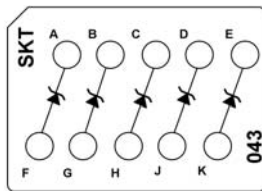

**CTJ420E043**  
Five JANTX 1N827 Zener Diodes

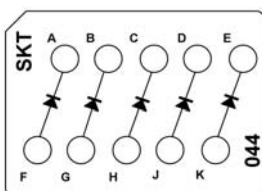

**CTJ420E044**  
Five JANTX 1N5552 Diodes

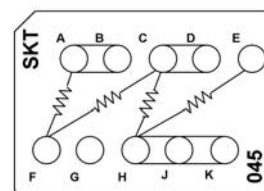

**CTJ420E045**  
Two 40 kΩ Resistors, 1/10 W  
Two 50 kΩ Resistors, 1/10 W

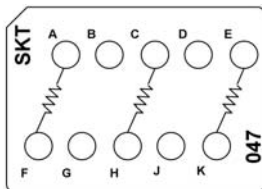

**CTJ420E047**  
Three 60.4 or 59 Ω Resistors, 2 W

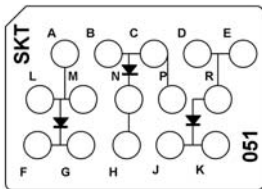

**CTJ420E051**  
Three JANTX 1N5618 Diodes

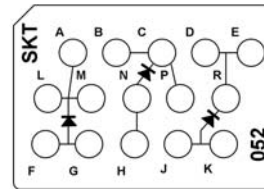

**CTJ420E052**  
Three JANTX 1N5618 Diodes

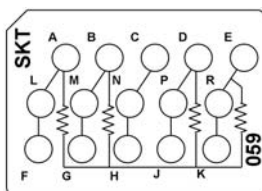

**CTJ420E059**  
Four 150 Ω Resistors, 1/4 W

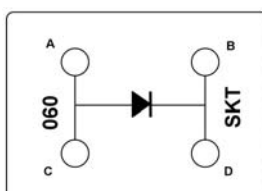

**CTJ420E060**  
One JANTX 1N5618 Diode

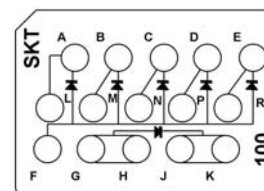

**CTJ420E100**  
Six JANTX 1N5618 Diodes

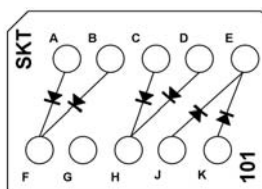

**CTJ420E101**  
Six JANTX 1N3613 Diodes

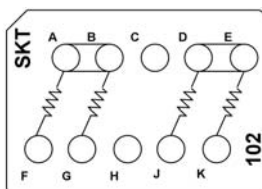

**CTJ420E102**  
Two 20 kΩ Resistors, 1/4 W  
Two 8.45 kΩ Resistors, 1/4 W

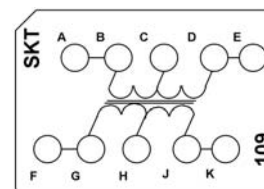

**CTJ420E109**  
One MIL-T-27/172-45  
Transformer



### CTJ4 Circuit Configurations

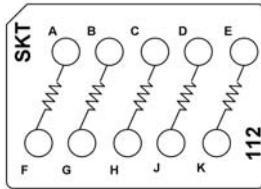

**CTJ420E112**  
Five 150  $\Omega$  Resistors, 1/4 W

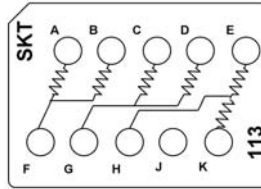

**CTJ420E113**  
Six 4.7 k $\Omega$  Resistors, 1/4 W

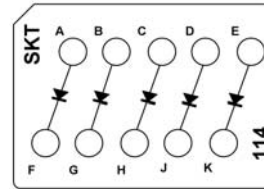

**CTJ420E114**  
Five JANTX 1N4247 Diodes

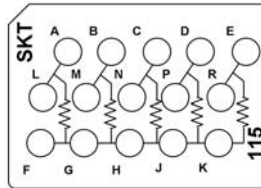

**CTJ420E115**  
Five 6.2 k $\Omega$  Resistors, 1/4 W

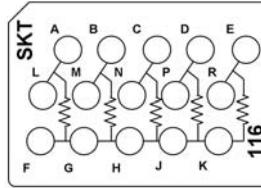

**CTJ420E116**  
Five 3 k $\Omega$  Resistors, 1/4 W

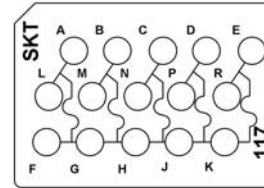

**CTJ420E117**  
Five 5 A Fuses, 125 V

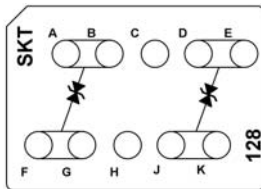

**CTJ420E128**  
Two JANTX 1N6052A  
Zener Diodes

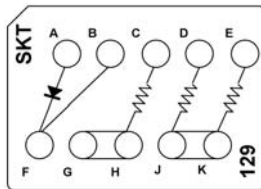

**CTJ420E129**  
One JANTX 1N5618 Diode  
Three 10 k $\Omega$  Resistors, 1/8 W

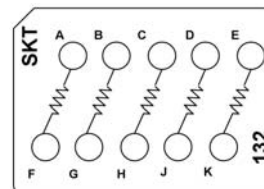

**CTJ420E132**  
Five 150  $\Omega$  Resistors, 1/2 W

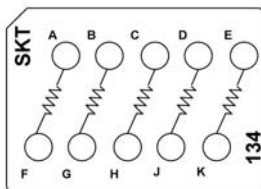

**CTJ420E134**  
Three 150  $\Omega$  Resistors, 1/2 W  
One 51  $\Omega$  Resistor, 1/2 W  
One 820  $\Omega$  Resistor, 2 W

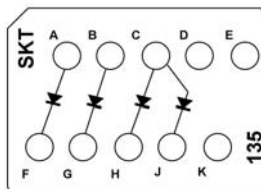

**CTJ420E135**  
Four JANTX 1N5551 Diodes

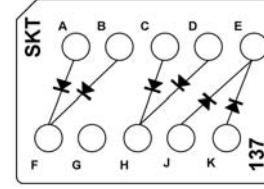

**CTJ420E137**  
Six JANTX 1N6419-1 Diodes

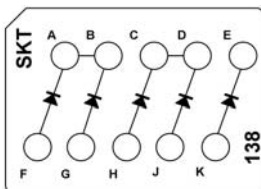

**CTJ420E138**  
Five JANTX 1N5618 Diodes

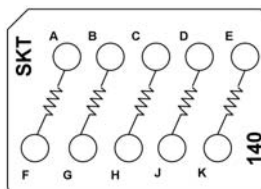

**CTJ420E140**  
Five 5.1 k $\Omega$  Resistors, 1/10 W

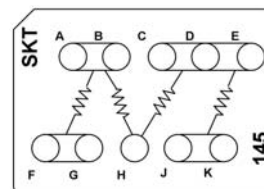

**CTJ420E145**  
Two 100 k $\Omega$  Resistors, 1/4 W  
Two 7.5 k $\Omega$  Resistors, 1/4 W



CTJ4 Circuit Configurations

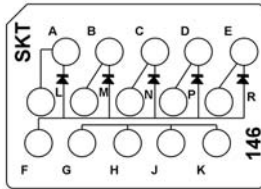

**CTJ420E146**  
Five JANTX 1N5618 Diodes

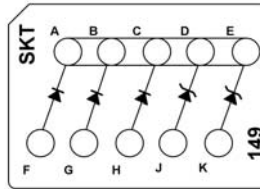

**CTJ420E149**  
Three JANTX 1N5616 Diodes  
Two JANTX 1N4461 Zener Diodes

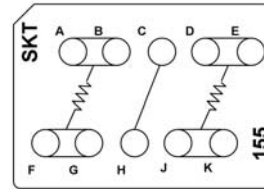

**CTJ420E155**  
Two 1 kΩ Resistors, 1/4 W

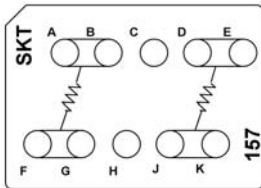

**CTJ420E157**  
Two 120 Ω Resistors, 1/4 W

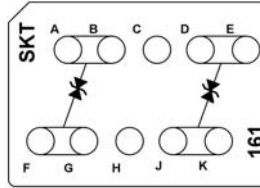

**CTJ420E161**  
Two JANTX 1N6059A  
Zener Diodes

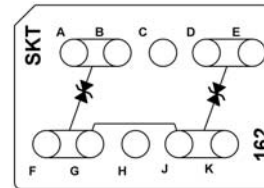

**CTJ420E162**  
Two JANTX 1N6067A  
Zener Diodes

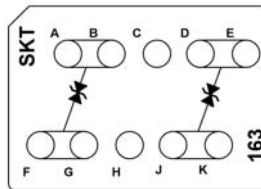

**CTJ420E163**  
Two JANTX 1N6045A  
Zener Diodes

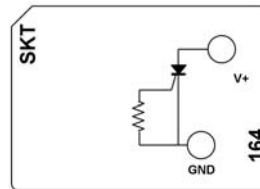

**CTJ420E164**  
One JANTX 2N2323A SCR  
One 1.1 kΩ Resistor, 1/10 W

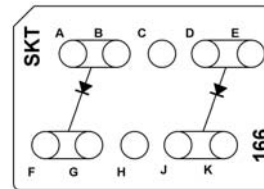

**CTJ420E166**  
Two ON Semiconductor  
MR756 Diodes

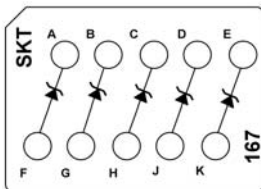

**CTJ420E167**  
Five 1N5351B Zener Diodes

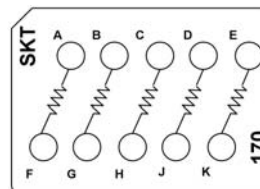

**CTJ420E170**  
Five 249 Ω Resistors, 1/4 W

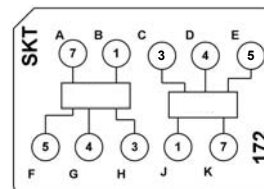

**CTJ420E172**  
Two TELEDYNE M93F-1 ISO Cubes

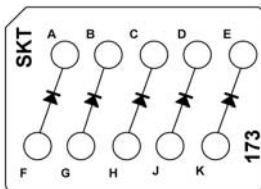

**CTJ420E173**  
Five JANTX 1N5418 Diodes

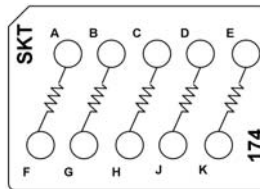

**CTJ420E174**  
Five 100 kΩ Resistors, 1/10 W

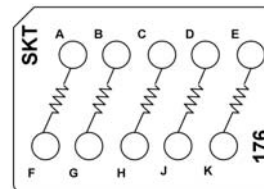

**CTJ420E176**  
Five 470 Ω Resistors, 1/2 W



CTJ4 Circuit Configurations

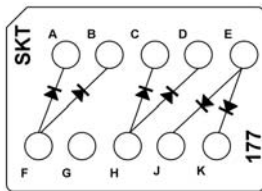

**CTJ420E177**  
Six JANTX 1N4454-1 Diodes

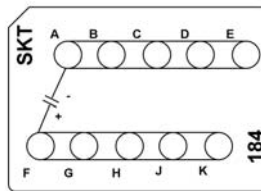

**CTJ420E184**  
One 1µF Capacitor, 50 VDC

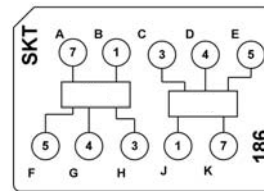

**CTJ420E186**  
Two TELEDYNE M92F-3 ISO Cubes

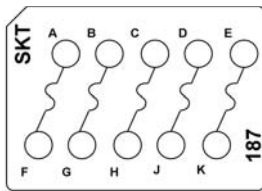

**CTJ420E187**  
Five 7 A Fuses, 125 V

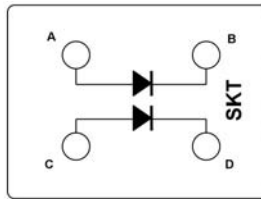

**CTJ420E189**  
Two JANTX 1N5618 Diodes

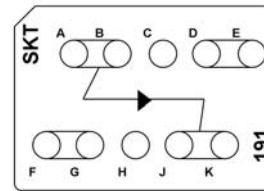

**CTJ420E191**  
One INTERSIL HA-5002/883 Current Buffer

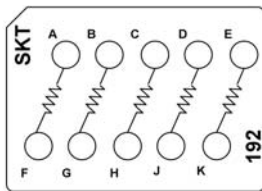

**CTJ420E192**  
Five 1 kΩ Resistors, 1/4 W

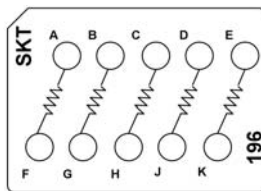

**CTJ420E196**  
Five 127 Ω Resistors, 1/8 W

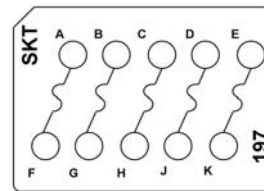

**CTJ420E197**  
Five 5 A Fuses, 125 V

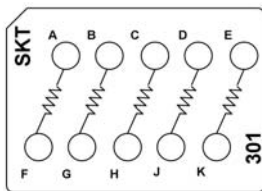

**CTJ420E301**  
Four 2.7 kΩ Resistors, 1/4 W  
One 56 Ω Resistor, 1/2 W

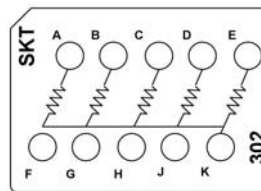

**CTJ420E302**  
Four 2.7 kΩ Resistors, 1/4 W  
One 3.9 kΩ Resistor, 1/4 W

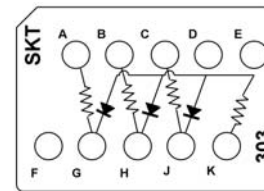

**CTJ420E303**  
One 2.7 kΩ Resistor, 1/4 W  
One 1.8 kΩ Resistor, 1/4 W  
One 5.1 kΩ Resistor, 1/4 W  
One 3.3 kΩ Resistor, 1/4 W  
Three JANTX 1N5711 Diodes

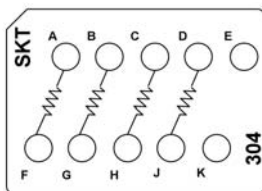

**CTJ420E304**  
Two 120 Ω Resistors, 1/2 W  
Two 2.7 kΩ Resistors, 1/4 W

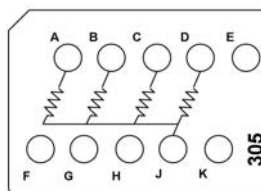

**CTJ420E305**  
Two 2.7 kΩ Resistors, 1/4 W  
Two 3.9 kΩ Resistors, 1/4 W

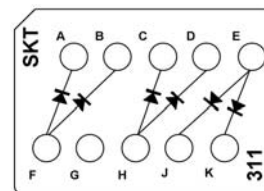

**CTJ420E311**  
Six JANTX 1N649-1 Diodes





CTJ4 Circuit Configurations

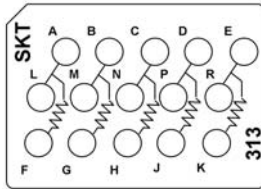

**CTJ420E313**  
Five 100 kΩ Resistors, 1/4 W

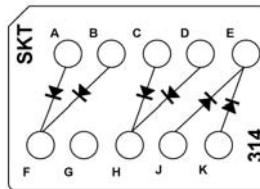

**CTJ420E314**  
Six 1N4007 Diodes

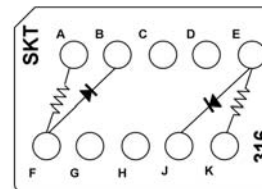

**CTJ420E316**  
Two 1 kΩ Resistors, 1/2 W  
Two 1N4007 Diodes

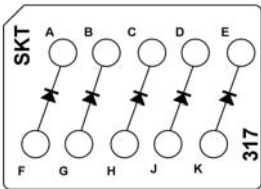

**CTJ420E317**  
Five 1N4007 Diodes

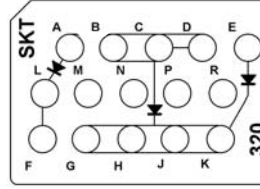

**CTJ420E320**  
Three JANTX 1N5550 Diodes

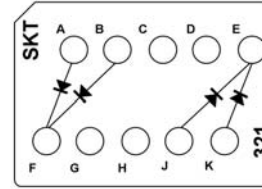

**CTJ420E321**  
Four JANS 1N5811 Diodes

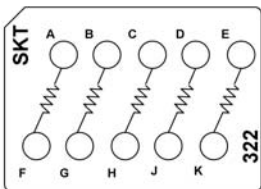

**CTJ420E322**  
Five 4.7 kΩ Resistors, 1/2 W

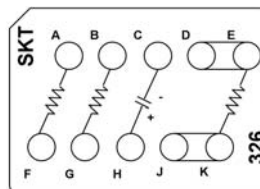

**CTJ420E326**  
One 100 Ω Resistor, 1/4 W  
One 300 Ω Resistor, 1/4 W  
One 573 Ω Resistor, 1/4 W  
One 10 μF Capacitor, 35 WVDC

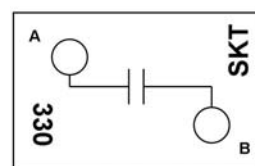

**CTJ420E330**  
One 1000 pF Capacitor, 100 VDC

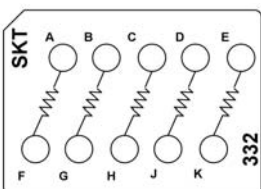

**CTJ420E332**  
Five 10 kΩ Resistor, 1/10 W

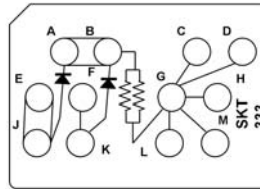

**CTJ420E333**  
Two 2 kΩ Resistors, 1/4 W  
Two JANTX 1N6677-1 Diodes

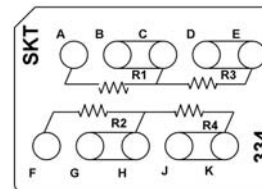

**CTJ420E334**  
Two 10 kΩ Resistors, 1/8 W  
Two 3 kΩ Resistors, 1/8 W

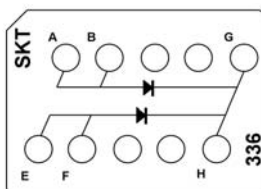

**CTJ420E336**  
Two 200 A Diodes

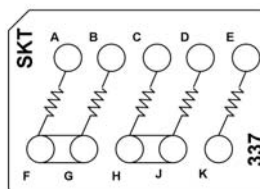

**CTJ420E337**  
One 1 kΩ Resistor, 1/8 W  
Three 10 kΩ Resistors, 1/8 W  
One 300 kΩ Resistor, 1/8 W

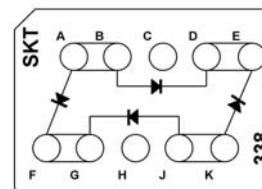

**CTJ420E338**  
Four JANTX 1N3613 Diodes



**CTJ4 Circuit Configurations**

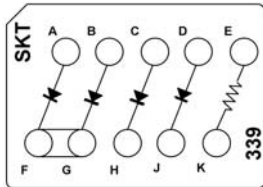

**CTJ420E339**  
One 100  $\Omega$  Resistor, 1/2 W  
Four JANTX 1N3613 Diodes

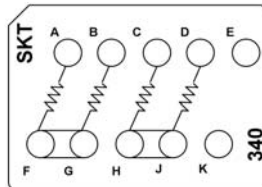

**CTJ420E340**  
Two 2.2 k $\Omega$  Resistors, 1/2 W  
Two 240 k $\Omega$  Resistors, 1/2 W

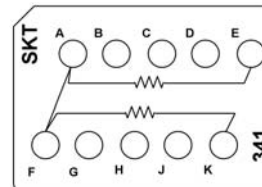

**CTJ420E341**  
Two 470 k $\Omega$  Resistors, 2 W

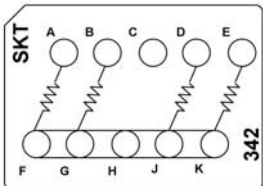

**CTJ420E342**  
Four 1.5 k $\Omega$  Resistors, 1 W

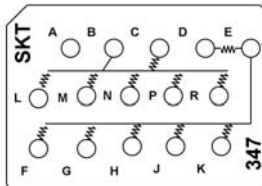

**CTJ420E347**  
Twelve 4.99 k $\Omega$  Resistors, 1/8 W



## DEUTSCH CTJ5 Series Board-Mount/Pluggable Modules

### CONVENIENT

- Mounts on pc board or flat flex cable
- Uses AS39029 socket contacts to accept wiring and connect through to straight solder pin contacts
- Uses a standard insertion/removal tool
- Light weight

### RUGGED

- Fluid resistant in most aerospace environments
- Available to operate in hydraulic fluid immersion

### EASY TO USE

- Straight solder pin contacts allow modules to be soldered to pc boards or plugged into specialized components
- All contacts are discrete, mainly used to take single leads from a PC board out to wire

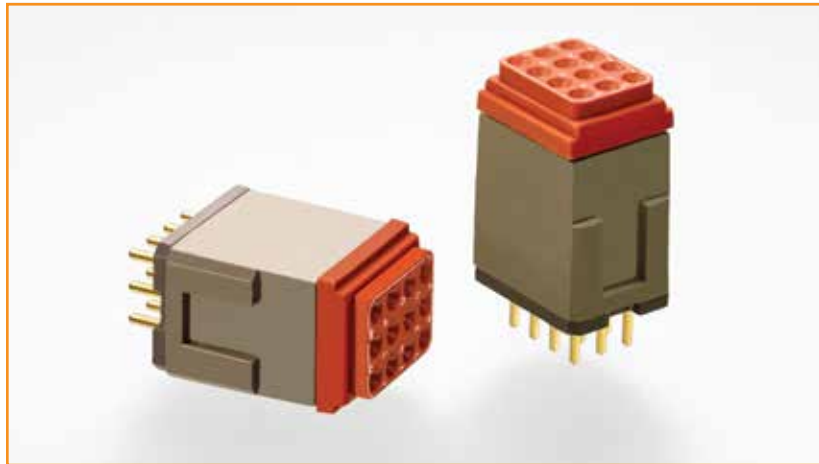

Fast, cost-effective termination of pc boards, flat flex cable, and electromechanical components.

### Specifications

**Dielectric Withstanding Voltage** (AS81714 paragraph 3.5.6):

At Sea Level: 1500 VAC<sub>rms</sub>  
At 110,000 Ft: 200 VAC<sub>rms</sub>

**Insulation Resistance** (AS81714 paragraph 3.5.11):

5000 MΩ min. at 25°C

**Operating Temperature:** -65°C to +200°C

**Physical Shock:** 78 g in each of the 3 mutually perpendicular planes

**Vibration:** Maintains continuity to minimize mechanical or physical damage during or after vibration following vibration levels

**Level 1—34 minutes per axis**

20-90 Hz at 6 dB/oct. rise

90-300 Hz at 1.0 g<sup>2</sup>/Hz

300-2000 Hz at 6 dB/oct. fall

**Level 2—14 minutes per axis**

20-40 Hz at 6 dB/oct. rise

40-350 Hz at 0.5 g<sup>2</sup>/Hz

350-2000 Hz at 6 dB/oct. fall

No discontinuities greater than 1 microsecond

**Corrosion:** 48 hours of salt spray

**Magnetic Permeability:** 2.0 μ max.

**Fluid Resistance:**

MIL-PRF-5606: Hydraulic fluid

MIL-DTL-83133: JP-8 aviation fuel

MIL-PRF-7808: Lubricating oil

MIL-PRF-23699: Lubricating oil

MIL-A-8243: Deicing/defrosting fluid

MIL-C-25769: Aircraft cleaning compound

MIL-PRF-87937: Aircraft cleaning compound

MIL-G-3056: Gasoline



**Materials**

**Housing:** Composite

**Bus Bar/Pins:** Copper alloy, plated gold

**Pin Contacts:** Gold over copper

**Sealing Grommet:** Elastomer, fluid resistant and environmentally sealed

**Contact Resistance (at 25°C)**  
*Meets AS39029 paragraph 3.5.4*

| Wire Size | Test Current | Voltage Drop |
|-----------|--------------|--------------|
| 22 AWG    | 5 A          | 110 mV       |
| 20 AWG    | 7.5 A        | 83 mV        |
| 16 AWG    | 13 A         | 74 mV        |

**Usable Wire Size**  
*Meets AS39029 paragraph 3.4.2*

| Contact | Wire Range (AWG) | Current Rating |
|---------|------------------|----------------|
| Size 22 | 26-22            | 5 A            |
| Size 20 | 24-20            | 7.5 A          |
| Size 16 | 16-20            | 13 A           |

**Grommet Sealing Range**

| Contact Size | Wire OD |       |
|--------------|---------|-------|
|              | Min.    | Max.  |
| 22           | 0.030   | 0.060 |
| 20           | 0.040   | 0.083 |
| 16           | 0.065   | 0.109 |

**Modules**

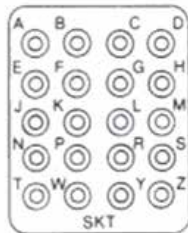

**Size 22**  
20 Size 22 Contacts

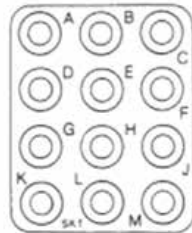

**Size 20**  
12 Size 20 Contacts

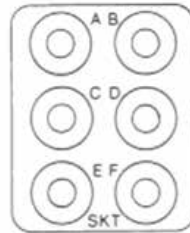

**Size 16**  
6 Size 16 Contacts

**Pin Arrangements**

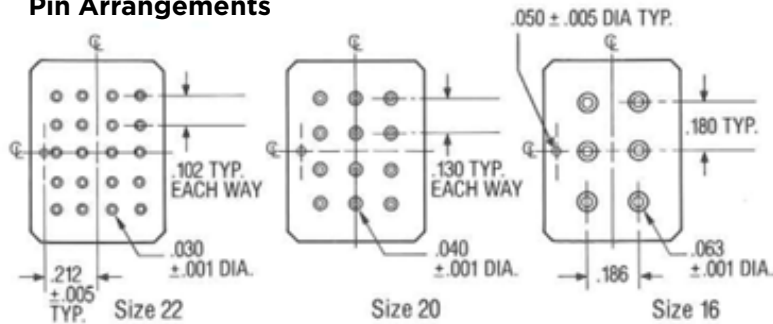



**Outline Dimensions**

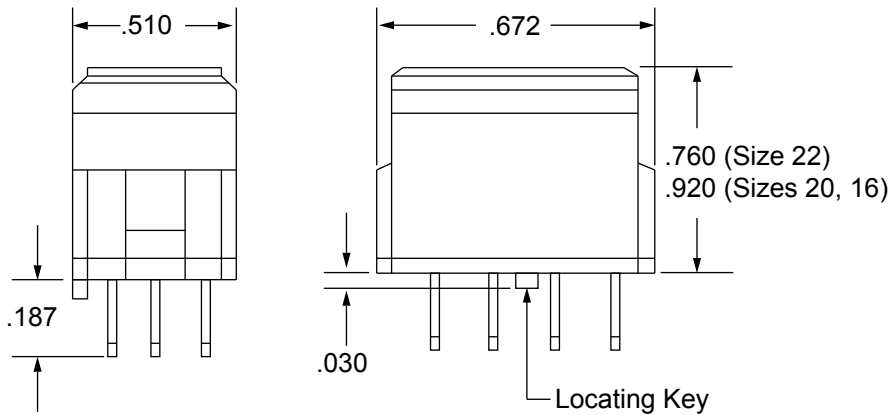

**Part Numbering System**

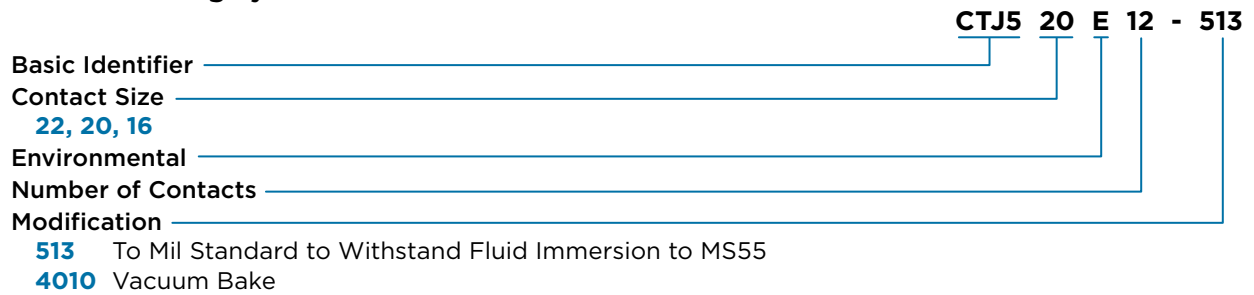

**Ordering Information**

| Module  | Part No.      |
|---------|---------------|
| Size 22 | CTJ522E20-xxx |
| Size 20 | CTJ520E12-xxx |
| Size 16 | CTJ516E6-xxx  |

xxx = modification code.



## DEUTSCH CTJ6 and CTJ9 Series Plug and Receptacle Connectors

### SAVE SPACE AND WEIGHT

- Small, lightweight modules
- Flange mounting or in-line mounting for simultaneous connect/disconnect of many wires

### VERSATILE

- Flange or in-line mountable
- Backpack configurations available for receptacle connectors
- Available with optional strain relief
- PCB tail contacts or with crimp backpack

### RELIABLE

- Cork in bottle interfacial seal between the mating halves
- Environmentally resistant

### EASY MATING/UNMATING

- Audible click indicates proper mating
- Simple tool allows unmating



Small, lightweight modules designed for flange mounting or in-line mounting for simultaneous connect/disconnect of many wires.

### Specifications

**Dielectric Withstanding Voltage** (AS81714 paragraph 3.5.6):

- At Sea Level: 1500 VAC<sub>rms</sub>
- At 100,000 Ft: 200 VAC<sub>rms</sub>

**Insulation Resistance** (AS81714 paragraph 3.5.11): 5000 M $\Omega$  min. at 25°C

**Operating Temperature:** -65°C to +200°C

**Thermal Shock** (AS81714 paragraph 3.5.5): After cycling the modules between -55°C and +200°C, they will meet all applicable electrical and mechanical requirements

**Vibration:** Maintains continuity to minimize mechanical or physical damage during or after vibration following vibration levels

**Level 1—34 minutes per axis**

- 20-90 Hz at 6 dB/oct. rise
- 90-300 Hz at 1.0 g<sup>2</sup>/Hz
- 300-2000 Hz at 6 dB/oct. fall

**Level 2—14 minutes per axis**

- 20-40 Hz at 6 dB/oct. rise
- 40-350 Hz at 0.5 g<sup>2</sup>/Hz
- 350-2000 Hz at 6 dB/oct. fall
- No discontinuities greater than 1 microsecond

**Corrosion:** No decrease in performance or exposure of base metal up to 48 hours of salt spray

**Fluid Resistance:**

- MIL-PRF-5606: Hydraulic fluid
- MIL-DTL-83133: JP-8 aviation fuel
- MIL-PRF-7808: Lubricating oil
- MIL-PRF-23699: Lubricating oil
- MIL-A-8243: Deicing/defrosting fluid
- MIL-C-25769: Aircraft cleaning compound
- MIL-PRF-87937: Aircraft cleaning compound
- MIL-G-3056: Gasoline



**Materials**

**Housing:** Composite

**Bus Bar/Pins:** Copper alloy, plated gold

**Pin Contacts:** Gold over copper

**Sealing Grommet:** Elastomer, fluid resistant and environmentally sealed

**Strain Relief:** Brass, nickel plated

**Usable Wire Size**

*Meets AS39029 paragraph 3.4.2*

| Contact | Wire Range (AWG) | Current Rating |
|---------|------------------|----------------|
| Size 20 | 24-20            | 7.5 A          |
| Size 12 | 14-12            | 3 A            |

**Layout Arrangements**

*(Viewed from grommet side of plug module)*

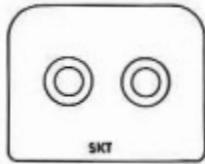

**Layout 02**  
 2 Size 12 Contacts

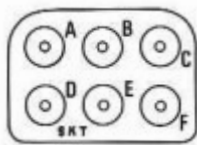

**Layout 06**  
 6 Size 20 Contacts

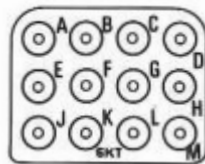

**Layout 12**  
 12 Size 20 Contacts

**CTJ9 Receptacle Configurations**

*(Shown with rear environmental assembly)*

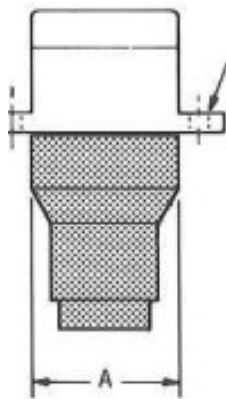

FLANGE SIZE  
 SAME AS ON  
 RECEPTACLE  
 (BELOW)

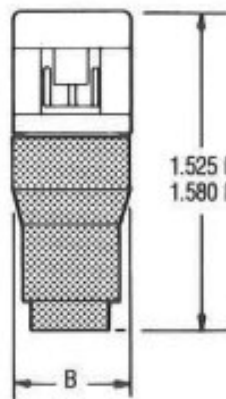

1.525 MAX (Layout 06 & 12)  
 1.580 MAX (Layout 02)



**Part Numbering System**

**CTJ 6 20 E 02 N - 513**

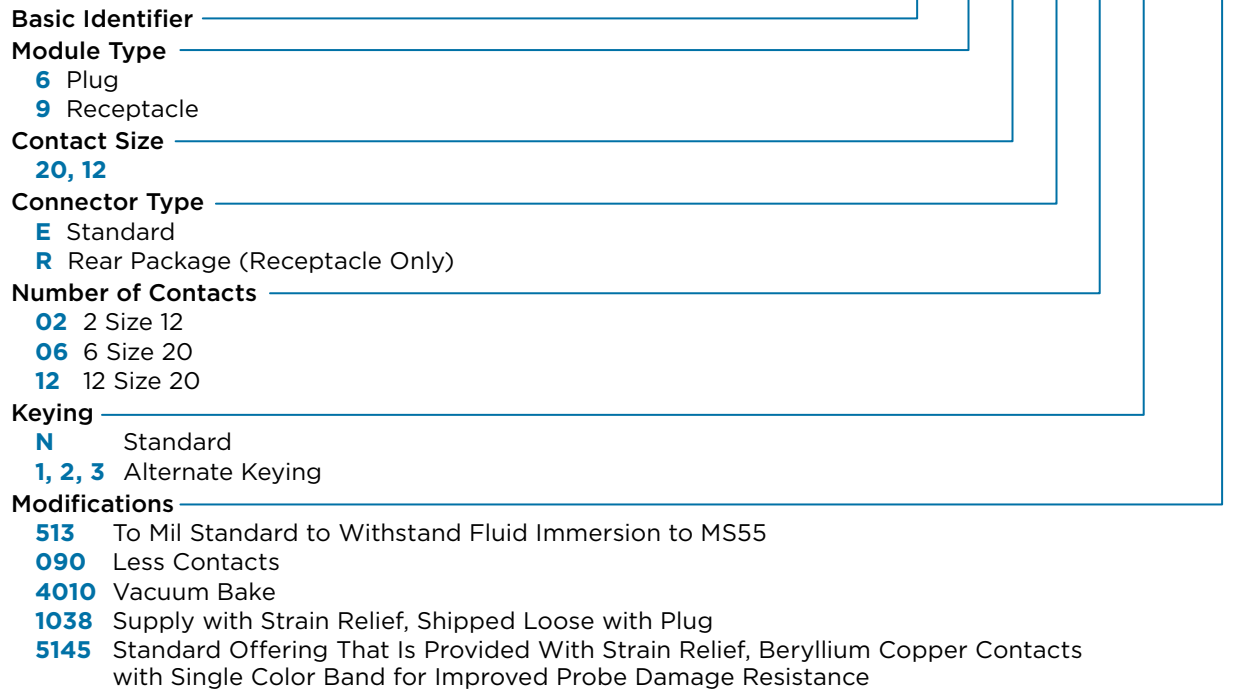

**CTJ9 Receptacle Outline and Mounting Dimensions**

Flange Mount Receptacle In-Line Receptacle  
Order Part No. 65002\*\*\* for standard extended pins  
Order Part No. 65003\*\*\* for rear environmental assembly

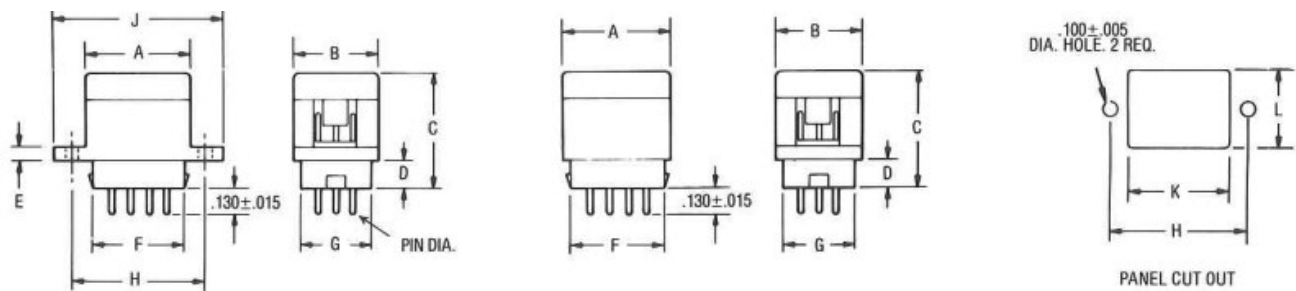

| Layout | A     | B     | C     | D     | E     | F     | G     | H     | J     | K     | L     |
|--------|-------|-------|-------|-------|-------|-------|-------|-------|-------|-------|-------|
| 02     | 0.770 | 0.620 | 0.750 | 0.200 | 0.100 | 0.670 | 0.510 | 1.000 | 1.300 | 0.750 | 0.530 |
| 06     | 0.650 | 0.470 | 0.750 | 0.200 | 0.100 | 0.550 | 0.380 | 1.000 | 1.180 | 0.600 | 0.380 |
| 12     | 0.770 | 0.620 | 0.750 | 0.200 | 0.100 | 0.670 | 0.510 | 1.000 | 1.300 | 0.750 | 0.530 |





### CTJ6 Plug Outline Dimensions

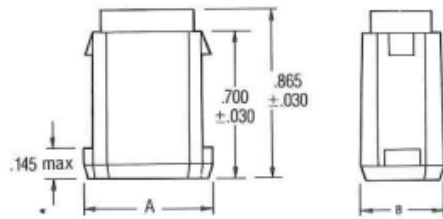

| Layout | A     | B     | Part No.  |
|--------|-------|-------|-----------|
| 02     | 0.652 | 0.510 | CTJ612E02 |
| 06     | 0.530 | 0.360 | CTJ620E06 |
| 12     | 0.652 | 0.510 | CTJ620E12 |

### Clocking Options

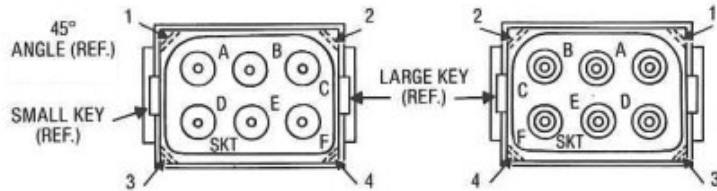

| Keying Position | 45° Angle Location |
|-----------------|--------------------|
| N               | 1, 2               |
| 1               | 3, 4               |
| 2               | 1, 3               |
| 3               | 2, 4               |

### Strain Relief

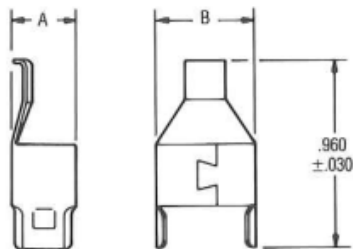

| Used with Layout | A     | B     | Part No.       |
|------------------|-------|-------|----------------|
| 06               | 0.320 | 0.490 | 1629-011-06117 |
| 12               | 0.470 | 0.630 | 1629-011-12117 |

### CTJ6/CTJ9 Mating Procedure

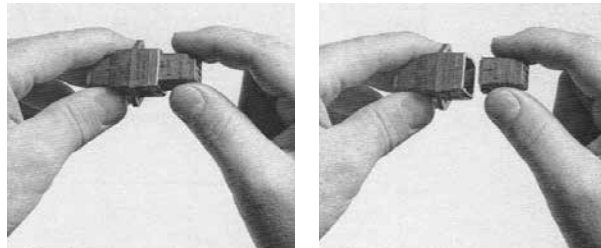

**Step 1.** With the plug's engaging surface facing the receptacle's mating face and the angled keying surfaces aligned, insert the plug into the receptacle.

**Step 2.** Press the plug and receptacle firmly together until you hear an audible click that indicates the plug is fully seated and locked in position.

### CTJ6/CTJ9 Unmating Procedure

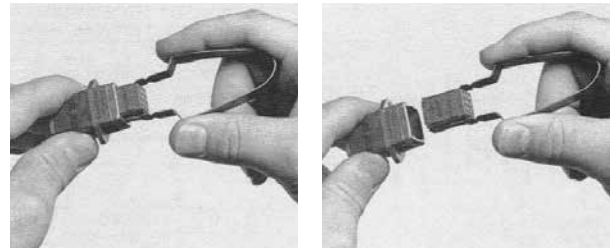

**Step 1.** Place extraction tool CTJ-R06 over the plug module and insert it into the slots on both sides of the receptacle. Push the tool in until the module's locking fingers disengage.

**Step 2.** Pressing the legs of the tool to hold the module tight, pull back to remove the plug module.



## DEUTSCH CTJ7 and CTG Series Grounding Modules and Junctions

### CONVENIENT

- Small rugged devices
- Environmentally sealed
- Simple assembly

### FLEXIBLE

- Stud and flange mounting
- Threaded stud can replace the screw terminals

### RUGGED ONE-PIECE CONSTRUCTION

- Resistant to shock and vibration
- Light weight
- Dissipates heat well



**CTJ7 grounding modules** for multiwire grounding applications that need a small, rugged device that also offers sealing and assembly ease.

**CTG grounding junctions** provide a simple method of terminating a wire to ground. Wires with crimp type contacts inserted into the grounding junctions can then be attached to any grounding surface. Junctions are available for size 22, 20, 16, and 12 contacts.

### Specifications

**Dielectric Withstanding Voltage** (AS81714 paragraph 3.5.6):

At Sea Level: 1500 VAC<sub>rms</sub>

At 110,000 Ft: 200 VAC<sub>rms</sub>

**Insulation Resistance** (AS81714 paragraph 3.5.11): 5000 MΩ min. at 25°C

**Operating Temperature:** -65°C to +200°C

**Physical Shock:** 78 g in each of the 3 mutually perpendicular planes

**Thermal Shock** (AS81714 paragraph 3.5.5): After cycling the module between -55°C and +200°C, it will meet all applicable electrical and mechanical requirements

**Vibration:** Maintains continuity to minimize mechanical or physical damage during or after vibration following vibration levels

**Level 1—34 minutes per axis**

20-90 Hz at 6 dB/oct. rise

90-300 Hz at 1.0 g<sup>2</sup>/Hz

300-2000 Hz at 6 dB/oct. fall

**Level 2—14 minutes per axis**

20-40 Hz at 6 dB/oct. rise

40-350 Hz at 0.5 g<sup>2</sup>/Hz

350-2000 Hz at 6 dB/oct. fall

No discontinuities greater than 1 microsecond



**Corrosion:** 48 hours of salt spray

**Magnetic Permeability:** 2.0  $\mu$  max.

**Fluid Resistance:**

- MIL-PRF-5606: Hydraulic fluid
- MIL-DTL-83133: JP-8 aviation fuel
- MIL-PRF-7808: Lubricating oil
- MIL-PRF-23699: Lubricating oil
- MIL-A-8243: Deicing/defrosting fluid
- MIL-C-25769: Aircraft cleaning compound
- MIL-PRF-87937: Aircraft cleaning compound
- MIL-G-3056: Gasoline

**Materials**

**Housing:** Composite

**Bus Bar/Pins:** Copper alloy, plated gold

**Pin Contacts:** Gold over copper

**Sealing Grommet:** Elastomer, fluid resistant and environmentally sealed

**Contact Resistance (at 25°C)**

*Meets AS39029 paragraph 3.5.4*

| Wire Size | Test Current | Voltage Drop |
|-----------|--------------|--------------|
| 22 AWG    | 5 A          | 73 mV        |
| 20 AWG    | 7.5 A        | 55 mV        |
| 16 AWG    | 13 A         | 50 mV        |
| 12 AWG    | 23 A         | 42 mV        |

**Usable Wire Size**

*Meets AS39029 paragraph 3.4.2*

| Contact | Wire Range (AWG) | Current Rating |
|---------|------------------|----------------|
| Size 22 | 26-22            | 5 A            |
| Size 20 | 24-20            | 7.5 A          |
| Size 16 | 16-20            | 13 A           |
| Size 12 | 14-12            | 3 A            |

**Grommet Sealing Range**

| Contact Size | Wire OD |       |
|--------------|---------|-------|
|              | Min.    | Max.  |
| 22           | 0.030   | 0.060 |
| 20           | 0.040   | 0.083 |
| 16           | 0.065   | 0.109 |
| 12           | 0.097   | 0.142 |

**CTJ7 Modules**



**Size 22**  
**01C Bussing Code**  
20 Size 22 Contacts



**Size 20**  
**01B Bussing Code**  
12 Size 20 Contacts



**Size 16**  
**01D Bussing Code**  
6 Size 16 Contacts

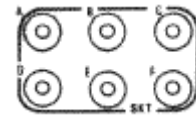

**Size 12**  
**01E Bussing Code**  
6 Size 12 Contacts

**CTJ7 Module Outline Dimensions**

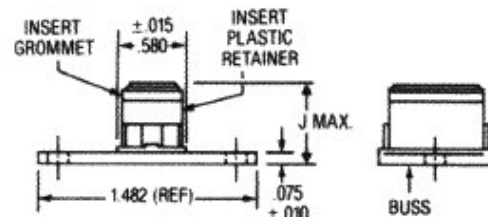
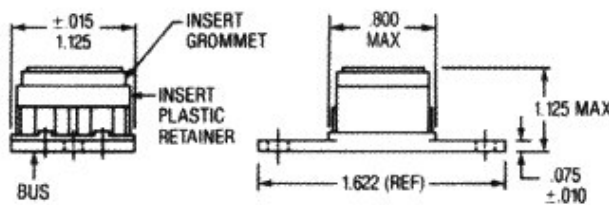
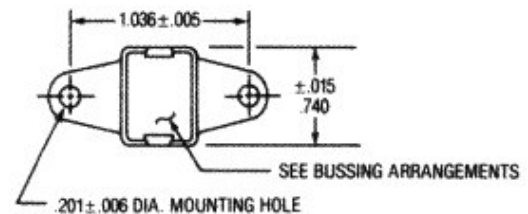
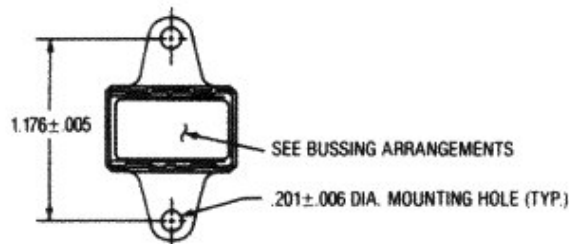

**Type K: Flange Mount**

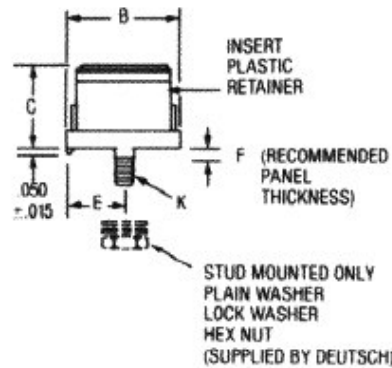
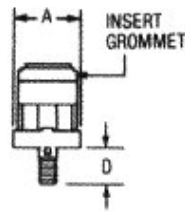
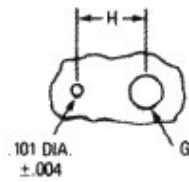

Type E: Stud Mount

### Part Numbering System

**CTJ7 22 K 01C - 513**

Basic Identifier

Module Size

- 22** Size 22 Contact
- 20** Size 20 Contacts
- 16** Size 16 Contacts
- 12** Size 12 Contacts

Flange Mounting Style

- K** Flange Mount
- E** Stud Mount (Not available for size 12)

Bus Arrangement

- 01C** 20 Size 22 Contacts Bussed
- 01B** 12 Size 20 Contacts Bussed
- 01D** 6 Size 16 Contacts Bussed
- 01E** 6 Size 12 Contacts Bussed

Modifications

- 513** To Mil Standard to Withstand Fluid Immersion to MS55
- 090** Less Contacts
- 6144** Replace Standard Hardware with MS21042I3 Self-Locking Nut and MS55 Resilient Material; Replace Standard Contacts with High-Reliability Contacts
- 6148** MS55 Resilient Material, Omit Contacts, Sealing Plugs, and Insertion/Removal Tool
- 7067** Gold-Over-Nickel Plating, MVFS Insert Material, Add Washer, Rotate Insert Marking
- 4010** Vacuum Bake

### CTG Junction Outline Dimensions

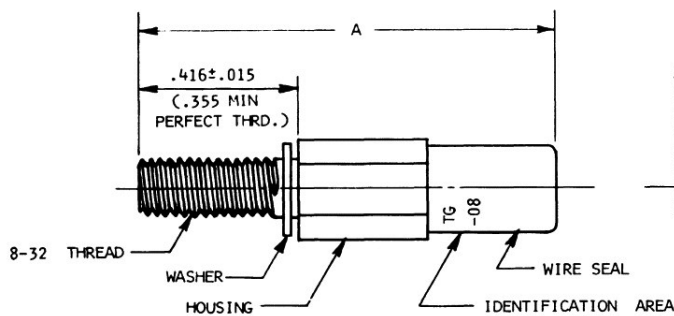

| Contacts Size | A                | B               | Part No.  |
|---------------|------------------|-----------------|-----------|
| 22            | 1.316<br>(33.43) | 0.188<br>(4.78) | CTG-22-08 |
| 20            | 1.240<br>(31.50) | 0.188<br>(4.78) | CTG-20-08 |
| 16            | 1.246<br>(31.65) | 0.250<br>(6.35) | CTG-16-08 |
| 12            | 1.370<br>(34.80) | 0.313<br>(7.95) | CTG-12-08 |



## DEUTSCH CTL, CTM, and CTN Series In-Line Junctions

### VERSATILE

- Options to connect up to 4 wires in-line and bussed configurations
- Houses and seals individual components
- Replacement for “Y” splices and terminal strips
- Special configurations and designs available

### RUGGED

- Resistant to shock and vibration, per Mil AS39029, paragraph 3.5.9
- Extreme temperature range: -55°C to +200°C
- Resistant to harsh fluids, per Mil AS-81714

### EASY TO USE

- In-line mountable
- Uses AS39029 crimp contacts



**CTL series in-line junctions** connect two wires in-line using crimp-type contacts. The junctions can then be placed in a wire bundle without being mounted.

**CTM series multi-junctions** connect and bus four wires. They can be used to replace “Y” splices and terminal strips.

**CTN Series electronic multi-junctions** are in-line devices that houses and shields passive or active components, including fuses, resistors, diodes, capacitors, or integrated circuits.

#### Dielectric Withstanding Voltage (AS81714):

- At Sea Level: 1500 VAC<sub>rms</sub>
- At 110,000 Ft: 200 VAC<sub>rms</sub>

**Operating Temperature:** -55°C to +200°C

**Physical Shock** (AS39029, paragraph 3.5.9): Items shall not be damaged, there shall be no loosening of parts due to shock, and no interruption of electrical continuity longer than one microsecond during exposure to mechanical shock.

#### Fluid Resistance:

- MIL-PRF-5606: Hydraulic fluid
- MIL-DTL-83133: JP-8 aviation fuel
- MIL-PRF-7808: Lubricating oil
- MIL-PRF-23699: Lubricating oil
- MIL-A-8243: Deicing/defrosting fluid
- MIL-C-25769: Aircraft cleaning compound
- MIL-PRF-87937: Aircraft cleaning compound
- MIL-G-3056: Gasoline

#### Materials

**Housing:** Composite

**Bus Bar/Pins:** Copper alloy, plated gold

**Pin Contacts:** Gold over copper

**Sealing Grommet:** Elastomer, fluid resistant and environmentally sealed



**Usable Wire Size**

Meets AS39029 paragraph 3.4.2

| Contact | Wire Range (AWG) | Current Rating |
|---------|------------------|----------------|
| Size 22 | 26-22            | 5 A            |
| Size 20 | 24-20            | 7.5 A          |
| Size 16 | 16-20            | 13 A           |
| Size 12 | 14-12            | 3 A            |

**Grommet Sealing Range**

| Contact Size | Wire OD |       |
|--------------|---------|-------|
|              | Min.    | Max.  |
| 22           | 0.030   | 0.060 |
| 20           | 0.040   | 0.083 |
| 16           | 0.065   | 0.109 |

**CTL Outline Dimensions**

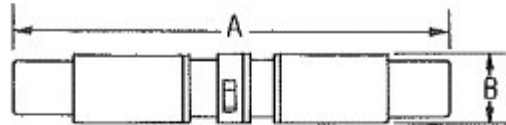

SIZE 12, 16, 20 & 22

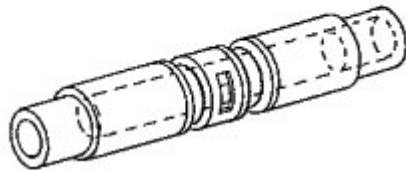

| Part No. | Size | A Max. | B $\phi$ .030 |
|----------|------|--------|---------------|
| CTL-22   | 22   | 1.280  | 0.200         |
| CTL-20   | 20   | 1.452  | 0.260         |
| CTL-16   | 16   | 1.400  | 0.300         |
| CTL-12   | 12   | 1.680  | 0.360         |

**Part Numbering System**

**CTL - 22 - 513**

Basic Identifier

Contact Size

Modifications

**513** To Mil Standard to Withstand Fluid Immersion to MS55

**090** Less Contacts

**6148** MS55 Resilient Material, Omit Contacts, Sealing Plugs, and Insertion/Removal Tool

**4010** Vacuum Bake

**CTM Outline Dimensions**

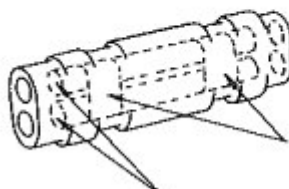
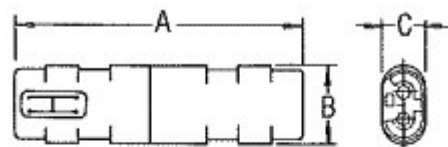

| Part No. | Size | A $\phi$ .060 | B $\phi$ .030 | C $\phi$ .030 |
|----------|------|---------------|---------------|---------------|
| CTM 22   | 22   | 1.262         | 0.354         | 0.210         |
| CTM 20   | 20   | 1.368         | 0.451         | 0.241         |
| CTM 16   | 16   | 1.368         | 0.518         | 0.274         |
| CTM 12   | 12   | 1.644         | 0.644         | 0.337         |



**Part Numbering System**

**CTM - 22 - 513**



- 513** To Mil Standard to Withstand Fluid Immersion to MS55
- 090** Less Contacts
- 4010** Vacuum Bake

**CTN Layout Arrangements**

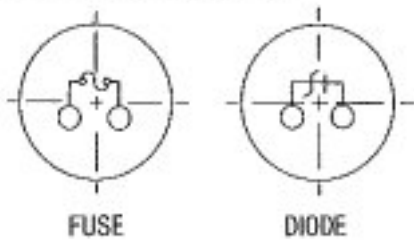

**CTN Outline Dimensions**

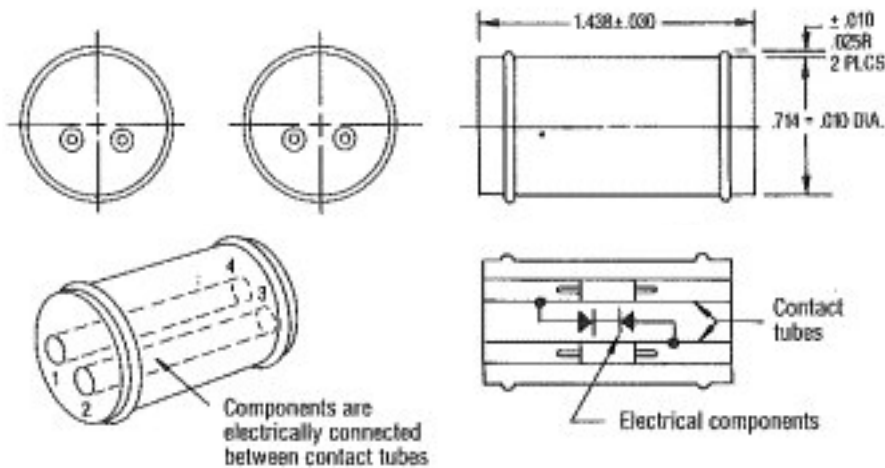

**Part Numbering System**

**CTN 20 D XXX - 513**

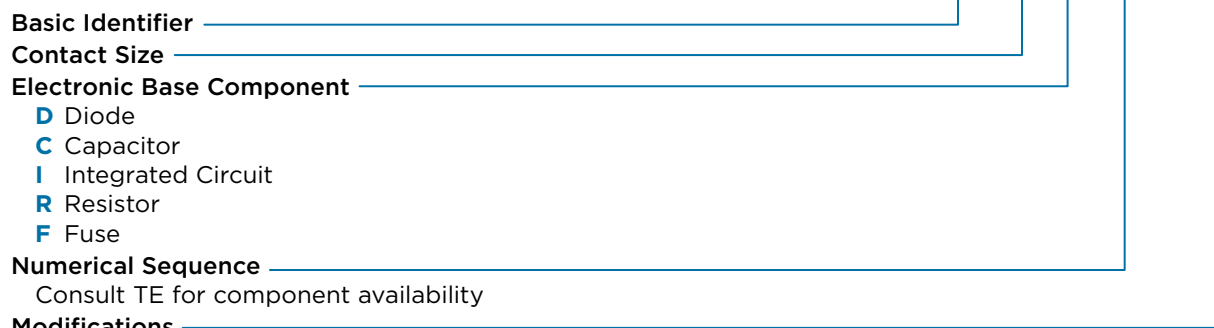

- D** Diode
- C** Capacitor
- I** Integrated Circuit
- R** Resistor
- F** Fuse

Consult TE for component availability

- 513** To Mil Standard to Withstand Fluid Immersion to MS55
- 090** Less Contacts
- 6148** MS55 Resilient Material, Omit Contacts, Sealing Plugs, and Insertion/Removal Tool
- 4010** Vacuum Bake



## DEUTSCH Composite In-line Junctions

### RUGGED

- Rugged composite housing
- Fluid resistant: hydraulic fluid, jet fuel, and other fluids common in aerospace and defense applications
- Environmentally sealed
- No exposed discrete components

### EASY TO USE

- Reliable and quick termination
- No mounting required
- Light weight

### CONVENIENT

- Field serviceable AS39029 socket contacts
- Accommodates a wide range of common gauge wire, from 22 to 12 AWG
- Hand crimp socket contacts

### VERSATILE

- Design options for discrete components available



Designed to AS81714 requirements, DEUTSCH in-line termination junctions are composite versions of the CTL, CTM, and CTN series.

**Dielectric Withstanding Voltage** (AS81714 paragraph 3.5.6):

- At Sea Level: 1500 VAC<sub>rms</sub>
- At 100,000 Ft: 200 VAC<sub>rms</sub>

**Operating Temperature:** -65°C to +200°C

**Insulation Resistance** (AS81714 paragraph 3.5.11): 5000 MΩ min. at 25°C

**Electrical Continuity:**

- Shock Exposure: <1 μs @ 300 g sine/2 3 ms
- Vibration: <1 μs @ 30 g peak

### Materials

**Housing:** Composite

**Bus Bar/Pins:** Copper alloy, plated gold

**Pin Contacts:** Copper, plated gold

**Sealing Grommet:** Elastomer, fluid resistant and environmentally sealed





**Usable Wire Size**

Meets AS39029 paragraph 3.4.2

| Contact | Wire Range (AWG) | Current Rating |
|---------|------------------|----------------|
| Size 22 | 26-22            | 5 A            |
| Size 20 | 24-20            | 7.5 A          |
| Size 16 | 16-20            | 13 A           |
| Size 12 | 14-12            | 3 A            |

**Grommet Sealing Range**

| Contact Size | Wire OD |       |
|--------------|---------|-------|
|              | Min.    | Max.  |
| 22           | 0.030   | 0.060 |
| 20           | 0.040   | 0.083 |
| 16           | 0.065   | 0.109 |

**Single In-line Junction**

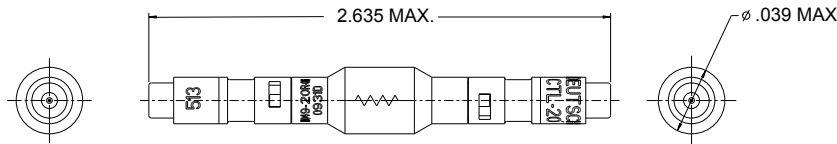

**Single In-Line Junction**

65049-20R-XXX (R = resistor)

| XXX | Component Value             | Manufacturer PN              |
|-----|-----------------------------|------------------------------|
| 004 | 5.1 K $\Omega$ , 1/4 W, 2%  | RLR07C5101GS                 |
| 009 | 510 $\Omega$ , 1/4 W, 5%    | RCR07G511JS                  |
| 010 | 390 $\Omega$ , 1/4 W, 5%    | RCR07G391JS                  |
| 011 | 150 K $\Omega$ , 1/4 W, 5%  | RLR07C1500JS                 |
| 016 | 1540 $\Omega$ , 1/4 W, 1%   | RLR07C1541FS                 |
| 017 | 100 K $\Omega$ , 1/8 W, 1%  | RNR55C1003F* (* = R or S)    |
| 018 | 10 K $\Omega$ , 1/4 W, 1%   | RLR07C1002FS                 |
| 019 | 2.7 K $\Omega$ , 1/4 W, 2%  | RLR07C2701GS                 |
| 022 | 430 K $\Omega$ , 1 W, 1%    | RWR81S4300FR                 |
| 024 | 1 K $\Omega$ , 1/2 W, 1%    | PPC1.00KXCT-ND               |
| 025 | 1.25 K $\Omega$ , 1/4 W, 1% | RNF55-125 $\mu$ , -1%-5PPM-1 |
| 026 | 100 K $\Omega$ , 1/4 W, 1%  | RLR05C3161FS                 |

65049-20D-XXX (D = diode)

| XXX | Component Value | Manufacturer PN |
|-----|-----------------|-----------------|
| 016 | 600 Vrms @ 1 A  | JANTX 1N5619    |
| 018 | 700 Vrms @ 3 A  | JANTX 1N5554    |

65049-20F-XXX (F = fuse)

| XXX | Component Value | Manufacturer PN       |
|-----|-----------------|-----------------------|
| 004 | 125 V @ 0.5 A   | FM08A (TINITRON FUSE) |

Please ask your salesperson for customized specifications (based on discrete passive requirement part number)



## Dual In-line Junctions

Basic Identifier ..... **65053-201**

All contacts provided are size 20 sockets  
Mil Spec M39029/22-192.

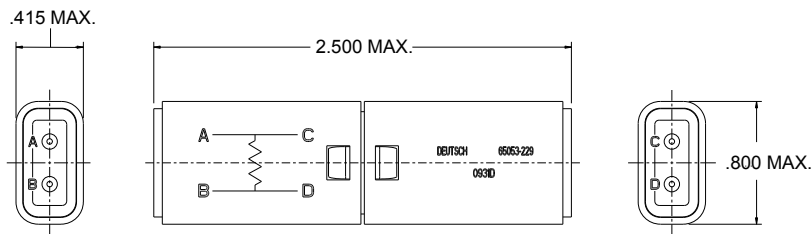

### Dual In-Line Junction 65053-XXX

| XXX | Component Value       | Manufacturer PN            |
|-----|-----------------------|----------------------------|
| 201 | 36 Vwm @ 23 A, Bi-dir | Diode = 1N6388             |
| 202 | 420 Vrms @ 3 A        | Diode = 1N5406             |
| 203 | 420 Vrms @ 3 A        | Diode = dual 1N5406        |
| 204 | 14 Vz @ 6.7 Azs       | Diode = 1N5351B            |
| 205 | 125 V, 0.5 A          | Fuse = dual FM08A125V1/2A  |
| 208 | 700 Vrms @ 10 A peak  | Diode = dual 1N4007        |
| 214 | 600 Vrrm @ 1 A        | Diode = dual 1N5618        |
| 216 | 120 Ω, 1/2 W          | Resistor = RCR20G121JS     |
| 219 | 125 V, 2 A            | Fuse = FM08A125V1/2A       |
| 220 | 125 V, 7 A            | Fuse = PICO II SLO-BLO 473 |
| 224 | 125 V, 1 A            | Fuse = PICO II SLO-BLO 473 |
| 226 | 1Ω, 1 W               | Resistor = OHMITE WHB1ROFE |

Please ask your salesperson for customized specifications  
(based on discrete passive requirement part number)



## DEUTSCH Adapter Junctions

### CONVENIENT

- Easily convert devices with screw terminals to use DEUTSCH contacts

### FLEXIBLE

- Two thread sizes
- Environmental and nonenvironmental versions

### RELIABLE

- Low-cost contact insertion/removal tool protects converted device by breaking before it can damage junction or device



Adapter junctions provide a quick and easy way to convert electrical components with screw terminals to the CTJ system. The junction attaches to and becomes part of the device to be converted. The adapter junctions are available in two thread sizes (8/32 and 6/32) and in environmental and nonenvironmental versions.

The adapter junctions meet all applicable requirements of MIL-C-26482.



### JTA Series Nonenvironmental Adapter Junctions

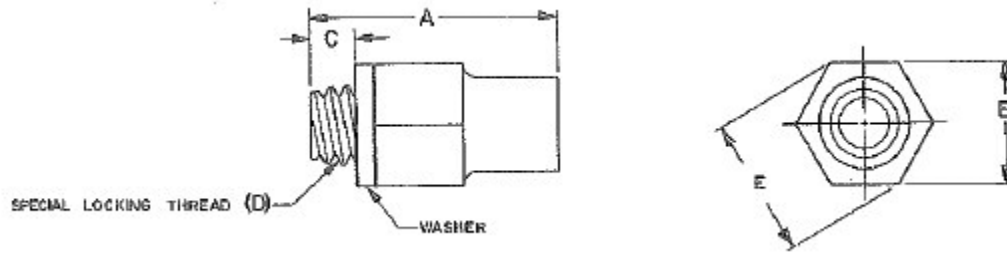

| Contact Size | Part No.    |             | Dimensions |         |         |         | Weight (Lb., Approx.) |
|--------------|-------------|-------------|------------|---------|---------|---------|-----------------------|
|              | 8-32 Thread | 6-32 Thread | A 6.020    | B 6.020 | C 6.020 | E (Ref) |                       |
| 22           | JTA-22-01   | JTA-22-02   | 0.553      | 0.187   | 0.096   | 0.216   | 0.0036                |
| 20           | JTA-20-01   | JTA-20-02   | 0.551      | 0.187   | 0.096   | 0.216   | 0.0036                |
| 16           | JTA-16-01   | JTA-16-02   | 0.561      | 0.250   | 0.096   | 0.289   | 0.0059                |
| 12           | JTA-12-01   | —           | 0.605      | 0.312   | 0.096   | 0.360   | 0.0099                |

### JTE Series Environmental Adapter Junctions

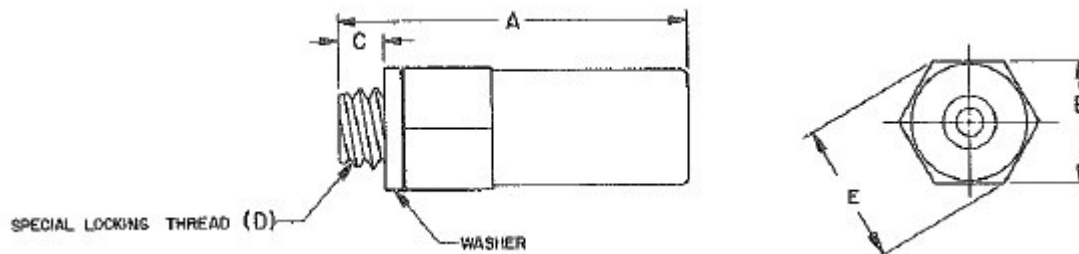

| Contact Size | Part No.    |             | Dimensions |         |         |         | Weight (Lb., Approx.) |
|--------------|-------------|-------------|------------|---------|---------|---------|-----------------------|
|              | 8-32 Thread | 6-32 Thread | A 6.020    | B 6.020 | C 6.020 | E (Ref) |                       |
| 22           | JTE-22-01   | JTE-22-02   | 0.838      | 0.187   | 0.096   | 0.216   | 0.0039                |
| 20           | JTE-20-01   | JTE-20-02   | 0.745      | 0.187   | 0.096   | 0.216   | 0.0039                |
| 16           | JTE-16-01   | JTE-16-02   | 0.773      | 0.250   | 0.096   | 0.289   | 0.0063                |
| 12           | JTE-12-01   | —           | 0.842      | 0.312   | 0.096   | 0.360   | 0.0106                |



## DEUTSCH CTJ2 Series Metallic Single-Module Rails

### VERSATILE

- Designed to hold up to 50 variations
- Elongated mounting holes for easy installation
- Available in sizes ranging from 2" to 40"

### LIGHT WEIGHT

- Extruded aluminum alloy rail
- Stainless steel metal clip



CTJ2 metallic rails are aluminum alloy and designed to hold one single module or two half-size modules.

### Outline Dimensions

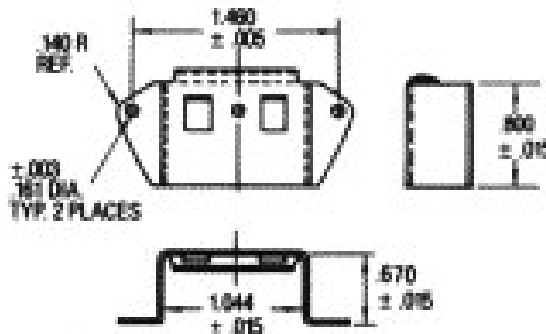

### Part Numbering System

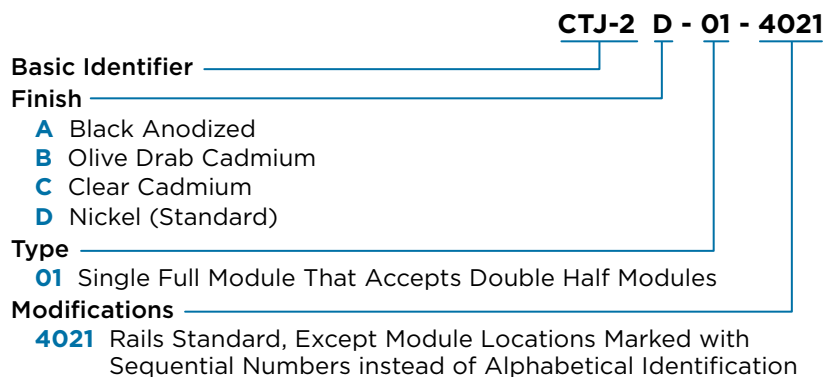



## DEUTSCH CTJ3 Series Metallic Rails

### VERSATILE

- Designed to hold up to 50 variations
- Elongated mounting holes for easy installation
- Available in sizes ranging from 2" to 40"

### LIGHT WEIGHT

- Extruded aluminum alloy rail
- Stainless steel metal clip



CTJ3 metallic rails from TE Connectivity (TE) use aluminum alloy and stainless steel clips. They are available with a variety of finishes and sizes ranging from 2 to 40 inches.

### Frame Capacity

Longer rail sizes available; consult TE

| Length*<br>(Inch) | Frame Capacity      |            | A 6 .015 | B 6 .010 | Weight, Lb. |
|-------------------|---------------------|------------|----------|----------|-------------|
|                   | Sizes<br>22, 20, 16 | Size<br>12 |          |          |             |
| 02                | 2                   | 1          | 1.036    | 0.518    | 0.022       |
| 03                | 3                   | 1*         | 1.554    | 1.036    | 0.033       |
| 04                | 4                   | 2          | 2.072    | 1.554    | 0.043       |
| 05                | 5                   | 2*         | 2.590    | 2.072    | 0.054       |
| 06                | 6                   | 3          | 3.108    | 2.590    | 0.065       |
| 07                | 7                   | 3*         | 3.626    | 3.108    | 0.075       |
| 08                | 8                   | 4          | 4.144    | 3.626    | 0.086       |
| 09                | 9                   | 4*         | 4.662    | 4.144    | 0.097       |
| 10                | 10                  | 5          | 5.180    | 4.662    | 0.108       |
| 12                | 12                  | 6          | 6.216    | 5.698    | 0.130       |

\*Size includes room for one or more Size 22, 20, or 16 modules.

### Part Numbering System

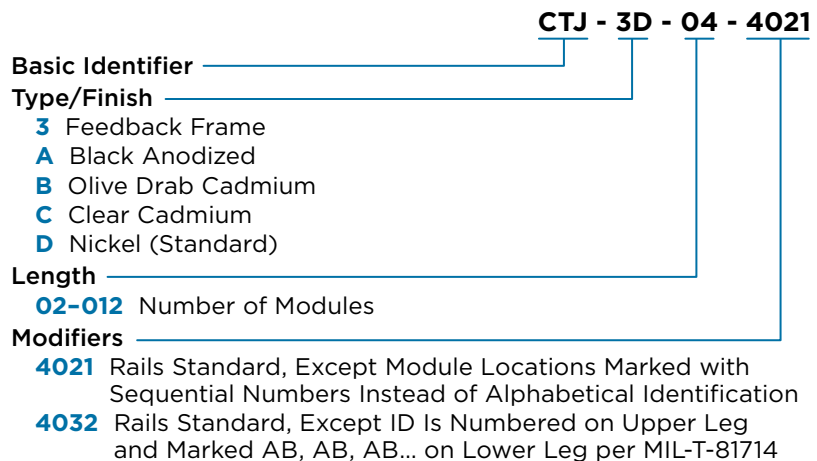



Outline Dimensions

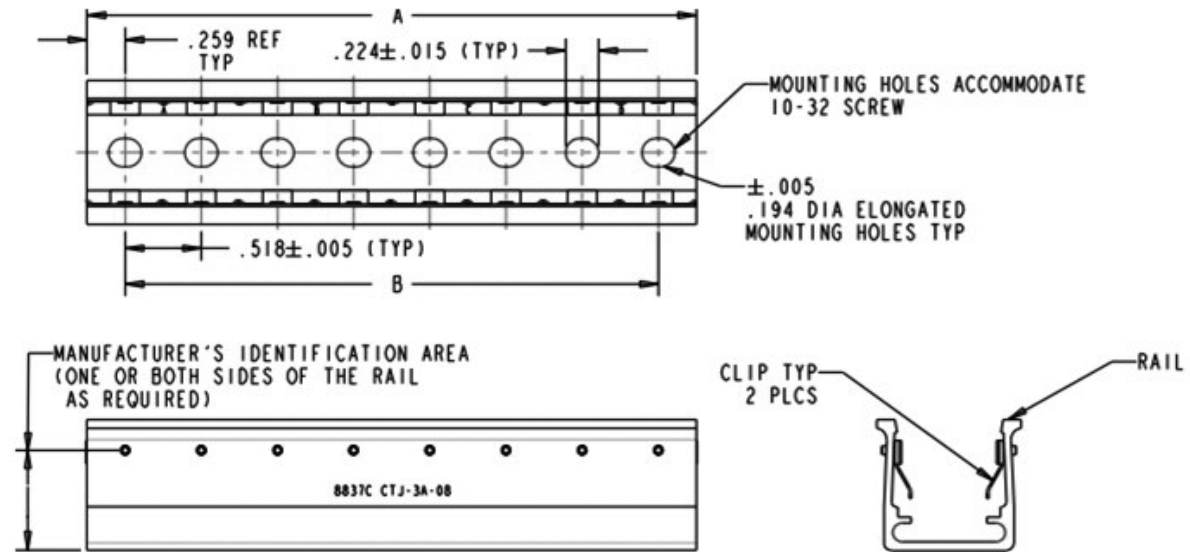



## DEUTSCH DCR Series Composite Rails

### LIGHT WEIGHT

- 48% lighter than comparable aluminum rails
- Composite version of CTJ3 rail

### VERSATILE

- Intermounts with MIL-T-81714 Series II rails
- Accepts MIL-T-8174M Series II modules
- Simple removal tooling

### HIGH PERFORMANCE

- Wide temperature range: -65°C to +175°C
- Environmentally sealed, fluid resistant
- Corrosion resistant



DEUTSCH DCR composite rails provide a lightweight, corrosion-resistant mounting system for electronic feedback and distribution modules. It is designed to allow hand insertion of each individual module. A positive lock retains the modules in the rails. Modules can be individually unlocked and removed by using a simple tool.

### Frame Capacity and Outline Dimensions

| No. of Modules | A 6 .015 | B 1 .010 | Weight, Oz. (g) |
|----------------|----------|----------|-----------------|
| 02             | 1.036    | 0.518    | 0.19 (5.30)     |
| 03             | 1.554    | 1.036    | 0.28 (7.95)     |
| 04             | 2.072    | 1.554    | 0.37 (10.60)    |
| 05             | 2.590    | 2.072    | 0.47 (13.25)    |
| 06             | 3.108    | 2.590    | 0.56 (15.90)    |
| 07             | 3.626    | 3.108    | 0.65 (18.55)    |
| 08             | 4.144    | 3.625    | 0.75 (21.20)    |
| 09             | 4.662    | 4.144    | 0.84 (23.85)    |
| 10             | 5.180    | 4.662    | 0.93 (26.50)    |
| 11             | 5.698    | 5.180    | 1.03 (29.25)    |
| 12             | 6.216    | 5.698    | 1.12 (31.80)    |
| 13             | 6.734    | 6.216    | 1.21 (34.45)    |
| 14             | 7.252    | 6.734    | 1.31 (37.10)    |
| 15             | 7.770    | 7.252    | 1.40 (39.75)    |
| 16             | 8.288    | 7.770    | 1.50 (42.40)    |
| 17             | 8.806    | 8.288    | 1.59 (45.05)    |
| 18             | 9.324    | 8.806    | 1.68 (47.70)    |
| 19             | 9.842    | 9.324    | 1.68 (50.35)    |
| 20             | 10.350   | 9.842    | 1.87 (53.00)    |





Outline Dimensions

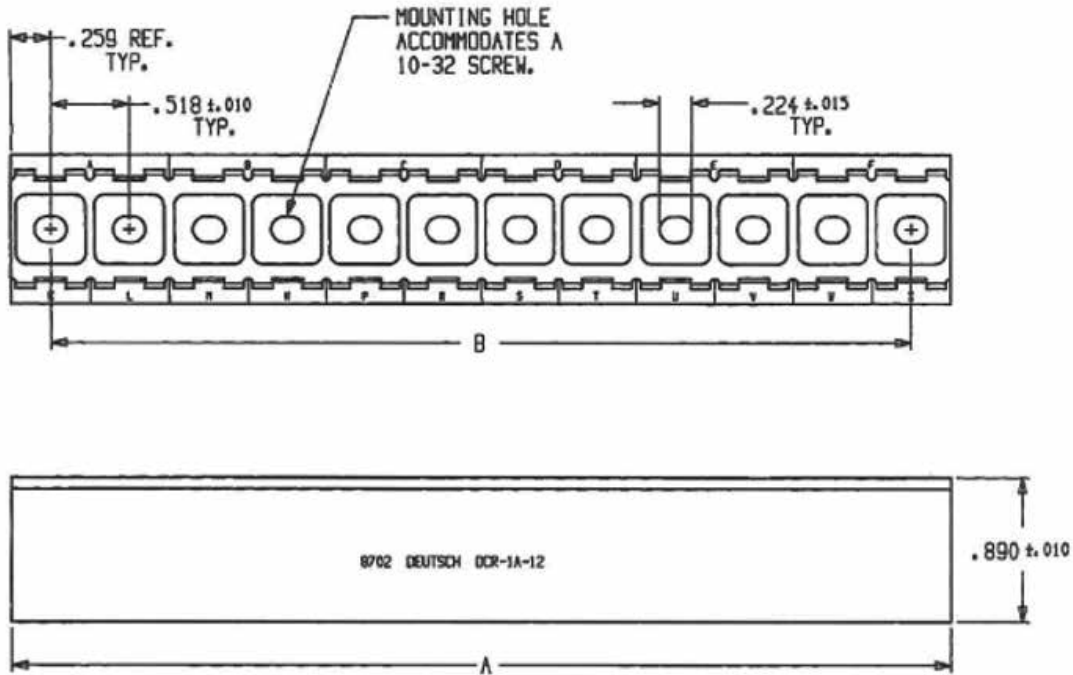

Part Numbering System

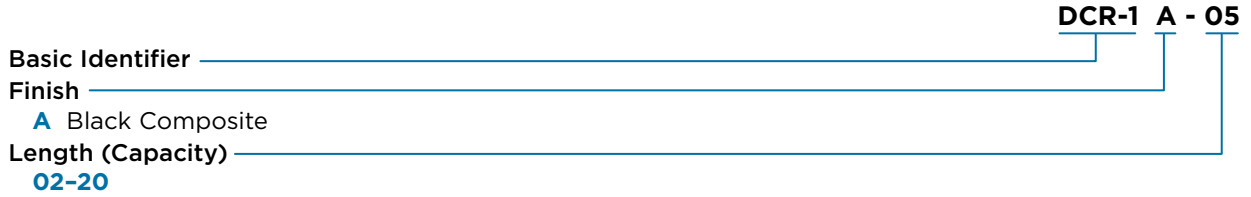



## Socket Contacts

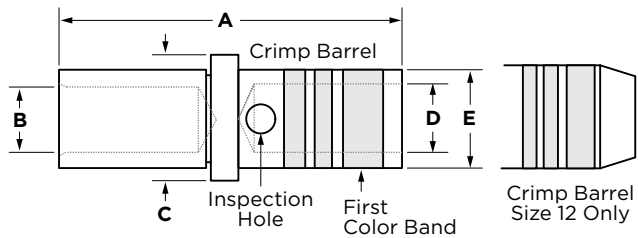

### Part Numbers and Outline Dimensions

| Contact Size | Part No.   | Mil Equivalent | A. Max. | B. Dia.     | C. Max. | D. Min. | E. Max. | Weight  |
|--------------|------------|----------------|---------|-------------|---------|---------|---------|---------|
| 22           | CTS-S22/22 | M39039/22-191  | 0.336   | 0.033/0.031 | 0.0615  | 0.033   | 0.048   | 0.00011 |
| 20           | CTS-S20/20 | M39039/22-192  | 0.358   | 0.044/0.042 | 0.0940  | 0.046   | 0.070   | 0.00027 |
| 16           | CTS-S16/16 | M39039/22-193  | 0.358   | 0.064/0.066 | 0.1300  | 0.066   | 0.103   | 0.00050 |
| 12           | CTS-S12/12 | M39039/22-605  | 0.455   | 0.100/0.097 | 0.17100 | 0.096   | 0.152   | 0.00145 |

### Application Information

| Contact Size | Part No.   | Color Bands        | Wire Strip Length | Wire Range (AWG) |
|--------------|------------|--------------------|-------------------|------------------|
| 22           | CTS-S22/22 | Brown-White-Brown  | 0.207 60.030      | 26-22            |
| 20           | CTS-S20/20 | Brown-White-Red    | 0.207 60.030      | 24-20            |
| 16           | CTS-S16/16 | Brown-White-Orange | 0.207 60.030      | 20-16            |
| 12           | CTS-S12/12 | Blue-Black-Green   | 0.225 60.020      | 14-12            |

## Reduced Diameter Contact Information

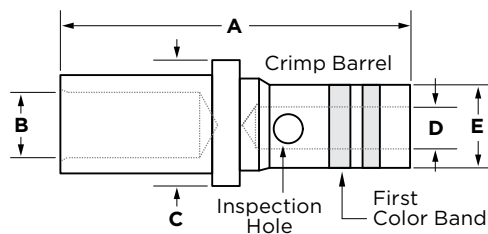

### Part Numbers and Outline Dimensions

| Contact Size | Part No.      | A. Max. | B. Dia.     | C. Max. | D. Min. | E. Max. | Weight (Lb.) |
|--------------|---------------|---------|-------------|---------|---------|---------|--------------|
| 20           | 1662-202-2031 | 0.358   | 0.044/0.042 | 0.0940  | 0.033   | 0.050   | 0.00027      |
| 16           | 1662-202-1631 | 0.358   | 0.064/0.066 | 0.1300  | 0.046   | 0.070   | 0.00050      |
| 12           | 1662-202-1231 | 0.460   | 0.100/0.097 | 0.17100 | 0.066   | 0.103   | 0.00145      |

### Application Information

| Contact Size | Part No.      | Color Bands | Wire Strip Length | Wire Range (AWG) |
|--------------|---------------|-------------|-------------------|------------------|
| 20           | 1662-202-2031 | Red-Green   | 0.207 60.030      | 26-22            |
| 16           | 1662-202-1631 | Blue-Red    | 0.207 60.030      | 24-20            |
| 12           | 1662-202-1231 | Yellow-Blue | 0.225 60.020      | 20-16            |

## Contact Tooling and Sealing Plug

| Contact Size | Crimp Tool          |                     | Ins/Ext Tool | Unwired Removal Tool | Sealing Plug |        |
|--------------|---------------------|---------------------|--------------|----------------------|--------------|--------|
|              | Tooling             | Positioner          |              |                      | Part No.     | Color  |
| 22           | MH860 (M22520/7-01) | 86-19 (M22520/7-11) | M81969/14-01 | 81517-23             | MS27488-22   | Black  |
| 20           | MH860 (M22520/7-01) | 86-20 (M22520/7-12) | M81969/14-10 | M15574-20            | MS27488-20   | Red    |
| 16           | MH860 (M22520/7-01) | 86-21 (M22520/7-13) | M81969/14-03 | M15574-16            | MS27488-16   | Green  |
| 12           | AF8 (M22520/1-01)   | M22520/1-16         | M81969/16-03 | M15574-16            | MS27488-12   | Orange |



## DEUTSCH CTJ Series Tooling

### Contact Insertion/Removal Tool



| Contact Size | Part No.     | Color        | Unwired Removal Tool |
|--------------|--------------|--------------|----------------------|
| 22           | M81969/14-01 | Green/White  | 81517-23             |
| 20           | M81969/14-10 | Red/Orange   | M15574-20            |
| 16           | M81969/14-03 | Blue/White   | M15574-16            |
| 22           | M81969/16-03 | Yellow/White | M15574-16            |

### Contact Crimping Tool



| Contact Size | Contact Part No. |               | Crimp Tool Part No. |                     |
|--------------|------------------|---------------|---------------------|---------------------|
|              | TE               | MIL           | Tooling             | Positioner          |
| 22           | CTS-S22/22       | M39029/22-191 | MH860 (M22520/7-01) | 86-19 (M22520/7-11) |
| 20           | CTS-S20/20       | M39029/22-192 | MH860 (M22520/7-01) | 86-20 (M22520/7-12) |
| 16           | CTS-S16/16       | M39029/22-193 | MH860 (M22520/7-01) | 86-21 (M22520/7-13) |
| 22           | CTS-S12/12       | M39029/22-605 | AF8 (M22520/1-01)   | M22520/1-16         |

### CTJ Module Removal Tools

The removal tools make it fast and simple to remove modules from a rail or to unmate CTJ6 and CTJ9 plug and receptacle connectors.

#### Part Numbers



**CTJ-R06**  
(Use with CTJ6 and CTJ9 Series)

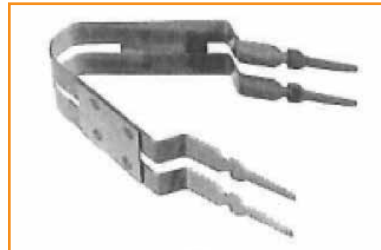

**CTJ-R12**  
(Use with Rail-Mounted Modules)

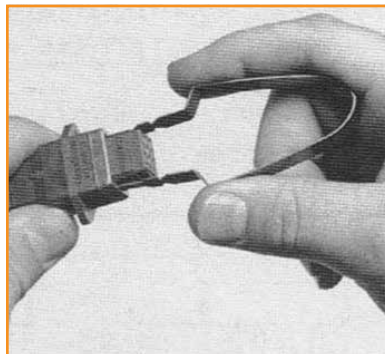



## Terminating CTJ AS39029 Contacts

Make sure you have the proper tool and positioner for the contact being crimped.



| Contact Size | Crimp Tool          |                     |
|--------------|---------------------|---------------------|
|              | Tooling             | Positioner          |
| 22           | MH860 (M22520/7-01) | 86-19 (M22520/7-11) |
| 20           | MH860 (M22520/7-01) | 86-20 (M22520/7-12) |
| 16           | MH860 (M22520/7-01) | 86-21 (M22520/7-13) |
| 22           | AF8 (M22520/1-01)   | M22520/1-16         |



Strip the wire to the proper dimension using an appropriate tool and method.



Insert the contact into the tool with the crimp barrel facing up.

| Contact Size | Strip Length              |
|--------------|---------------------------|
| 22, 20, 16   | 0.207 60.030 (5.26 60.76) |
| 12           | 0.225 60.030 (5.72 60.76) |



Insert the stripped conductor into the contact's crimp barrel.

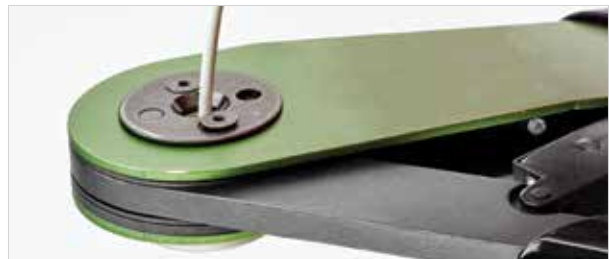

Cycle the crimping tool by squeezing the handles. The handles will not release until the tool has fully cycled.



Remove the wire and inspect the termination.

A proper termination has:

- 8 indent markings
- Wire observable through the contact side hold
- No loose or nicked wire strands



## Inserting and Removing Contacts

The colored end is used for insertion. The white or orange end is used for withdrawal.



| Contact Size | Tool Part No. | Color        |
|--------------|---------------|--------------|
| 22           | M81969/14-01  | Green/White  |
| 20           | M81969/14-10  | Red/Orange   |
| 16           | M81969/14-03  | Blue/White   |
| 12           | M81969/16-03  | Yellow/White |

### Inserting Contacts



Insert the wire into the tool's slot. Pull back gently on the wire until the contact's retention shoulder seats against the tip of the tool.



Insert the contact in the proper module cavity. Push the contact completely in. Then remove the tool. Lightly pull the wire back to make sure the contact is correctly seated.

### Removing Contacts



Wrap the tool's slot around the wire. Slide the tool into the cavity until it butts against the contact shoulder.



Press the wire between your fingers and the tool. Pull the wire and tool back together.

**Note:** When using minimum diameter wire, the tool may have a tendency to stop against the rear of the contact crimp barrel. If this should occur, careful manipulation of the tool will permit it to ride over the crimp barrel and into the proper position to unlock the contact.



### Installing Sealing Plugs

Sealing plugs are installed with the head towards the mating end of connector. Use the contact insertion tool if needed.



## Cross Reference DEUTSCH CTJ to AS81714

### Modules

| DEUTSCH Part No. | Mil Spec        |
|------------------|-----------------|
| CTJ112E01E-513   | M81714/60-12-01 |
| CTJ112E02A-513   | M81714/60-12-02 |
| CTJ112E03B-513   | M81714/60-12-03 |
| CTJ116E01D-513   | M81714/60-16-01 |
| CTJ116E02B-513   | M81714/60-16-02 |
| CTJ116E03A-513   | M81714/60-16-03 |
| CTJ120E01B-513   | M81714/60-20-01 |
| CTJ120E02C-513   | M81714/60-20-02 |
| CTJ120E03D-513   | M81714/60-20-03 |
| CTJ120E04A-513   | M81714/60-20-04 |
| CTJ120E06E-513   | M81714/60-20-06 |
| CTJ122E01C-513   | M81714/60-22-01 |
| CTJ122E02D-513   | M81714/60-22-02 |
| CTJ122E04F-513   | M81714/60-22-04 |
| CTJ122E05E-513   | M81714/60-22-05 |
| CTJ122E06B-513   | M81714/60-22-06 |
| CTJ122E10A-513   | M81714/60-22-10 |
| CTD1062E05A-513  | M81714/61-0W    |
| CTD126E02E-513   | M81714/61-0X    |
| CTD160E01F-513   | M81714/61-0Y    |
| CTD126E01A-513   | M81714/61-0Z    |
| CTJ712K01E-7067  | M81714/63-12F   |
| CTJ716K01D-7067  | M81714/63-16F   |
| CTJ716E01D-7067  | M81714/63-16S   |
| CTJ720K01B-7067  | M81714/63-20F   |
| CTJ720E01B-7067  | M81714/63-20S   |
| CTJ722K01C-7067  | M81714/63-22F   |
| CTJ722E01C-7067  | M81714/63-22S   |

### Module Removal Tool

| DEUTSCH Part No. | Mil Spec     |
|------------------|--------------|
| CTJ-R06          | M81714/69-01 |
| CTJ-R12          | M81714/69-02 |

### Junctions

| DEUTSCH Part No. | Mil Spec       |
|------------------|----------------|
| CTL-12-513       | M81714/65-12-1 |
| CTM-12-513       | M81714/65-12-2 |
| CTL-16-513       | M81714/65-16-1 |
| CTM-16-513       | M81714/65-16-2 |
| CTL-20-513       | M81714/65-20-1 |
| CTM-20-513       | M81714/65-20-2 |
| CTL-22-513       | M81714/65-22-1 |
| CTM-22-513       | M81714/65-22-2 |

### Rails

| DEUTSCH Part No. | Mil Spec     |
|------------------|--------------|
| CTJ-3A-02-4032   | M81714/67-02 |
| CTJ-3A-03-4032   | M81714/67-03 |
| CTJ-3A-04-4032   | M81714/67-04 |
| CTJ-3A-05-4032   | M81714/67-05 |
| CTJ-3A-06-4032   | M81714/67-06 |
| CTJ-3A-07-4032   | M81714/67-07 |
| CTJ-3A-08-4032   | M81714/67-08 |
| CTJ-3A-09-4032   | M81714/67-09 |
| CTJ-3A-10-4032   | M81714/67-10 |
| CTJ-3A-12-4032   | M81714/67-12 |
| CTJ-3A-13-4032   | M81714/67-13 |
| CTJ-3A-14-4032   | M81714/67-14 |
| CTJ-3A-15-4032   | M81714/67-15 |
| CTJ-3A-16-4032   | M81714/67-16 |
| CTJ-3A-18-4032   | M81714/67-18 |
| CTJ-3A-19-4032   | M81714/67-19 |
| CTJ-3A-20-4032   | M81714/67-20 |
| CTJ-3A-21-4032   | M81714/67-21 |
| CTJ-3A-25-4032   | M81714/67-25 |
| CTJ-3A-30-4032   | M81714/67-30 |
| CTJ-3A-40-4032   | M81714/67-40 |



## Notes

## LET'S CONNECT

We make it easy to connect with our experts and are ready to provide all the support you need. Just call your local support number or visit [te.com](http://te.com) to chat with a Product Information Specialist.

## Technical Support

[te.com/support-center](http://te.com/support-center)

|                      |                 |              |                    |
|----------------------|-----------------|--------------|--------------------|
| North America        | +1 800 522 6752 | Asia Pacific | +86 400 820 6015   |
| North America (Toll) | +1 717 986 7777 | Japan        | +81 044 844 8180   |
| EMEA/South Africa    | +800 0440 5100  | Australia    | +61 2 9554 2695    |
| EMEA (Toll)          | +31 73 624 6999 | New Zealand  | +64 (0) 9 634 4580 |
| India (Toll-Free)    | +800 440 5100   |              |                    |

[te.com/deutsch-ctj](http://te.com/deutsch-ctj)

AMP, AGASTAT, CII, DEUTSCH, HARTMAN, KILOVAC, MICRODOT, NANONICS, POLAMCO, Raychem, SEACON, TE, TE Connectivity and the TE connectivity (logo) are trademarks of TE Connectivity. Other products, logos, and company names mentioned herein may be trademarks of their respective owners.

While TE Connectivity (TE) has made every reasonable effort to ensure the accuracy of the information herein, nothing herein constitutes any guarantee that such information is error-free, or any other representation, warranty or guarantee that the information is accurate, correct, reliable or current. The TE entity issuing this publication reserves the right to make any adjustments to the information contained herein at any time without notice. All implied warranties regarding the information contained herein, including, but not limited to, any implied warranties of merchantability or fitness for a particular purpose are expressly disclaimed. The dimensions herein are for reference purposes only and are subject to change without notice. Specifications are subject to change without notice.

Consult TE for the latest dimensions and design specifications.

© 2018 TE Connectivity. All Rights Reserved.

1-1773867-9 06/18