

ONE STEP BAND STRAP - STRAIGHT

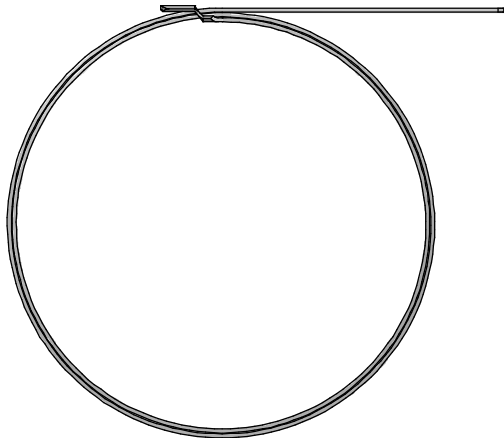

TWO STEP BAND STRAP - STRAIGHT

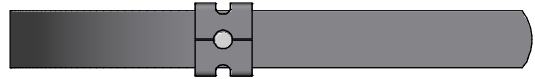
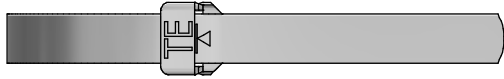

ONE STEP BAND STRAP - PRE-COILED

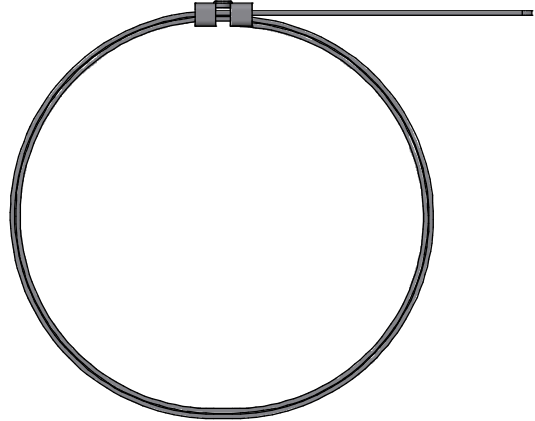

TWO STEP BAND STRAP - PRE-COILED

BND-0812X

SCREEN TERMINATION BAND  
 BAND LENGTH  
 AND BUCKLE TYPE IDENTIFIER  
 BAND WIDTH IDENTIFIER  
 BAND CONFIGURATION  
 S - STRAIGHT (FLAT)  
 P - PRE-COILED

NOTES:

1. THE BAND STRAPS ARE CONSTRUCTED FROM 300 SERIES PASSIVATED CORROSION RESISTING STEEL.
2. THE PRODUCT SHALL BE IDENTIFIED ON THE PACKAGE LABEL.
3. PART MARKING:  
 ONE STEP BAND STRAP WILL BE PERMANENTLY MARKED WITH TE LOGO.  
 TWO STEP BAND STRAP WILL BE PERMANENTLY MARKED WITH TE LOGO.
4. RECOMMENDED INSTALLATION TOOLS:  
 BND-0812X: M81306/1-02 OR EQUIVALENT.  
 BND-1412X: M81306/1-02 OR EQUIVALENT.  
 BND-1425X : M81306/1-01 OR EQUIVALENT.  
 BND-1225X : TF1700 OR EQUIVALENT.  
 BND-1212X: M81306/2-02 OR EQUIVALENT.
5. THE INSTALLATION TOOL FOR ONE STEP BAND AND TWO STEP BAND ARE NOT INTERCHANGEABLE.

DRAWN	K.WINCZURA	DATE	02/06/2016	 3RD ANGLE PROJECTION NOT TO SCALE
CHECKED		DATE	02/06/2016	
APPROVED	K.SHEPPARD	DATE	30/10/2015	
APPROVED	D.JONES	DATE	26/07/2016	
UNLESS OTHERWISE SPECIFIED ALL DIMENSIONS IN MILLIMETRES <b>GENERAL TOL</b> LINEAR +/-0.25MM ANGULAR +/- 1°				

TITLE:

BND-\*\*\*\*\*

ASSY USED ON:

SCREEN TERMINATION BAND

REVISIONS			
LTR	DESCRIPTION	DATE	APPROVED
F	REVISED PER ECO-16-011070	26/07/2016	D.JONES
G	REVISED PER ECO-18-004857	03/04/2018	D.JONES

TE CAGE CODE: 06090  
 POLAMCO/TE CAGE CODE: U5792

TE CONNECTIVITY - POLAMCO LTD RESERVES THE RIGHT TO AMEND THIS DRAWING AND THE INFORMATION SET FORTH HEREON AT ANY TIME. USERS SHOULD INDEPENDENTLY EVALUATE THE SUITABILITY OF THE PRODUCT FOR THEIR APPLICATION.

DRAWING NO:  
 BND-XXXXX

DRAWING REV:  
 G

SHT  
 1



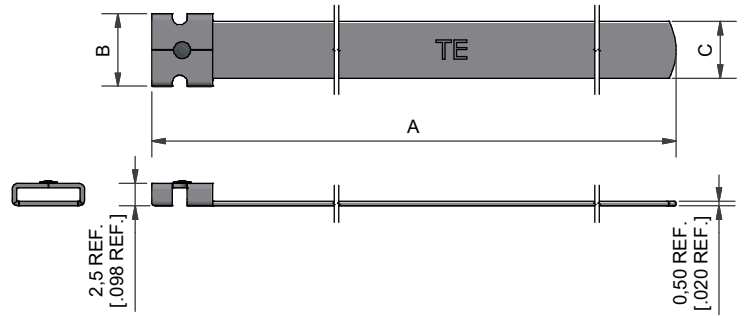
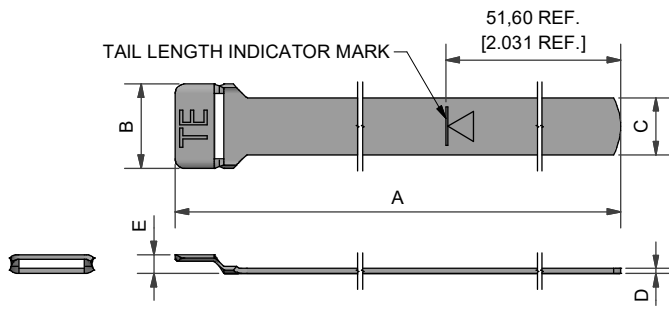

ONE STEP BAND STRAP - STRAIGHT

PART NUMBER	ENTRY SIZE	A ±1,8 [±.071]	B ±1,0 [±.040]	C ±0,2 [±.010]	D REF.	E REF.
BND-0812S	03 TO 12	206,3 [8.120]	5,0 [.197]	2,9 [.114]	0,4 [.016]	1,8 [.071]
BND-1412S	03 TO 24	362,0 [14.252]	5,0 [.197]	2,9 [.114]	0,4 [.016]	1,8 [.071]
BND-1425S	03 TO 24	362,1 [14.260]	8,9 [.350]	6,2 [.244]	0,5 [.020]	1,9 [.075]

TWO STEP BAND STRAP - STRAIGHT

PART NUMBER	ENTRY SIZE	A ±1,8 [±.071]	B ±1,0 [±.040]	C ±0,2 [±.010]
BND-1225S	03 TO 24	358,8 [14.126]	8,3 [.327]	6,2 [.244]
BND-1212S	03 TO 24	362,0 [14.252]	5,0 [.197]	3,0 [.118]

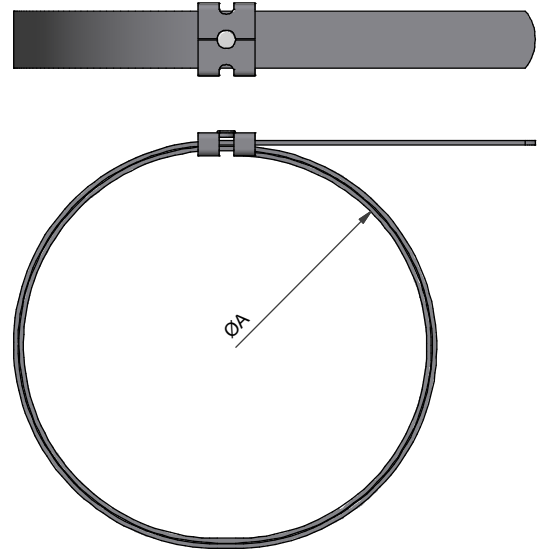
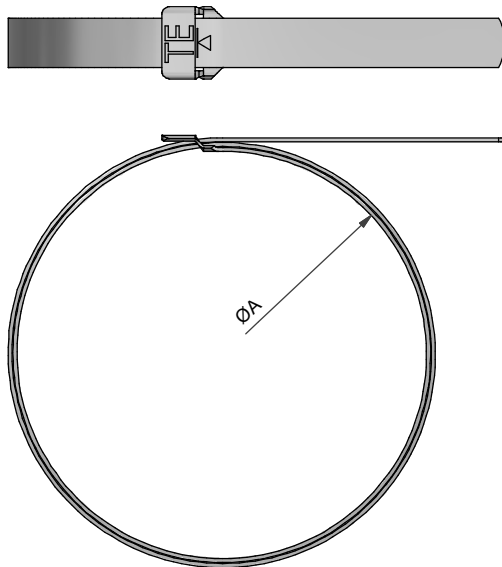

ONE STEP BAND STRAP - PRE-COILED

PART NUMBER	ENTRY SIZE	ØA REF
BND-0812P	03 TO 12	21,8 [.858]
BND-1412P	03 TO 24	44,5 [1.752]
BND-1425P	03 TO 24	44,5 [1.752]

TWO STEP BAND STRAP - PRE-COILED

PART NUMBER	ENTRY SIZE	ØA REF
BND-1225P	03 TO 24	44,5 [1.752]
BND-1212P	03 TO 24	44,5 [1.752]

DRAWN	K.WINCZURA	DATE	02/06/2016
CHECKED		02/06/2016	
APPROVED	K.SHEPPARD	30/10/2015	UNLESS OTHERWISE SPECIFIED ALL DIMENSIONS IN MILLIMETRES <b>GENERAL TOL</b> LINEAR +/-0.25MM ANGULAR +/- 1°
APPROVED	D.JONES	26/07/2016	

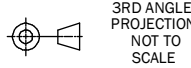

TITLE:

BND-\*\*\*\*

ASSY USED ON:

SCREEN TERMINATION BAND

REVISIONS

LTR	DESCRIPTION	DATE	APPROVED
F	REVISED PER ECO-16-011070	26/07/2016	D.JONES
G	REVISED PER ECO-18-004857	03/04/2018	D.JONES

TE CAGE CODE: 06090  
POLAMCO/TE CAGE CODE: U5792

TE CONNECTIVITY - POLAMCO LTD RESERVES THE RIGHT TO AMEND THIS DRAWING AND THE INFORMATION SET FORTH HEREON AT ANY TIME. USERS SHOULD INDEPENDENTLY EVALUATE THE SUITABILITY OF THE PRODUCT FOR THEIR APPLICATION.

DRAWING NO:  
BND-XXXXX

DRAWING REV:  
G

SHT  
2

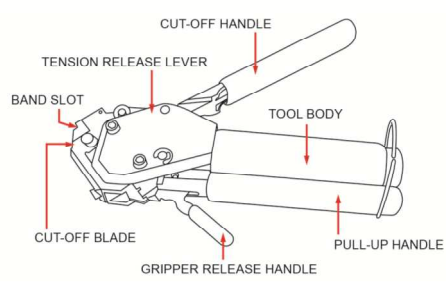
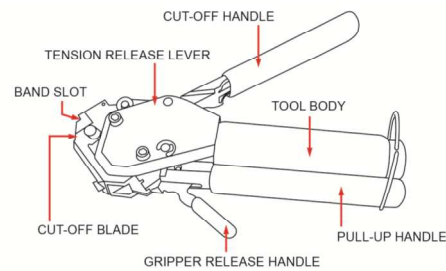
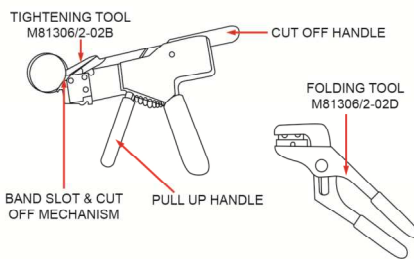
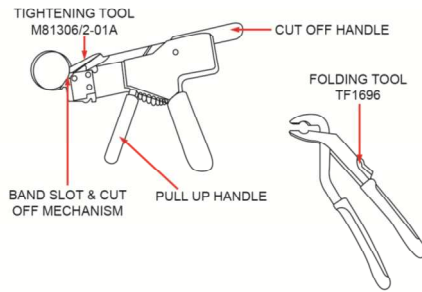

PART NUMBER	DESCRIPTION	BAND SLOT WIDTH (MM)	VISUALISATION
M81306/1-02	PRE-CALIBRATED HAND TOOL FOR ONE STEP MICRO BAND BND-0812S BND-0812P BND-1412S BND-1412P	3,18	
M81306/1-01	PRE-CALIBRATED HAND TOOL FOR ONE STEP STANDARD BANDS BND-1425S BND-1425P	6,35	
M81306/2-02 INCLUDES: - TIGHTENING TOOL - M81306/2-02B - FOLDING TOOL - M81306/2-02D	PRE-CALIBRATED HAND TOOL FOR TWO STEP BAND BND-1212S BND-1212P	3,18	
TF1700 INCLUDES: - TIGHTENING TOOL - M81306/2-01A - FOLDING TOOL - TF1696 (SLIP JOINT PLIERS)	PRE-CALIBRATED HAND TOOL FOR TWO STEP BAND BND-1225S BND-1225P	6,65	

<b>DRAWN</b>	K.WINCZURA	DATE	02/06/2016
<b>CHECKED</b>		DATE	02/06/2016
<b>APPROVED</b>	K.SHEPPARD	DATE	30/10/2015
<b>APPROVED</b>	D.JONES	DATE	26/07/2016
<b>REVISIONS</b>			
<b>LTR</b>	<b>DESCRIPTION</b>	<b>DATE</b>	<b>APPROVED</b>
F	REVISED PER ECO-16-011070	26/07/2016	D.JONES
G	REVISED PER ECO-18-004857	03/04/2018	D.JONES
TE CAGE CODE: 06090 POLAMCO/TE CAGE CODE: U5792			

3RD ANGLE PROJECTION NOT TO SCALE

UNLESS OTHERWISE SPECIFIED ALL DIMENSIONS IN MILLIMETRES

**GENERAL TOL**  
LINEAR +/-0.25MM  
ANGULAR +/- 1°

**TITLE:**  
**RECOMMENDED TOOLING**

**ASSY USED ON:**  
**SCREEN TERMINATION BAND**

TE CONNECTIVITY - POLAMCO LTD RESERVES THE RIGHT TO AMEND THIS DRAWING AND THE INFORMATION SET FORTH HEREON AT ANY TIME. USERS SHOULD INDEPENDENTLY EVALUATE THE SUITABILITY OF THE PRODUCT FOR THEIR APPLICATION.

DRAWING NO: BND-XXXXX

DRAWING REV: G

SHT 3



**Polamco**  
TE connectivity