

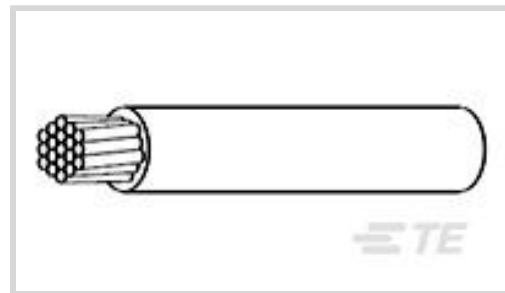

Wire & Cable > Hook Up Wire



Cable Type: **FlexLite TW**

Voltage Rating: **600 V**

Insulation Material: **Flame-Retardant, Modified Polyester**

Conductor Material: **Tin-Coated Copper**

Wire Size: **16 AWG**

Features

Product Type Features

Product Type	Wire
Product Classification	Wire - Commercial
Cable Style	Primary, Stranded
Cable Type	FlexLite TW

Configuration Features

Number of Conductors	1
Number of Strands	19

Electrical Characteristics

Resistance (Max)	4.82 Ω/1000 ft @ 68°F
Voltage Rating	600 V

Body Features

Weight	12.2 kg/km
Wire Color	White
Insulation Material	Flame-Retardant, Modified Polyester
Conductor Material	Tin-Coated Copper

Dimensions

	16 AWG
Overall Outside Diameter Range	1.75 – 1.91 mm [.069 – .075 in]
Conductor Diameter	1.33 mm [.053 in]



Strand Size	29 AWG
Wire Size	1.31 mm ²

Usage Conditions

Operating Temperature Range	-65 – 135 °C
-----------------------------	--------------

Product Compliance

[For compliance documentation, visit the product page on TE.com>](#)

EU RoHS Directive 2011/65/EU	Compliant
EU ELV Directive 2000/53/EC	Compliant
China RoHS 2 Directive MIIT Order No 32, 2016	No Restricted Materials Above Threshold
EU REACH Regulation (EC) No. 1907/2006	Current ECHA Candidate List: JAN 2019 (197) Candidate List Declared Against: JAN 2019 (197)
Halogen Content	Out of Scope - excluded from Halogen requirements
Solder Process Capability	Not applicable for solder process capability

Product Compliance Disclaimer

This information is provided based on reasonable inquiry of our suppliers and represents our current actual knowledge based on the information they provided. This information is subject to change. The part numbers that TE has identified as EU RoHS compliant have a maximum concentration of 0.1% by weight in homogenous materials for lead, hexavalent chromium, mercury, PBB, PBDE, DBP, BBP, DEHP, DIBP, and 0.01% for cadmium, or qualify for an exemption to these limits as defined in the Annexes of Directive 2011/65/EU (RoHS2). Finished electrical and electronic equipment products will be CE marked as required by Directive 2011/65/EU. Components may not be CE marked. Additionally, the part numbers that TE has identified as EU ELV compliant have a maximum concentration of 0.1% by weight in homogenous materials for lead, hexavalent chromium, and mercury, and 0.01% for cadmium, or qualify for an exemption to these limits as defined in the Annexes of Directive 2000/53/EC (ELV). Regarding the REACH Regulations, TE's information on SVHC in articles for this part number is still based on the European Chemical Agency (ECHA) 'Guidance on requirements for substances in articles' (Version: 2, April 2011), applying the 0.1% weight on weight concentration threshold at the finished product level. TE is aware of the European Court of Justice ruling of September 10th, 2015 also known as O5A (Once An Article Always An Article) stating that, in case of 'complex object', the threshold for a SVHC must be applied to both the product as a whole and simultaneously to each of the articles forming part of its composition. TE has evaluated this ruling based on the new ECHA "Guidance on requirements for substances in articles" (June 2017, version 4.0) and will be updating its statements accordingly.

Customers Also Bought



TE Part #42938-2
RING 16-14 AWG TPBR

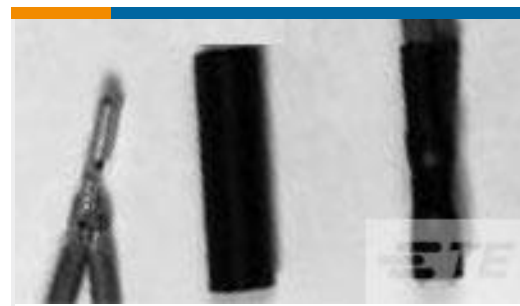

TE Part #520206K014
RT-3-NO.1-0-1IN

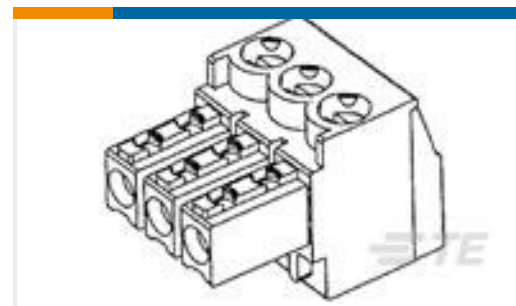

TE Part #1-284509-5
15P TERMI-BLOK PLUG
STACK 3,8

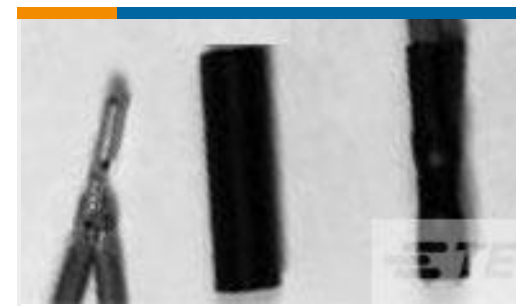

TE Part #278414-000
RT-3-NO.2-0-COIL

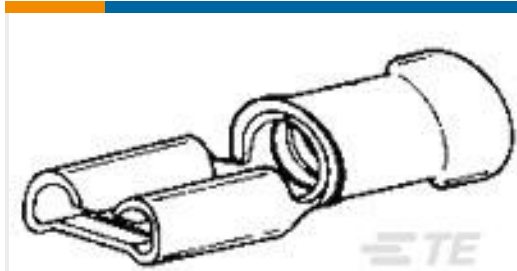

TE Part #140802-2
TERMINAL REC FASTON
PIDG 5

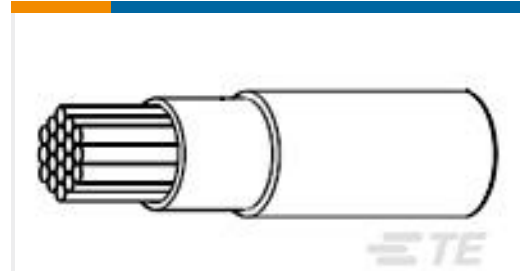

TE Part #020943-000
FLDWC0311-18-2

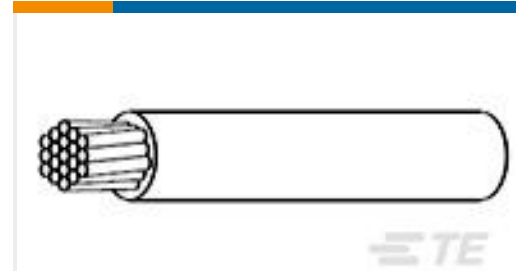

TE Part #512307-000
FLTWC0311-18-1

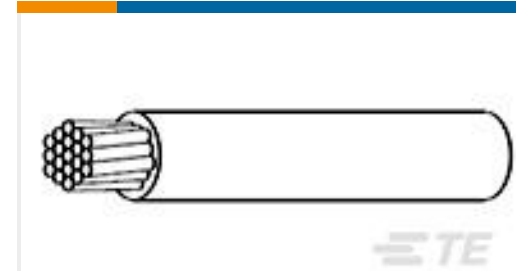

TE Part #E27235-000
FLTWC0311-18-5

Documents

Product Drawings

[FLTWC0311-16-9](#)

English

Datasheets & Catalog Pages

[1654025_Sec9_FlexLite](#)

English

Product Specifications

[Product Specification](#)

English