



ALUMINUM ELECTROLYTIC CAPACITORS

CAT. No. E1001M(Ver.2)

INDEX		
PRODUCT SEARCH	SERIES TABLE	➔
	GROUP CHART	➔
PRODUCT GUIDE	PRECAUTIONS AND GUIDELINES (Conductive Polymer)	➔
	PRECAUTIONS AND GUIDELINES (Aluminum Electrolytic Capacitor)	➔
	PART NUMBERING SYSTEM	➔
	ENVIRONMENTAL CONSIDERATION	➔
	PACKAGING	➔
	TAPING SPECIFICATIONS	➔
	AVAILABLE TERMINALS FOR SNAP-IN AND SCREW-MOUNT TYPE	➔
	STANDARDIZATION	➔
	WORLD-WIDE MANUFACTURING LOCATIONS	➔
	RECOMMENDED REFLOW CONDITION	➔
PRODUCT SPECIFICATION	CONDUCTIVE POLYMER ELECTROLYTE TYPE	➔
	CHIP TYPE ALUMINUM ELECTROLYTIC CAPACITOR	➔
	RADIAL LEAD TYPE ALUMINUM ELECTROLYTIC CAPACITOR	➔
	SNAP-IN TYPE ALUMINUM ELECTROLYTIC CAPACITOR	➔
	SCREW TERMINAL TYPE ALUMINUM ELECTROLYTIC CAPACITOR	➔
TECHNICAL NOTE		➔
RELIABILITY TEST DATA		➔
APPENDIX		➔

Series		Features	Endurance (+R=With ripple)	Standard Type	Low impedance	Solvent resistant	Terminal type	Rated voltage range (Vdc)	Capacitance range (μF)
Conductive Polymer Electrolyte Type	Surface Mount Type	PXG <small>(NEW)</small>	Super low ESR, high ripple current, downsized	105°C 1,000 to 2,000 hours	●	●	SMD	16 to 25	10 to 820
		PXK	Super low ESR, high ripple current, downsized	105°C 1,000 to 2,000 hours	●	●	SMD	2.5 to 16	100 to 560
		PXS	Long life, super low ESR, high ripple current	105°C 5,000 hours	●	●	SMD	4 to 16	22 to 560
		PXF <small>(Upgrade!)</small>	Super low ESR, high ripple current	105°C 1,000 to 2,000 hours	●	●	SMD	2 to 10	120 to 1,000
		PXE	Super low ESR, high ripple current	105°C 2,000 hours	●	●	SMD	2.5 to 16	33 to 2,700
		PXA	Super low ESR, high ripple current	105°C 1,000 to 2,000 hours	●	●	SMD	2.5 to 25	3.3 to 1,500
		PXD <small>(NEW)</small>	125°C, super low ESR, high ripple current	125°C 2,000 hours	●	●	SMD	2.5 to 10	47 to 470
	PXH	125°C, super low ESR, high ripple current	125°C 1,000 hours	●	●	SMD	2.5 to 20	22 to 1,000	
	Radial Lead Type	PSG <small>(Upgrade!)</small>	Long life, super low ESR, high ripple current	105°C 2,000 to 5,000 hours	●	●	Radial	16 to 25	56 to 1,000
		PSK <small>(Upgrade!)</small>	Long life, super low ESR, high ripple current	105°C 5,000 hours	●	●	Radial	2.5 to 6.3	220 to 560
		PSF <small>(Upgrade!)</small>	Long life, super low ESR, high ripple current	105°C 5,000 hours	●	●	Radial	2 to 16	100 to 1,600
		PSE	Long life, super low ESR, high ripple current	105°C 5,000 hours	●	●	Radial	2.5 to 6.3	470 to 820
		PSC	Super low ESR, high ripple current	105°C 2,000 hours	●	●	Radial	2.5 to 16	270 to 2,700
		PSA	Super low ESR, high ripple current	105°C 2,000 hours	●	●	Radial	2.5 to 16	47 to 1,500
PS		Super low ESR, high ripple current	105°C 2,000 hours	●	●	Radial	2.5 to 35	18 to 1,500	
Surface Mount Type	General Purpose	MVA	85°C, standard	85°C 2,000 hours	●	▲	SMD	4 to 450	1.0 to 10,000
		MVE	105°C, standard	105°C 1,000 to 2,000 hours	●	▲	SMD	6.3 to 450	1.0 to 6,800
	Low Impedance	MZJ	Super low ESR	105°C 2,000 hours	●	●	SMD	6.3 to 35	10 to 1,800
		MZA	Super low impedance	105°C 2,000 hours	●	●	SMD	6.3 to 80	3.3 to 1,500
		MVY	Low impedance, standard, Case size φ 4 to 18mm	105°C 1,000 to 5,000 hours	●	▲	SMD	6.3 to 100	1.0 to 8,200
		MZF	10,000 hours, Long life, low impedance	105°C 10,000 hours	●	●	SMD	6.3 to 50	10 to 470
		MZE	7,000/8,000 hours, Long life, low impedance	105°C 7,000 to 8,000 hours	●	●	SMD	6.3 to 50	10 to 470
		MZK	5,000 hours, Long life, low impedance	105°C 5,000 hours	●	●	SMD	6.3 to 35	10 to 150
		MLA	3,000 hours, Long life, low impedance	105°C 3,000 hours	●	●	SMD	6.3 to 50	10 to 1,000
	Long Life	MLF	10,000 hours, Long life	105°C 10,000 hours	●	●	SMD	6.3 to 50	1.0 to 1,000
		MLE	7,000/8,000 hours, Long life	105°C 7,000 to 8,000 hours	●	●	SMD	6.3 to 50	1.0 to 1,000
		MLK	5,000 hours, Long life	105°C 5,000 hours	●	●	SMD	6.3 to 35	4.7 to 100
		MVL	3,000/5,000 hours, Long life	105°C 3,000 to 5,000 hours	●	●	SMD	6.3 to 50	1.0 to 1,000
		MVJ	2,000 hours, Long life	105°C 2,000 hours	●	●	SMD	6.3 to 50	1.0 to 100
	Special Application	MVH	125°C, Case size φ 6.3 to 18mm	125°C 1,000 to 5,000 hours	●	▲	SMD	10 to 450	3.3 to 4,700
		MHB	125°C, Specified ESR after endurance	125°C 2,000 hours	●	●	SMD	10 to 35	47 to 470
		MHJ	125°C, Specified ESR after endurance	125°C 2,000 hours	●	●	SMD	10 to 35	47 to 470
		MKB	Specified ESR at low temperature	105°C 3,000 hours	●	●	SMD	400	2.2 to 4.7
MV-BP		Bi-polar	85°C 2,000 hours	●	●	SMD	6.3 to 50	1.0 to 47	
MVK-BP		Bi-polar	105°C 1,000 hours	●	●	SMD	6.3 to 50	1.0 to 47	
Radial Lead Type	Low Profile	SRM	5mm height, downsized	85°C 1,000 hours	●	●	Radial	4 to 50	1.0 to 330
		SRE	85°C, 5mm height, standard	85°C 1,000 hours	●	●	Radial	4 to 50	1.0 to 100
		KRE	105°C, 5mm height, standard	105°C 1,000 hours	●	●	Radial	6.3 to 50	1.0 to 100
		SRA	85°C, 7mm height, standard	85°C 1,000 hours	●	●	Radial	4 to 63	1.0 to 470
		KMA	105°C, 7mm height, standard	105°C 1,000 hours	●	●	Radial	4 to 63	1.0 to 220
		SRG	φ4×7 to φ18×25mm, low profile	85°C 1,000 to 2,000 hours	●	●	Radial	4 to 50	1.0 to 10,000
		KRG	φ4×7 to φ18×25mm, low profile	105°C 1,000 hours	●	●	Radial	6.3 to 50	1.0 to 10,000
		General Purpose	SMQ	85°C, Downsized	85°C 2,000 hours	●	▲	Radial	6.3 to 450
	KMQ		105°C, Downsized	105°C 1,000 to 2,000 hours +R	●	▲	Radial	6.3 to 450	1.0 to 47,000
	SMG		85°C, standard	85°C 2,000 hours	●	▲	Radial	6.3 to 450	1.0 to 39,000
	KMG		105°C, standard	105°C 1,000 to 2,000 hours +R	●	▲	Radial	6.3 to 450	1.0 to 22,000
	SME-BP		Bi-polar, downsized	85°C 2,000 hours	●	●	Radial	6.3 to 100	1.0 to 6,800
	KME-BP		Bi-polar, downsized	105°C 1,000 hours	●	●	Radial	6.3 to 100	1.0 to 6,800
	High Frequency Use	KZN <small>(NEW)</small>	Long life, low impedance	105°C 9,000 to 10,000 hours +R	●	●	Radial	6.3 to 100	56 to 22,000
		KZM	Long life, super low impedance	105°C 6,000 to 10,000 hours +R	●	●	Radial	6.3 to 50	27 to 10,000
		KZH	Super low impedance, downsized	105°C 5,000 to 6,000 hours +R	●	●	Radial	6.3 to 35	47 to 8,200
		KZE	Low impedance, downsized	105°C 1,000 to 5,000 hours +R	●	●	Radial	6.3 to 100	6.8 to 6,800
		KYB <small>(NEW)</small>	Low impedance, downsized	105°C 4,000 to 10,000 hours +R	●	●	Radial	6.3 to 100	6.8 to 22,000
		KYA <small>(Upgrade!)</small>	Low impedance, downsized	105°C 4,000 to 10,000 hours +R	●	●	Radial	6.3 to 100	1.0 to 15,000
		KY	Low impedance, standard	105°C 4,000 to 10,000 hours +R	●	●	Radial	6.3 to 100	1.0 to 18,000
		LZA <small>(NEW)</small>	Low impedance, downsized	105°C 4,000 to 5,000 hours +R	●	●	Radial	6.3 to 35	330 to 6,800
LXZ		Low impedance, downsized	105°C 2,000 to 8,000 hours +R	●	●	Radial	6.3 to 63	12 to 18,000	
LXY		Low impedance	105°C 2,000 to 8,000 hours +R	●	●	Radial	10 to 63	10 to 8,200	
LXV	Low impedance	105°C 2,000 to 5,000 hours +R	●	●	Radial	6.3 to 100	5.6 to 15,000		

● : Recommendation products

▲ : Some of range are solvent resistant.

Product specifications in this catalog are subject to change without notice. Request our product specifications before purchase and/or use. Please use our products based on the information contained in this catalog and product specifications.

Series		Features	Endurance (+R=With ripple)	Standard Type	Low impedance	Solvent resistant	Terminal type	Rated voltage range (Vdc)	Capacitance range (μF)	
Radial Lead Type	High Reliability	KXJ	Long life, downsized, for input filtering	105°C 10,000 to 12,000 hours +R			Radial	160 to 450	6.8 to 680	
		KXG	Long life, downsized, for input filtering	105°C 8,000 to 10,000 hours +R	●		Radial	160 to 450	6.8 to 330	
		SMH	For input filtering, φ 20×20 to φ 22×50mm (Ask Engineering Bulletin No808 in detail)	85°C 2,000 hours +R			Radial	160 to 450	33 to 470	
		KMH	For input filtering, φ 20×20 to φ 22×50mm (Ask Engineering Bulletin No810 in detail)	105°C 2,000 hours +R			Radial	160 to 450	33 to 470	
		KHE (NEW)	Low profile, for input filtering	105°C 2,000 hours +R			Radial	400 to 450	27 to 120	
		PAG	Low profile, for input filtering	105°C 2,000 hours +R			Radial	200 to 450	18 to 560	
		KLJ	No sparks with DC overvoltage, downsized	105°C 2,000 hours +R			Radial	200 & 400	4.7 to 330	
		KLG	No sparks with DC overvoltage	105°C 2,000 hours +R			Radial	200 & 400	22 to 330	
		LE (NEW)	Long life, downsized	105°C 10,000 hours +R		●	Radial	10 to 100	1.0 to 330	
		FL	Long life, downsized	105°C 3,000 hours +R		●	Radial	6.3 to 50	1.0 to 270	
		GPA (Upgrade!)	125°C, low impedance, downsized	125°C 3,000 to 5,000 hours +R		●	●	Radial	25 to 100	200 to 6,800
		GXE	125°C, low impedance, downsized	125°C 2,000 to 5,000 hours +R		●	▲	Radial	10 to 450	4.7 to 4,700
		GXL	125°C	125°C 5,000 hours +R			●	Radial	10 to 50	100 to 1,000
	GXH	135°C	135°C 1,500 / 2,000 hours +R			●	Radial	10 to 50	100 to 4,700	
	Special Application	LBG	For airbag	105°C 5,000 hours +R		●	●	Radial	25 & 35	1,000 to 11,000
		KZA	For PC motherboard (Ask Engineering Bulletin No809 in detail)	105°C 2,000 hours +R		●		Radial	6.3 to 16	470 to 3,300
LLA		Low DC leakage, general (Ask Engineering Bulletin No575 in detail)	85°C 1,000 hours			●	Radial	6.3 to 50	1.0 to 15,000	
PH		For photo flash	55°C 5,000 times charging				Radial	300 & 330	-	
Snap-in Type	General Purpose	SMQ	85°C, standard	85°C 2,000 hours +R	●		Pin	160 to 450	82 to 3,900	
		KMW (NEW)	105°C, super downsized	105°C 2,000 hours +R			Pin	400 to 450	120 to 1,000	
		KMR	105°C, downsized	105°C 2,000 hours +R			Pin	160 to 450	100 to 3,300	
		KMQ	105°C, standard	105°C 2,000 hours +R	●		Pin	35, 50, 160 to 450	68 to 33,000	
		SMM	85°C, 3,000 hours	85°C 3,000 hours +R	●		Pin	160 to 450	47 to 3,300	
		KMT (NEW)	105°C, high ripple	105°C 3,000 hours +R			Pin	420 & 450	82 to 680	
		KMS	105°C, downsized	105°C 3,000 hours +R	●		Pin	160 to 500	47 to 3,300	
		KMM	105°C, 2,000/3,000 hours	105°C 2,000 to 3,000 hours +R	●		Pin	160 to 450	39 to 3,300	
		SMH	85°C, standard (Ask Engineering Bulletin No585 for 160 to 450V)	85°C 2,000 hours +R			Pin	6.3 to 100	820 to 100,000	
		KMH	105°C, standard (Ask Engineering Bulletin No584 for 160 to 450V)	105°C 2,000 hours +R			Pin	6.3 to 100	560 to 82,000	
	Low Profile	SLM	15mm height, low profile	85°C 2,000 hours +R			Pin	160 to 400	47 to 560	
		KLM	15mm height, low profile	105°C 2,000 hours +R			Pin	160 to 400	39 to 390	
	High Reliability	TXH (NEW)	Long life	105°C 10,000 hours +R			Pin	200 to 450	220 to 1,800	
		LXM	Long life, downsized	105°C 7,000 hours +R			Pin	160 to 450	47 to 2,200	
		LXS (Upgrade!)	Long life, downsized	105°C 5,000 hours +R	●		Pin	160 to 500	82 to 3,300	
		LXQ	Long life, downsized	105°C 5,000 hours +R			Pin	160 to 450	82 to 2,700	
		LXG	Long life	105°C 5,000 hours +R			Pin	10 to 100	390 to 47,000	
		CHA	No sparks with DC overvoltage, downsized	105°C 2,000 hours +R			Pin	200 to 450	56 to 1,200	
		LXH	No sparks with DC overvoltage	105°C 3,000/5,000 hours +R			Pin	200 & 400	68 to 1,500	
KMV		For charge and discharge application	105°C 3,000 hours +R			Pin	350 to 450	82 to 1,200		
Screw-Mount Type	General Purpose	SME	85°C, standard (Ask Engineering Bulletin No548 for 160 to 250V)	85°C 2,000 hours +R	●		Screw	10 to 100	2,200 to 680,000	
		KMQ (NEW)	105°C, downsized	105°C 2,000 hours +R			Screw	315 to 450	330 to 10,000	
		KMH	105°C, standard	105°C 2,000 hours +R	●		Screw	10 to 400	180 to 680,000	
	For Inverter	RWH (NEW)	High ripple, downsized	85°C 5,000 hours +R			Screw	350 to 450	3,300 to 18,000	
		RWG	Long life, high ripple, downsized	85°C 5,000 hours +R			Screw	350 to 450	1,500 to 18,000	
		RWF	Long life, high ripple	85°C 5,000 hours +R			Screw	350 to 450	820 to 22,000	
		RWR (NEW)	High ripple, downsized	85°C 2,000 hours +R			Screw	350 to 450	2,700 to 15,000	
		RWQ	High ripple, downsized	85°C 2,000 hours +R	●		Screw	350 to 550	390 to 15,000	
		RWE	High ripple	85°C 2,000 hours +R	●		Screw	350 to 550	100 to 12,000	
		RWY	Long life, high ripple, low cost	85°C 5,000 hours +R			Screw	350 to 450	500 to 14,000	
		RWL	Long life, high ripple	85°C 20,000 hours +R			Screw	350 to 450	2,200 to 12,000	
		FTP	Ellips can shape, high ripple	85°C 5,000 hours +R			Screw	63 to 450	270 to 21,000	
		LXA	105°C, long life	105°C 2,000/5,000 hours +R			Screw	10 to 525	330 to 390,000	
		LXR	105°C, long life, high ripple	105°C 5,000 hours +R			Screw	350 to 450	2,200 to 15,000	
RWV	For charge and discharge application	85°C 5,000 hours +R			Screw	350 to 450	820 to 18,000			

■ : Recommendation products

▲ : Some of range are solvent resistant.

GROUP CHART

☆: Recommendation products

CONDUCTIVE POLYMER ALUMINUM SOLID CAPACITORS

■ SURFACE MOUNT

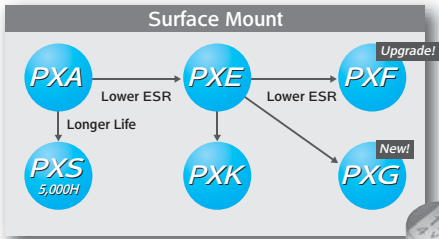

■ RADIAL LEAD

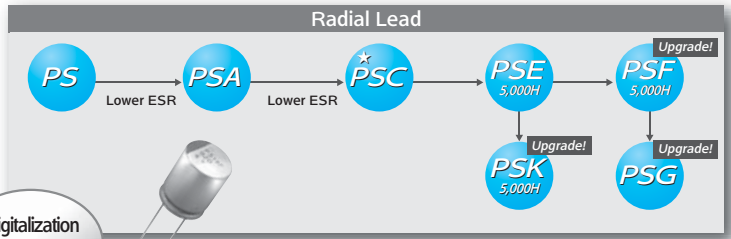

ALUMINUM ELECTROLYTIC CAPACITORS

■ SURFACE MOUNT

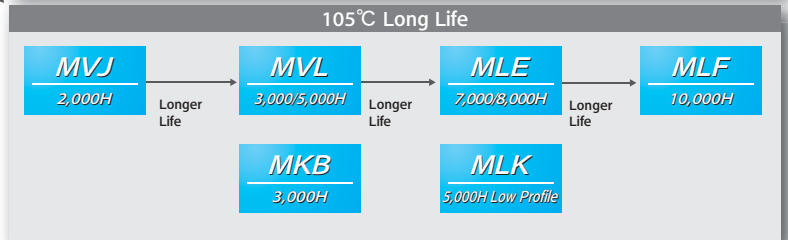
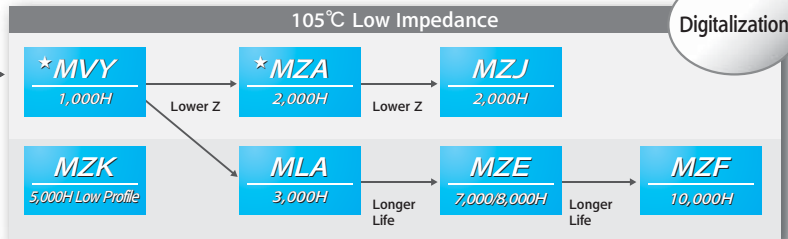
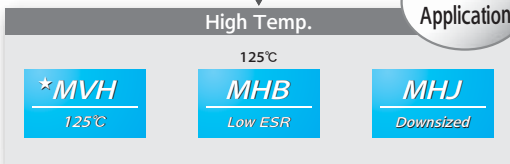
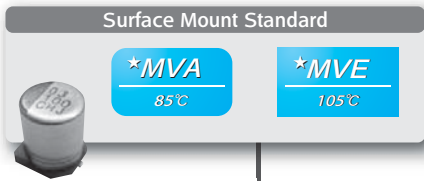

■ RADIAL LEAD

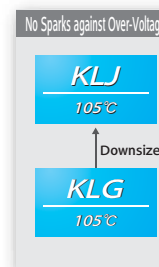
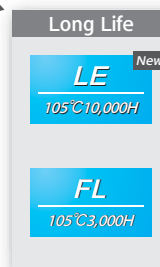
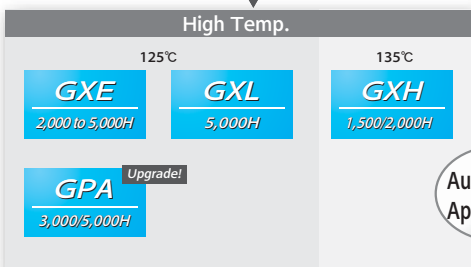
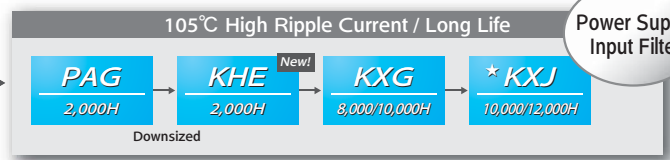
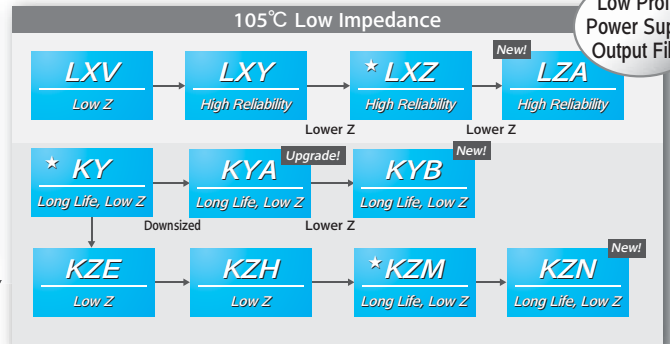
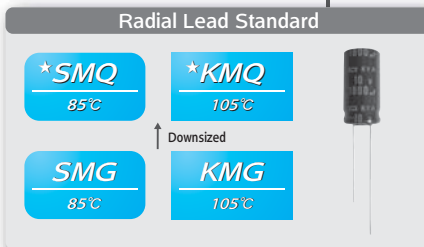
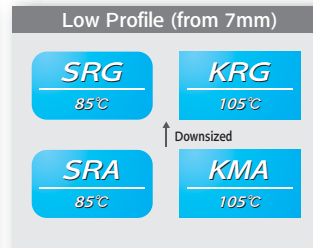
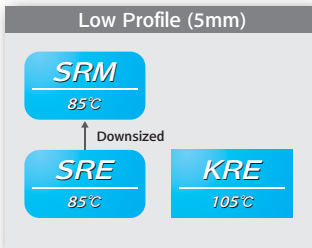

☆ : Recommendation products

ALUMINUM ELECTROLYTIC CAPACITORS

■ SNAP-IN

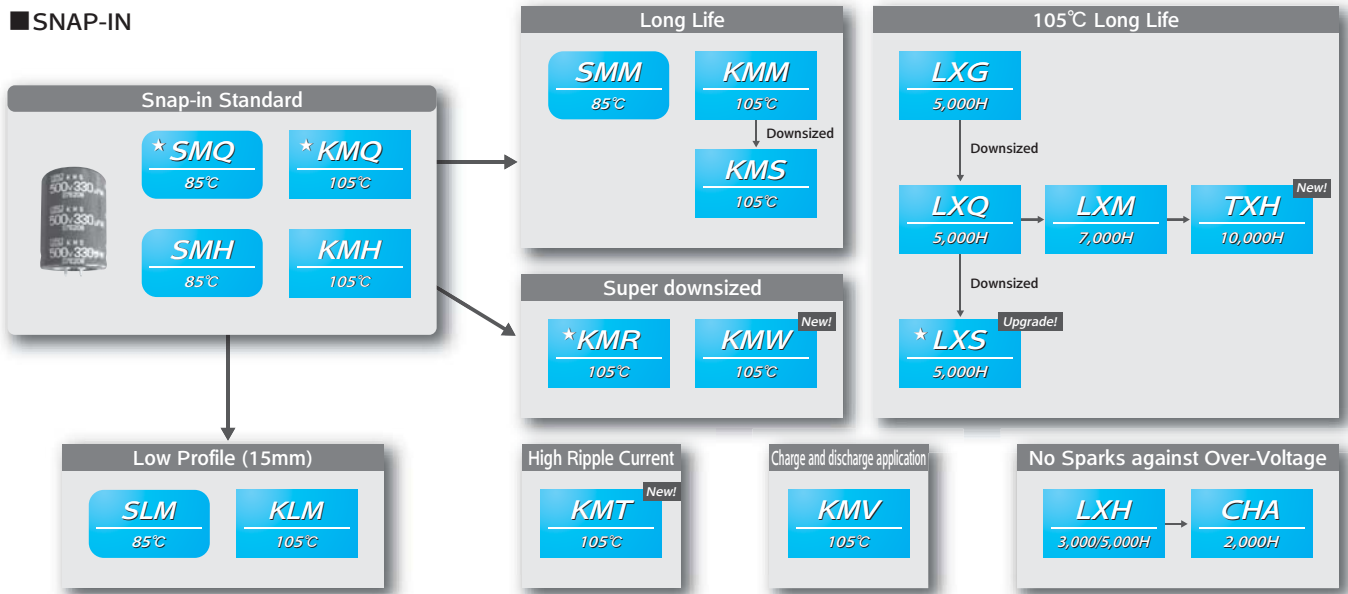

■ SCREW-MOUNT TERMINAL

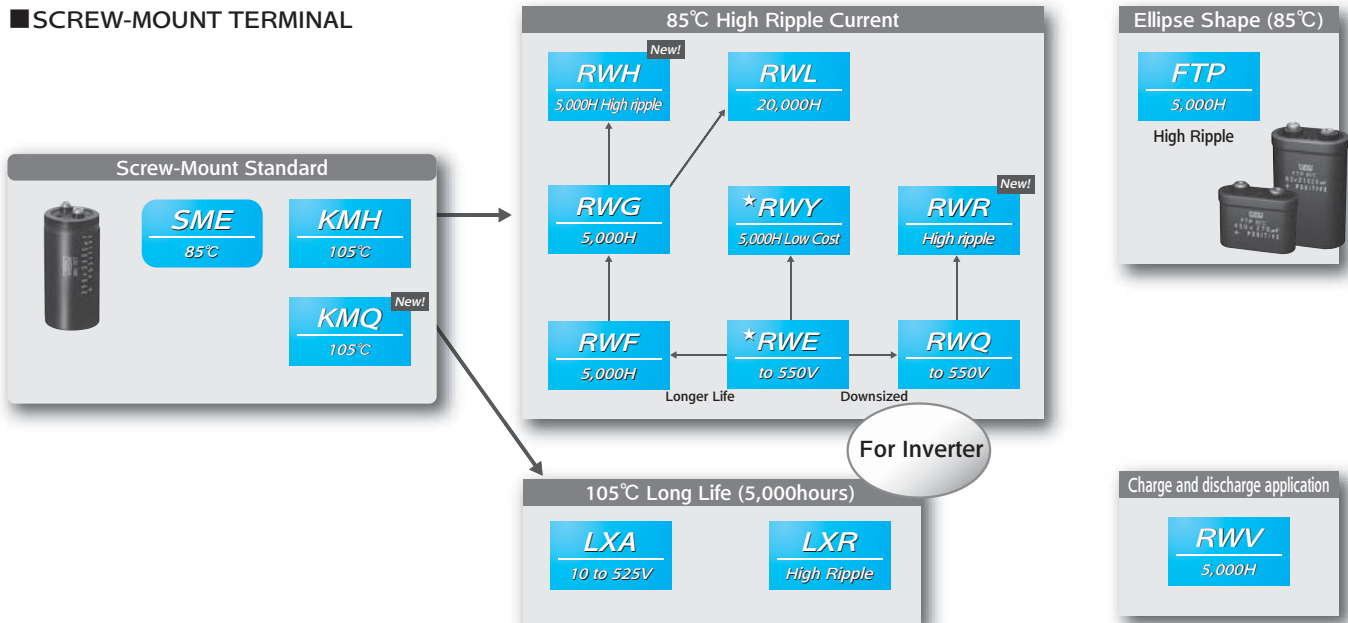



PART NUMBERING SYSTEM

Part numbering system

Our part numbering system is common to all of Nippon Chemi-Con's subsidiaries worldwide, and has been switching the conventional part numbering system. The part number uses 18-digit codes to express information of principal product specifications such as product category, series name, rated voltage, capacitance, case size and RoHS compliance.

●Categories

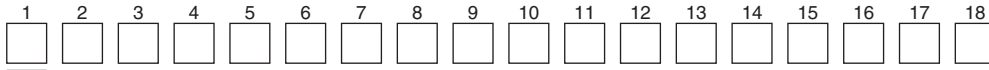

Code	Details
A	Conductive Polymer Aluminum Solid Capacitors (Polar)
E	Aluminum Electrolytic Capacitors (Polar)
B	Aluminum Electrolytic Capacitors (Bi-polar)
K	Multilayer Ceramic Capacitors
F,W	Film Capacitors
D	Electric Double Layer Capacitors
T	Metal Oxide Varistors
L	Amorphous Choke Coils

* For digits 2 to 18, please see "Product code guide".

●Example

Product type	Part number (Example)	Conventional part number (Ref.)
Surface mount type	EMVE160ADA100MD55G	MVE16VC10MD55E0
Radial lead type	EKMQ6R3ETC102MHB5D	TC04RKMQ6.3VB1000MF50E0
Snap-in type	EKMQ201VSN471MP30S	KMQ200VSSN470M22BE0
Screw mount terminal type	ERWE551LGC821MCD0M	RWE550LGSN820MCC13EA



Environment friendly capacitors

Nippon Chemi-Con always considers the environment in product materials, designs and manufacturing. In fact, our factories already have received ISO 14000 certificate. Cadmium, Mercury, Hexavalent Chromium, PBB and PBDE have never been used in our products. Furthermore, lead-containing materials have been eliminated from all our aluminum electrolytic capacitors including Conductive Polymer Aluminum Solid Capacitors to comply with RoHS. If you need "Halogen-Free" products, please consult with us.

◆Lead free and Non-PVC Products

1. Lead wire (Plating)

Category		Plating material on lead wires
Chip	case code : D46 to JA0	Sn-Bi
	case code : KE0 to MN0	Sn
Radial	case dia : ~φ8	Sn-Bi
	case dia : φ10~	Sn
Snap-in		Sn
Screw-Mount		Originally lead-free

*Please consult with us when you need "Lead-free parts" other than the above mentioned terminal plating materials.
(Note) Sn : Tin, Bi : Bismuth

2. Sleeve

Category		Sleeve material
Chip		Sleeveless(Coating case)
Radial	φ8×5L	Sleeveless(Coating case)
	except φ8×5L	PET
Snap-in		PET
Screw-Mount		PVC(Lead-free)

* Please consult with us when you need "Non-PVC parts" other than the above mentioned outer sleeve materials.

The colors of a PET sleeve are "Black", "Brown", and "Dark blue".
Standard designs of "lead-free" Snap-in type are not equipped with a plastic disc.
Please consult with us when you need nonflammable grade for outer sleeve material.

Identification of friendly parts is given by a supplement code (18th digit) of the part number.
For details, please refer to "Product code guide" for each type.

◆Regarding compliance for EU REACH Regulation

1) According to the content of REACH handbook (Guidance on requirements for substances in articles which is published on May 2008), our electronic components are "articles without any intended release". Therefore they are not applicable for "Registration" for EU REACH Regulation Article 7 (1).

Reference: Electrolytic Condenser Investigation Society

"Study of REACH Regulation in EU about Electrolytic Capacitor" (publicized on 13 March 2008)

2) Nippon Chemi-Con develops the products without substance of very high concern(SVHC).DEHP(CASNo.117-81-7) was contained as some covering material, Nippon Chemi-Con abolished use of DEHP totally at June, 2011.

TAPING SPECIFICATIONS

SURFACE MOUNT TYPE (TAPING)



◆CARRIER TAPE [mm]

Fig.1

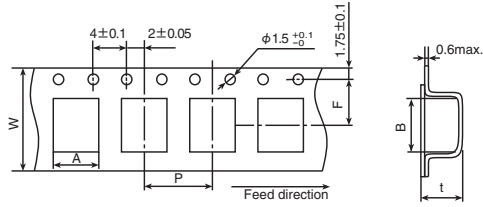

Fig.3

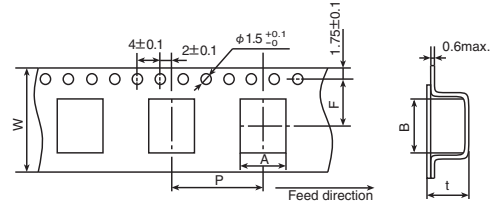

Fig.2

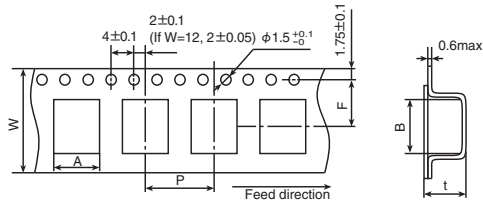
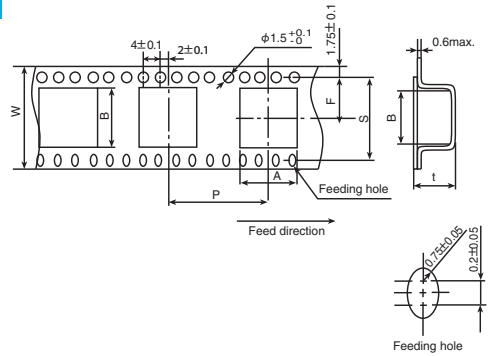

Fig.4



[mm]

Series	Items	W	A	B	F	P	t	S	Fig.	
		±0.3	±0.2	±0.2	±0.1	±0.1	±0.2	±0.1		
Alchip™ MVA/MVE MZJ/MZA MVY/MZF MZE/MZK MLA/MLF MLE/MLK MVL/MVJ MVH/MHB MHJ/MKB MV-BP MVK-BP	D55	12.0	4.7	4.7	5.5	8.0	5.7	—	1	
	D60,D61	12.0	4.7	4.7	5.5	8.0	6.3	—	1	
	D73	12.0	4.6	4.6	5.5	8.0	7.5	—	1	
	E46	12.0	5.7	5.7	5.5	12.0	4.9	—	2	
	E55	12.0	5.7	5.7	5.5	12.0	5.7	—	2	
	E60,E61	12.0	5.7	5.7	5.5	12.0	6.3	—	2	
	E73	16.0	5.7	5.7	7.5	12.0	7.5	—	2	
	F46	16.0	7.0	7.0	7.5	12.0	4.9	—	2	
	F55	16.0	7.0	7.0	7.5	12.0	5.7	—	2	
	F60,F61	16.0	7.0	7.0	7.5	12.0	6.3	—	2	
	F73	16.0	7.0	7.0	7.5	12.0	7.5	—	2	
	F80	16.0	7.0	7.0	7.5	12.0	8.2	—	2	
	F90	16.0	7.0	7.0	7.5	12.0	9.2	—	2	
	H63	16.0	8.7	8.7	7.5	12.0	6.8	—	2	
	H70	24.0	8.7	8.7	11.5	12.0	7.3	—	2	
	H80	24.0	8.7	8.7	11.5	12.0	8.3	—	2	
	HA0	24.0	8.7	8.7	11.5	16.0	11.0	—	3	
	NPCAP™ PXG/PXK PXS/PXF PXE/PXA PXD/PXH	HC0	24.0	8.7	8.7	11.5	16.0	12.7	—	3
		J80	24.0	10.7	10.7	11.5	16.0	8.3	—	3
		JA0	24.0	10.7	10.7	11.5	16.0	11.0	—	3
JC0		24.0	10.7	10.7	11.5	16.0	12.8	—	3	
KE0		32.0	13.4	13.4	14.2	24.0	14.0	28.4	4	
KG5		32.0	13.4	13.4	14.2	24.0	16.5	28.4	4	
LH0		44.0	17.5	17.5	20.2	28.0	16.8	40.4	4	
LNO		44.0	17.5	17.5	20.2	28.0	22.1	40.4	4	
MHO		44.0	19.5	19.5	20.2	32.0	17.1	40.4	4	
MNO		44.0	19.5	19.5	20.2	32.0	22.1	40.4	4	

◆ REEL DIMENSIONS [mm]

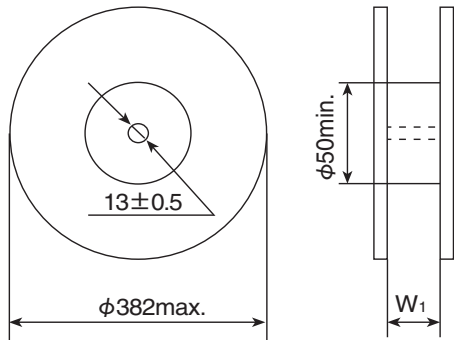

◆ POLARITY

- Alchip™ -MVA/MVE/MZJ
MZA/MVY/MZF
MZE/MZK/MLA
MLF/MLE/MLK
MVL/MVJ/MVH
MHB/MHJ/MKB
MV-BP/MV-K-BP
- NP CAP™ -PXG/PXK/PXS
PXF/PXE/PXA
PXD/PXH

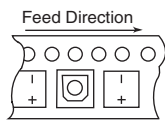

◆ QUANTITY PER REEL/BOX

Series	Size code	Quantity (pcs/reel)	Quantity (pcs/box)	W1 (mm)
Alchip™	D55,D60,D61	2,000	10,000	14
	D73	1,500	7,500	14
	E55,E60,E61	1,000	5,000	14
	F73	1,000	5,000	18
	F55,F60,F61,F73	1,000	5,000	18
	F80	900	4,500	18
	F90	800	4,000	18
	H63	1,000	5,000	18
	HA0	500	1,500	26
	JA0	500	1,500	26
	KE0	200	600	34
	KG5	150	450	34
	LH0	125	250	46
	LN0	75	150	46
	MH0	125	250	46
	MN0	75	150	46
	NPCAP™	D55	2,000	20,000
E46,E60,E61		1,000	10,000	14
F46,F55,F60,F61		1,000	7,000	18
F80		900	6,300	18
H70		1,000	6,000	26
H80		900	5,400	26
HA0		500	3,000	26
HC0		400	1,200	26
J80		500	3,000	26
JA0		500	3,000	26
JC0		400	1,200	26

SURFACE MOUNT TYPE (TRAY)

◆ DIMENSIONS [mm]

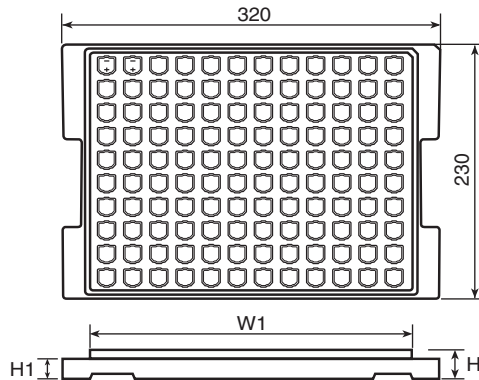

● TRAY CODE : TR

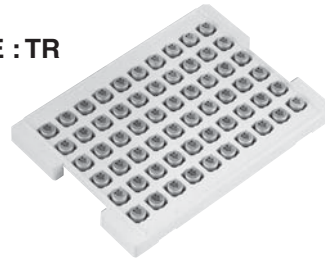

Size code	H [mm]	W1 [mm]	H1 [mm]	Quantity [pcs/tray]	Quantity [pcs/box]
KE0 & KG5	21.0	284	18.5	120	600
LH0 & LN0	28.0	284	24.0	80	400
MH0 & MN0	28.0	284	24.0	60	300

VIBRATION RESISTANT STRUCTURE (Terminal code : G)

◆ DIMENSIONS [mm]

- Terminal code : G
- Size code : HA0 to JA0

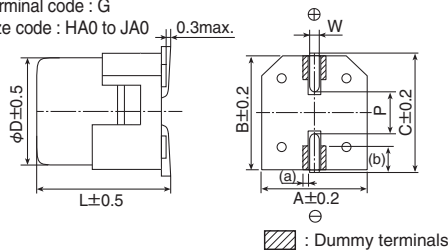

- Size code : KE0 to MN0

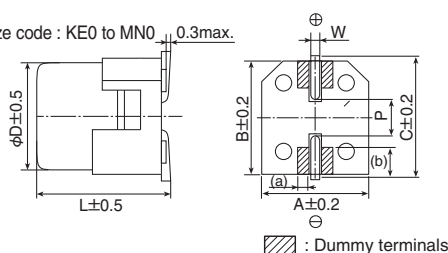

◆ RECOMMENDED SOLDER LAND

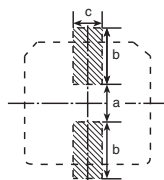

▨ Solder land on PC board

Size code	Dimensions of products (mm)									Solder land (mm)		
	D	L	A	B	C	W	P	(a)	(b)	a	b	c
HA0	8.0	10.0	8.3	8.3	9.0	0.7 to 1.1	3.1	(0.5)	(1.8)	3.1	4.2	3.5
JA0	10.0	10.0	10.3	10.3	11.0	0.7 to 1.1	4.5	(0.5)	(2.1)	4.5	4.4	3.5
KE0	12.5	13.5	13.0	13.0	13.7	1.0 to 1.3	4.2	(1.3)	(3.0)	3.4	6.3	9.3
KG5	12.5	16.0	13.0	13.0	13.7	1.0 to 1.3	4.2	(1.3)	(3.0)	3.4	6.3	9.3
LH0	16.0	16.5	17.0	17.0	18.0	1.0 to 1.3	6.5	(2.0)	(3.0)	4.7	7.8	9.6
LN0	16.0	21.5	17.0	17.0	18.0	1.0 to 1.3	6.5	(2.0)	(3.0)	4.7	7.8	9.6
MH0	18.0	16.5	19.0	19.0	20.0	1.0 to 1.3	6.5	(2.0)	(4.0)	4.7	8.8	9.6
MN0	18.0	21.5	19.0	19.0	20.0	1.0 to 1.3	6.5	(2.0)	(4.0)	4.7	8.8	9.6

() ; Ref.

TAPING SPECIFICATIONS
RADIAL LEAD TYPE (TAPING)



◆ DIMENSION [mm]

Fig.1

Taping Code : TA, TC
φD=φ4 to 8

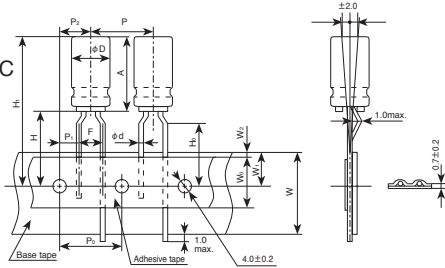

Fig.2

Taping Code : TD
φD=φ5
φD×L=φ4×7

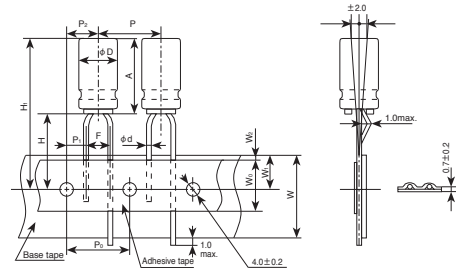

Fig.3

Taping Code : TD
φD=φ6.3 to 12.5

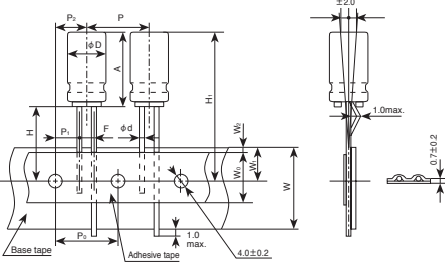
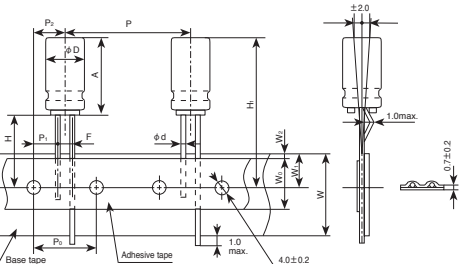

Fig.4

Taping Code : TE
φD=φ12.5



Code	Taping Code	Case size		φd	P	P ₀	P ₁	P ₂	F	W	W ₀	W ₁	W ₂	H	H ₀	H ₁	Fig.
		φD	A														
tol.		—	—	±0.05	±1.0	±0.2	±0.7	±1.0	+0.8 -0.2	±0.5	min.	±0.5	max.	±0.75	±0.5		
Nominal	TA	4	5	0.45	12.7	12.7	5.1 3.85	6.35	2.5 5	18.0	6.0	9.0	1.5	17.5	16.0	H ₁ =H+A Check insertion machine specs.	1
	TC		7	0.45	12.7	12.7	5.1 3.85	6.35	2.5 5	18.0	6.0	9.0	1.5	18.5 ^{*1} 17.5	16.0		2
	TD		11.5	0.45	12.7	12.7	5.1 3.85	6.35	2.5 5	18.0	10.0	9.0	1.5	17.5	16.0		1
	TC																
	TD	5	5 to 7	0.45	12.7	12.7	5.1 3.85	6.35	2.5 5	18.0	6.0	9.0	1.5	18.5 17.5	— 16.0		2
	TC		9 to 15	0.5	12.7	12.7	5.1 3.85	6.35	2.5 5	18.0	10.0	9.0	1.5	18.5 16.0	—		1
	TD																2
	TC																
	TD	6.3	5 to 7	0.45	12.7	12.7	5.1 3.85	6.35	2.5 5	18.0	6.0	9.0	1.5	17.5 16.0	— 16.0		3
	TC		9 to 15	0.5	12.7	12.7	5.1 3.85	6.35	2.5 5	18.0	10.0	9.0	1.5	18.5 16.0	—		1
	TD																3
	TC																
TD	8	5	0.45	12.7	12.7	5.1 3.85	6.35	2.5 5	18.0	6.0	9.0	1.5	18.5 17.5	16.0	3		
TC		7	0.45	12.7	12.7	3.85	6.35	5	18.0	6.0	9.0	1.5	17.5	16.0	1		
TD		9 to 20	0.6	12.7	12.7	4.6 3.85	6.35	3.5 5	18.0	10.0	9.0	1.5	20.0 16.0	—	3		
TC																1	
tol.		±0.5	max.	±0.05	±1.0	±0.3	±0.7	±1.3	+0.8 -0.2	±0.5	min.	±0.5	max.	+2.0 -0	—		
Nominal	TD	10	21	0.6	12.7	12.7	3.85	6.35	5	18.0	12.5	9.0	1.5	18.0	—	3	
	TD	12.5	26	0.6	15 ^{*2}	15	5.0	7.5	5	18.0	12.5	9.0	1.5	18.0	—	3	
	TE			0.6	25.4	12.7	3.85	6.35	5	18.0	12.5	9.0	1.5	18.0	—	4	

* 1 : For φ4×7 (A=7, F=25), shall be 18.5^{-0.5/+0.75} (Taping code : TD) at Fig.2.

* 2 : P=15 taping is not standard. Use P=25.4 taping.

TAPING CODE

Example

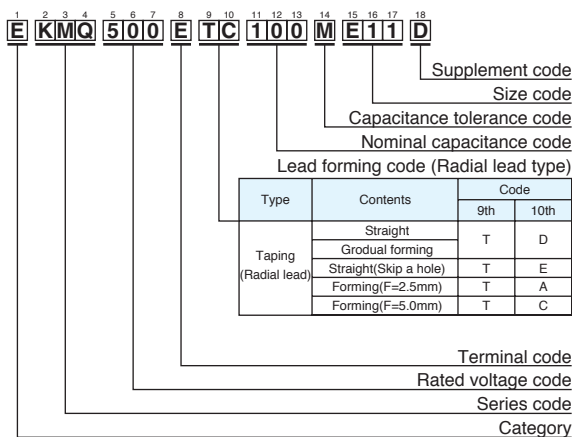

QUANTITY PER AMMO PACK

Ammo pack box

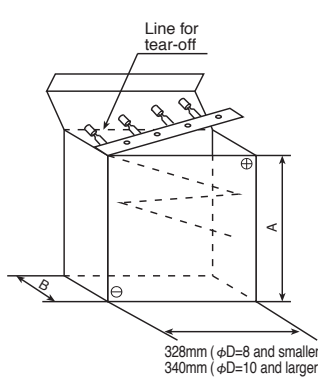

Typical example

Case size φD × L (mm)	A (mm)	B (mm)	Quantity (pcs.)	
φ4	L=5 & 7mm	183	42	2,000
	L=11.5mm	183	51	
φ5	L=5 & 7mm	232	42	2,000
	L=9 to 15mm	232	51	
φ6.3	L=17mm	235	60	2,000
	L=5 & 7mm	282	42	
φ8	L=9 to 15mm	284	51	1,000
	L=17 & 20mm	235	60	
φ10	L=≤16mm	308	56	800(500)*
	L=17 to 20mm	308	62	
	L=21 to 25mm	308	67	
	L=26 to 30mm	308	71	
φ12.5	L=≤16mm	308	62	500
	L=17 to 25mm	308	67	

*Minimum order quantity for PSG/PSK/PSF/PSE/PSC/PSA/PS series

RADIAL LEAD TYPE (CUT/FORMED LEAD)

The following lead configurations are available. When ordering, please indicate the type of lead configurations by using the appropriate supplement code, such as C5, FC, MC or RC in the product part number.

Terminal type	Size	Terminal type	Size
<p>●Lead code : FC (Forming Cut type)</p>	$\phi D=5$ to 8	<p>●Lead code : C5 (Cutting type)</p> <p>Dimension (C)</p> <ul style="list-style-type: none"> • $\phi D= 4$ to 8: $C=5.0 \pm 0.5$ (Second standard $C=3.5 \pm 0.5$) • $\phi D=10$ to 18: $C=5.0 \pm 1.0$ (Second standard $C=3.5 \pm 0.5$) 	$\phi D=4$ to 18
<p>●Lead code : FM (Snap-in type)</p>	$\phi D=5$ to 8	<p>●Lead code : MC (Snap-in type)</p>	$\phi D=10$ to 18
<p>●Lead code : BC (Horizontal type)</p> <p>Dimension (P)</p> <ul style="list-style-type: none"> • $\phi 10, \phi 12.5$: $P=5.0 \pm 0.5$ • $\phi 14.5, \phi 16, \phi 18$: $P=7.5 \pm 0.5$ 	$\phi D=10$ to 18	<p>●Lead code : RC (Snap-in type)</p>	$\phi D=20$ to 22

* Please consult with us the other terminal forming.

◆ DIMENSION (P)

[mm]

Lead forming Size	Cutting type		Snap-in type	
	FC	C5	FM	MC
$\phi 4$	—	1.5	—	—
$\phi 5$	5.0	2.0	5.0	—
$\phi 6.3$	5.0	2.5	5.0	—
$\phi 8$	5L	2.5	5.0	—
	7L min.	5.0	5.0	—
$\phi 10$	—	5.0	—	5.0
$\phi 12.5$	—	5.0	—	5.0
$\phi 14.5$	—	7.5	—	7.5
$\phi 16$	—	7.5	—	7.5
$\phi 18$	—	7.5	—	7.5

* Please refer to dimensions of each series for lead-wire diameter (ϕd).



PACKAGING

MINIMUM ORDER QUANTITY

Please order by minimum order quantity.

◆SURFACE MOUNT

●Vertical



Series	Size code	Quantity (pcs)	
		Taping	Tray (pcs/box)
Alchip™ MVA/MVE/MZJ MZA/MVY/MZF MZE/MZK/MLA MLF/MLE/MLK MVL/MVJ/MVH MHB/MHJ/MKB MV-BP/MVK-BP	D55, D60, D61	2,000	—
	D73	1,500	—
	E46, E55, E60, E61, E73	1,000	—
	F46, F55, F60, F61, F73	1,000	—
	F80, H80	900	—
	F90	800	—
	H63, H70	1,000	—
	HA0	500	—
	HC0	400	—
	J80, JA0	500	—
	JC0	400	—
	KE0	200	600
	KG5	150	600
	LH0	125	400
LN0	75	400	
NPCAP™ PXG/PXK/PXS PXF/PXE/PXA PXD/PXH	MH0	125	300
	MN0	75	300

◆RADIAL



Size	Quantity (pcs)	
	Bagged*1	Taping
φ4	200	2,000
φ5	200	2,000
φ6.3	200 (200)*2	2,000 (2,000)*2
φ8	200 (100)*2	1,000 (1,000)*2
φ10	Height ≤ 25mm	200 (100)*2
	Height ≥ 30mm	200
φ12.5	100	500
φ14.5	50	250
φ16	50	250
φ18	50	250

*1 Standard bagged quantity.

*2 Minimum order quantity for PSG/PSK/PSF/PSE/PSC/PSA/ PS series.

◆SNAP-IN



200 pieces

AVAILABLE TERMINALS FOR SNAP-IN AND SCREW-MOUNT TYPE

- We can make the following terminal type on custom design.
- There is a restriction for specification of product, please consult with us when the product is required.
- Please consult with us about terminal type other than those following listed.

Snap-in type

[mm]

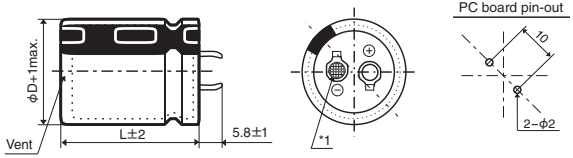
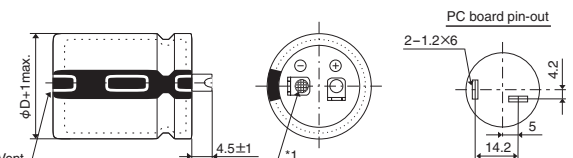
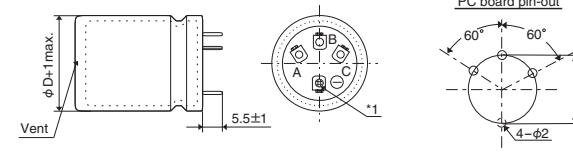
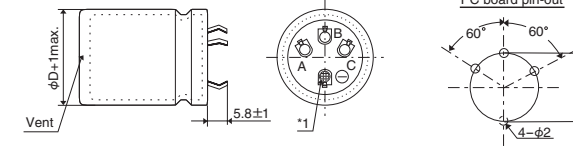
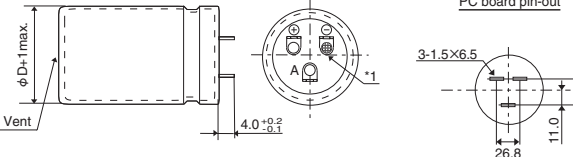
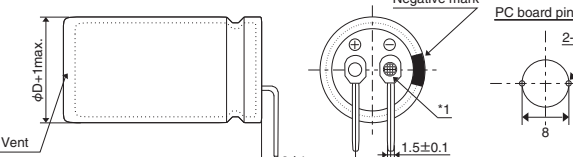
<p>Terminal, Dummy code : VNN</p> <p>D=φ22 to φ35</p> 	<p>Terminal, Dummy code : LIN</p> <p>D=φ30 to φ40</p> 
<p>Terminal, Dummy code : VRD</p> <p>D=φ35, φ40</p>  <p>B : Positive, A, C : Dummy</p>	<p>Terminal, Dummy code : VND</p> <p>D=φ35, φ40</p>  <p>B : Positive, A, C : Dummy</p>
<p>Terminal, Dummy code : LIS</p> <p>D=φ50</p>  <p>A : Dummy</p>	<p>Horizontal mounting Terminal, Dummy code : LCN</p> <p>D=φ20×30 to 50L, φ22×30 to 50L</p> 

*1 Negative terminal : Mesh marking

*2 Use the dummy terminals for mechanical support only.

The dummy terminals must not be connected to any circuit trace on PC board, be sure to electrically isolate from the negative and the positive terminals.

Screw-mount type

[mm]

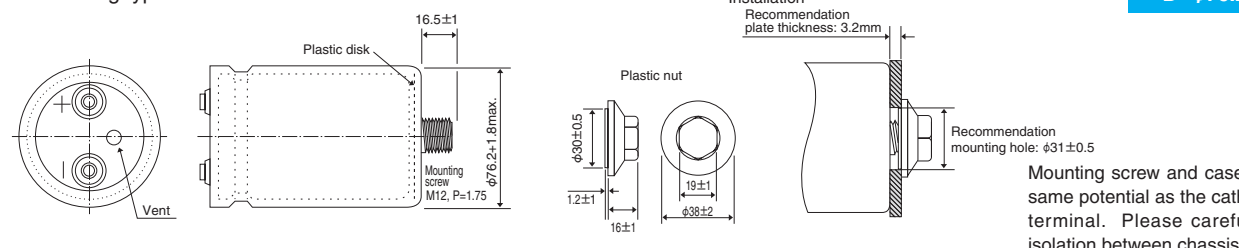
<p>Stud mounting type</p> <p>D=φ76.2</p>  <p>Installation Recommendation plate thickness: 3.2mm</p> <p>Recommendation mounting hole: φ31±0.5</p> <p>Mounting screw and case are same potential as the cathode terminal. Please careful of isolation between chassis.</p>

Please consult with us about other size.

The following series are discontinued. Please use the replacements in the table.

◆CHIP TYPE REPLACEMENTS

Discontinued series	Characteristics	Replacements
MV	85°C standard	MVA
MVK	105°C standard	MVE
MKA		
MVZ	Low impedance	MZA
MLD	Long life	MLE
MZD	Low impedance, Long life	MZE

◆LEAD TYPE REPLACEMENTS

Discontinued series	Characteristics	Replacements
SM	85°C standard	SMG
SME		
KM	105°C standard	KMG
KMC		
KME		
USM		
BSM		
SHA	95°C L=7mm	LXY/LXZ
SM-BP	85°C bi-polar	SME-BP
KM-BP	105°C bi-polar	KME-BP
SRC	85°C low profile	SRG
SXC	Low impedance	KY/LXV
LXE		
LXJ		
SXE		
KMF(6.3 to 100V _{dc})		
LXF	Low impedance	LXY
KMY	Long life	KY
LXA	Long life	KY/LXY
GXD	High heat resistance	GXE
GHA	150°C high heat resistance	*
KMF(160 to 450V _{dc})	High ripple current	KXG
KMX	Long life	
KRL	105°C low leakage current	*

◆SCREW-MOUNT TERMINAL REPLACEMENTS

Discontinued series	Characteristics	Replacements
LWY	105°C long life	LXA/LXR

* Please contact us.

Already been discontinued products are not listed in this catalog.

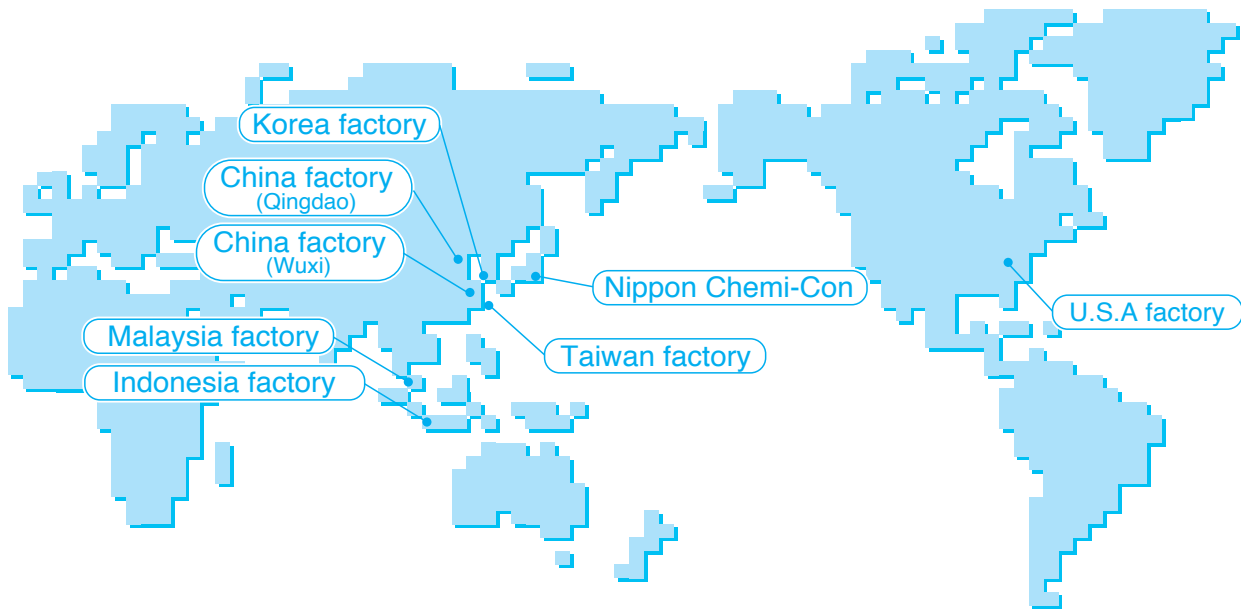

● AVAILABLE ITEMS BY MANUFACTURING LOCATIONS

Classification		Series	Korea factory	China factory (Qingdao)	China factory (Wuxi)	Indonesia factory	Taiwan factory	Malaysia factory	U.S.A. factory
Conductive Polymer Electrolyte Type	SMD	PXE					●		
		PXF					●		
	Radial lead	PSA					●		
		PSC					●		
		PSE					●		
	PSF					●			
SMD	MVA	●		●	●				
	MVE	●		●	●				
	MVY	●		●	●				
	MZA				●				
Radial lead Low Profile	SRE				●				
	SRA				●				
	KMA				●				
	SRG				●				
Radial lead General purpose	SMG	●	●	●	●	●			
	KMG	●	●	●	●	●			
	SMQ			●	●	●			
	KMQ		●	●	●	●			
Radial lead Bi-polar	SME-BP	●	●		●				
	KME-BP	●	●		●				
Radial lead Low impedance, High ripple	LXZ			●	●				
	LXV			●	●	●			
	KY	●	●	●	●	●			
	KZE	●	●	●	●	●			
	KZH			●	●	●			
	KZM			●	●	●			
	KXG			●	●	●			
	KXJ			●	●	●			
PAG			●		●				
Snap-in	SMQ						●	●	
	KMQ						●	●	
	SMM						●	●	
	KMM						●	●	
	KMS						●	●	
Screw-mount Terminal	KMH							●	
	RWE			●				●	
	RWF							●	
	RWL							●	
	LXA							●	

Please be sure to contact us before ordering as our product range is continuously improved and the product you require may have been superseded.

Conductive Polymer Aluminum Solid Capacitors

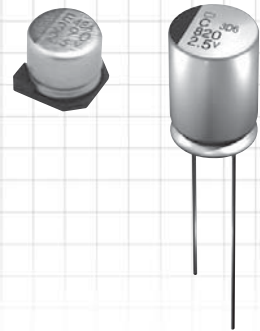

The NPCAP™ is a Conductive Polymer Solid Aluminum Capacitor that uses highly conductive polymer electrolytic material. Please read the following in order to get the most out of your NPCAP™ capacitor.
For aluminum electrolytic capacitors, please refer to PRECAUTIONS AND GUIDELINES.

1 Designing Device Circuits

1) Types of Circuits Where NPCAP™ Capacitors are Not to be Used

The leakage current in conductive polymer solid aluminum capacitors (hereafter called capacitors) may vary depending on thermal stresses during soldering. Avoid the use of capacitors in the following types of circuits:

- ① High-impedance circuits that are to sustain voltages.
- ② Coupling circuits
- ③ Time constant circuits

Because the capacitance varies depending on the environment the capacitors are used in, there is a possibility that the capacitor can affect a time constant circuit where sensitivity to variation in capacitance is required.

- ④ Other circuits that are significantly affected by leakage current

2) Circuit Design

Verify the following before designing the circuit:

- ① The electrical characteristics of the capacitor will vary depending on differences in temperature and frequency. You had better design after verifying the scope of these factors.
- ② When connecting two or more capacitors in parallel, ensure that the design takes current balancing into account.
- ③ When two or more capacitors are connected in series, variability in applied voltage may cause over-voltage conditions. Contact Nippon Chemi-Con before using capacitors connected in series.
- ④ Avoid putting heat generating parts either around the capacitor or on the reverse of the circuit board.

3) Use in High Reliable and Critical Applications

Consult with Nippon Chemi-Con before using these capacitors in applications involving human life: Aviation/space equipment, Nuclear power equipment, Medical equipment and Automotive equipment, or in applications where capacitor failure could have a major impact.

4) Polarity

The NPCAP™ is a polarized solid aluminum electrolytic capacitor. Do not apply either reverse voltages or AC voltages to the polarized capacitors, using reversed polarity may cause a short circuit. Refer to the catalog, product specifications or capacitor body to confirm the polarity prior to use.

5) Operating Voltage

Do not apply a greater than rated voltage, if a voltage greater than the rated voltage is suddenly applied the leakage current increases causing shorting. The peak voltage of superimposed AC voltages (ripple voltages) on DC voltages must not exceed the full rated voltage. While there are specifications for surge voltages exceeding the rated voltage, usage conditions apply, and continued operation for extended periods of time under such conditions cannot be guaranteed.

6) Ripple Current

Do not apply currents in excess of the rated ripple current. The superimposition of a large ripple current increases the rate of heating within the capacitor. When excessive ripple current is imposed the internal temperature increases which can shorten life and shorting may occur.

7) Operating Temperature

Use within the stated category temperature range, if used outside this range, characteristics can deteriorate potentially leading to problems.

8) Charging and Discharging the Capacitor

Do not use the NPCAP™ capacitor in circuits where the capacitor is repetitively charged and discharged rapidly. Repetitive charging and discharging the capacitor rapidly may reduce the capacitance or may cause damage due to internal heating. Use of a protective circuit to ensure reliability is recommended when rush currents exceed 20A.

9) Leakage current

The leakage current may increase when the capacitors are subjected to the conditions below. After that, however, the leakage current will gradually decrease by self-healing action of the dielectric oxide layer when the capacitors are applied with a voltage less than the rated voltage within the Category Temperature range. As the voltage is closer to the rated voltage and the temperature is closer to the upper limit of Category Temperature range, the leakage current decreases faster.

The leakage current will increase by the following factors,

- ① Soldering
- ② Testing of high temperature exposure with no voltage applied, high temperature/humidity storage, temperature cycles, etc.

10) Failures and Service Life

Based on the JIS C 5003 Standard, the failure rate for NPCAP™ capacitors (with a 60% reliability standard) is as follows:

0.5%/1,000 hours (applied the rate voltage at the upper limit of Category Temperature range)

(1) Failure Modes

- ① The principal failure mode is wear-out failure, that is, capacitance decreases and ESR increases, and eventually the capacitors become open circuit failure. In addition, short circuit failure may happen with over-voltage and excessive current applied to the capacitors.
- ② The failure rate would be reduced by reducing ambient temperatures, ripple current and applying voltage.
- ③ If the short-circuited capacitor, which may be caused by over-voltages higher than the rated voltage or other conditions, has a large amount of current passed through, the aluminum can of the capacitor bulges and might be expelled with odor gas emitted.
- ④ The product contains flammable materials. If the short causes a spark it may ignite.

Please be careful when installing the product, its position and the layout design.

- Increase safety by using in conjunction with a protective circuit or protective equipment.
- Install measures such as redundant circuits so that the failure of a part of the equipment will not cause unstable operation.

(2) Service Life

NPCAP™ uses rubber as the sealing material, so the service life depends on the thermal integrity of this rubber. Consequently, it is recommended to use the capacitor at a lower temperature than the maximum temperature for the capacitor category.

11) Capacitor Insulation

Insulation of the capacitor's case is not guaranteed. Ensure electrical insulation between the capacitor case, negative electrode, positive electrode and circuit pattern.

12) Capacitor Usage Environment

Do not use/expose capacitors to the following conditions.

- ① Oil, water, salty water, take care to avoid storage in damp locations.
- ② Direct sunlight
- ③ Toxic gases such as hydrogen, sulfide, sulfurous acids, nitrous acids, chlorine and chlorine compounds, bromine and bromine compounds, ammonia, etc.
- ④ Ozone, ultraviolet rays and radiation.
- ⑤ Severe vibration or mechanical shock conditions beyond the limits advised in the product specification section of the catalog.

13) Capacitor mounting

- ① For the surface mount capacitor, design the solder land on the PC board in accordance with the catalog or the product specification.
- ② For radial capacitors, design the terminal holes on the PC board to fit the terminal dimension of the capacitor.
- ③ Do not pass any circuit traces beneath the seal side of a capacitor. The trace must pass 1 to 2mm to the side of the capacitor.
- ④ Do not pass any via holes underneath a capacitor on double sided PC board
- ⑤ In designing double-sided PC boards, do not locate any copper trace under the seal side of a capacitor

2 | Installing Capacitors

1) Installing

- ① Do not reuse capacitors already assembled in equipment that have been exposed to power.
- ② The capacitor may have self charge. If this happens, discharge the capacitor through a resistor of approximately 1kΩ before use.
- ③ If capacitors are stored at a temperature of 35°C or more and more than 75%RH, the leakage current may increase. This may also occur if the capacitors are stored for a longer period than the period which is specified in the catalog or the product specification. In this case, they can be reformed by the voltage treatment through a resistor of approximately 1kΩ.
- ④ Verify the rated capacitance and voltage of the capacitors when installing.
- ⑤ Verify the polarity of the capacitors.
- ⑥ Do not use the capacitors if they have been dropped on the floor.
- ⑦ Do not deform the case of the capacitors.
- ⑧ Verify that the lead spacing of the capacitor fits the hole spacing in the PC board before installing the capacitors.
- ⑨ Do not apply any mechanical force in excess of the limits prescribed in the catalog or the product specification of the capacitors. Avoid subjecting the capacitor to strong forces, as this may break the electrode terminals, bend or deform the capacitor, or damage the packaging, and may also cause short/open circuits, increased leakage current, or damage the appearance. Also, note the capacitors may be damaged by mechanical shocks caused by cut the lead wire, the vacuum/insertion head, component checker or centering operation of an automatic mounting or insertion machine.

2) Heat Resistance during Soldering

Ensure that the soldering conditions meet the specifications recommended by Nippon Chemi-Con. Note that the leakage current may increase or capacitance may decrease due to thermal stresses that occur during soldering, etc. Furthermore, the leakage current which rose gradually decreases, when voltage is applied at below the category upper limit temperature. Additionally the self repairing action is faster when voltage near the rated voltage rather than at a higher voltage is applied at below the category's upper temperature limit.

- ① Verify the following before using a soldering iron:

- That the soldering conditions (temperature and time) are within the ranges specified in the catalog or product specifications.
 - That the tip of the soldering iron does not come into contact with the capacitor itself.
- ② Verify the following when flow soldering:
 - Do not dip the body of a capacitor into the solder bath only dip the terminals in. The soldering must be done on the reverse side of PC board.
 - Soldering conditions (preheat, solder temperature and dipping time) should be within the limits prescribed in the catalog or the product specifications.
 - Do not apply flux to any part of capacitors other than their terminals.
 - Make sure the capacitors do not come into contact with any other components while soldering.
 - ③ Verify the following when reflow soldering:
 - Soldering conditions (preheat, solder temperature and soldering time) should be within the limits prescribed in the catalogs or the product specification.
 - The heat level should be appropriate. (Note that the thermal stress on the capacitor varies depending on the type and position of the heater in the reflow oven, and the color and material of the capacitor.)
 - Vapor phase soldering (VPS) is not used.
 - Except for the surface mount type, reflow soldering must not be used for the capacitors.
 - ④ Do not reuse a capacitor that has already been soldered to PC board and then removed. When using a new capacitor in the same location, remove the flux, etc. first, and then use a soldering iron to solder on the new capacitor in accordance with the specifications.
 - ⑤ Confirm before running into soldering that the capacitors are SMD for reflow soldering.

3) Handling After Soldering

Do not apply any mechanical stress to the capacitor after soldering onto the PC board.

- ① Do not lean or twist the body of the capacitor after soldering the capacitors onto the PC board.
- ② Do not use the capacitors for lifting or carrying the assembly board.
- ③ Do not hit or poke the capacitor after soldering to PC board. When stacking the assembly board, be careful that other components do not touch the aluminum electrolytic capacitors.
- ④ Do not drop the assembled board.

4) Cleaning PC boards

- ① Do not wash capacitors by using the following cleaning agents. Solvent resistant capacitors are only suitable for washing using the cleaning conditions prescribed in the catalog or the product specification. In particular, ultrasonic cleaning will accelerate damage to capacitors.
 - Halogenated solvents; cause capacitors to fail due to corrosion.
 - Alkali system solvents; corrode (dissolve) an aluminum case.
 - Petroleum system solvents; cause the rubber seal material to deteriorate.
 - Xylene; causes the rubber seal material to deteriorate.
 - Acetone; erases the markings.
 CFC alternatives or the other cleaners above; please consult with us
- ② Verify the following points when washing capacitors.
 - Monitor conductivity, pH, specific gravity and the water content of cleaning agents. Contamination adversely affects these characteristics.
 - Be sure not to expose the capacitors under solvent rich conditions or keep capacitors inside a closed container. In addition, please dry the solvent sufficiently on the PC board and the capacitor with an air knife (temperature

should be less than the maximum rated category temperature of the capacitor) for 10 minutes. Aluminum electrolytic capacitors can be characteristically and catastrophically damaged by halogen ions, particularly by chlorine ions, though the degree of the damage mainly depends upon the characteristics of the electrolyte and rubber seal material. When halogen ions come into contact with the capacitors, the foil corrodes when a voltage is applied. This corrosion causes an extremely high leakage current which results venting and an open circuit.

If the new types of cleaning agents mentioned below are used, the following are recommended as cleaning conditions for some of new cleaning agents.

-Higher alcohol cleaning agents

Pine Alpha ST-100S (Arakawa Chemical)
Clean Through 750 H, 750K, 750L, and 710M (Kao)
Technocare FRW-14 through 17 (Momentive performance material)
Cleaning Conditions:

Using these cleaning agents, capacitors are capable of withstanding immersion or ultrasonic cleaning for 10 minutes at a maximum liquid temperature of 60°C. Find optimum condition for washing, rinsing, and drying. Be sure not to rub the marking off the capacitor which can be caused by contact with other components or the PC board. Note that shower cleaning adversely affects the markings on the sleeve.

-Non-Halogenated Solvent Cleaning

AK225AES (Asahi Glass)
Cleaning Conditions:

Immersion, ultrasonic or vapor cleaning for 5 minutes. However, from an environmental point of view, these types of solvent will be banned in near future. We would recommend not using them if at all possible.

-Isopropyl Alcohol (IPA)

IPA (Isopropyl Alcohol) is one of the most acceptable cleaning agents; it is necessary to maintain a flux content in the cleaning liquid at a maximum limit of 2 Wt.%.

5) Precautions for using adhesives and coating materials

- ① Do not use any adhesive and coating materials containing halogenated solvent.
- ② Verify the following before using adhesive and coating material.
 - Remove flux and dust left over between the rubber seal and the PC board before applying adhesive or coating materials to the capacitor.
 - Dry and remove any residual cleaning agents before applying adhesive and coating materials to the capacitors. Do not cover over the whole surface of the rubber seal with the adhesive or coating materials.
 - For permissible heat conditions for curing adhesives or coating materials, please consult with us.
 - Covering over the whole surface of the capacitor rubber seal with resin may result in a hazardous condition because the inside pressure cannot be completely released. Also, a large amount of halogen ions in resins will cause the capacitors to fail because the halogen ions penetrate into the rubber seal and the inside of the capacitor.
 - Some coating materials, it cannot be implemented to the capacitor.
Please note change on the surface might be caused according to the kind of solvents used for mounting adhesives and coating agents.

6) Fumigation

In many cases when exporting or importing electronic devices, such as capacitors, wooden packaging is used. In order to control insects it may become necessary to fumigate the shipment.

Precautions during “Fumigation” using halogenated chemical such as Methyl Bromide must be taken. Halogen gas can penetrate packaging materials such as cardboard boxes and vinyl bags. Penetration of the halogenated gas can cause corrosion of Electrolytic capacitors. Nippon Chemi-Con gives consideration to the packaging materials not to require the Fumigation. Verify whether the assembled PC board, products and capacitors themselves are subjected to Fumigation during their transportation or not.

3) The Operation of Devices

- 1) Do not touch the capacitor terminals directly.
- 2) Do not short-circuit the terminal of a capacitor by letting it come into contact with any conductive object. Also, do not spill electric-conductive liquid such as acid or alkaline solution over the capacitor.
- 3) Do not use capacitors in circumstances where they would be subject to exposure to the following materials
 - Oil, water, salty water or damp location.
 - Direct sunlight.
 - Ozone, ultraviolet rays or radiation.
 - Toxic gases such as hydrogen sulfide, sulfuric acid, nitrous acid, chlorine or its compounds, and ammonium.
 - Severe vibration or mechanical shock conditions beyond the limits prescribed in the catalog or product specification.

4) Maintenance Inspection

- 1) Make periodic inspections of capacitors that have been used in industrial applications. Before inspection, turn off the power supply and carefully discharge the electricity in the capacitors. Verify the polarity when measuring the capacitors with a volt-ohm meter. Do not apply any mechanical stress to the terminals of the capacitors.
- 2) The following items should be checked during the periodic inspections.
 - ① Significant damage in appearance
 - ② Electrical characteristics: leakage current, capacitance, $\tan \delta$ and other characteristics prescribed in the catalog or product specification.
 We recommend replacing the capacitors if the parts are out of specification.

5) Contingencies

- 1) If gas has vented from the capacitor during use, there is a short circuit and burning, or the capacitor discharges an odor or smoke, turn off the main power supply to the equipment or unplug the power cord.
- 2) If there is a problem with the capacitor or a fire breaks out, the capacitor may produce a burning gas or reactive gas from the outer resin, etc. If this happens, keep your hands and face away from the gas. If vented gas is inhaled or comes into contact with your eyes, flush your eyes immediately with water and/or gargle. If vented gas comes into contact with the skin, wash the affected area thoroughly with soap and water.

6) Storage

We recommend the following conditions for storage.

- 1) Store capacitors in a cool, dry place. Store at a temperature between 5 and 35°C, with a humidity of 75% or less.

(table-1)

	Before the bag is opened	After the bag is opened
SMD	Within 3 years after manufacturing	Within 6 months after the bag is opened
Radial	Within 3 years after manufacturing	—

SMD products are sealed in a special laminated aluminum bag. Use all capacitors once the bag is opened. Return unused capacitors to the bag, and seal it with a zipper. Please refer to (Table -1) for storage conditions. Be sure to follow our recommendations for reflow soldering.

- 2) Store the capacitors in a location free from direct contact with water, salt water, and oil.
- 3) Store in a location where the capacitor is not exposed to toxic gas, such as hydrogen sulfide, sulfurous acid, nitrous acid, chlorine or chlorine compounds, bromine or other halogen gases, methyl bromide or other halogen compounds, ammonia, or similar.
- 4) Store in a location where the capacitor is not exposed to ozone, ultraviolet radiation, or other radiation.
- 5) It is recommended to store capacitors in their original packaging wherever possible.
- 6) The JEDEC J-STD-020 (Rev. C) standard does not apply.

7 Disposal

Please consult with a local industrial waste disposal specialist when disposing of aluminum electrolytic capacitors.

8 Catalogs

Specifications in the catalogs are subject to change without notice. Test data shown in the catalogs are not assured as the whole performance values, but typical values. For more details, refer to JEITA/EIAJ RCR-2367C (March 2006) with the title "Safety Application Guide for fixed aluminum electrolytic capacitors for use in electronic equipment".

9 Regarding compliance for EU REACH Regulation

- 1) According to the content of REACH handbook (Guidance on requirements for substances in articles which is published on May 2008), our electronic components are "articles without any intended release". Therefore they are not applicable for "Registration" for EU REACH Regulation Article 7 (1).
Reference: Electrolytic Condenser Investigation Society
"Study of REACH Regulation in EU about Electrolytic Capacitor"
(publicized on 13 March 2008)
- 2) Nippon Chemi-Con develops the products without substance of very high concern(SVHC).DEHP(CASNo.117-81-7) was contained as some covering material, Nippon Chemi-Con abolished use of DEHP totally at June, 2011.

Product code guide (Conductive polymer Surface mount type)

(Example : PXA series, 4V-150 μ F, ϕ 6.3 \times 5.7L)



Please refer to the following table

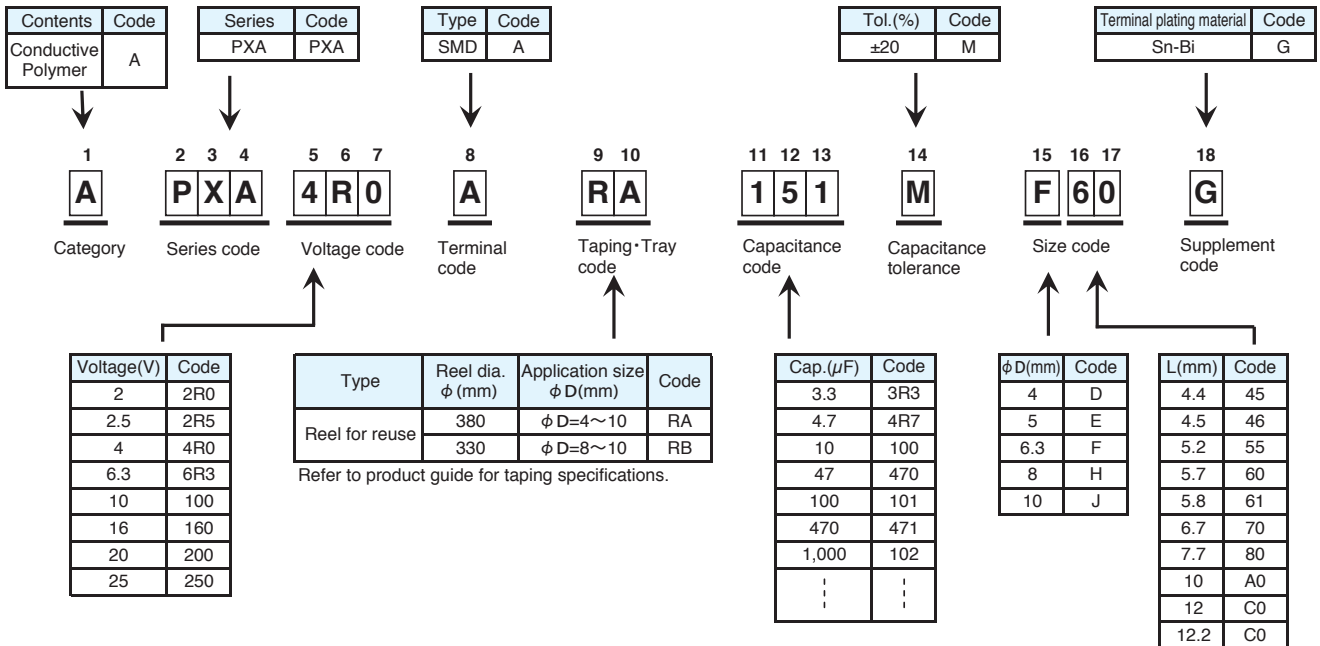

*Refer to the appendix (Part number) for codes not listed here.

Product code guide (Conductive polymer Radial lead type)

(Example : PSC series, 6.3V-470 μ F, ϕ 8 \times 8L, Long Lead with bulk)

Please refer to the following table

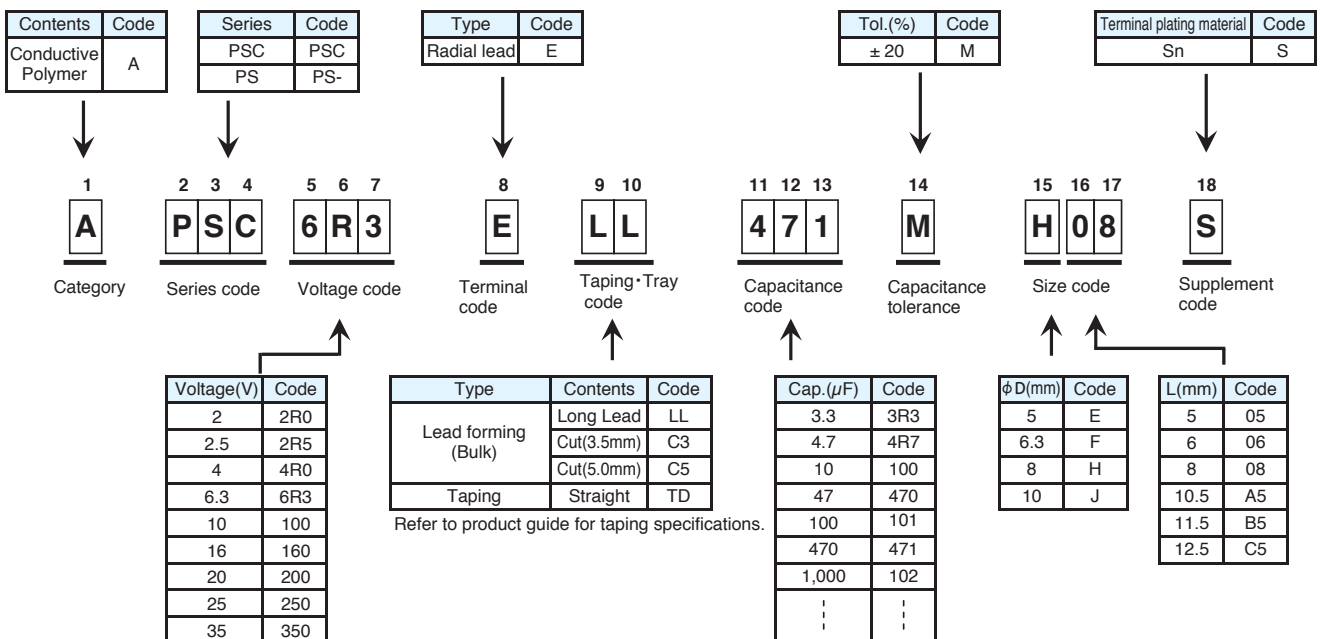

*Refer to the appendix (Part number) for codes not listed here.



CONDUCTIVE POLYMER ALUMINUM SOLID CAPACITORS

CONDUCTIVE POLYMER ALUMINUM SOLID CAPACITORS

Product List

◆SURFACE MOUNT TYPE (2.5 to 10V_{dc})

*1 ESR(mΩ max.)20°C,100k to 300kHz

*2 Rated ripple current(mArms)105°C,100kHz

Cap (μF)	Rated voltage(V _{dc})															
	2.5				4				6.3				10			
	Series	Nominal Case size (φDxL)	ESR *1	Ripple current *2	Series	Nominal Case size (φDxL)	ESR *1	Ripple current *2	Series	Nominal Case size (φDxL)	ESR *1	Ripple current *2	Series	Nominal Case size (φDxL)	ESR *1	Ripple current *2
4.7													PXA	4x5.2	240	670
6.8													PXA	4x5.2	240	670
10													PXA	4x5.2	220	700
15													PXA	4x5.2	200	740
22																
33					PXA	4x5.2	200	740					PXS	5x5.8	70	1100
													PXA	5x5.7	40	1270
47									PXS	5x5.8	30	1970	PXE	5x5.8	28	2310
									PXA	5x5.7	35	1380	PXA	5x5.7	40	1270
													PXA	6.3x4.4	41	1560
													PXA	6.3x5.7	31	2250
													PXD	5x5.8	50	1270
56									PXD	5x5.8	45	1380	PXE	5x5.8	28	2310
													PXA	6.3x5.2	31	2250
													PXA	6.3x5.7	31	2250
													PXD	6.3x5.8	40	2250
													PXH	6.3x5.7	45	2250
68									PXA	6.3x5.7	27	2400	PXS	5x5.8	30	1970
													PXE	5x5.8	28	2310
82									PXA	6.3x4.4	40	1670				
									PXA	6.3x5.2	27	2400				
									PXA	6.3x5.7	27	2400				
									PXH	6.3x5.7	40	2400				
100					PXE	5x5.8	22	2610	PXS	5x5.8	25	2150				
					PXA	6.3x5.2	26	2450	PXE	5x5.8	24	2500				
					PXA	6.3x5.7	26	2450	PXA	5x5.7	35	1380				
									PXA	6.3x4.4	40	1670				
									PXA	6.3x5.2	27	2400				
									PXA	6.3x5.7	27	2400				
									PXD	6.3x5.8	35	2400				
									PXH	6.3x5.7	40	2400				
120	PXD	5x5.8	40	1450	PXA	6.3x4.4	38	1710	PXS	6.3x5.8	22	2570	PXS	6.3x5.8	27	2320
									PXE	5x5.8	24	2500	PXF	5x5.8	22	2600
									PXA	6.3x5.7	27	2400	PXE	6.3x5.8	25	2530
													PXA	8x6.7	27	2800
													PXH	8x6.7	35	2800
150					PXS	5x5.8	25	2150	PXK	6.3x4.5	19	2780	PXS	8x6.7	30	2760
					PXE	5x5.8	22	2610	PXF	5x4.5	25	2100	PXE	6.3x7.7	21	2880
					PXA	5x5.7	30	1490	PXF	5x5.8	12	3500	PXA	8x6.7	27	2800
					PXA	6.3x5.2	26	2450	PXA	8x6.7	25	3020	PXD	8x6.7	35	2800
					PXA	6.3x5.7	26	2450	PXH	8x6.7	30	3020	PXH	8x6.7	35	2800
					PXH	6.3x5.7	35	2450								
180	PXE	5x5.8	21	2670	PXK	6.3x4.5	19	2780	PXK	5x5.8	17	3390				
220	PXK	6.3x4.5	19	2780	PXK	5x5.8	17	3390	PXK	6.3x4.5	18	3200	PXE	8x6.7	21	3220
	PXF	5x4.5	25	2100	PXA	8x6.7	25	3020	PXS	6.3x5.8	22	2570				
	PXA	6.3x5.2	25	2500	PXH	8x6.7	30	3020	PXF	5x5.8	12	3500				
	PXA	6.3x5.7	25	2500					PXF	6.3x5.8	10	3900				
	PXD	6.3x5.8	30	2500					PXE	6.3x5.8	15	3160				
	PXH	6.3x5.7	35	2500					PXA	8x6.7	25	3020				
									PXD	8x6.7	30	3020				
									PXH	8x6.7	30	3020				
270					PXE	6.3x5.8	15	3160	PXF	6.3x7.7	9	4200	PXF	6.3x5.8	20	2800
									PXE	6.3x7.7	14	3470	PXE	8x6.7	21	3220
													PXA	8x12	14	4420
													PXA	10x7.7	24	3770
330	PXK	5x5.8	16	3500	PXF	6.3x5.8	10	3900	PXK	6.3x5.8	17	3390	PXE	8x7.7	19	3390
	PXK	6.3x4.5	16	3500	PXE	6.3x5.8	15	3160	PXF	6.3x5.8	10	3900	PXA	8x12	14	4420
	PXF	5x5.8	10	3900	PXA	8x6.7	25	3020	PXF	6.3x7.7	9	4200	PXA	10x7.7	24	3770
	PXF	6.3x4.4	12	3500					PXF	8x6.7	10	4500	PXD	10x7.7	25	3500
									PXE	6.3x7.7	14	3470	PXH	10x7.7	30	3700
									PXE	8x6.7	14	3950				
									PXA	10x7.7	20	4130				
390	PXF	5x5.8	10	3900	PXK	6.3x5.8	17	3390	PXS	8x6.7	22	3220	PXE	8x10	17	4000
	PXF	6.3x5.8	10	3900	PXF	6.3x7.7	9	4200	PXF	8x6.7	10	4500				
	PXE	6.3x5.8	15	3160	PXE	6.3x7.7	14	3470	PXE	8x6.7	14	3950				
									PXA	8x12	12	4770				
470	PXF	6.3x7.7	9	4200	PXF	8x6.7	10	4500	PXF	8x7.7	9	4500	PXE	10x7.7	19	3800
	PXE	6.3x7.7	13	3600	PXE	8x6.7	14	3950	PXE	8x7.7	13	3950	PXA	10x12.2	12	5300
					PXA	10x7.7	20	4130	PXA	8x12	12	4770				
									PXA	10x7.7	20	4130				
									PXD	10x7.7	25	3500				
									PXH	10x7.7	25	3700				
560	PXK	6.3x5.8	16	3500	PXS	8x6.7	22	3220	PXF	8x7.7	9	4500	PXA	10x12.2	12	5300
	PXF	6.3x5.8	10	3900	PXF	8x6.7	10	4500								
	PXF	6.3x7.7	9	4200	PXE	8x6.7	14	3950								
	PXF	8x6.7	10	4500	PXA	8x12	12	4770								
	PXE	6.3x7.7	13	3600												
	PXE	8x6.7	13	4100												
	PXA	8x6.7	23	3100												
	PXH	8x6.7	30	3100												

Product specifications in this catalog are subject to change without notice. Request our product specifications before purchase and/or use. Please use our products based on the information contained in this catalog and product specifications.



CONDUCTIVE POLYMER ALUMINUM SOLID CAPACITORS

CONDUCTIVE POLYMER ALUMINUM SOLID CAPACITORS

Product List

*1 ESR(mΩ max.)20°C,100k to 300kHz

◆SURFACE MOUNT TYPE (2 to 10V_{dc})

*2 Rated ripple current(mArms)105°C,100kHz

Cap (μF)	Rated voltage(V _{dc})																			
	2				2.5				4				6.3				10			
	Series	Nominal Case size (φD×L)	ESR *1	Ripple current *2	Series	Nominal Case size (φD×L)	ESR *1	Ripple current *2	Series	Nominal Case size (φD×L)	ESR *1	Ripple current *2	Series	Nominal Case size (φD×L)	ESR *1	Ripple current *2	Series	Nominal Case size (φD×L)	ESR *1	Ripple current *2
680	PXF	6.3×5.8	12	3500	PXF	8×6.7	10	4500	PXF	8×7.7	9	4500	PXA	10×12.2	10	5500	PXE	10×10	13	4820
					PXE	8×6.7	13	4100	PXE	8×7.7	13	3950								
					PXA	8×12	12	4770	PXA	10×7.7	20	4130								
									PXH	10×7.7	25	3700								
820					PXE	8×7.7	12	4260	PXA	10×12.2	10	5500	PXE	8×10	12	4770				
					PXE	8×12	9	5400					PXE	8×12	10	5150				
													PXE	10×7.7	14	4300				
													PXA	10×12.2	10	5500				
1000					PXF	8×7.7	9	4500	PXE	8×10	10	5220								
					PXE	8×7.7	12	4260	PXE	10×7.7	14	4300								
					PXA	10×7.7	19	4240												
					PXH	10×7.7	25	3700												
1200					PXE	10×7.7	13	4450	PXE	8×12	9	5400	PXE	10×10	12	5025				
									PXE	10×10	10	5500								
									PXA	10×12.2	10	5500								
1500					PXE	8×10	10	5220	PXE	10×10	10	5500	PXE	10×10	12	5025				
					PXE	8×12	9	5400					PXE	10×12.2	10	5500				
					PXA	10×12.2	10	5500												
1800									PXE	10×10	10	5500								
									PXE	10×12.2	9	5600								
2200					PXE	10×10	10	5500												
2700					PXE	10×12.2	9	5600												

◆SURFACE MOUNT TYPE (16 to 25V_{dc})

Cap (μF)	Rated voltage(V _{dc})															
	16				20				23				25			
	Series	Nominal Case size (φD×L)	ESR *1	Ripple current *2	Series	Nominal Case size (φD×L)	ESR *1	Ripple current *2	Series	Nominal Case size (φD×L)	ESR *1	Ripple current *2	Series	Nominal Case size (φD×L)	ESR *1	Ripple current *2
3.3	PXA	4×5.2	260	660												
10													PXG	5×4.5	60	1700
													PXA	6.3×5.7	65	1500
15					PXA	6.3×4.4	57	1300	PXA	6.3×4.4	57	1300				
22	PXS	5×5.8	90	1060	PXA	6.3×5.2	50	1650					PXG	5×5.8	40	2450
	PXA	5×5.7	45	1210	PXA	6.3×5.7	50	1650					PXG	6.3×4.4	45	2350
	PXA	6.3×4.4	45	1490	PXH	6.3×5.7	60	1650					PXA	8×6.7	50	1800
27					PXG	5×4.5	55	1770					PXG	5×5.8	40	2450
33	PXE	5×5.8	35	2070												
	PXA	6.3×5.7	37	2050												
39	PXG	5×4.5	50	1860	PXA	8×6.7	45	2000					PXG	6.3×5.8	30	2800
	PXS	5×5.8	35	1820									PXA	10×7.7	45	2100
	PXS	6.3×5.8	37	2050												
	PXE	5×5.8	35	2070												
	PXA	6.3×5.2	37	2050												
	PXA	6.3×5.7	37	2050												
	PXH	6.3×5.7	50	2050												
47					PXG	5×5.8	30	2800					PXG	6.3×5.8	30	2800
					PXG	6.3×4.4	42	2400								
					PXA	8×6.7	45	2000								
					PXH	8×6.7	45	2000								
56					PXG	5×5.8	30	2800								
68	PXG	6.3×4.4	40	2450												
	PXS	6.3×5.8	30	2200												
	PXE	6.3×5.8	28	2390												
82	PXS	8×6.7	30	2760	PXA	10×7.7	40	2500								
	PXE	6.3×7.7	24	2700	PXH	10×7.7	45	2400								
	PXA	8×6.7	30	2700												
	PXH	8×6.7	40	2700												
100	PXG	5×5.8	27	3000												
	PXK	6.3×5.8	24	2490												
	PXE	6.3×7.7	24	2700												
	PXE	8×6.7	24	3010												
120	PXS	8×6.7	27	2900	PXG	6.3×5.8	25	3200								
	PXE	8×6.7	24	3010												
150	PXE	8×7.7	22	3150	PXA	10×12.2	20	4320								
	PXA	10×7.7	26	3430												
	PXH	10×7.7	35	3020												
180	PXG	6.3×5.8	22	3300												
	PXE	8×10	18	3890												
	PXA	8×12	16	4360												
	PXA	10×7.7	26	3430												
	PXH	10×7.7	35	3020												
220	PXE	8×10	18	3890												
	PXE	10×7.7	22	3450												
	PXA	10×12.2	14	5050												
330	PXG	8×10	21	3400												
	PXE	10×10	16	4350												
	PXA	10×12.2	14	5050												
820	PXG	10×10	16	4200												



CONDUCTIVE POLYMER ALUMINUM SOLID CAPACITORS

CONDUCTIVE POLYMER ALUMINUM SOLID CAPACITORS

Product List

◆ RADIAL LEAD TYPE (2 to 10V_{dc})

*1 ESR(mΩ max.)20°C,100k to 300kHz

*2 Rated ripple current(mArms)105°C,100kHz

Cap (μF)	Rated voltage(V _{dc})																			
	2				2.5				4				6.3				10			
	Series	Nominal Case size (φDxL)	ESR *1	Ripple *2 current	Series	Nominal Case size (φDxL)	ESR *1	Ripple *2 current	Series	Nominal Case size (φDxL)	ESR *1	Ripple *2 current	Series	Nominal Case size (φDxL)	ESR *1	Ripple *2 current	Series	Nominal Case size (φDxL)	ESR *1	Ripple *2 current
47																	PSA	6.3x10.5	25	2820
68																	PSA	6.3x10.5	25	2820
100																	PSA	6.3x10.5	25	2820
150																	PSA	6.3x10.5	25	2820
220					PSK	5x8	7	4350					PSA	6.3x10.5	20	3160				
270									PSA	6.3x10.5	20	3160	PSK	5x8	10	3700	PSA	8x11.5	9	4710
330					PSK	5x8	7	4350					PSA	6.3x10.5	28	3190	PS	8x11.5	14	4420
390					PSF	6.3x8	5	5900					PSK	5x8	8	4050	PS	8x11.5	14	4420
470					PSA	6.3x10.5	20	3160	PSA	6.3x10.5	24	3300	PSA	8x11.5	8	5080	PSC	8x11.5	9	5650
560					PSF	6.3x8	5	5900	PSF	6.3x8	5	5900	PSA	8x11.5	12	4770	PS	8x11.5	12	4770
680					PSK	5x8	7	4350	PSF	6.3x8	5	5900	PSE	6.3x8	8	4700	PSA	10x11.5	8	5650
820					PSF	6.3x8	5	5900	PSF	6.3x8	5	5900	PSC	8x8	8	5700	PS	10x12.5	12	5300
1000	PSF	6.3x8	5	5900	PSA	6.3x10.5	20	3160	PSA	6.3x10.5	24	3300	PSA	8x11.5	7	5700	PS	8x11.5	12	4770
1200					PSK	5x8	7	4350	PSF	6.3x8	5	5900	PSE	6.3x8	8	4700	PS	10x12.5	12	5300
1500					PSF	6.3x8	5	5900	PSE	6.3x8	7	5000	PSC	8x8	8	5700				
1600					PSC	8x8	7	6100	PSC	8x8	7	6100	PSC	8x8	8	5700				
2700					PSA	8x11.5	7	5580	PSA	8x11.5	7	5580	PS	8x11.5	10	5230	PSA	10x11.5	7	5860
					PS	8x11.5	10	5230	PS	8x11.5	10	5230	PSA	10x11.5	7	5860	PS	10x12.5	10	5500
					PSA	8x11.5	7	5580	PSA	8x11.5	7	5580	PS	10x12.5	10	5500				
					PS	8x11.5	10	5230	PS	8x11.5	10	5230	PS	10x12.5	10	5500				
					PSA	8x11.5	7	5580	PSA	8x11.5	7	5580	PS	10x12.5	10	5500				
					PS	8x11.5	10	5230	PS	8x11.5	10	5230	PS	10x12.5	10	5500				
					PSA	8x11.5	7	5580	PSA	8x11.5	7	5580	PS	10x12.5	10	5500				
					PS	8x11.5	10	5230	PS	8x11.5	10	5230	PS	10x12.5	10	5500				
					PSA	8x11.5	7	5580	PSA	8x11.5	7	5580	PS	10x12.5	10	5500				
					PS	8x11.5	10	5230	PS	8x11.5	10	5230	PS	10x12.5	10	5500				
					PSA	8x11.5	7	5580	PSA	8x11.5	7	5580	PS	10x12.5	10	5500				
					PS	8x11.5	10	5230	PS	8x11.5	10	5230	PS	10x12.5	10	5500				
					PSA	8x11.5	7	5580	PSA	8x11.5	7	5580	PS	10x12.5	10	5500				
					PS	8x11.5	10	5230	PS	8x11.5	10	5230	PS	10x12.5	10	5500				
					PSA	8x11.5	7	5580	PSA	8x11.5	7	5580	PS	10x12.5	10	5500				
					PS	8x11.5	10	5230	PS	8x11.5	10	5230	PS	10x12.5	10	5500				
					PSA	8x11.5	7	5580	PSA	8x11.5	7	5580	PS	10x12.5	10	5500				
					PS	8x11.5	10	5230	PS	8x11.5	10	5230	PS	10x12.5	10	5500				
					PSA	8x11.5	7	5580	PSA	8x11.5	7	5580	PS	10x12.5	10	5500				
					PS	8x11.5	10	5230	PS	8x11.5	10	5230	PS	10x12.5	10	5500				
					PSA	8x11.5	7	5580	PSA	8x11.5	7	5580	PS	10x12.5	10	5500				
					PS	8x11.5	10	5230	PS	8x11.5	10	5230	PS	10x12.5	10	5500				
					PSA	8x11.5	7	5580	PSA	8x11.5	7	5580	PS	10x12.5	10	5500				
					PS	8x11.5	10	5230	PS	8x11.5	10	5230	PS	10x12.5	10	5500				
					PSA	8x11.5	7	5580	PSA	8x11.5	7	5580	PS	10x12.5	10	5500				
					PS	8x11.5	10	5230	PS	8x11.5	10	5230	PS	10x12.5	10	5500				
					PSA	8x11.5	7	5580	PSA	8x11.5	7	5580	PS	10x12.5	10	5500				
					PS	8x11.5	10	5230	PS	8x11.5	10	5230	PS	10x12.5	10	5500				
					PSA	8x11.5	7	5580	PSA	8x11.5	7	5580	PS	10x12.5	10	5500				
					PS	8x11.5	10	5230	PS	8x11.5	10	5230	PS	10x12.5	10	5500				
					PSA	8x11.5	7	5580	PSA	8x11.5	7	5580	PS	10x12.5	10	5500				
					PS	8x11.5	10	5230	PS	8x11.5	10	5230	PS	10x12.5	10	5500				
					PSA	8x11.5	7	5580	PSA	8x11.5	7	5580	PS	10x12.5	10	5500				
					PS	8x11.5	10	5230	PS	8x11.5	10	5230	PS	10x12.5	10	5500				
					PSA	8x11.5	7	5580	PSA	8x11.5	7	5580	PS	10x12.5	10	5500				
					PS	8x11.5	10	5230	PS	8x11.5	10	5230	PS	10x12.5	10	5500				
					PSA	8x11.5	7	5580	PSA	8x11.5	7	5580	PS	10x12.5	10	5500				
					PS	8x11.5	10	5230	PS	8x11.5	10	5230	PS	10x12.5	10	5500				
					PSA	8x11.5	7	5580	PSA	8x11.5	7	5580	PS	10x12.5	10	5500				
					PS	8x11.5	10	5230	PS	8x11.5	10	5230	PS	10x12.5	10	5500				
					PSA	8x11.5	7	5580	PSA	8x11.5	7	5580	PS	10x12.5	10	5500				
					PS	8x11.5	10	5230	PS	8x11.5	10	5230	PS	10x12.5	10	5500				
					PSA	8x11.5	7	5580	PSA	8x11.5	7	5580	PS	10x12.5	10	5500				
					PS	8x11.5	10	5230	PS	8x11.5	10	5230	PS	10x12.5	10	5500				
					PSA	8x11.5	7	5580	PSA	8x11.5	7	5580	PS	10x12.5	10	5500				
					PS	8x11.5	10	5230	PS	8x11.5	10	5230	PS	10x12.5	10	5500				
					PSA	8x11.5	7	5580	PSA	8x11.5	7	5580	PS	10x12.5	10	5500				
					PS	8x11.5	10	5230	PS	8x11.5	10	5230	PS	10x12.5	10	5500				
					PSA	8x11.5	7	5580	PSA	8x11.5	7	5580	PS	10x12.5	10	5500				
					PS	8x11.5	10	5230	PS	8x11.5	10	5230	PS	10x12.5	10	5500				
					PSA	8x11.5	7	5580	PSA	8x11.5	7	5580	PS	10x12.5	10	5500				
					PS	8x11.5	10	5230	PS	8x11.5	10	5230	PS	10x12.5	10	5500				
					PSA	8x11.5	7	5580	PSA	8x11.5	7	5580	PS	10x12.5	10	5500				
					PS	8x11.5	10	5230	PS	8x11.5	10	5230	PS	10x12.5	10	5500				
					PSA	8x11.5	7	5580	PSA	8x11.5	7	5580	PS	10x12.5	10	5500				
					PS	8x11.5	10	5230	PS	8x11.5	10	5230	PS	10x12.5	10	5500				
					PSA	8x11.5	7	5580	PSA	8x11.5	7	5580	PS	10x12.5	10	5500				
					PS	8x11.5	10	5230	PS	8x11.5	10	5230	PS	10x12.5	10	5500				
					PSA	8x11.5	7	5580	PSA	8x11.5	7	5580	PS	10x12.5	10	5500				
					PS	8x11.5	10	5230	PS	8x11.5	10	5230	PS	10x12.5	10	5500				
					PSA	8x11.5	7	5580	PSA	8x11.5	7	5580	PS	10x12.5	10	5500				
					PS	8x11.5	10	5230	PS	8x11.5	10	5230	PS	10x12.5	10	5500				
					PSA	8x11.5	7	5580	PSA	8x11.5	7	5580	PS	10x12.5	10	5500				
					PS	8x11.5	10	5230	PS	8x11.5	10	5230	PS	10x12.5	10	5500				
					PSA	8x11.5	7	5580	PSA	8x11.5	7	5580	PS	10x12.5	10	5500				
					PS	8x11.5	10	5230	PS	8x11.5	10	5230	PS	10x12.5	10	5500				
					PSA	8x11.5	7	5580</												

New!
NPCAP™-P_XG Series

- Super low ESR, high ripple current capability
- Rated voltage range : 16 to 25V_{dc}, Capacitance : 10 to 820μF
- Case size : φ5×4.5L to φ10×10L
- RoHS Compliant
- Halogen Free

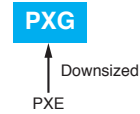

◆ SPECIFICATIONS

Items	Characteristics										
Category											
Temperature Range	-55 to +105°C										
Rated Voltage Range	16 to 25V _{dc}										
Capacitance Tolerance	±20% (M) (at 20°C, 120Hz)										
Surge Voltage	Rated voltage×1.15 (at 105°C)										
Leakage Current	Shall not exceed values shown in STANDARD RATINGS. (at 20°C after 2 minutes)										
Dissipation Factor (tanδ)	0.12 max. (at 20°C, 120Hz)										
Low Temperature Characteristics (Max. Impedance Ratio)	Z(-25°C)/Z(+20°C) ≤ 1.15 Z(-55°C)/Z(+20°C) ≤ 1.25 (at 100kHz)										
Endurance	The following specifications shall be satisfied when the capacitors are restored to 20°C after the rated voltage is applied for 2,000 hours (E46,F45 : 1,000 hours) at 105°C. <table border="1"> <tr><td>Appearance</td><td>No significant damage</td></tr> <tr><td>Capacitance change</td><td>≤ ±20% of the initial value</td></tr> <tr><td>DF (tanδ)</td><td>≤ 150% of the initial specified value</td></tr> <tr><td>ESR</td><td>≤ 150% of the initial specified value</td></tr> <tr><td>Leakage current</td><td>≤ The initial specified value</td></tr> </table>	Appearance	No significant damage	Capacitance change	≤ ±20% of the initial value	DF (tanδ)	≤ 150% of the initial specified value	ESR	≤ 150% of the initial specified value	Leakage current	≤ The initial specified value
Appearance	No significant damage										
Capacitance change	≤ ±20% of the initial value										
DF (tanδ)	≤ 150% of the initial specified value										
ESR	≤ 150% of the initial specified value										
Leakage current	≤ The initial specified value										
Bias Humidity	The following specifications shall be satisfied when the capacitors are restored to 20°C after subjecting them to the DC rated voltage at 60°C, 90 to 95% RH for 1,000 hours (E46,F45 : 500 hours). <table border="1"> <tr><td>Appearance</td><td>No significant damage</td></tr> <tr><td>Capacitance change</td><td>≤ ±20% of the initial value</td></tr> <tr><td>DF (tanδ)</td><td>≤ 150% of the initial specified value</td></tr> <tr><td>ESR</td><td>≤ 150% of the initial specified value</td></tr> <tr><td>Leakage current</td><td>≤ The initial specified value</td></tr> </table>	Appearance	No significant damage	Capacitance change	≤ ±20% of the initial value	DF (tanδ)	≤ 150% of the initial specified value	ESR	≤ 150% of the initial specified value	Leakage current	≤ The initial specified value
Appearance	No significant damage										
Capacitance change	≤ ±20% of the initial value										
DF (tanδ)	≤ 150% of the initial specified value										
ESR	≤ 150% of the initial specified value										
Leakage current	≤ The initial specified value										
Surge Voltage	The capacitors shall be subjected to 1,000 cycles each consisting of charge with the surge voltage specified at 105°C for 30 seconds through a protective resistor (R=1kΩ) and discharge for 5 minutes 30 seconds. <table border="1"> <tr><td>Appearance</td><td>No significant damage</td></tr> <tr><td>Capacitance change</td><td>≤ ±20% of the initial value</td></tr> <tr><td>DF (tanδ)</td><td>≤ 150% of the initial specified value</td></tr> <tr><td>ESR</td><td>≤ 150% of the initial specified value</td></tr> <tr><td>Leakage current</td><td>≤ The initial specified value</td></tr> </table>	Appearance	No significant damage	Capacitance change	≤ ±20% of the initial value	DF (tanδ)	≤ 150% of the initial specified value	ESR	≤ 150% of the initial specified value	Leakage current	≤ The initial specified value
Appearance	No significant damage										
Capacitance change	≤ ±20% of the initial value										
DF (tanδ)	≤ 150% of the initial specified value										
ESR	≤ 150% of the initial specified value										
Leakage current	≤ The initial specified value										
Failure Rate	0.5% per 1,000 hours maximum (Confidence level 60% at 105°C)										

*Note : If any doubt arises, measure the leakage current after the following voltage treatment.
Voltage treatment : DC rated voltage is applied to the capacitors for 120 minutes at 105°C.

◆ DIMENSIONS [mm]

● Terminal Code : A

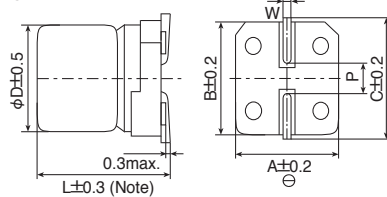

Note : L+0.1/-0.2 for E46 and F45
L±0.5 for HA0 and JA0

Size Code	φD	L	A	B	C	W	P
E46	5	4.5	5.3	5.3	5.9	0.5 to 0.8	1.4
E61	5	5.8	5.3	5.3	5.9	0.5 to 0.8	1.4
F45	6.3	4.4	6.6	6.6	7.2	0.5 to 0.8	1.9
F61	6.3	5.8	6.6	6.6	7.2	0.5 to 0.8	1.9
HA0	8	10.0	8.3	8.3	9.0	0.7 to 1.1	3.1
JA0	10	10.0	10.3	10.3	11.0	0.7 to 1.1	4.5

◆ MARKING



◆ PART NUMBERING SYSTEM

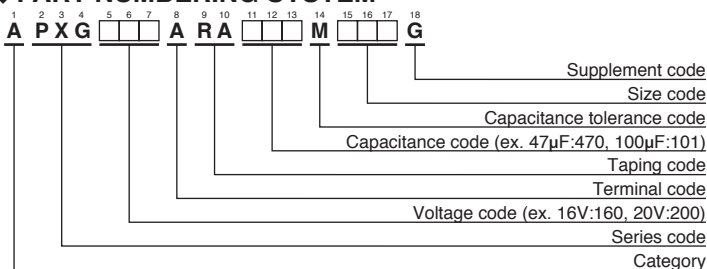

Please refer to "Product code guide (conductive polymer type)"



◆STANDARD RATINGS

WV (Vdc)	Cap (μF)	Size code	Leakage current (μAmax/after 2min.)	ESR (mΩmax/20°C, 100k to 300kHz)	Rated ripple current (mA _{rms} /105°C, 100kHz)	Part No.
16	39	E46	312	50	1,860	APXG160ARA390ME46G
	68	F45	544	40	2,450	APXG160ARA680MF45G
	100	E61	320	27	3,000	APXG160ARA101ME61G
	180	F61	576	22	3,300	APXG160ARA181MF61G
	330	HA0	1,050	21	3,400	APXG160ARA331MHA0G
	820	JA0	2,620	16	4,200	APXG160ARA821MJA0G
20	27	E46	270	55	1,770	APXG200ARA270ME46G
	47	E61	188	30	2,800	APXG200ARA470ME61G
	47	F45	470	42	2,400	APXG200ARA470MF45G
	56	E61	224	30	2,800	APXG200ARA560ME61G
	120	F61	480	25	3,200	APXG200ARA121MF61G
25	10	E46	125	60	1,700	APXG250ARA100ME46G
	22	E61	110	40	2,450	APXG250ARA220ME61G
	22	F45	275	45	2,350	APXG250ARA220MF45G
	27	E61	135	40	2,450	APXG250ARA270ME61G
	39	F61	195	30	2,800	APXG250ARA390MF61G
	47	F61	235	30	2,800	APXG250ARA470MF61G

NPCAP™-PXX Series

- Super low ESR, impedance and high heat resistance have been obtained by using conductive polymer as electrolyte.
- Rated voltage range : 2.5 to 16V_{dc}, Capacitance range : 100 to 560μF
- Suitable for DC-DC converters, voltage regulators and decoupling applications used to computer motherboards etc.
- RoHS Compliant
- Halogen Free

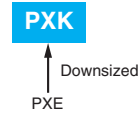

◆ SPECIFICATIONS

Items	Characteristics	
Category		
Temperature Range	-55 to +105°C	
Rated Voltage Range	2.5 to 16V _{dc}	
Capacitance Tolerance	±20% (M) (at 20°C, 120Hz)	
Surge Voltage	Rated voltage × 1.15V (at 105°C)	
Leakage Current	Shall not exceed values shown in STANDARD RATINGS. (at 20°C after 2 minutes)	
Dissipation Factor (tanδ)	0.12 max. (at 20°C, 120Hz)	
Low Temperature Characteristics (Max. Impedance Ratio)	Z(-25°C)/Z(+20°C) ≤ 1.15 Z(-55°C)/Z(+20°C) ≤ 1.25 (at 100kHz)	
Endurance	The following specifications shall be satisfied when the capacitors are restored to 20°C after the rated voltage is applied for 2,000 hours (F46 : 1,000 hours) at 105°C.	
	Appearance	No significant damage
	Capacitance change	≤ ±20% of the initial value
	DF (tanδ)	≤ 150% of the initial specified value
	ESR	≤ 150% of the initial specified value
	Leakage current	≤ The initial specified value
Bias Humidity	The following specifications shall be satisfied when the capacitors are restored to 20°C after subjecting them to the DC rated voltage at 60°C, 90 to 95% RH for 1,000 hours (F46 : 500hours).	
	Appearance	No significant damage
	Capacitance change	≤ ±20% of the initial value
	DF (tanδ)	≤ 150% of the initial specified value
	ESR	≤ 150% of the initial specified value
	Leakage current	≤ The initial specified value
Surge Voltage	The capacitors shall be subjected to 1,000 cycles each consisting of charge with the surge voltage specified at 105°C for 30 seconds through a protective resistor (R=1kΩ) and discharge for 5 minutes 30 seconds.	
	Appearance	No significant damage
	Capacitance change	≤ ±20% of the initial value
	DF (tanδ)	≤ 150% of the initial specified value
	ESR	≤ 150% of the initial specified value
	Leakage current	≤ The initial specified value
Failure Rate	0.5% per 1,000 hours maximum (Confidence level 60% at 105°C)	

*Note : If any doubt arises, measure the leakage current after following voltage treatment.
Voltage treatment : DC rated voltage are applied to the capacitors for 120 minutes at 105°C.

◆ DIMENSIONS [mm]

● Terminal Code : A

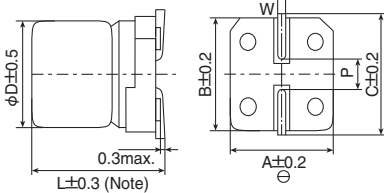

Note : L+0.1/-0.2 for F46

Size Code	φD	L	A	B	C	W	P
E61	5	5.8	5.3	5.3	5.9	0.5 to 0.8	1.4
F46	6.3	4.5	6.6	6.6	7.2	0.5 to 0.8	1.9
F61	6.3	5.8	6.6	6.6	7.2	0.5 to 0.8	1.9

◆ MARKING

EX) 2.5V330μF



◆ PART NUMBERING SYSTEM

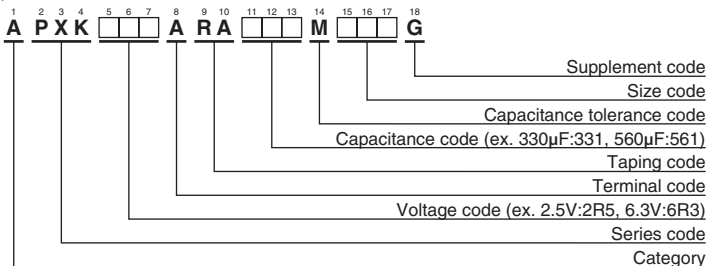

Please refer to "Product code guide (conductive polymer type)"



◆STANDARD RATINGS

WV (Vdc)	Cap (μF)	Size code	Leakage current (μAmax/after 2min.)	ESR (mΩmax/20°C, 100k to 300kHz)	Rated ripple current (mA _{rms} /105°C, 100kHz)	Part No.
2.5	220	F46	300	19	2,780	APXK2R5ARA221MF46G
	330	E61	412	16	3,500	APXK2R5ARA331ME61G
	330	F46	700	16	3,500	APXK2R5ARA331MF46G
	560	F61	700	16	3,500	APXK2R5ARA561MF61G
4	180	F46	360	19	2,780	APXK4R0ARA181MF46G
	220	E61	440	17	3,390	APXK4R0ARA221ME61G
	390	F61	780	17	3,390	APXK4R0ARA391MF61G
6.3	150	F46	472	19	2,780	APXK6R3ARA151MF46G
	180	E61	567	17	3,390	APXK6R3ARA181ME61G
	220	F46	700	18	3,200	APXK6R3ARA221MF46G
	330	F61	1,040	17	3,390	APXK6R3ARA331MF61G
16	100	F61	320	24	2,490	APXK160ARA101MF61G

NPCAP™-PXS Series

- Super low ESR, high ripple current capability
- Longer life (5,000 hours at 105°C)
- Rated voltage range : 4 to 16V_{dc}, Capacitance : 22 to 560μF
- Case size : φ5×5.8L to φ8×6.7L
- Suitable for DC-DC converters, voltage regulators and decoupling applications for computer motherboards etc.
- RoHS Compliant
- Halogen Free

PXS

↑ Longer life
PXE/PXA



◆ SPECIFICATIONS

Items	Characteristics										
Category											
Temperature Range	-55 to +105°C										
Rated Voltage Range	4 to 16V _{dc}										
Capacitance Tolerance	±20% (M) (at 20°C, 120Hz)										
Surge Voltage	Rated voltage×1.15 (at 105°C)										
Leakage Current	I=0.2CV Where, I : Max. leakage current (μA), C : Nominal capacitance (μF), V : Rated voltage (V _{dc}) (at 20°C after 2 minutes)										
Dissipation Factor (tanδ)	0.12 max. (at 20°C, 120Hz)										
Low Temperature Characteristics (Max. Impedance Ratio)	Z(-25°C)/Z(+20°C)≤1.15 Z(-55°C)/Z(+20°C)≤1.25 (at 100kHz)										
Endurance	The following specifications shall be satisfied when the capacitors are restored to 20°C after the rated voltage is applied for 5,000 hours at 105°C. <table border="1"> <tr><td>Appearance</td><td>No significant damage</td></tr> <tr><td>Capacitance change</td><td>≤±20% of the initial value</td></tr> <tr><td>DF (tanδ)</td><td>≤150% of the initial specified value</td></tr> <tr><td>ESR</td><td>≤150% of the initial specified value</td></tr> <tr><td>Leakage current</td><td>≤The initial specified value</td></tr> </table>	Appearance	No significant damage	Capacitance change	≤±20% of the initial value	DF (tanδ)	≤150% of the initial specified value	ESR	≤150% of the initial specified value	Leakage current	≤The initial specified value
Appearance	No significant damage										
Capacitance change	≤±20% of the initial value										
DF (tanδ)	≤150% of the initial specified value										
ESR	≤150% of the initial specified value										
Leakage current	≤The initial specified value										
Bias Humidity	The following specifications shall be satisfied when the capacitors are restored to 20°C after subjecting them to the DC rated voltage at 60°C, 90 to 95% RH for 1,000 hours. <table border="1"> <tr><td>Appearance</td><td>No significant damage</td></tr> <tr><td>Capacitance change</td><td>≤±20% of the initial value</td></tr> <tr><td>DF (tanδ)</td><td>≤150% of the initial specified value</td></tr> <tr><td>ESR</td><td>≤150% of the initial specified value</td></tr> <tr><td>Leakage current</td><td>≤The initial specified value</td></tr> </table>	Appearance	No significant damage	Capacitance change	≤±20% of the initial value	DF (tanδ)	≤150% of the initial specified value	ESR	≤150% of the initial specified value	Leakage current	≤The initial specified value
Appearance	No significant damage										
Capacitance change	≤±20% of the initial value										
DF (tanδ)	≤150% of the initial specified value										
ESR	≤150% of the initial specified value										
Leakage current	≤The initial specified value										
Surge Voltage	The capacitors shall be subjected to 1,000 cycles each consisting of charge with the surge voltage specified at 105°C for 30 seconds through a protective resistor(R=1kΩ)and discharge for 5 minutes 30 seconds. <table border="1"> <tr><td>Appearance</td><td>No significant damage</td></tr> <tr><td>Capacitance change</td><td>≤±20% of the initial value</td></tr> <tr><td>DF (tanδ)</td><td>≤150% of the initial specified value</td></tr> <tr><td>ESR</td><td>≤150% of the initial specified value</td></tr> <tr><td>Leakage current</td><td>≤The initial specified value</td></tr> </table>	Appearance	No significant damage	Capacitance change	≤±20% of the initial value	DF (tanδ)	≤150% of the initial specified value	ESR	≤150% of the initial specified value	Leakage current	≤The initial specified value
Appearance	No significant damage										
Capacitance change	≤±20% of the initial value										
DF (tanδ)	≤150% of the initial specified value										
ESR	≤150% of the initial specified value										
Leakage current	≤The initial specified value										
Failure Rate	0.5% per 1,000 hours maximum (Confidence level 60% at 105°C)										

*Note : If any doubt arises, measure the leakage current after the following voltage treatment.
Voltage treatment : DC rated voltage is applied to the capacitors for 120 minutes at 105°C.

◆ DIMENSIONS [mm]

● Terminal Code : A

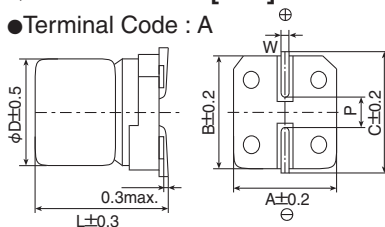

Size Code	φD	L	A	B	C	W	P
E61	5.0	5.8	5.3	5.3	5.9	0.5 to 0.8	1.4
F61	6.3	5.8	6.6	6.6	7.2	0.5 to 0.8	1.9
H70	8.0	6.7	8.3	8.3	9.0	0.7 to 1.1	3.1

◆ MARKING

EX) 6.3V390μF

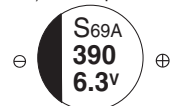

◆ PART NUMBERING SYSTEM

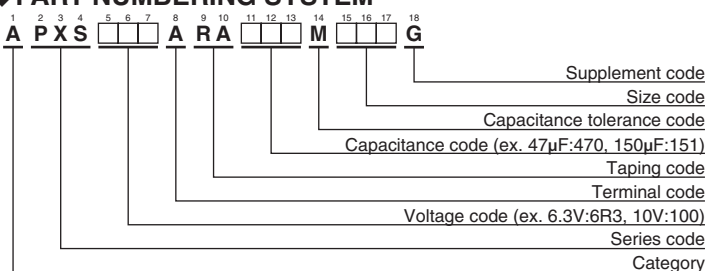

Please refer to "Product code guide (conductive polymer type)"



◆STANDARD RATINGS

WV (Vdc)	Cap (μF)	Size code	ESR (mΩmax/20°C, 100k to 300kHz)	Rated ripple current (mA rms/105°C, 100kHz)	Part No.
4	150	E61	25	2,150	APXS4R0ARA151ME61G
	560	H70	22	3,220	APXS4R0ARA561MH70G
6.3	47	E61	30	1,970	APXS6R3ARA470ME61G
	100	E61	25	2,150	APXS6R3ARA101ME61G
	120	F61	22	2,570	APXS6R3ARA121MF61G
	220	F61	22	2,570	APXS6R3ARA221MF61G
	390	H70	22	3,220	APXS6R3ARA391MH70G
10	33	E61	70	1,100	APXS100ARA330ME61G
	68	E61	30	1,970	APXS100ARA680ME61G
	120	F61	27	2,320	APXS100ARA121MF61G
	150	H70	30	2,760	APXS100ARA151MH70G
16	22	E61	90	1,060	APXS160ARA220ME61G
	39	E61	35	1,820	APXS160ARA390ME61G
	39	F61	37	2,050	APXS160ARA390MF61G
	68	F61	30	2,200	APXS160ARA680MF61G
	82	H70	30	2,760	APXS160ARA820MH70G
	120	H70	27	2,900	APXS160ARA121MH70G

Upgrade!

NPCAP™-PXF Series

- Super low ESR, impedance and high heat resistance have been obtained by using conductive polymer as electrolyte.
- Rated voltage range : 2 to 10V_{dc}, Capacitance range : 120 to 1,000μF
- Case size range : φ5×4.5L to φ8×7.7L
- Suitable for DC-DC converters, voltage regulators and decoupling applications used on computer motherboards etc.
- RoHS Compliant
- Halogen Free

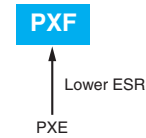

◆ SPECIFICATIONS

Items	Characteristics										
Category	-55 to +105°C										
Temperature Range											
Rated Voltage Range	2 to 10V _{dc}										
Capacitance Tolerance	±20% (M) (at 20°C, 120Hz)										
Surge Voltage	Rated voltage×1.15 (at 105°C)										
Leakage Current	Shall not exceed values shown in STANDARD RATINGS. (at 20°C after 2 minutes)										
Dissipation Factor (tanδ)	0.12 max. (at 20°C, 120Hz)										
Low Temperature Characteristics (Max. Impedance Ratio)	Z(-25°C)/Z(+20°C) ≤ 1.15 Z(-55°C)/Z(+20°C) ≤ 1.15 (at 100kHz)										
Endurance	The following specifications shall be satisfied when the capacitors are restored to 20°C after the rated voltage is applied for 2,000 hours (E46,F45 : 1,000 hours) at 105°C.										
	<table border="1"> <tr> <td>Appearance</td> <td>No significant damage</td> </tr> <tr> <td>Capacitance change</td> <td>≤±20% of the initial value</td> </tr> <tr> <td>DF (tanδ)</td> <td>≤150% of the initial specified value</td> </tr> <tr> <td>ESR</td> <td>≤150% of the initial specified value</td> </tr> <tr> <td>Leakage current</td> <td>≤The initial specified value</td> </tr> </table>	Appearance	No significant damage	Capacitance change	≤±20% of the initial value	DF (tanδ)	≤150% of the initial specified value	ESR	≤150% of the initial specified value	Leakage current	≤The initial specified value
Appearance	No significant damage										
Capacitance change	≤±20% of the initial value										
DF (tanδ)	≤150% of the initial specified value										
ESR	≤150% of the initial specified value										
Leakage current	≤The initial specified value										
Bias Humidity	The following specifications shall be satisfied when the capacitors are restored to 20°C after subjecting them to the DC rated voltage at 60°C, 90 to 95% RH for 1,000 hours (E46,F45 : 500 hours) .										
	<table border="1"> <tr> <td>Appearance</td> <td>No significant damage</td> </tr> <tr> <td>Capacitance change</td> <td>≤±20% of the initial value</td> </tr> <tr> <td>DF (tanδ)</td> <td>≤150% of the initial specified value</td> </tr> <tr> <td>ESR</td> <td>≤150% of the initial specified value</td> </tr> <tr> <td>Leakage current</td> <td>≤The initial specified value</td> </tr> </table>	Appearance	No significant damage	Capacitance change	≤±20% of the initial value	DF (tanδ)	≤150% of the initial specified value	ESR	≤150% of the initial specified value	Leakage current	≤The initial specified value
Appearance	No significant damage										
Capacitance change	≤±20% of the initial value										
DF (tanδ)	≤150% of the initial specified value										
ESR	≤150% of the initial specified value										
Leakage current	≤The initial specified value										
Surge Voltage	The capacitors shall be subjected to 1,000 cycles each consisting of charge with the surge voltage specified at 105°C for 30 seconds through a protective resistor(R=1kΩ) and discharge for 5 minutes 30 seconds.										
	<table border="1"> <tr> <td>Appearance</td> <td>No significant damage</td> </tr> <tr> <td>Capacitance change</td> <td>≤±20% of the initial value</td> </tr> <tr> <td>DF (tanδ)</td> <td>≤150% of the initial specified value</td> </tr> <tr> <td>ESR</td> <td>≤150% of the initial specified value</td> </tr> <tr> <td>Leakage current</td> <td>≤The initial specified value</td> </tr> </table>	Appearance	No significant damage	Capacitance change	≤±20% of the initial value	DF (tanδ)	≤150% of the initial specified value	ESR	≤150% of the initial specified value	Leakage current	≤The initial specified value
Appearance	No significant damage										
Capacitance change	≤±20% of the initial value										
DF (tanδ)	≤150% of the initial specified value										
ESR	≤150% of the initial specified value										
Leakage current	≤The initial specified value										
Failure Rate	0.5% per 1,000 hours maximum (Confidence level 60% at 105°C)										

*Note : If any doubt arises, measure the leakage current after the following voltage treatment.
Voltage treatment : DC rated voltage is applied to the capacitors for 120 minutes at 105°C.

◆ DIMENSIONS [mm]

● Terminal Code : A

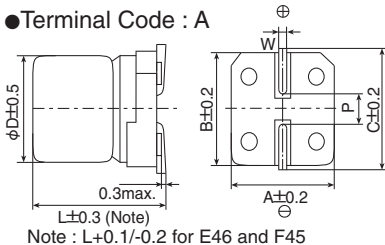

Size Code	φD	L	A	B	C	W	P
E46	5	4.5	5.3	5.3	5.9	0.5 to 0.8	1.4
E61	5	5.8	5.3	5.3	5.9	0.5 to 0.8	1.4
F45	6.3	4.4	6.6	6.6	7.2	0.5 to 0.8	1.9
F61	6.3	5.8	6.6	6.6	7.2	0.5 to 0.8	1.9
F80	6.3	7.7	6.6	6.6	7.2	0.5 to 0.8	1.9
H70	8	6.7	8.3	8.3	9.0	0.7 to 1.1	3.1
H80	8	7.7	8.3	8.3	9.0	0.7 to 1.1	3.1

◆ MARKING

EX) 2.5V390μF



◆ PART NUMBERING SYSTEM

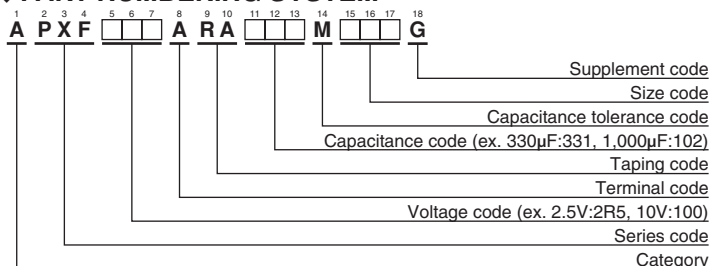

Please refer to "Product code guide (conductive polymer type)"

◆STANDARD RATINGS

WV (Vdc)	Cap (μF)	Size code	Leakage current (μAmax/after 2min.)	ESR (mΩ max/20°C, 100k to 300kHz)	Rated ripple current (mA _{rms} /105°C, 100kHz)	Part No.
2	680	F61	700	12	3,500	APXF2R0ARA681MF61G
	220	E46	700	25	2,100	APXF2R5ARA221ME46G
2.5	330	E61	700	10	3,900	APXF2R5ARA331ME61G
	330	F45	700	12	3,500	APXF2R5ARA331MF45G
	390	E61	700	10	3,900	APXF2R5ARA391ME61G
	390	F61	292	10	3,900	APXF2R5ARA391MF61G
	470	F80	352	9	4,200	APXF2R5ARA471MF80G
	560	F61	700	10	3,900	APXF2R5ARA561MF61G
	560	F80	420	9	4,200	APXF2R5ARA561MF80G
	560	H70	420	10	4,500	APXF2R5ARA561MH70G
	680	H70	510	10	4,500	APXF2R5ARA681MH70G
	1,000	H80	750	9	4,500	APXF2R5ARA102MH80G
4	330	F61	396	10	3,900	APXF4R0ARA331MF61G
	390	F80	468	9	4,200	APXF4R0ARA391MF80G
	470	H70	564	10	4,500	APXF4R0ARA471MH70G
	560	H70	672	10	4,500	APXF4R0ARA561MH70G
	680	H80	816	9	4,500	APXF4R0ARA681MH80G
6.3	150	E46	700	25	2,100	APXF6R3ARA151ME46G
	150	E61	700	12	3,500	APXF6R3ARA151ME61G
	220	E61	700	12	3,500	APXF6R3ARA221ME61G
	220	F61	415	10	3,900	APXF6R3ARA221MF61G
	270	F80	510	9	4,200	APXF6R3ARA271MF80G
	330	F61	700	10	3,900	APXF6R3ARA331MF61G
	330	F80	623	9	4,200	APXF6R3ARA331MF80G
	330	H70	623	10	4,500	APXF6R3ARA331MH70G
	390	H70	737	10	4,500	APXF6R3ARA391MH70G
	470	H80	888	9	4,500	APXF6R3ARA471MH80G
	560	H80	1,050	9	4,500	APXF6R3ARA561MH80G
10	120	E61	240	22	2,600	APXF100ARA121ME61G
	270	F61	540	20	2,800	APXF100ARA271MF61G

NPCAP™-PXE Series

- Super low ESR, impedance and high heat resistance have been obtained by using conductive polymer as electrolyte.
(ESR and rated ripple current values are improved from PXA series.)
- Rated voltage range : 2.5 to 16V_{dc}, Capacitance range : 33 to 2,700μF
- Suitable for DC-DC converters, voltage regulators and decoupling applications used on computer motherboards etc.
- RoHS Compliant
- Halogen Free

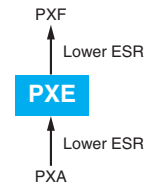

◆ SPECIFICATIONS

Items	Characteristics										
Category											
Temperature Range	-55 to +105°C										
Rated Voltage Range	2.5 to 16V _{dc}										
Capacitance Tolerance	±20% (M) (at 20°C, 120Hz)										
Surge Voltage	Rated voltage × 1.15 (at 105°C)										
Leakage Current	Shall not exceed values shown in STANDARD RATINGS. (at 20°C after 2 minutes)										
Dissipation Factor (tanδ)	0.12 max. (at 20°C, 120Hz)										
Low Temperature Characteristics (Max. Impedance Ratio)	Z(-25°C)/Z(+20°C) ≤ 1.15 Z(-55°C)/Z(+20°C) ≤ 1.25 (at 100kHz)										
Endurance	The following specifications shall be satisfied when the capacitors are restored to 20°C after the rated voltage is applied for 2,000 hours at 105°C.										
	<table border="1"> <tr><td>Appearance</td><td>No significant damage</td></tr> <tr><td>Capacitance change</td><td>≤ ±20% of the initial value</td></tr> <tr><td>DF (tanδ)</td><td>≤ 150% of the initial specified value</td></tr> <tr><td>ESR</td><td>≤ 150% of the initial specified value</td></tr> <tr><td>Leakage current</td><td>≤ The initial specified value</td></tr> </table>	Appearance	No significant damage	Capacitance change	≤ ±20% of the initial value	DF (tanδ)	≤ 150% of the initial specified value	ESR	≤ 150% of the initial specified value	Leakage current	≤ The initial specified value
Appearance	No significant damage										
Capacitance change	≤ ±20% of the initial value										
DF (tanδ)	≤ 150% of the initial specified value										
ESR	≤ 150% of the initial specified value										
Leakage current	≤ The initial specified value										
Bias Humidity	The following specifications shall be satisfied when the capacitors are restored to 20°C after subjecting them to the DC rated voltage at 60°C, 90 to 95% RH for 1,000 hours.										
	<table border="1"> <tr><td>Appearance</td><td>No significant damage</td></tr> <tr><td>Capacitance change</td><td>≤ ±20% of the initial value</td></tr> <tr><td>DF (tanδ)</td><td>≤ 150% of the initial specified value</td></tr> <tr><td>ESR</td><td>≤ 150% of the initial specified value</td></tr> <tr><td>Leakage current</td><td>≤ The initial specified value</td></tr> </table>	Appearance	No significant damage	Capacitance change	≤ ±20% of the initial value	DF (tanδ)	≤ 150% of the initial specified value	ESR	≤ 150% of the initial specified value	Leakage current	≤ The initial specified value
Appearance	No significant damage										
Capacitance change	≤ ±20% of the initial value										
DF (tanδ)	≤ 150% of the initial specified value										
ESR	≤ 150% of the initial specified value										
Leakage current	≤ The initial specified value										
Surge Voltage	The capacitors shall be subjected to 1,000 cycles each consisting of charge with the surge voltage specified at 105°C for 30 seconds through a protective resistor (R=1kΩ) and discharge for 5 minutes 30 seconds.										
	<table border="1"> <tr><td>Appearance</td><td>No significant damage</td></tr> <tr><td>Capacitance change</td><td>≤ ±20% of the initial value</td></tr> <tr><td>DF (tanδ)</td><td>≤ 150% of the initial specified value</td></tr> <tr><td>ESR</td><td>≤ 150% of the initial specified value</td></tr> <tr><td>Leakage current</td><td>≤ The initial specified value</td></tr> </table>	Appearance	No significant damage	Capacitance change	≤ ±20% of the initial value	DF (tanδ)	≤ 150% of the initial specified value	ESR	≤ 150% of the initial specified value	Leakage current	≤ The initial specified value
Appearance	No significant damage										
Capacitance change	≤ ±20% of the initial value										
DF (tanδ)	≤ 150% of the initial specified value										
ESR	≤ 150% of the initial specified value										
Leakage current	≤ The initial specified value										
Failure Rate	0.5% per 1,000 hours maximum (Confidence level 60% at 105°C)										

*Note : If any doubt arises, measure the leakage current after the following voltage treatment.
Voltage treatment : DC rated voltage is applied to the capacitors for 120 minutes at 105°C.

◆ DIMENSIONS [mm]

● Terminal Code : A

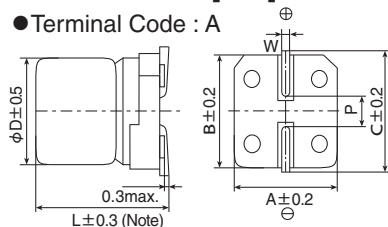

(Note) L ± 0.5 for HA0, HC0, JA0, JC0

Size Code	φD	L	A	B	C	W	P
E61	5	5.8	5.3	5.3	5.9	0.5 to 0.8	1.4
F61	6.3	5.8	6.6	6.6	7.2	0.5 to 0.8	1.9
F80	6.3	7.7	6.6	6.6	7.2	0.5 to 0.8	1.9
H70	8	6.7	8.3	8.3	9.0	0.7 to 1.1	3.1
H80	8	7.7	8.3	8.3	9.0	0.7 to 1.1	3.1
HA0	8	10.0	8.3	8.3	9.0	0.7 to 1.1	3.1
HC0	8	12.0	8.3	8.3	9.0	0.7 to 1.1	3.1
J80	10	7.7	10.3	10.3	11.0	0.7 to 1.1	4.5
JA0	10	10.0	10.3	10.3	11.0	0.7 to 1.1	4.5
JC0	10	12.2	10.3	10.3	11.0	0.7 to 1.1	4.5

◆ MARKING

EX) 2.5V390μF



◆ PART NUMBERING SYSTEM

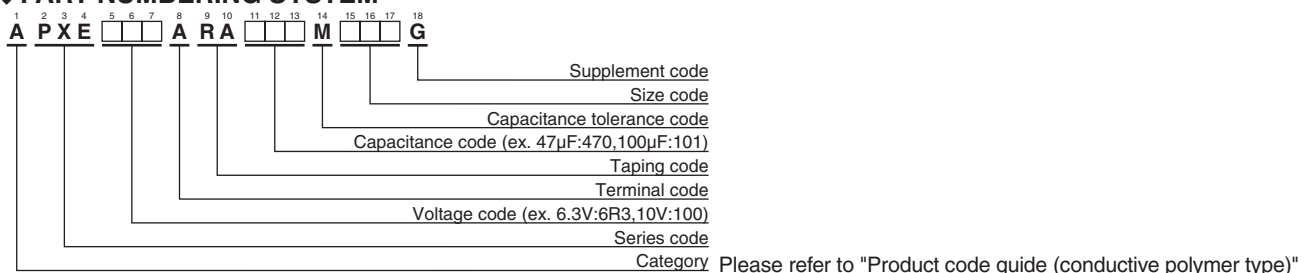

◆STANDARD RATINGS

WV (Vdc)	Cap (μF)	Size code	Leakage current (μAmax/after 2min.)	ESR (mΩmax/20°C, 100k to 300kHz)	Rated ripple current (mArms/105°C, 100kHz)	Part No.
2.5	180	E61	90.0	21	2,670	APXE2R5ARA181ME61G
	390	F61	195	15	3,160	APXE2R5ARA391MF61G
	470	F80	235	13	3,600	APXE2R5ARA471MF80G
	560	F80	280	13	3,600	APXE2R5ARA561MF80G
	560	H70	280	13	4,100	APXE2R5ARA561MH70G
	680	H70	340	13	4,100	APXE2R5ARA681MH70G
	820	H80	410	12	4,260	APXE2R5ARA821MH80G
	820	HC0	410	9	5,400	APXE2R5ARA821MHC0G
	1,000	H80	500	12	4,260	APXE2R5ARA102MH80G
	1,200	J80	600	13	4,450	APXE2R5ARA122MJ80G
	1,500	HA0	750	10	5,220	APXE2R5ARA152MHA0G
	1,500	HC0	750	9	5,400	APXE2R5ARA152MHC0G
	2,200	JA0	1,100	10	5,500	APXE2R5ARA222MJA0G
2,700	JC0	1,350	9	5,600	APXE2R5ARA272MJC0G	
4	100	E61	80.0	22	2,610	APXE4R0ARA101ME61G
	150	E61	120	22	2,610	APXE4R0ARA151ME61G
	270	F61	216	15	3,160	APXE4R0ARA271MF61G
	330	F61	264	15	3,160	APXE4R0ARA331MF61G
	390	F80	312	14	3,470	APXE4R0ARA391MF80G
	470	H70	376	14	3,950	APXE4R0ARA471MH70G
	560	H70	448	14	3,950	APXE4R0ARA561MH70G
	680	H80	544	13	3,950	APXE4R0ARA681MH80G
	1,000	HA0	800	10	5,220	APXE4R0ARA102MHA0G
	1,000	J80	800	14	4,300	APXE4R0ARA102MJ80G
	1,200	HC0	960	9	5,400	APXE4R0ARA122MHC0G
	1,200	JA0	960	10	5,500	APXE4R0ARA122MJA0G
	1,500	JA0	1,200	10	5,500	APXE4R0ARA152MJA0G
1,800	JA0	1,440	10	5,500	APXE4R0ARA182MJA0G	
1,800	JC0	1,440	9	5,600	APXE4R0ARA182MJC0G	
6.3	100	E61	126	24	2,500	APXE6R3ARA101ME61G
	120	E61	151	24	2,500	APXE6R3ARA121ME61G
	220	F61	277	15	3,160	APXE6R3ARA221MF61G
	270	F80	340	14	3,470	APXE6R3ARA271MF80G
	330	F80	415	14	3,470	APXE6R3ARA331MF80G
	330	H70	415	14	3,950	APXE6R3ARA331MH70G
	390	H70	491	14	3,950	APXE6R3ARA391MH70G
	470	H80	592	13	3,950	APXE6R3ARA471MH80G
	820	HA0	1,030	12	4,770	APXE6R3ARA821MHA0G
	820	HC0	1,030	10	5,150	APXE6R3ARA821MHC0G
	820	J80	1,030	14	4,300	APXE6R3ARA821MJ80G
	1,200	JA0	1,510	12	5,025	APXE6R3ARA122MJA0G
	1,500	JA0	1,890	12	5,025	APXE6R3ARA152MJA0G
1,500	JC0	1,890	10	5,500	APXE6R3ARA152MJC0G	
10	47	E61	94.0	28	2,310	APXE100ARA470ME61G
	56	E61	112	28	2,310	APXE100ARA560ME61G
	68	E61	136	28	2,310	APXE100ARA680ME61G
	120	F61	240	25	2,530	APXE100ARA121MF61G
	150	F80	300	21	2,880	APXE100ARA151MF80G
	220	H70	440	21	3,220	APXE100ARA221MH70G
	270	H70	540	21	3,220	APXE100ARA271MH70G
	330	H80	660	19	3,390	APXE100ARA331MH80G
	390	HA0	780	17	4,000	APXE100ARA391MHA0G
	470	J80	940	19	3,800	APXE100ARA471MJ80G
680	JA0	1,360	13	4,820	APXE100ARA681MJA0G	
16	33	E61	105	35	2,070	APXE160ARA330ME61G
	39	E61	124	35	2,070	APXE160ARA390ME61G
	68	F61	217	28	2,390	APXE160ARA680MF61G
	82	F80	262	24	2,700	APXE160ARA820MF80G
	100	F80	320	24	2,700	APXE160ARA101MF80G
	100	H70	320	24	3,010	APXE160ARA101MH70G
	120	H70	384	24	3,010	APXE160ARA121MH70G
	150	H80	480	22	3,150	APXE160ARA151MH80G
	180	HA0	576	18	3,890	APXE160ARA181MHA0G
	220	HA0	704	18	3,890	APXE160ARA221MHA0G
	220	J80	704	22	3,450	APXE160ARA221MJ80G
330	JA0	1,050	16	4,350	APXE160ARA331MJA0G	

NPCAP™-PXA Series

- Super low ESR, impedance and high heat resistance have been obtained by using conductive polymer as electrolyte
- Rated voltage range : 2.5 to 25V_{dc}, case size range : φ4×5.2L to φ10×12.2L
- Suitable for DC-DC converters, voltage regulators and decoupling applications used on computer motherboards etc.
- RoHS Compliant
- Halogen Free



◆ SPECIFICATIONS

Items	Characteristics										
Category											
Temperature Range	-55 to +105°C										
Rated Voltage Range	2.5 to 25V _{dc}										
Capacitance Tolerance	±20% (M) (at 20°C, 120Hz)										
Surge Voltage	Rated voltage × 1.15 (Rated voltage 2.5 to 20V _{dc} , 25V _{dc}) / Rated voltage × 1.00 (Rated voltage 23V _{dc}) (at 105°C)										
Leakage Current	Shall not exceed values shown in STANDARD RATINGS. (at 20°C after 2 minutes)										
Dissipation Factor (tanδ)	0.12 max. (at 20°C, 120Hz)										
Low Temperature Characteristics (Max. Impedance Ratio)	Z(-25°C)/Z(+20°C) ≤ 1.15 Z(-55°C)/Z(+20°C) ≤ 1.25 (at 100kHz)										
Endurance	The following specifications shall be satisfied when the capacitors are restored to 20°C after the rated voltage is applied for 2,000 hours (F45 : 1,000 hours) at 105°C. <table border="1"> <tr><td>Appearance</td><td>No significant damage</td></tr> <tr><td>Capacitance change</td><td>≤ ±20% of the initial value</td></tr> <tr><td>DF (tanδ)</td><td>≤ 150% of the initial specified value</td></tr> <tr><td>ESR</td><td>≤ 150% of the initial specified value</td></tr> <tr><td>Leakage current</td><td>≤ The initial specified value</td></tr> </table>	Appearance	No significant damage	Capacitance change	≤ ±20% of the initial value	DF (tanδ)	≤ 150% of the initial specified value	ESR	≤ 150% of the initial specified value	Leakage current	≤ The initial specified value
Appearance	No significant damage										
Capacitance change	≤ ±20% of the initial value										
DF (tanδ)	≤ 150% of the initial specified value										
ESR	≤ 150% of the initial specified value										
Leakage current	≤ The initial specified value										
Bias Humidity	The following specifications shall be satisfied when the capacitors are restored to 20°C after subjecting them to the DC rated voltage at 60°C, 90 to 95% RH for 1,000 hours (F45 : 500 hours). <table border="1"> <tr><td>Appearance</td><td>No significant damage</td></tr> <tr><td>Capacitance change</td><td>≤ ±20% of the initial value</td></tr> <tr><td>DF (tanδ)</td><td>≤ 150% of the initial specified value</td></tr> <tr><td>ESR</td><td>≤ 150% of the initial specified value</td></tr> <tr><td>Leakage current</td><td>≤ The initial specified value</td></tr> </table>	Appearance	No significant damage	Capacitance change	≤ ±20% of the initial value	DF (tanδ)	≤ 150% of the initial specified value	ESR	≤ 150% of the initial specified value	Leakage current	≤ The initial specified value
Appearance	No significant damage										
Capacitance change	≤ ±20% of the initial value										
DF (tanδ)	≤ 150% of the initial specified value										
ESR	≤ 150% of the initial specified value										
Leakage current	≤ The initial specified value										
Surge Voltage	The capacitors shall be subjected to 1,000 cycles each consisting of charge with the surge voltage specified at 105°C for 30 seconds through a protective resistor (R=1kΩ) and discharge for 5 minutes 30 seconds. <table border="1"> <tr><td>Appearance</td><td>No significant damage</td></tr> <tr><td>Capacitance change</td><td>≤ ±20% of the initial value</td></tr> <tr><td>DF (tanδ)</td><td>≤ 150% of the initial specified value</td></tr> <tr><td>ESR</td><td>≤ 150% of the initial specified value</td></tr> <tr><td>Leakage current</td><td>≤ The initial specified value</td></tr> </table>	Appearance	No significant damage	Capacitance change	≤ ±20% of the initial value	DF (tanδ)	≤ 150% of the initial specified value	ESR	≤ 150% of the initial specified value	Leakage current	≤ The initial specified value
Appearance	No significant damage										
Capacitance change	≤ ±20% of the initial value										
DF (tanδ)	≤ 150% of the initial specified value										
ESR	≤ 150% of the initial specified value										
Leakage current	≤ The initial specified value										
Failure Rate	0.5% per 1,000 hours maximum (Confidence level 60% at 105°C)										

*Note : If any doubt arises, measure the leakage current after the following voltage treatment.
Voltage treatment : DC rated voltage is applied to the capacitors for 120 minutes at 105°C.

◆ DIMENSIONS [mm]

● Terminal Code : A

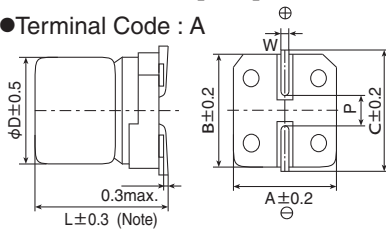

Note : L+0.1/-0.2 for F45
L±0.5 for HC0 and JC0

Size code	φD	L	A	B	C	W	P
D55	4	5.2	4.3	4.3	5.1	0.5 to 0.8	1.0
E60	5	5.7	5.3	5.3	5.9	0.5 to 0.8	1.4
F45	6.3	4.4	6.6	6.6	7.2	0.5 to 0.8	1.9
F55	6.3	5.2	6.6	6.6	7.2	0.5 to 0.8	1.9
F60	6.3	5.7	6.6	6.6	7.2	0.5 to 0.8	1.9
H70	8	6.7	8.3	8.3	9.0	0.7 to 1.1	3.1
HC0	8	12.0	8.3	8.3	9.0	0.7 to 1.1	3.1
J80	10	7.7	10.3	10.3	11.0	0.7 to 1.1	4.5
JC0	10	12.2	10.3	10.3	11.0	0.7 to 1.1	4.5

◆ MARKING

EX) 16V39μF



◆ PART NUMBERING SYSTEM

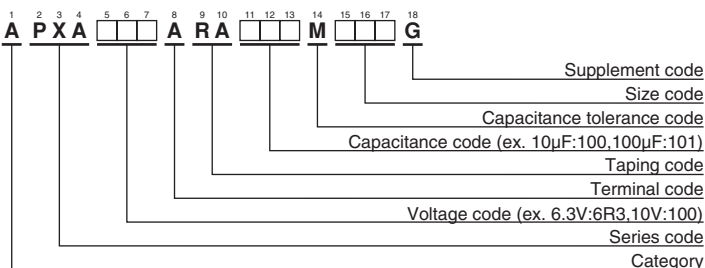

Please refer to "Product code guide (conductive polymer type)"

◆ STANDARD RATINGS

WV (Vdc)	Cap (μF)	Size code	Leakage current (μAmax/ after 2 min.)	ESR (mΩmax/ 20°C, 100k to 300kHz)	Rated ripple current (mA _{rms} /105°C, 100kHz)	Part No.	WV (Vdc)	Cap (μF)	Size code	Leakage current (μAmax/ after 2 min.)	ESR (mΩmax/ 20°C, 100k to 300kHz)	Rated ripple current (mA _{rms} /105°C, 100kHz)	Part No.
2.5	220	F55	110	25	2,500	APXA2R5ARA221MF55G	10	4.7	D55	24.0	240	670	APXA100ARA4R7MD55G
	220	F60	110	25	2,500	APXA2R5ARA221MF60G		6.8	D55	34.0	240	670	APXA100ARA6R8MD55G
	560	H70	280	23	3,100	APXA2R5ARA561MH70G		10	D55	50.0	220	700	APXA100ARA100MD55G
	680	HCO	340	12	4,770	APXA2R5ARA681MHC0G		15	D55	75.0	200	740	APXA100ARA150MD55G
	1,000	J80	500	19	4,240	APXA2R5ARA102MJ80G		33	E60	66.0	40	1,270	APXA100ARA330ME60G
	1,500	JCO	750	10	5,500	APXA2R5ARA152MJCOG		47	E60	94.0	40	1,270	APXA100ARA470ME60G
4	33	D55	66.0	200	740	APXA4R0ARA330MD55G		47	F45	235	41	1,560	APXA100ARA470MF45G
	100	F55	80.0	26	2,450	APXA4R0ARA101MF55G		47	F60	94.0	31	2,250	APXA100ARA470MF60G
	100	F60	80.0	26	2,450	APXA4R0ARA101MF60G		56	F55	112	31	2,250	APXA100ARA560MF55G
	120	F45	240	38	1,710	APXA4R0ARA121MF45G		56	F60	112	31	2,250	APXA100ARA560MF60G
	150	E60	120	30	1,490	APXA4R0ARA151ME60G		120	H70	240	27	2,800	APXA100ARA121MH70G
	150	F55	120	26	2,450	APXA4R0ARA151MF55G		150	H70	300	27	2,800	APXA100ARA151MH70G
	150	F60	120	26	2,450	APXA4R0ARA151MF60G		270	HCO	540	14	4,420	APXA100ARA271MHC0G
	220	H70	176	25	3,020	APXA4R0ARA221MH70G		270	J80	540	24	3,770	APXA100ARA271MJ80G
	330	H70	264	25	3,020	APXA4R0ARA331MH70G		330	HCO	660	14	4,420	APXA100ARA331MHC0G
	470	J80	376	20	4,130	APXA4R0ARA471MJ80G		330	J80	660	24	3,770	APXA100ARA331MJ80G
	560	HCO	448	12	4,770	APXA4R0ARA561MHC0G		470	JCO	940	12	5,300	APXA100ARA471MJCOG
	680	J80	544	20	4,130	APXA4R0ARA681MJ80G		560	JCO	1,120	12	5,300	APXA100ARA561MJCOG
820	JCO	656	10	5,500	APXA4R0ARA821MJCOG	16	3.3	D55	26.0	260	660	APXA160ARA3R3MD55G	
1,200	JCO	960	10	5,500	APXA4R0ARA122MJCOG		22	E60	70.4	45	1,210	APXA160ARA220MH60G	
6.3	22	D55	69.0	200	740		APXA6R3ARA220MD55G	22	F45	176	45	1,490	APXA160ARA220MF45G
	47	E60	59.2	35	1,380		APXA6R3ARA470ME60G	33	F60	106	37	2,050	APXA160ARA330MF60G
	68	F60	85.6	27	2,400		APXA6R3ARA680MF60G	39	F55	125	37	2,050	APXA160ARA390MF55G
	82	F45	267	40	1,670		APXA6R3ARA820MF45G	39	F60	125	37	2,050	APXA160ARA390MF60G
	82	F55	103	27	2,400		APXA6R3ARA820MF55G	82	H70	262	30	2,700	APXA160ARA820MH70G
	82	F60	103	27	2,400		APXA6R3ARA820MF60G	150	J80	480	26	3,430	APXA160ARA151MJ80G
	100	E60	126	35	1,380		APXA6R3ARA101ME60G	180	HCO	576	16	4,360	APXA160ARA181MHC0G
	100	F45	315	40	1,670		APXA6R3ARA101MF45G	180	J80	576	26	3,430	APXA160ARA181MJ80G
	100	F55	126	27	2,400		APXA6R3ARA101MF55G	220	JCO	704	14	5,050	APXA160ARA221MJCOG
	100	F60	126	27	2,400		APXA6R3ARA101MF60G	330	JCO	1,050	14	5,050	APXA160ARA331MJCOG
	120	F60	151	27	2,400	APXA6R3ARA121MF60G	20	15	F45	150	57	1,300	APXA200ARA150MF45G
	150	H70	189	25	3,020	APXA6R3ARA151MH70G		22	F55	88.0	50	1,650	APXA200ARA220MF55G
	220	H70	277	25	3,020	APXA6R3ARA221MH70G		22	F60	88.0	50	1,650	APXA200ARA220MF60G
	330	J80	416	20	4,130	APXA6R3ARA331MJ80G		39	H70	156	45	2,000	APXA200ARA390MH70G
	390	HCO	491	12	4,770	APXA6R3ARA391MHC0G		47	H70	188	45	2,000	APXA200ARA470MH70G
	470	HCO	592	12	4,770	APXA6R3ARA471MHC0G		82	J80	328	40	2,500	APXA200ARA820MJ80G
	470	J80	592	20	4,130	APXA6R3ARA471MJ80G		150	JCO	600	20	4,320	APXA200ARA151MJCOG
	680	JCO	857	10	5,500	APXA6R3ARA681MJCOG		23	15	F45	172	57	1,300
820	JCO	1,030	10	5,500	APXA6R3ARA821MJCOG	10			F60	125	65	1,500	APXA250ARA100MF60G
25	22	H70	275	50	1,800	APXA250ARA220MH70G			22	H70	275	50	1,800
	39	J80	488	45	2,100	APXA250ARA390MJ80G		39	J80	488	45	2,100	APXA250ARA390MJ80G

New!

NPCAP™-PXD Series

- Super low ESR, impedance and high heat resistance have been obtained by using conductive polymer as electrolyte.
- For automobile modules and other high temperature applications
- Endurance : 125°C 2,000 hours
- Rated voltage range : 2.5 to 10V_{dc}, Capacitance range : 47 to 470μF
- RoHS Compliant
- Halogen Free

PXD

↑ Longer life
PXH



◆ SPECIFICATIONS

Items	Characteristics										
Category Temperature Range	-55 to +125°C										
Rated Voltage Range	2.5 to 10V _{dc}										
Capacitance Tolerance	±20% (M) (at 20°C, 120Hz)										
Surge Voltage	Rated voltage×1.15 (at 125°C)										
Leakage Current	Shall not exceed values shown in STANDARD RATINGS. (at 20°C after 2 minutes)										
Dissipation Factor (tanδ)	0.12 max. (at 20°C, 120Hz)										
Low Temperature Characteristics (Max. Impedance Ratio)	Z(-25°C)/Z(+20°C) ≤ 1.15 Z(-55°C)/Z(+20°C) ≤ 1.25 (at 100kHz)										
Endurance	The following specifications shall be satisfied when the capacitors are restored to 20°C after the rated voltage is applied for 2,000 hours at 125°C.										
	<table border="1"> <tr> <td>Appearance</td> <td>No significant damage</td> </tr> <tr> <td>Capacitance change</td> <td>≤ ±20% of the initial value</td> </tr> <tr> <td>DF (tanδ)</td> <td>≤ 200% of the initial specified value</td> </tr> <tr> <td>ESR</td> <td>≤ 200% of the initial specified value</td> </tr> <tr> <td>Leakage current</td> <td>≤ The initial specified value</td> </tr> </table>	Appearance	No significant damage	Capacitance change	≤ ±20% of the initial value	DF (tanδ)	≤ 200% of the initial specified value	ESR	≤ 200% of the initial specified value	Leakage current	≤ The initial specified value
Appearance	No significant damage										
Capacitance change	≤ ±20% of the initial value										
DF (tanδ)	≤ 200% of the initial specified value										
ESR	≤ 200% of the initial specified value										
Leakage current	≤ The initial specified value										
Bias Humidity	The following specifications shall be satisfied when the capacitors are restored to 20°C after subjecting them to the DC rated voltage at 60°C, 90 to 95% RH for 1,000 hours.										
	<table border="1"> <tr> <td>Appearance</td> <td>No significant damage</td> </tr> <tr> <td>Capacitance change</td> <td>≤ ±20% of the initial value</td> </tr> <tr> <td>DF (tanδ)</td> <td>≤ 150% of the initial specified value</td> </tr> <tr> <td>ESR</td> <td>≤ 150% of the initial specified value</td> </tr> <tr> <td>Leakage current</td> <td>≤ The initial specified value</td> </tr> </table>	Appearance	No significant damage	Capacitance change	≤ ±20% of the initial value	DF (tanδ)	≤ 150% of the initial specified value	ESR	≤ 150% of the initial specified value	Leakage current	≤ The initial specified value
Appearance	No significant damage										
Capacitance change	≤ ±20% of the initial value										
DF (tanδ)	≤ 150% of the initial specified value										
ESR	≤ 150% of the initial specified value										
Leakage current	≤ The initial specified value										
Surge Voltage	The capacitors shall be subjected to 1,000 cycles each consisting of charge with the surge voltage specified at 125°C for 30 seconds through a protective resistor(R=1kΩ) and discharge for 5 minutes 30 seconds.										
	<table border="1"> <tr> <td>Appearance</td> <td>No significant damage</td> </tr> <tr> <td>Capacitance change</td> <td>≤ ±20% of the initial value</td> </tr> <tr> <td>DF (tanδ)</td> <td>≤ 150% of the initial specified value</td> </tr> <tr> <td>ESR</td> <td>≤ 150% of the initial specified value</td> </tr> <tr> <td>Leakage current</td> <td>≤ The initial specified value</td> </tr> </table>	Appearance	No significant damage	Capacitance change	≤ ±20% of the initial value	DF (tanδ)	≤ 150% of the initial specified value	ESR	≤ 150% of the initial specified value	Leakage current	≤ The initial specified value
Appearance	No significant damage										
Capacitance change	≤ ±20% of the initial value										
DF (tanδ)	≤ 150% of the initial specified value										
ESR	≤ 150% of the initial specified value										
Leakage current	≤ The initial specified value										
Failure Rate	0.5% per 1,000 hours maximum (Confidence level 60% at 125°C)										

*Note : If any doubt arises, measure the leakage current after the following voltage treatment.
Voltage treatment : DC rated voltage is applied to the capacitors for 120 minutes at 125°C.

◆ DIMENSIONS [mm]

● Terminal Code : A

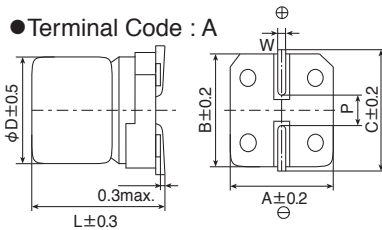

Size code	φD	L	A	B	C	W	P
E61	5	5.8	5.3	5.3	5.9	0.5 to 0.8	1.4
F61	6.3	5.8	6.6	6.6	7.2	0.5 to 0.8	1.9
H70	8	6.7	8.3	8.3	9.0	0.7 to 1.1	3.1
J80	10	7.7	10.3	10.3	11.0	0.7 to 1.1	4.5

◆ MARKING

EX) 10V330μF



◆ PART NUMBERING SYSTEM

1 2 3 4 5 6 7 8 9 10 11 12 13 14 15 16 17 18
A P X D [] [] A R A [] [] M [] [] G

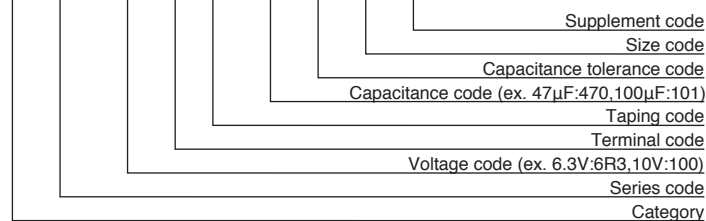

Please refer to "Product code guide (conductive polymer type)"



New!

NPCAP™-PXD Series

◆STANDARD RATINGS

WV(Vdc)	Cap(μF)	Size code	Leakage current (μAmax/after 2min.)	ESR (mΩ max/20°C, 100k to 300kHz)	Rated ripple current (mArms/100kHz)		Part No.
					-55°C ≤ Tx ≤ +105°C*1	+105°C < Tx ≤ +125°C*1	
2.5	120	E61	60.0	40	1,450	650	APXD2R5ARA121ME61G
	220	F61	110	30	2,500	770	APXD2R5ARA221MF61G
6.3	56	E61	70.5	45	1,380	600	APXD6R3ARA560ME61G
	100	F61	126	35	2,400	720	APXD6R3ARA101MF61G
	220	H70	277	30	3,020	960	APXD6R3ARA221MH70G
	470	J80	592	25	3,500	1,100	APXD6R3ARA471MJ80G
10	47	E61	94.0	50	1,270	550	APXD100ARA470ME61G
	56	F61	112	40	2,250	680	APXD100ARA560MF61G
	150	H70	300	35	2,800	880	APXD100ARA151MH70G
	330	J80	660	25	3,500	1,100	APXD100ARA331MJ80G

*1 Tx : Ambient temperature (°C)

NPCAP™-PXH Series

- Super low ESR, impedance and high heat resistance have been obtained by using conductive polymer as electrolyte.
- Suitable for DC-DC converters, voltage regulators and decoupling applications.
- Endurance : 125°C 1,000 hours
- Rated voltage range : 2.5 to 20V_{dc}, Capacitance range : 22 to 1,000μF
- Case size range : φ6.3×5.7L to φ10×7.7L
- RoHS Compliant
- Halogen Free

PXH

Higher temperature

PXA



◆ SPECIFICATIONS

Items	Characteristics										
Category Temperature Range	-55 to +125°C										
Rated Voltage Range	2.5 to 20V _{dc}										
Capacitance Tolerance	±20% (M) (at 20°C, 120Hz)										
Surge Voltage	Rated voltage×1.15 (at 125°C)										
Leakage Current	Shall not exceed values shown in STANDARD RATINGS. (at 20°C after 2 minutes)										
Dissipation Factor (tanδ)	0.12 max. (at 20°C, 120Hz)										
Low Temperature Characteristics (Max. Impedance Ratio)	Z(-25°C)/Z(+20°C) ≤ 1.15 Z(-55°C)/Z(+20°C) ≤ 1.25 (at 100kHz)										
Endurance	The following specifications shall be satisfied when the capacitors are restored to 20°C after the rated voltage is applied for 1,000 hours at 125°C. <table border="1"> <tr> <td>Appearance</td> <td>No significant damage</td> </tr> <tr> <td>Capacitance change</td> <td>≤ ±20% of the initial value</td> </tr> <tr> <td>DF (tanδ)</td> <td>≤ 200% of the initial specified value</td> </tr> <tr> <td>ESR</td> <td>≤ 200% of the initial specified value</td> </tr> <tr> <td>Leakage current</td> <td>≤ The initial specified value</td> </tr> </table>	Appearance	No significant damage	Capacitance change	≤ ±20% of the initial value	DF (tanδ)	≤ 200% of the initial specified value	ESR	≤ 200% of the initial specified value	Leakage current	≤ The initial specified value
Appearance	No significant damage										
Capacitance change	≤ ±20% of the initial value										
DF (tanδ)	≤ 200% of the initial specified value										
ESR	≤ 200% of the initial specified value										
Leakage current	≤ The initial specified value										
Bias Humidity	The following specifications shall be satisfied when the capacitors are restored to 20°C after subjecting them to the DC rated voltage at 60°C, 90 to 95% RH for 1,000 hours. <table border="1"> <tr> <td>Appearance</td> <td>No significant damage</td> </tr> <tr> <td>Capacitance change</td> <td>≤ ±20% of the initial value</td> </tr> <tr> <td>DF (tanδ)</td> <td>≤ 150% of the initial specified value</td> </tr> <tr> <td>ESR</td> <td>≤ 150% of the initial specified value</td> </tr> <tr> <td>Leakage current</td> <td>≤ The initial specified value</td> </tr> </table>	Appearance	No significant damage	Capacitance change	≤ ±20% of the initial value	DF (tanδ)	≤ 150% of the initial specified value	ESR	≤ 150% of the initial specified value	Leakage current	≤ The initial specified value
Appearance	No significant damage										
Capacitance change	≤ ±20% of the initial value										
DF (tanδ)	≤ 150% of the initial specified value										
ESR	≤ 150% of the initial specified value										
Leakage current	≤ The initial specified value										
Surge Voltage	The capacitors shall be subjected to 1,000 cycles each consisting of charge with the surge voltage specified at 125°C for 30 seconds through a protective resistor(R=1kΩ) and discharge for 5 minutes 30 seconds. <table border="1"> <tr> <td>Appearance</td> <td>No significant damage</td> </tr> <tr> <td>Capacitance change</td> <td>≤ ±20% of the initial value</td> </tr> <tr> <td>DF (tanδ)</td> <td>≤ 150% of the initial specified value</td> </tr> <tr> <td>ESR</td> <td>≤ 150% of the initial specified value</td> </tr> <tr> <td>Leakage current</td> <td>≤ The initial specified value</td> </tr> </table>	Appearance	No significant damage	Capacitance change	≤ ±20% of the initial value	DF (tanδ)	≤ 150% of the initial specified value	ESR	≤ 150% of the initial specified value	Leakage current	≤ The initial specified value
Appearance	No significant damage										
Capacitance change	≤ ±20% of the initial value										
DF (tanδ)	≤ 150% of the initial specified value										
ESR	≤ 150% of the initial specified value										
Leakage current	≤ The initial specified value										
Failure Rate	0.5% per 1,000 hours maximum (Confidence level 60% at 125°C)										

*Note : If any doubt arises, measure the leakage current after the following voltage treatment.
Voltage treatment : DC rated voltage is applied to the capacitors for 120 minutes at 125°C.

◆ DIMENSIONS [mm]

● Terminal Code : A

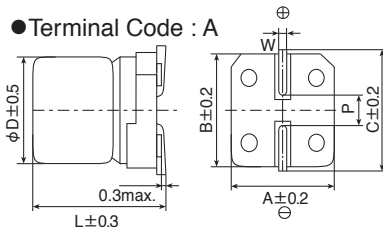

Size code	φD	L	A	B	C	W	P
F60	6.3	5.7	6.6	6.6	7.2	0.5 to 0.8	1.9
H70	8	6.7	8.3	8.3	9.0	0.7 to 1.1	3.1
J80	10	7.7	10.3	10.3	11.0	0.7 to 1.1	4.5

◆ MARKING

EX) 20V22μF



◆ PART NUMBERING SYSTEM

1 2 3 4 5 6 7 8 9 10 11 12 13 14 15 16 17 18
A PXH [] [] A RA [] [] M [] [] G

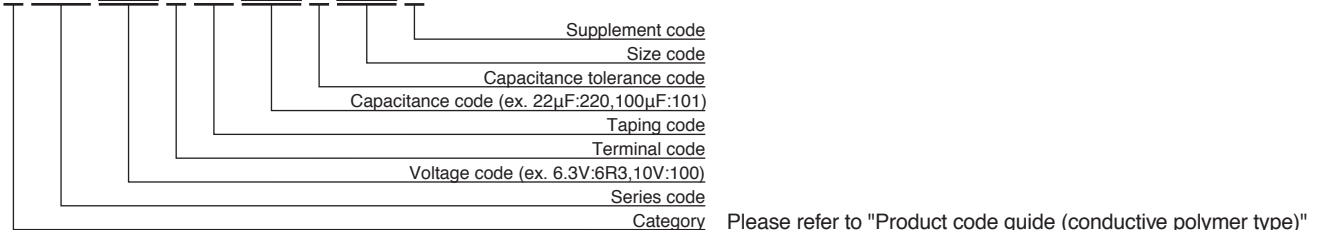

Please refer to "Product code guide (conductive polymer type)"



◆STANDARD RATINGS

WV(Vdc)	Cap(μF)	Size code	Leakage current (μAmax/after 2min.)	ESR (mΩ max/20°C, 100k to 300kHz)	Rated ripple current (mArms/100kHz)		Part No.
					-55°C ≤ Tx ≤ +105°C*1	+105°C < Tx ≤ +125°C*1	
2.5	220	F60	110	35	2,500	770	APXH2R5ARA221MF60G
	560	H70	280	30	3,100	960	APXH2R5ARA561MH70G
	1,000	J80	500	25	3,700	1,100	APXH2R5ARA102MJ80G
4	150	F60	120	35	2,450	770	APXH4R0ARA151MF60G
	220	H70	176	30	3,020	960	APXH4R0ARA221MH70G
	680	J80	544	25	3,700	1,100	APXH4R0ARA681MJ80G
6.3	82	F60	103	40	2,400	720	APXH6R3ARA820MF60G
	100	F60	126	40	2,400	720	APXH6R3ARA101MF60G
	150	H70	189	30	3,020	960	APXH6R3ARA151MH70G
	220	H70	277	30	3,020	960	APXH6R3ARA221MH70G
	470	J80	592	25	3,700	1,100	APXH6R3ARA471MJ80G
10	56	F60	112	45	2,250	680	APXH100ARA560MF60G
	120	H70	240	35	2,800	880	APXH100ARA121MH70G
	150	H70	300	35	2,800	880	APXH100ARA151MH70G
	330	J80	660	30	3,700	1,010	APXH100ARA331MJ80G
16	39	F60	125	50	2,050	650	APXH160ARA390MF60G
	82	H70	262	40	2,700	830	APXH160ARA820MH70G
	150	J80	480	35	3,020	930	APXH160ARA151MJ80G
	180	J80	576	35	3,020	930	APXH160ARA181MJ80G
20	22	F60	88.0	60	1,650	590	APXH200ARA220MF60G
	47	H70	188	45	2,000	780	APXH200ARA470MH70G
	82	J80	328	45	2,400	820	APXH200ARA820MJ80G

*1 Tx : Ambient temperature (°C)

Upgrade!

NPCAP™-PSG Series

- Super low ESR, high ripple current capability
- Endurance: 2,000 to 5,000 hours at 105°C
- Rated voltage : 16 to 25V_{dc}
- RoHS Compliant
- Halogen Free

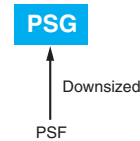

◆ SPECIFICATIONS

Items	Characteristics										
Category											
Temperature Range	-55 to +105°C										
Rated Voltage	16 to 25V _{dc}										
Capacitance Tolerance	±20% (M) (at 20°C, 120Hz)										
Surge Voltage	Rated voltage(V)×1.15 (at 105°C)										
Leakage Current	I=0.2CV or 500μA, whichever is greater										
*Note	Where, I : Leakage current (μA), C : Nominal capacitance (μF), V : Rated voltage (V) (at 20°C after 2 minutes)										
Dissipation Factor (tanδ)	0.12 max. (at 20°C, 120Hz)										
Low Temperature Characteristics (Max.Impedance Ratio)	Z(-25°C)/Z(+20°C) ≤ 1.15 Z(-55°C)/Z(+20°C) ≤ 1.25 (at 100kHz)										
Endurance	The following specifications shall be satisfied when the capacitors are restored to 20°C after the rated voltage is applied for 5,000 hours (20, 25V : 2,000 hours) at 105°C.										
	<table border="1"> <tr> <td>Appearance</td> <td>No significant damage</td> </tr> <tr> <td>Capacitance change</td> <td>≤ ±20% of the initial value</td> </tr> <tr> <td>D.F. (tanδ)</td> <td>≤ The initial specified value</td> </tr> <tr> <td>ESR</td> <td>≤ 150% of the initial specified value</td> </tr> <tr> <td>Leakage current</td> <td>≤ The initial specified value</td> </tr> </table>	Appearance	No significant damage	Capacitance change	≤ ±20% of the initial value	D.F. (tanδ)	≤ The initial specified value	ESR	≤ 150% of the initial specified value	Leakage current	≤ The initial specified value
Appearance	No significant damage										
Capacitance change	≤ ±20% of the initial value										
D.F. (tanδ)	≤ The initial specified value										
ESR	≤ 150% of the initial specified value										
Leakage current	≤ The initial specified value										
Bias Humidity Test	The following specifications shall be satisfied when the capacitors are restored to 20°C after subjecting them to DC voltage at 60°C, 90 to 95% RH for 1,000 hours.										
	<table border="1"> <tr> <td>Appearance</td> <td>No significant damage</td> </tr> <tr> <td>Capacitance change</td> <td>≤ ±20% of the initial value</td> </tr> <tr> <td>D.F. (tanδ)</td> <td>≤ The initial specified value</td> </tr> <tr> <td>ESR</td> <td>≤ 150% of the initial specified value</td> </tr> <tr> <td>Leakage current</td> <td>≤ The initial specified value</td> </tr> </table>	Appearance	No significant damage	Capacitance change	≤ ±20% of the initial value	D.F. (tanδ)	≤ The initial specified value	ESR	≤ 150% of the initial specified value	Leakage current	≤ The initial specified value
Appearance	No significant damage										
Capacitance change	≤ ±20% of the initial value										
D.F. (tanδ)	≤ The initial specified value										
ESR	≤ 150% of the initial specified value										
Leakage current	≤ The initial specified value										
Surge Voltage Test	The capacitors shall be subjected to 1,000 cycles each consisting of charge with the surge voltage specified at 105°C for 30 seconds through a protective resistor(R=1kΩ) and discharge for 5 minutes 30 seconds.										
	<table border="1"> <tr> <td>Appearance</td> <td>No significant damage</td> </tr> <tr> <td>Capacitance change</td> <td>≤ ±20% of the initial value</td> </tr> <tr> <td>D.F. (tanδ)</td> <td>≤ The initial specified value</td> </tr> <tr> <td>ESR</td> <td>≤ 150% of the initial specified value</td> </tr> <tr> <td>Leakage current</td> <td>≤ The initial specified value</td> </tr> </table>	Appearance	No significant damage	Capacitance change	≤ ±20% of the initial value	D.F. (tanδ)	≤ The initial specified value	ESR	≤ 150% of the initial specified value	Leakage current	≤ The initial specified value
Appearance	No significant damage										
Capacitance change	≤ ±20% of the initial value										
D.F. (tanδ)	≤ The initial specified value										
ESR	≤ 150% of the initial specified value										
Leakage current	≤ The initial specified value										
Failure Rate	0.5% per 1,000 hours maximum (Confidence level 60% at 105°C)										

*Note : If any doubt arises, measure the leakage current after the following voltage treatment.
Voltage treatment : DC rated voltage is applied to the capacitors for 120 minutes at 105°C.

◆ DIMENSIONS [mm]

- Terminal Code : E

F05,F08,H06,H08

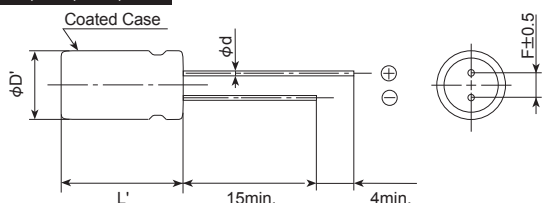

HB5,JB5

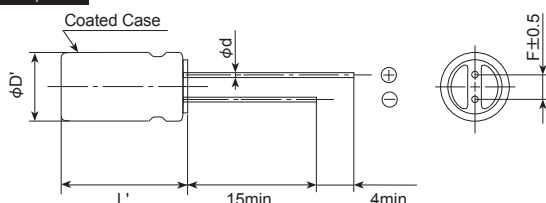

Size code	F05	F08	H06	H08	HB5	JB5
φD	6.3		8.0			10.0
φd	0.45		0.6			
F	2.5		3.5		5.0	
φD'	φD+0.5max.					
L'	L+1.0max.			L+1.5max.		

◆ MARKING

EX) 16V150μF

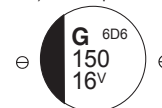

◆PART NUMBERING SYSTEM

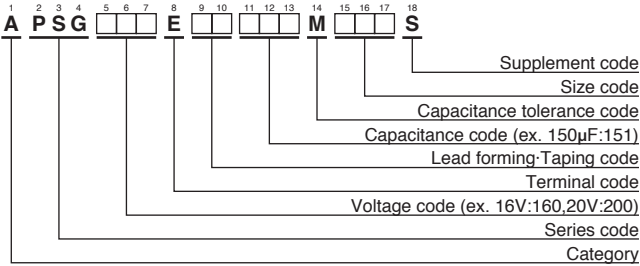

Please refer to "Product code guide (conductive polymer type)"

◆STANDARD RATINGS

WV (V _{dc})	Cap (µF)	Case size φD×L (mm)	ESR (mΩ max./20°C, 100k to 300kHz)	Rated ripple current (mA _{rms} /105°C, 100kHz)	Part No.
16	150	6.3×5	20	3,200	APSG160E□□151MF05S
	270	6.3×8	15	3,800	APSG160E□□271MF08S
	270	8×6	22	3,300	APSG160E□□271MH06S
	470	8×8	16	4,000	APSG160E□□471MH08S
	560	8×11.5	14	4,970	APSG160E□□561MHB5S
	820	10×11.5	12	5,400	APSG160E□□821MJB5S
1,000	10×11.5	12	5,400	APSG160E□□102MJB5S	
20	120	6.3×5	20	3,200	APSG200E□□121MF05S
	180	6.3×8	18	3,460	APSG200E□□181MF08S
	330	8×8	17	3,880	APSG200E□□331MH08S
	390	8×11.5	14	4,970	APSG200E□□391MHB5S
	680	10×11.5	12	5,400	APSG200E□□681MJB5S
25	56	6.3×5	30	2,600	APSG250E□□560MF05S
	82	6.3×8	28	2,780	APSG250E□□820MF08S
	180	8×8	18	3,770	APSG250E□□181MH08S
	180	8×11.5	16	4,650	APSG250E□□181MHB5S
	220	8×11.5	16	4,650	APSG250E□□221MHB5S
	330	10×11.5	14	5,000	APSG250E□□331MJB5S
	390	10×11.5	14	5,000	APSG250E□□391MJB5S

□□ : Enter the appropriate lead forming or taping code.

Upgrade!

NPCAP™-PSK Series

- Super low ESR, high ripple current capability
- Downsized from PSE series (φ6.3×8L to φ5×8L)
- Longer life (5,000 hours at 105°C)
- ESR after endurance is specified within the initial spec
- RoHS Compliant
- Halogen Free



◆ SPECIFICATIONS

Items	Characteristics										
Category											
Temperature Range	-55 to +105°C										
Rated Voltage Range	2.5 to 6.3 V _{dc}										
Capacitance Tolerance	±20% (M) (at 20°C, 120Hz)										
Surge Voltage	Rated voltage(V) × 1.15 (at 105°C)										
Leakage Current* ^{Note}	500μA max. (at 20°C after 2 minutes)										
Dissipation Factor (tanδ)	0.10 max. (at 20°C, 120Hz)										
Low Temperature Characteristics (Max.Impedance Ratio)	Z(-25°C)/Z(+20°C) ≤ 1.15 Z(-55°C)/Z(+20°C) ≤ 1.25 (at 100kHz)										
Endurance	The following specifications shall be satisfied when the capacitors are restored to 20°C after the rated voltage is applied for 5,000 hours at 105°C.										
	<table border="1"> <tr> <td>Appearance</td> <td>No significant damage</td> </tr> <tr> <td>Capacitance change</td> <td>≤ ±20% of the initial value</td> </tr> <tr> <td>D.F. (tanδ)</td> <td>≤ The initial specified value</td> </tr> <tr> <td>ESR</td> <td>≤ The initial specified value</td> </tr> <tr> <td>Leakage current</td> <td>≤ The initial specified value</td> </tr> </table>	Appearance	No significant damage	Capacitance change	≤ ±20% of the initial value	D.F. (tanδ)	≤ The initial specified value	ESR	≤ The initial specified value	Leakage current	≤ The initial specified value
Appearance	No significant damage										
Capacitance change	≤ ±20% of the initial value										
D.F. (tanδ)	≤ The initial specified value										
ESR	≤ The initial specified value										
Leakage current	≤ The initial specified value										
Bias Humidity Test	The following specifications shall be satisfied when the capacitors are restored to 20°C after subjecting them to DC voltage at 60°C, 90 to 95% RH for 1,000 hours.										
	<table border="1"> <tr> <td>Appearance</td> <td>No significant damage</td> </tr> <tr> <td>Capacitance change</td> <td>≤ ±20% of the initial value</td> </tr> <tr> <td>D.F. (tanδ)</td> <td>≤ The initial specified value</td> </tr> <tr> <td>ESR</td> <td>≤ The initial specified value</td> </tr> <tr> <td>Leakage current</td> <td>≤ The initial specified value</td> </tr> </table>	Appearance	No significant damage	Capacitance change	≤ ±20% of the initial value	D.F. (tanδ)	≤ The initial specified value	ESR	≤ The initial specified value	Leakage current	≤ The initial specified value
Appearance	No significant damage										
Capacitance change	≤ ±20% of the initial value										
D.F. (tanδ)	≤ The initial specified value										
ESR	≤ The initial specified value										
Leakage current	≤ The initial specified value										
Surge Voltage Test	The capacitors shall be subjected to 1,000 cycles each consisting of charge with the surge voltage specified at 105°C for 30 seconds through a protective resistor (R=1kΩ) and discharge for 5 minutes 30 seconds.										
	<table border="1"> <tr> <td>Appearance</td> <td>No significant damage</td> </tr> <tr> <td>Capacitance change</td> <td>≤ ±20% of the initial value</td> </tr> <tr> <td>D.F. (tanδ)</td> <td>≤ The initial specified value</td> </tr> <tr> <td>ESR</td> <td>≤ The initial specified value</td> </tr> <tr> <td>Leakage current</td> <td>≤ The initial specified value</td> </tr> </table>	Appearance	No significant damage	Capacitance change	≤ ±20% of the initial value	D.F. (tanδ)	≤ The initial specified value	ESR	≤ The initial specified value	Leakage current	≤ The initial specified value
Appearance	No significant damage										
Capacitance change	≤ ±20% of the initial value										
D.F. (tanδ)	≤ The initial specified value										
ESR	≤ The initial specified value										
Leakage current	≤ The initial specified value										
Failure Rate	0.5% per 1,000 hours maximum (Confidence level 60% at 105°C)										

*Note : If any doubt arises, measure the leakage current after the following voltage treatment.
Voltage treatment : DC rated voltage is applied to the capacitors for 120 minutes at 105°C.

◆ DIMENSIONS [mm]

- Terminal Code : E

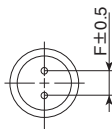
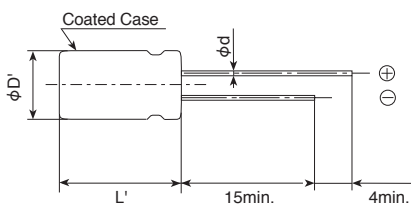

Size code	E08
φD	5.0
φd	0.5(Note2)
F	2.0
φD'	φD+0.5max.
L'	L+1.0max.

Note2 : 0.45 for rated voltage 2.5V

◆ MARKING

EX) 2.5V560μF



◆PART NUMBERING SYSTEM

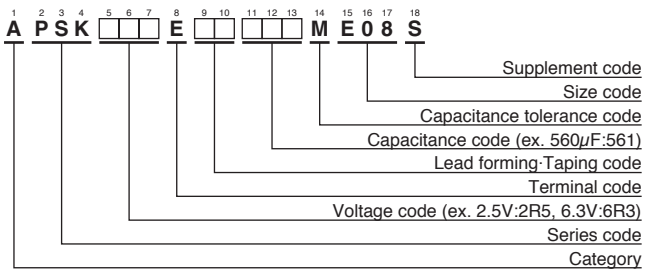

Please refer to "Product code guide (conductive polymer type)"

◆STANDARD RATINGS

WV(Vdc)	Cap(μF)	Case size φD×L (mm)	ESR (mΩ max./20°C, 100k to 300kHz)	Rated ripple current (mArms/105°C, 100kHz)	Part No.
2.5	220	5×8	7	4,350	APSK2R5E□□221ME08S
	330	5×8	7	4,350	APSK2R5E□□331ME08S
	470	5×8	7	4,350	APSK2R5E□□471ME08S
	560	5×8	7	4,350	APSK2R5E□□561ME08S
6.3	270	5×8	10	3,700	APSK6R3E□□271ME08S
	330	5×8	8	4,050	APSK6R3E□□331ME08S

□□ : Enter the appropriate lead forming or taping code.

Upgrade!

NPCAP™-PSF Series

- Super low ESR, high ripple current capability
- ESR 5mΩ max. (2 to 4V_{dc})
- Longer life (5,000 hours at 105°C)
- ESR after endurance is specified within the initial spec (2 to 4V_{dc})
- Rated voltage range : 2 to 16V_{dc}
- RoHS Compliant
- Halogen Free

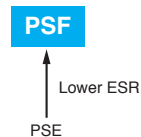

◆ SPECIFICATIONS

Items	Characteristics											
Category												
Temperature Range	-55 to +105°C											
Rated Voltage Range	2 to 16V _{dc}											
Capacitance Tolerance	±20% (M) (at 20°C, 120Hz)											
Surge Voltage	Rated voltage(V) × 1.15 (at 105°C)											
Leakage Current *Note	Shall not exceed values shown in STANDARD RATINGS. (at 20°C after 2 minutes)											
Dissipation Factor (tanδ)	0.10 max. (at 20°C, 120Hz)											
Low Temperature Characteristics (Max.Impedance Ratio)	Z(-25°C)/Z(+20°C) ≤ 1.15 Z(-55°C)/Z(+20°C) ≤ 1.25 (at 100kHz)											
Endurance	The following specifications shall be satisfied when the capacitors are restored to 20°C after the rated voltage is applied for 5,000 hours at 105°C.											
	<table border="1"> <tr> <td>Appearance</td> <td>No significant damage</td> </tr> <tr> <td>Capacitance change</td> <td>≤ ±20% of the initial value</td> </tr> <tr> <td>D.F. (tanδ)</td> <td>≤ The initial specified value</td> </tr> <tr> <td rowspan="2">ESR</td> <td>2 to 4V_{dc} : ≤ The initial specified value</td> </tr> <tr> <td>16V_{dc} : ≤ 150% of the initial specified value</td> </tr> <tr> <td>Leakage current</td> <td>≤ The initial specified value</td> </tr> </table>	Appearance	No significant damage	Capacitance change	≤ ±20% of the initial value	D.F. (tanδ)	≤ The initial specified value	ESR	2 to 4V _{dc} : ≤ The initial specified value	16V _{dc} : ≤ 150% of the initial specified value	Leakage current	≤ The initial specified value
Appearance	No significant damage											
Capacitance change	≤ ±20% of the initial value											
D.F. (tanδ)	≤ The initial specified value											
ESR	2 to 4V _{dc} : ≤ The initial specified value											
	16V _{dc} : ≤ 150% of the initial specified value											
Leakage current	≤ The initial specified value											
Bias Humidity Test	The following specifications shall be satisfied when the capacitors are restored to 20°C after subjecting them to DC voltage at 60°C, 90 to 95% RH for 1,000 hours.											
	<table border="1"> <tr> <td>Appearance</td> <td>No significant damage</td> </tr> <tr> <td>Capacitance change</td> <td>≤ ±20% of the initial value</td> </tr> <tr> <td>D.F. (tanδ)</td> <td>≤ The initial specified value</td> </tr> <tr> <td rowspan="2">ESR</td> <td>2 to 4V_{dc} : ≤ The initial specified value</td> </tr> <tr> <td>16V_{dc} : ≤ 150% of the initial specified value</td> </tr> <tr> <td>Leakage current</td> <td>≤ The initial specified value</td> </tr> </table>	Appearance	No significant damage	Capacitance change	≤ ±20% of the initial value	D.F. (tanδ)	≤ The initial specified value	ESR	2 to 4V _{dc} : ≤ The initial specified value	16V _{dc} : ≤ 150% of the initial specified value	Leakage current	≤ The initial specified value
Appearance	No significant damage											
Capacitance change	≤ ±20% of the initial value											
D.F. (tanδ)	≤ The initial specified value											
ESR	2 to 4V _{dc} : ≤ The initial specified value											
	16V _{dc} : ≤ 150% of the initial specified value											
Leakage current	≤ The initial specified value											
Surge Voltage Test	The capacitors shall be subjected to 1,000 cycles each consisting of charge with the surge voltage specified at 105°C for 30 seconds through a protective resistor (R=1kΩ) and discharge for 5 minutes 30 seconds.											
	<table border="1"> <tr> <td>Appearance</td> <td>No significant damage</td> </tr> <tr> <td>Capacitance change</td> <td>≤ ±20% of the initial value</td> </tr> <tr> <td>D.F. (tanδ)</td> <td>≤ The initial specified value</td> </tr> <tr> <td rowspan="2">ESR</td> <td>2 to 4V_{dc} : ≤ The initial specified value</td> </tr> <tr> <td>16V_{dc} : ≤ 150% of the initial specified value</td> </tr> <tr> <td>Leakage current</td> <td>≤ The initial specified value</td> </tr> </table>	Appearance	No significant damage	Capacitance change	≤ ±20% of the initial value	D.F. (tanδ)	≤ The initial specified value	ESR	2 to 4V _{dc} : ≤ The initial specified value	16V _{dc} : ≤ 150% of the initial specified value	Leakage current	≤ The initial specified value
Appearance	No significant damage											
Capacitance change	≤ ±20% of the initial value											
D.F. (tanδ)	≤ The initial specified value											
ESR	2 to 4V _{dc} : ≤ The initial specified value											
	16V _{dc} : ≤ 150% of the initial specified value											
Leakage current	≤ The initial specified value											
Failure Rate	0.5% per 1,000 hours maximum (Confidence level 60% at 105°C)											

*Note : If any doubt arises, measure the leakage current after the following voltage treatment.
Voltage treatment : DC rated voltage is applied to the capacitors for 120 minutes at 105°C.

◆ DIMENSIONS [mm]

● Terminal Code : E

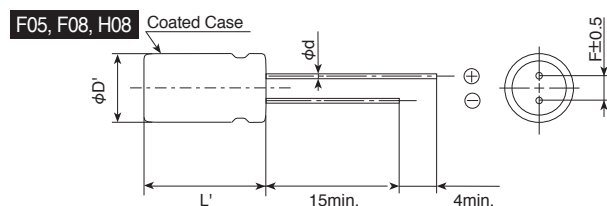

Size code	F05	F08	FA5	H08	HB5	JB5
φD	6.3			8.0		
φd	0.45	0.6	0.5	0.6		
F	2.5		3.5		5.0	
φD'	φD+0.5max.					
L'	L+1.0max.		L+0.3max.		L+1.0max.	

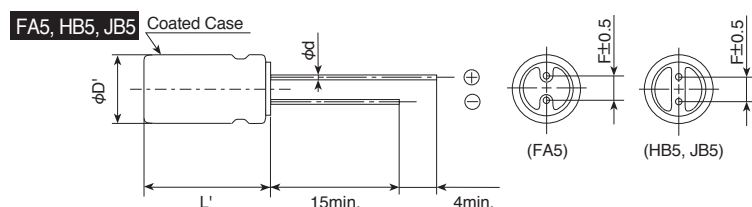

◆ MARKING

EX) 2.5V560μF

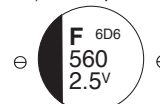

◆PART NUMBERING SYSTEM

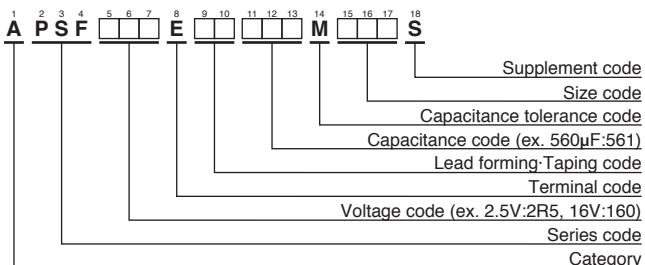

Please refer to "Product code guide (conductive polymer type)"

◆STANDARD RATINGS

WV(Vdc)	Cap(μF)	Case size φD×L(mm)	Leakage current (μAmax/after 2min.)	ESR (mΩ max./20°C, 100k to 300kHz)	Rated ripple current (mA _{rms} /105°C, 100kHz)	Part No.
2	1,000	6.3×8	500	5	5,900	APSF2R0E□□102MF08S
2.5	330	6.3×8	500	5	5,900	APSF2R5E□□331MF08S
	470	6.3×8	500	5	5,900	APSF2R5E□□471MF08S
	560	6.3×8	500	5	5,900	APSF2R5E□□561MF08S
	820	6.3×8	500	5	5,900	APSF2R5E□□821MF08S
	1,200	6.3×8	1,200	5	5,900	APSF2R5E□□122MF08S
	1,600	8×8	800	5	6,100	APSF2R5E□□162MH08S
4	470	6.3×8	500	5	5,900	APSF4R0E□□471MF08S
	560	6.3×8	500	5	5,900	APSF4R0E□□561MF08S
16	100	6.3×5	500	24	2,490	APSF160E□□101MF05S
	100	6.3×10.5	500	25	2,820	APSF160E□□101MFA5S
	270	8×8	864	10	5,000	APSF160E□□271MH08S
	270	8×11.5	864	11	5,080	APSF160E□□271MHB5S
	330	8×8	1,050	13	4,700	APSF160E□□331MH08S
	470	8×11.5	1,500	11	5,400	APSF160E□□471MHB5S
	470	10×11.5	1,500	10	6,100	APSF160E□□471MJB5S

□□ : Enter the appropriate lead forming or taping code.

NPCAP™-PSE Series

- Super low ESR, high ripple current capability
- Downsized from PSC series ($\phi 8 \times 8L$ to $\phi 6.3 \times 8L$)
- Endurance is longer life than PSC series (5,000 hours at 105°C)
- ESR after endurance is specified within the initial spec
- Rated voltage range : 2.5 to 6.3V_{dc}
- RoHS Compliant
- Halogen Free

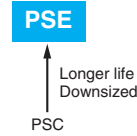

◆ SPECIFICATIONS

Items	Characteristics										
Category											
Temperature Range	-55 to +105°C										
Rated Voltage Range	2.5 to 6.3V _{dc}										
Capacitance Tolerance	±20% (M) (at 20°C, 120Hz)										
Surge Voltage	Rated voltage(V)×1.15 (at 105°C)										
Leakage Current	I=0.2CV or 500μA, whichever is greater (at 20°C after 2 minutes)										
*Note Where, I : Max. leakage current (μA), C : Nominal capacitance (μF), V : Rated voltage (V)											
Dissipation Factor (tanδ)	0.10 max. (at 20°C, 120Hz)										
Low Temperature Characteristics (Max.Impedance Ratio)	Z(-25°C)/Z(+20°C)≤1.15 Z(-55°C)/Z(+20°C)≤1.25 (at 100kHz)										
Endurance	The following specifications shall be satisfied when the capacitors are restored to 20°C after the rated voltage is applied for 5,000 hours at 105°C.										
	<table border="1"> <tr><td>Appearance</td><td>No significant damage</td></tr> <tr><td>Capacitance change</td><td>≤±20% of the initial value</td></tr> <tr><td>D.F. (tanδ)</td><td>≤The initial specified value</td></tr> <tr><td>ESR</td><td>≤The initial specified value</td></tr> <tr><td>Leakage current</td><td>≤The initial specified value</td></tr> </table>	Appearance	No significant damage	Capacitance change	≤±20% of the initial value	D.F. (tanδ)	≤The initial specified value	ESR	≤The initial specified value	Leakage current	≤The initial specified value
Appearance	No significant damage										
Capacitance change	≤±20% of the initial value										
D.F. (tanδ)	≤The initial specified value										
ESR	≤The initial specified value										
Leakage current	≤The initial specified value										
Bias Humidity Test	The following specifications shall be satisfied when the capacitors are restored to 20°C after subjecting them to DC voltage at 60°C, 90 to 95% RH for 1,000 hours.										
	<table border="1"> <tr><td>Appearance</td><td>No significant damage</td></tr> <tr><td>Capacitance change</td><td>≤±20% of the initial value</td></tr> <tr><td>D.F. (tanδ)</td><td>≤The initial specified value</td></tr> <tr><td>ESR</td><td>≤The initial specified value</td></tr> <tr><td>Leakage current</td><td>≤The initial specified value</td></tr> </table>	Appearance	No significant damage	Capacitance change	≤±20% of the initial value	D.F. (tanδ)	≤The initial specified value	ESR	≤The initial specified value	Leakage current	≤The initial specified value
Appearance	No significant damage										
Capacitance change	≤±20% of the initial value										
D.F. (tanδ)	≤The initial specified value										
ESR	≤The initial specified value										
Leakage current	≤The initial specified value										
Surge Voltage Test	The capacitors shall be subjected to 1,000 cycles each consisting of charge with the surge voltage specified at 105°C for 30 seconds through a protective resistor(R=1kΩ) and discharge for 5 minutes 30 seconds.										
	<table border="1"> <tr><td>Appearance</td><td>No significant damage</td></tr> <tr><td>Capacitance change</td><td>≤±20% of the initial value</td></tr> <tr><td>D.F. (tanδ)</td><td>≤The initial specified value</td></tr> <tr><td>ESR</td><td>≤The initial specified value</td></tr> <tr><td>Leakage current</td><td>≤The initial specified value</td></tr> </table>	Appearance	No significant damage	Capacitance change	≤±20% of the initial value	D.F. (tanδ)	≤The initial specified value	ESR	≤The initial specified value	Leakage current	≤The initial specified value
Appearance	No significant damage										
Capacitance change	≤±20% of the initial value										
D.F. (tanδ)	≤The initial specified value										
ESR	≤The initial specified value										
Leakage current	≤The initial specified value										
Failure Rate	0.5% per 1,000 hours maximum (Confidence level 60% at 105°C)										

*Note : If any doubt arises, measure the leakage current after the following voltage treatment.
Voltage treatment : DC rated voltage is applied to the capacitors for 120 minutes at 105°C.

◆ DIMENSIONS [mm]

● Terminal Code : E

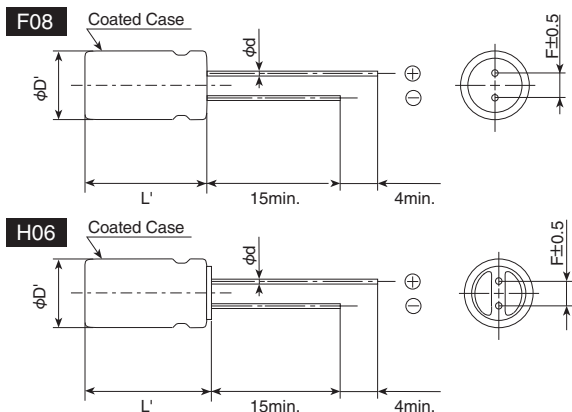

Size code	F08	H06
ϕD	6.3	8.0
ϕd	0.6	
F	2.5	3.5
$\phi D'$	$\phi D + 0.5 \text{max.}$	
L'	$L + 1.5 \text{max.}$	

◆ MARKING

EX) 2.5V820μF



◆PART NUMBERING SYSTEM

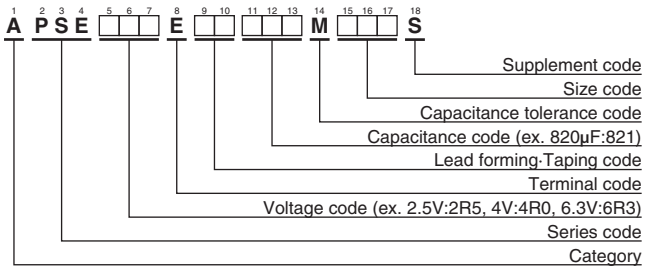

Please refer to "Product code guide (conductive polymer type)"

◆STANDARD RATINGS

WV(Vdc)	Cap(μF)	Case size φD×L(mm)	ESR (mΩ max./20°C, 100k to 300kHz)	Rated ripple current (mArms/105°C, 100kHz)	Part No.
2.5	680	8×6	8	4,900	APSE2R5E□□681MH06S
	820	6.3×8	7	5,000	APSE2R5E□□821MF08S
4	560	6.3×8	7	5,000	APSE4R0E□□561MF08S
	470	6.3×8	8	4,700	APSE6R3E□□471MF08S
6.3	560	6.3×8	8	4,700	APSE6R3E□□561MF08S

□□ : Enter the appropriate lead forming or taping code.

NPCAP™-PSC Series

- Super low ESR, high ripple current capability
- Lower profile than PSA ($\phi 8 \times 8L$ to $\phi 10 \times 12.5L$)
- Rated voltage range : 2.5 to 16V_{dc}
- Nominal capacitance range : 270 to 2,700 μ F
- Endurance : 2,000 hours at 105°C
- Suitable for DC-DC converters, voltage regulators and decoupling applications for computer motherboards
- Added 2.5V 820 μ F (ESR 5m Ω max.)
- RoHS Compliant

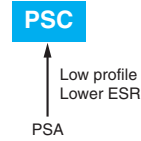

◆ SPECIFICATIONS

Items	Characteristics										
Category											
Temperature Range	-55 to +105°C										
Rated Voltage Range	2.5 to 16V _{dc}										
Capacitance Tolerance	±20% (M) (at 20°C, 120Hz)										
Surge Voltage	Rated voltage×1.15 (at 105°C)										
Leakage Current	I=0.2CV or 500 μ A, whichever is greater.										
*Note	Where, I : Max. leakage current (μ A), C : Nominal capacitance (μ F), V : Rated voltage (V _{dc}) (at 20°C after 2 minutes)										
Dissipation Factor (tan δ)	0.10 max. (at 20°C, 120Hz)										
Low Temperature Characteristics (Max.Impedance Ratio)	Z(-25°C)/Z(+20°C) ≤ 1.15 Z(-55°C)/Z(+20°C) ≤ 1.25 (at 100kHz)										
Endurance	The following specifications shall be satisfied when the capacitors are restored to 20°C after the rated voltage is applied for 2,000 hours at 105°C.										
	<table border="1"> <tr><td>Appearance</td><td>No significant damage</td></tr> <tr><td>Capacitance change</td><td>≤ ±20% of the initial value</td></tr> <tr><td>D.F. (tanδ)</td><td>≤ 150% of the initial specified value</td></tr> <tr><td>ESR</td><td>≤ 150% of the initial specified value</td></tr> <tr><td>Leakage current</td><td>≤ The initial specified value</td></tr> </table>	Appearance	No significant damage	Capacitance change	≤ ±20% of the initial value	D.F. (tan δ)	≤ 150% of the initial specified value	ESR	≤ 150% of the initial specified value	Leakage current	≤ The initial specified value
Appearance	No significant damage										
Capacitance change	≤ ±20% of the initial value										
D.F. (tan δ)	≤ 150% of the initial specified value										
ESR	≤ 150% of the initial specified value										
Leakage current	≤ The initial specified value										
Bias Humidity Test	The following specifications shall be satisfied when the capacitors are restored to 20°C after subjecting them to DC voltage at 60°C, 90 to 95% RH for 1,000 hours.										
	<table border="1"> <tr><td>Appearance</td><td>No significant damage</td></tr> <tr><td>Capacitance change</td><td>≤ ±20% of the initial value</td></tr> <tr><td>D.F. (tanδ)</td><td>≤ 150% of the initial specified value</td></tr> <tr><td>ESR</td><td>≤ 150% of the initial specified value</td></tr> <tr><td>Leakage current</td><td>≤ The initial specified value</td></tr> </table>	Appearance	No significant damage	Capacitance change	≤ ±20% of the initial value	D.F. (tan δ)	≤ 150% of the initial specified value	ESR	≤ 150% of the initial specified value	Leakage current	≤ The initial specified value
Appearance	No significant damage										
Capacitance change	≤ ±20% of the initial value										
D.F. (tan δ)	≤ 150% of the initial specified value										
ESR	≤ 150% of the initial specified value										
Leakage current	≤ The initial specified value										
Surge Voltage Test	The capacitors shall be subjected to 1,000 cycles each consisting of charge with the surge voltage specified at 105°C for 30 seconds through a protective resistor(R=1k Ω) and discharge for 5 minutes 30 seconds.										
	<table border="1"> <tr><td>Appearance</td><td>No significant damage</td></tr> <tr><td>Capacitance change</td><td>≤ ±20% of the initial value</td></tr> <tr><td>D.F. (tanδ)</td><td>≤ 150% of the initial specified value</td></tr> <tr><td>ESR</td><td>≤ 150% of the initial specified value</td></tr> <tr><td>Leakage current</td><td>≤ The initial specified value</td></tr> </table>	Appearance	No significant damage	Capacitance change	≤ ±20% of the initial value	D.F. (tan δ)	≤ 150% of the initial specified value	ESR	≤ 150% of the initial specified value	Leakage current	≤ The initial specified value
Appearance	No significant damage										
Capacitance change	≤ ±20% of the initial value										
D.F. (tan δ)	≤ 150% of the initial specified value										
ESR	≤ 150% of the initial specified value										
Leakage current	≤ The initial specified value										
Failure Rate	0.5% per 1,000 hours maximum (Confidence level 60% at 105°C)										

*Note : If any doubt arises, measure the leakage current after the following voltage treatment.
Voltage treatment : DC rated voltage is applied to the capacitors for 120 minutes at 105°C.

◆ DIMENSIONS [mm]

- Terminal Code : E

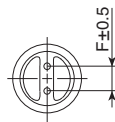
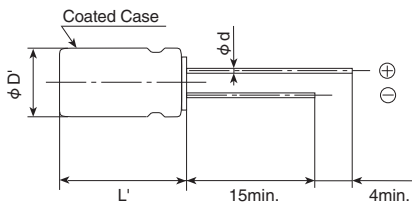

Size code	H08	HB5	JB5	JC5
ϕ D	8.0	8.0	10.0	10.0
ϕ d	0.6	0.8(Note1)	0.8(Note1)	0.6
F	3.5	3.5	5.0	5.0
ϕ D'	ϕ D+0.5max.			
L'	L+1.0max.	L+1.5max.		

Note1 : 0.6 for rated volt 16V.

◆ MARKING

EX) 2.5V820 μ F



◆PART NUMBERING SYSTEM

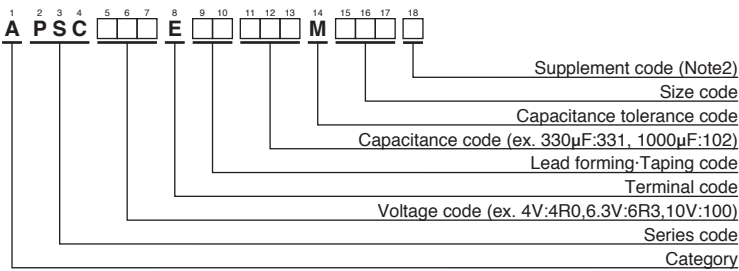

(Note2) PSC series, 2.5V820 μ F (ESR 5m Ω max.) has supplement code "J".
Can case, terminal and terminal plating are the same as all others in PSC series.

Please refer to "Product code guide (conductive polymer type)"

◆STANDARD RATINGS

WV(Vdc)	Cap(μ F)	Case size ϕ D \times L(mm)	ESR (m Ω max/20 $^{\circ}$ C, 100k to 300kHz)	Rated ripple current (mA _{rms} /105 $^{\circ}$ C, 100kHz)	Part No.
2.5	560	8 \times 8	7	6,100	APSC2R5E□□561MH08S
	820	8 \times 8	5	6,100	APSC2R5E□□821MH08J
	820	8 \times 8	7	6,100	APSC2R5E□□821MH08S
	1,000	8 \times 8	7	6,100	APSC2R5E□□102MH08S
	1,000	8 \times 11.5	7	6,100	APSC2R5E□□102MHB5S
	1,500	8 \times 11.5	7	6,100	APSC2R5E□□152MHB5S
	2,700	10 \times 11.5	8	5,560	APSC2R5E□□272MJB5S
4	560	8 \times 8	7	6,100	APSC4R0E□□561MH08S
	680	8 \times 11.5	7	6,100	APSC4R0E□□681MHB5S
	1,000	10 \times 11.5	6	6,640	APSC4R0E□□102MJB5S
6.3	470	8 \times 8	8	5,700	APSC6R3E□□471MH08S
	560	8 \times 8	8	5,700	APSC6R3E□□561MH08S
	820	10 \times 11.5	7	6,640	APSC6R3E□□821MJB5S
	1,500	10 \times 11.5	10	5,560	APSC6R3E□□152MJB5S
10	390	8 \times 11.5	9	5,650	APSC100E□□391MHB5S
	680	10 \times 11.5	7	6,100	APSC100E□□681MJB5S
16	270	8 \times 11.5	11	5,080	APSC160E□□271MHB5S
	330	10 \times 11.5	10	6,100	APSC160E□□331MJB5S
	330	10 \times 12.5	10	6,100	APSC160E□□331MJC5S
	470	10 \times 11.5	10	6,100	APSC160E□□471MJB5S

□□ : Enter the appropriate lead forming or taping code.

NPCAP™-PSA Series

- Super low ESR, high temperature resistance and high ripple current capability
- Rated voltage range : 2.5 to 16V_{dc}
- Endurance : 2,000 hours at 105°C
- Suitable for DC-DC converters, voltage regulators and decoupling applications for computer motherboards
- RoHS Compliant

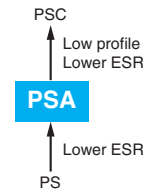

◆ SPECIFICATIONS

Items	Characteristics										
Category											
Temperature Range	-55 to +105°C										
Rated Voltage Range	2.5 to 16V _{dc}										
Capacitance Tolerance	±20% (M) (at 20°C, 120Hz)										
Surge Voltage	Rated voltage×1.15 (at 105°C)										
Leakage Current	I=0.2CV										
*Note	Where, I : Max. leakage current (μA), C : Nominal capacitance (μF), V : Rated voltage (V _{dc}) (at 20°C after 2 minutes)										
Dissipation Factor (tanδ)	0.08 max. (FA5 size : 0.12max.) (at 20°C, 120Hz)										
Low Temperature Characteristics (Max. Impedance Ratio)	Z(-25°C)/Z(+20°C) ≤ 1.15 Z(-55°C)/Z(+20°C) ≤ 1.25 (at 100kHz)										
Endurance	The following specifications shall be satisfied when the capacitors are restored to 20°C after the rated voltage is applied for 2,000 hours at 105°C.										
	<table border="1"> <tr> <td>Appearance</td> <td>No significant damage</td> </tr> <tr> <td>Capacitance change</td> <td>≤ ±20% of the initial value</td> </tr> <tr> <td>D.F. (tanδ)</td> <td>≤ 150% of the initial specified value</td> </tr> <tr> <td>ESR</td> <td>≤ 150% of the initial specified value</td> </tr> <tr> <td>Leakage current</td> <td>≤ The initial specified value</td> </tr> </table>	Appearance	No significant damage	Capacitance change	≤ ±20% of the initial value	D.F. (tanδ)	≤ 150% of the initial specified value	ESR	≤ 150% of the initial specified value	Leakage current	≤ The initial specified value
Appearance	No significant damage										
Capacitance change	≤ ±20% of the initial value										
D.F. (tanδ)	≤ 150% of the initial specified value										
ESR	≤ 150% of the initial specified value										
Leakage current	≤ The initial specified value										
Bias Humidity Test	The following specifications shall be satisfied when the capacitors are restored to 20°C after subjecting them to DC voltage at 60°C, 90 to 95% RH for 1,000 hours.										
	<table border="1"> <tr> <td>Appearance</td> <td>No significant damage</td> </tr> <tr> <td>Capacitance change</td> <td>≤ ±20% of the initial value</td> </tr> <tr> <td>D.F. (tanδ)</td> <td>≤ 150% of the initial specified value</td> </tr> <tr> <td>ESR</td> <td>≤ 150% of the initial specified value</td> </tr> <tr> <td>Leakage current</td> <td>≤ The initial specified value</td> </tr> </table>	Appearance	No significant damage	Capacitance change	≤ ±20% of the initial value	D.F. (tanδ)	≤ 150% of the initial specified value	ESR	≤ 150% of the initial specified value	Leakage current	≤ The initial specified value
Appearance	No significant damage										
Capacitance change	≤ ±20% of the initial value										
D.F. (tanδ)	≤ 150% of the initial specified value										
ESR	≤ 150% of the initial specified value										
Leakage current	≤ The initial specified value										
Surge Voltage Test	The capacitors shall be subjected to 1,000 cycles each consisting of charge with the surge voltage specified at 105°C for 30 seconds through a protective resistor (R=1kΩ) and discharge for 5 minutes 30 seconds.										
	<table border="1"> <tr> <td>Appearance</td> <td>No significant damage</td> </tr> <tr> <td>Capacitance change</td> <td>≤ ±20% of the initial value</td> </tr> <tr> <td>D.F. (tanδ)</td> <td>≤ 150% of the initial specified value</td> </tr> <tr> <td>ESR</td> <td>≤ 150% of the initial specified value</td> </tr> <tr> <td>Leakage current</td> <td>≤ The initial specified value</td> </tr> </table>	Appearance	No significant damage	Capacitance change	≤ ±20% of the initial value	D.F. (tanδ)	≤ 150% of the initial specified value	ESR	≤ 150% of the initial specified value	Leakage current	≤ The initial specified value
Appearance	No significant damage										
Capacitance change	≤ ±20% of the initial value										
D.F. (tanδ)	≤ 150% of the initial specified value										
ESR	≤ 150% of the initial specified value										
Leakage current	≤ The initial specified value										
Failure Rate	0.5% per 1,000 hours maximum (Confidence level 60% at 105°C)										

*Note : If any doubt arises, measure the leakage current after the following voltage treatment.
Voltage treatment : DC rated voltage is applied to the capacitors for 120 minutes at 105°C.

◆ DIMENSIONS [mm]

- Terminal Code : E

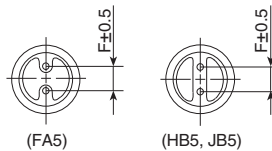
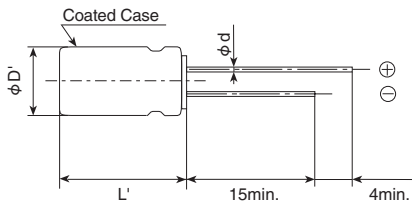

Size code	FA5	HB5	JB5
φ D	6.3	8.0	10.0
φ d	0.5	0.8	
F	2.5	3.5	5.0
φ D'	φ D+0.5max		
L'	L+0.3max	L+1.5max	

◆ MARKING

EX) 4V560μF



NPCAP™-PSA Series

◆PART NUMBERING SYSTEM

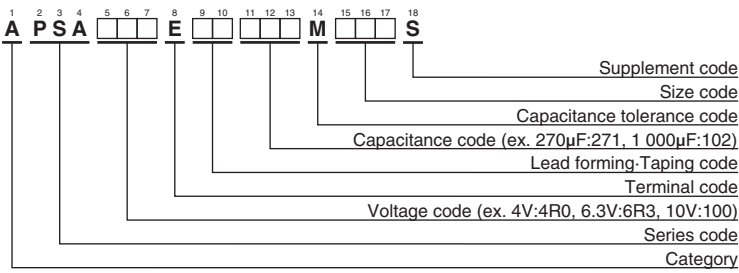

Please refer to "Product code guide (conductive polymer type)"

◆STANDARD RATINGS

WV(Vdc)	Cap(μF)	Case size φD×L(mm)	ESR (mΩ max/20°C, 100k to 300kHz)	Rated ripple current (mArms/105°C, 100kHz)	Part No.
2.5	390	6.3×10.5	20	3,160	APSA2R5E□□391MFA5S
	680	8×11.5	7	5,580	APSA2R5E□□681MHB5S
	820	8×11.5	7	5,580	APSA2R5E□□821MHB5S
	1,000	10×11.5	6	5,860	APSA2R5E□□102MJB5S
	1,500	10×11.5	7	5,860	APSA2R5E□□152MJB5S
4	270	6.3×10.5	20	3,160	APSA4R0E□□271MFA5S
	390	6.3×10.5	24	3,300	APSA4R0E□□391MFA5S
	560	8×11.5	7	5,580	APSA4R0E□□561MHB5S
	820	10×11.5	6	5,860	APSA4R0E□□821MJB5S
6.3	220	6.3×10.5	20	3,160	APSA6R3E□□221MFA5S
	330	6.3×10.5	28	3,190	APSA6R3E□□331MFA5S
	390	8×11.5	8	5,080	APSA6R3E□□391MHB5S
	470	8×11.5	7	5,700	APSA6R3E□□471MHB5S
	680	10×11.5	7	5,860	APSA6R3E□□681MJB5S
10	47	6.3×10.5	25	2,820	APSA100E□□470MFA5S
	68	6.3×10.5	25	2,820	APSA100E□□680MFA5S
	100	6.3×10.5	25	2,820	APSA100E□□101MFA5S
	150	6.3×10.5	25	2,820	APSA100E□□151MFA5S
	270	8×11.5	9	4,710	APSA100E□□271MHB5S
	470	10×11.5	8	5,650	APSA100E□□471MJB5S
16	100	6.3×10.5	25	2,820	APSA160E□□101MFA5S

□□ : Enter the appropriate lead forming or taping code.

NPCAP™-PS Series

- Super low ESR, high temperature resistance
- Large capacitance & Improved high ripple current capability
- Rated voltage range : 2.5 to 35V_{dc}
- Endurance : 2,000 hours at 105°C
- Suitable for DC-DC converters, voltage regulators and decoupling applications
For computer motherboards
- RoHS Compliant

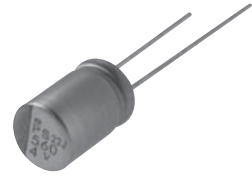
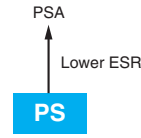

◆ SPECIFICATIONS

Items	Characteristics										
Category Temperature Range	-55 to +105°C										
Rated Voltage Range	2.5 to 35V _{dc}										
Capacitance Tolerance	±20% (M) (at 20°C, 120Hz)										
Surge Voltage	Rated voltage×1.15 (at 105°C)										
Leakage Current *Note	I=0.2CV (Rated voltage 2.5 to 25V _{dc}) / I=0.5CV (Rated voltage 35V _{dc}) Where, I : Max. leakage current (μA), C : Nominal capacitance (μF), V : Rated voltage (V _{dc}) (at 20°C after 2 minutes)										
Dissipation Factor (tanδ)	0.12 max. (at 20°C, 120Hz)										
Low Temperature Characteristics (Max. Impedance Ratio)	Z(-25°C)/Z(+20°C) ≤ 1.15 Z(-55°C)/Z(+20°C) ≤ 1.25 (at 100kHz)										
Endurance	The following specifications shall be satisfied when the capacitors are restored to 20°C after the rated voltage is applied for 2,000 hours at 105°C.										
	<table border="1"> <tr> <td>Appearance</td> <td>No significant damage</td> </tr> <tr> <td>Capacitance change</td> <td>≤ ±20% of the initial value</td> </tr> <tr> <td>D.F. (tanδ)</td> <td>≤ 150% of the initial specified value</td> </tr> <tr> <td>ESR</td> <td>≤ 150% of the initial specified value</td> </tr> <tr> <td>Leakage current</td> <td>≤ The initial specified value</td> </tr> </table>	Appearance	No significant damage	Capacitance change	≤ ±20% of the initial value	D.F. (tanδ)	≤ 150% of the initial specified value	ESR	≤ 150% of the initial specified value	Leakage current	≤ The initial specified value
Appearance	No significant damage										
Capacitance change	≤ ±20% of the initial value										
D.F. (tanδ)	≤ 150% of the initial specified value										
ESR	≤ 150% of the initial specified value										
Leakage current	≤ The initial specified value										
Bias Humidity Test	The following specifications shall be satisfied when the capacitors are restored to 20°C after subjecting them to DC voltage at 60°C, 90 to 95% RH for 1,000 hours.										
	<table border="1"> <tr> <td>Appearance</td> <td>No significant damage</td> </tr> <tr> <td>Capacitance change</td> <td>≤ ±20% of the initial value</td> </tr> <tr> <td>D.F. (tanδ)</td> <td>≤ 150% of the initial specified value</td> </tr> <tr> <td>ESR</td> <td>≤ 150% of the initial specified value</td> </tr> <tr> <td>Leakage current</td> <td>≤ The initial specified value</td> </tr> </table>	Appearance	No significant damage	Capacitance change	≤ ±20% of the initial value	D.F. (tanδ)	≤ 150% of the initial specified value	ESR	≤ 150% of the initial specified value	Leakage current	≤ The initial specified value
Appearance	No significant damage										
Capacitance change	≤ ±20% of the initial value										
D.F. (tanδ)	≤ 150% of the initial specified value										
ESR	≤ 150% of the initial specified value										
Leakage current	≤ The initial specified value										
Surge Voltage Test	The capacitors shall be subjected to 1,000 cycles each consisting of charge with the surge voltage specified at 105°C for 30 seconds through a protective resistor (R=1kΩ) and discharge for 5 minutes 30 seconds.										
	<table border="1"> <tr> <td>Appearance</td> <td>No significant damage</td> </tr> <tr> <td>Capacitance change</td> <td>≤ ±20% of the initial value</td> </tr> <tr> <td>D.F. (tanδ)</td> <td>≤ 150% of the initial specified value</td> </tr> <tr> <td>ESR</td> <td>≤ 150% of the initial specified value</td> </tr> <tr> <td>Leakage current</td> <td>≤ The initial specified value</td> </tr> </table>	Appearance	No significant damage	Capacitance change	≤ ±20% of the initial value	D.F. (tanδ)	≤ 150% of the initial specified value	ESR	≤ 150% of the initial specified value	Leakage current	≤ The initial specified value
Appearance	No significant damage										
Capacitance change	≤ ±20% of the initial value										
D.F. (tanδ)	≤ 150% of the initial specified value										
ESR	≤ 150% of the initial specified value										
Leakage current	≤ The initial specified value										
Failure Rate	0.5% per 1,000 hours maximum (Confidence level 60% at 105°C)										

*Note : If any doubt arises, measure the leakage current after the following voltage treatment.
Voltage treatment : DC rated voltage is applied to the capacitors for 120 minutes at 105°C.

◆ DIMENSIONS [mm]

- Terminal Code : E

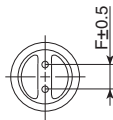
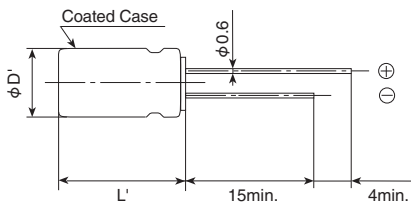

Size code	HB5	JC5
φ D	8	10
φ d		0.6
F	3.5	5.0
φ D'	φ D+0.5max	
L'	L+1.5max.	

◆ MARKING

EX) 4V820μF



◆PART NUMBERING SYSTEM

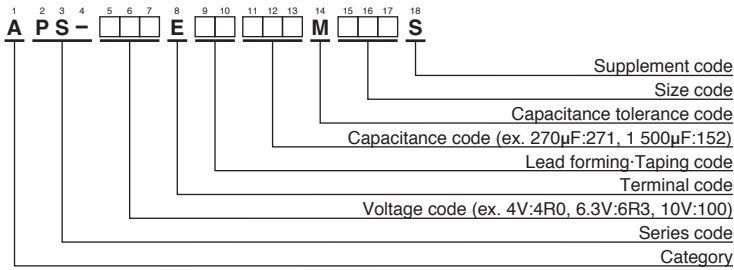

Please refer to "Product code guide (conductive polymer type)"

◆STANDARD RATINGS

WV(V _{dc})	Cap(μF)	Case size φD×L(mm)	ESR (mΩ _{max} /20°C, 100k to 300kHz)	Rated ripple current (mA _{rms} /105°C, 100kHz)	Part No.
2.5	680	8×11.5	10	5,230	APS-2R5E□□681MHB5S
	820	8×11.5	10	5,230	APS-2R5E□□821MHB5S
	1,500	10×12.5	8	5,500	APS-2R5E□□152MJC5S
4	560	8×11.5	10	5,230	APS-4R0E□□561MHB5S
	820	10×12.5	8	5,500	APS-4R0E□□821MJC5S
	1,000	10×12.5	8	5,500	APS-4R0E□□102MJC5S
	1,200	10×12.5	8	5,500	APS-4R0E□□122MJC5S
6.3	390	8×11.5	12	4,770	APS-6R3E□□391MHB5S
	470	8×11.5	12	4,770	APS-6R3E□□471MHB5S
	680	10×12.5	10	5,500	APS-6R3E□□681MJC5S
	820	10×12.5	10	5,500	APS-6R3E□□821MJC5S
	1,000	10×12.5	10	5,500	APS-6R3E□□102MJC5S
10	270	8×11.5	14	4,420	APS-100E□□271MHB5S
	330	8×11.5	14	4,420	APS-100E□□331MHB5S
	470	10×12.5	12	5,300	APS-100E□□471MJC5S
	560	10×12.5	12	5,300	APS-100E□□561MJC5S
16	100	8×11.5	16	4,360	APS-160E□□101MHB5S
	180	8×11.5	16	4,360	APS-160E□□181MHB5S
	270	10×12.5	14	5,050	APS-160E□□271MJC5S
	330	10×12.5	14	5,050	APS-160E□□331MJC5S
20	100	8×11.5	24	3,320	APS-200E□□101MHB5S
	150	10×12.5	20	4,320	APS-200E□□151MJC5S
25	68	8×11.5	24	3,320	APS-250E□□680MHB5S
	100	10×12.5	20	4,320	APS-250E□□101MJC5S
35	18	8×11.5	34	2,830	APS-350E□□180MHB5S
	33	10×12.5	30	3,270	APS-350E□□330MJC5S

□□ : Enter the appropriate lead forming or taping code.

RECOMMENDED SOLDERING CONDITIONS FOR NPCAP™

◆ SURFACE MOUNT TYPE

The following conditions are recommended for air or infrared reflow soldering PXG/PXK/PXS/PXF/PXE/PXA/PXD/PXH series onto a glass epoxy circuit board of 90×50×0.8mm (with resist) by cream solder. The temperatures shown are the surface temperature values on the top of the can and temperature of capacitor terminal.

Reflow should be performed twice or less.

Please ensure that the capacitor became cold enough to the room temperature (5 to 35°C) before the second reflow.

● Recommended soldering heat conditions

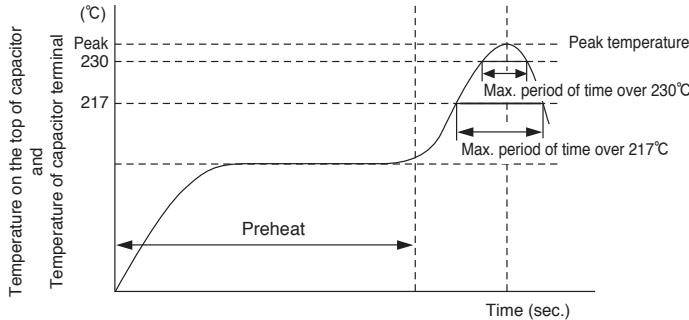

Voltage range (V _{dc})	Preheat	Time maintained above 217°C	Time maintained above 230°C	Peak temp.	Reflow number
2.5 to 16V	150 to 180°C 120 sec.max.	50 sec.max.	40 sec.max.	260°Cmax. 250°Cmax.	1-cycle only 2-cycle allowed
20 to 25V		50 sec.max. (40 sec.max.)	40 sec.max. (30 sec.max.)	250°Cmax. (240°Cmax.)	1-cycle only 2-cycle allowed
		40 sec.max.	30 sec.max.		

() : Applies for 20V 82μF(J80) and 25V 39μF(J80)

● Recommended Solder Land on PC Board

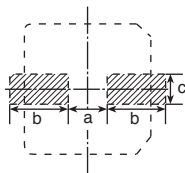

■ Solder land on PC board

	[mm]		
Size code	a	b	c
D55	1.0	2.6	1.6
E46, E60, E61	1.4	3.0	1.6
F46, F55 F60, F61, F80	1.9	3.5	1.6
H70, H80, HA0, HC0	3.1	4.2	2.2
J80, JA0, JC0	4.5	4.4	2.2

◆ RADIAL LEAD TYPE

● Recommended soldering heat conditions

Preheat : 150°C 120 seconds max.

Flow soldering : 260+5°C max. 10+1 seconds max.

◆ PRECAUTIONS FOR USERS

Soldering method

SMD type have no capability to withstand such dip or wave soldering as totally immersing components into a solder bath.

Reflow soldering

Reflow the capacitors within Recommended Reflow Soldering Conditions. Verify there is no temperature stress to the capacitors because the following differences might degrade capacitors electrically and mechanically. Please consult with us if other reflow conditions are employed.

1. Location of components : Temperature increases at the edge of PC board more than the center.
2. Population of PC board : The lower the component population is, the more temperature rises.
3. Material of PC board : A ceramic-made board needs more heat than a glass epoxy-made board. The heat increase may cause damage to the capacitors.
4. Thickness of PC board : A thicker board needs more heat than a thinner board. The heat may damage the capacitors.
5. Size of PC board : A larger board needs more heat than a smaller board. The heat may damage the capacitors.
6. Solder thickness
If very thin cream solder paste is to be used for SMD types, please consult with us.
7. Location of infrared ray lamps : IR reflow as well as hot plate reflow heats only on the reverse side of the PC board to lessen heat stress to the capacitors.
8. Case leakage current will increase (~mA) after the reflow process, the leakage current which rose gradually decreases when voltage is applied.
9. Vapor phase soldering (VPS) is not used.

Rework of soldering

Use a soldering iron for rework. Do not exceed an iron tip temperature of 380±10°C and an exposure time of 3±0.5 seconds.

Mechanical stress

Do not grab the capacitors to lift the PC board and give stress to the capacitor. Avoid bending the PC board. This may damage the capacitors.

Cleaning assembly board

Immediately after solvent cleaning, remove residual solvent with an air knife for at least 10 minutes. If the solvent is insufficiently dry, the capacitors may corrode.

Coating on assembly board

1. Before curing coating material, remove the cleaning solvents from the assembly board.
2. Before conformal coating, a chloride free pre-coat material is recommended to decrease the stress on the capacitors.

Molding with resin

Internal chemical reaction gradually produces gas in the capacitor; increasing internal pressure. If the end seal of the capacitor is completely covered by resin the gas will be unable to escape causing a potentially dangerous situation. The chlorine in resin will penetrate the end seal, reach the element, and damage of the capacitor.

Glue

The followings are requirements for glue.

1. A low curing temperature over a short period of time
2. Strong adhesion and heat resistance after curing
3. Long shelf life
4. No corrosion

Others

Refer to PRECAUTIONS AND GUIDELINES(Conductive Polymer).

Aluminum Electrolytic Capacitors

For Conductive Polymer Aluminum Solid Electrolytic Capacitors, see Precautions and Guidelines (Conductive Polymer Aluminum Solid Electrolytic Capacitors)

1) Device circuits design considerations

1) Confirm installation and operating requirements for capacitors, then use them within the performance limits prescribed in this catalog or product specifications.

2) Polarity

Aluminum electrolytic capacitors are polarized. Never apply a reverse voltage or AC voltage. Connecting with wrong polarity will short-circuit or damage the capacitor with the pressure relief vent opening early on. To identify the polarity of a capacitor, see the relevant diagram in the catalogs or product specifications, or the polarity marking on the body of the capacitor. Incidentally, the rubber end seal bungs of the radial lead type capacitors have a solder-flux gas escaping configuration, which is nothing to do with the polarity of the capacitors. For circuits where the polarity is occasionally reversed, use a bi-polar type of aluminum electrolytic capacitor. However, note that even bi-polar type capacitors must not be used for AC circuits.

3) Operating voltage

Do not apply an over-voltage that exceeds a rated voltage specified for the capacitors. The total peak value of the ripple voltage plus the DC voltage must not exceed the rated voltage of the capacitors. Although capacitors specify a surge voltage that exceeds the full rated voltage, it does not assure long-term use but limited use under specific conditions.

4) Ripple current

Do not apply an overcurrent that exceeds the rated ripple current specified for the capacitors. Excessive ripple current will increase heat production within the capacitors, causing the capacitors to be damaged as follows:

- Shorten lifetime
- Open pressure relief vent
- Short circuit

The rated ripple current is specified along with a specific ripple frequency.

Where using the capacitors at any other ripple frequency other than the specified frequency, calculate the allowable ripple current by multiplying the rated ripple current by a frequency compensation factor (Frequency Multiplier) specified for each product series.

5) Operating temperature (Category temperature)

Do not apply high temperatures that exceed the upper limit of the category temperature range specified for the capacitors. Using the capacitor at temperatures higher than the upper limit will considerably shorten the lifetime of the capacitor and make the pressure relief vent open. In other words, lowering ambient temperatures will extend the expected lifetime of the capacitors.

6) Lifetime

Select the capacitors to meet the service life requirements of a device.

7) Charging and discharging

Do not use capacitors in circuits intended for rapid charge and discharge cycle operations.

If capacitors are used in the circuits that repeat a charge and discharge with a large voltage drop or a rapid charge and discharge at a short interval cycle, capacitance will decrease and/or the capacitors will be damaged by internal heat generation.

Consult us for a heavy charge and discharge type of capacitor so that the capacitor will be designed in accordance with requirements of duty cycle of charge and discharge, the number of cycles, discharging resistance and operating temperatures.

8) Failure mode of capacitors

Non-solid aluminum electrolytic capacitors have a limited lifetime which ends in an open circuit failure mode, in general. Depending on the product type and operating conditions, the failure mode may involve in opening of the pressure relief vent.

9) Capacitor insulation

Electrically isolate the following sections of a capacitor from the negative terminal, the positive terminal and the circuit patterns.

- The outer can case of a non-solid aluminum capacitor.
- The dummy terminal of a snap-in type non-solid aluminum capacitor, which is designed for mounting stability.

10) Outer sleeve

The outer sleeve of a capacitor does not assure electrical insulation (except for screw-terminal type capacitors). It should not be used where electrical insulation is required.

11) Operating conditions

Do not use/expose capacitors to the following conditions:

- ① Direct contact with water, salt water or oil, or high condensation environment.
- ② Direct sunlight.
- ③ Toxic gases such as hydrogen sulfide, sulfurous acid, nitrous acid, chlorine and its compounds, bromine and its compounds and ammonium.
- ④ Ozone, ultraviolet rays or radiation.
- ⑤ Extreme vibration or mechanical shock that exceeds limits in the catalogs or product specifications.

12) Mounting

① Non-solid aluminum electrolytic capacitors contain paper separators and electric-conductive electrolyte that contains organic solvent as main solvent material, both of which are flammable. If the electrolyte leaks onto a printed circuit board, it can erode the device circuit pattern, may short-circuit the copper traces, smoke and burn. Make sure of designing a PC board as follows:

- Provide the appropriate hole spacing on the PC board to match the terminal spacing of a capacitor.
- Provide the following adequate clearance space over the pressure relief vent of a capacitor to avoid blocking the correct opening of the pressure relief vent.

Case diameter	Clearance
φ 8(6.3) to φ 16mm:	2mm minimum
φ 18 to φ 35mm:	3mm minimum
φ 40 mm and above:	5mm minimum

- Do not locate any wire or circuit pattern over the pressure relief vent of a capacitor.
 - If a capacitor is mounted with its pressure relief vent facing down on the PC board, provide a ventilation hole in the board beneath it to let gas escape when the vent opens.
 - Do not print any copper trace under the seal (terminal) side of a capacitor. Copper traces should be 1 mm (preferably 2mm or more) spaced apart from the side of the capacitor body.
 - Avoid locating any heat source components near capacitors or on the opposite side of the PC board under capacitors.
 - In designing a double-sided PC board, do not locate any through-hole via or unnecessary hole underneath a capacitor.
 - In designing a double-sided PC board, do not print any circuit pattern underneath a capacitor.
- ② For a screw terminal type capacitor, tightening the terminal screws and the mounting clamp should be within the maximum torque specified in the catalogs or product specifications. Do not mount a screw terminal type capacitor with the terminals facing downward. Also, if the body of a capacitor is installed horizontally such as being laid on its side, do not position the pressure relief vent downward.
- ③ For a chip type capacitor, design the land patterns of the PC board in accordance with the recommended footprint dimensions described in the catalogs or product specifications.

13) Using capacitors for significantly safety-oriented applications

Consult us about capacitors for a device application affecting human safety (①Aviation and space, ②Nuclear, ③Medical and ④Vehicle) or for any device whose failure will make an impact on society. Note that some products such as photoflash use capacitors which have been designed for specific applications cannot be used for any other application.

14) Others

Design device circuits taking into consideration the following conditions:

- ① Electrical characteristics of a capacitor depend on the temperature and frequency. In designing the device circuits, consider the change in the characteristics.
- ② If using more than one capacitor connected in parallel, design the device circuits to balance the current flow in individual capacitors.
- ③ If using more than one capacitor connected in series, connect shunting resistors in parallel with the individual capacitors to balance the voltage.

2 | Installation

1) Assembling

- ① Do not try to reuse the capacitors once assembled and electrified, except only capacitors that are taken from a device for periodic inspection to measure their electrical characteristics.
- ② Capacitors may have been spontaneously recharged with time by a recovery voltage phenomenon. In this case, discharge the capacitors through a resistor of approximately 1kΩ before use.
- ③ If non-solid aluminum electrolytic capacitors have been stored at any conditions more than 35°C and 75%RH for long storage periods of time more than the limits specified in the catalogs or product specifications, they may have high leakage current. In this case, make pre-conditioning by applying the rated voltage through a resistor of approximately 1kΩ.
- ④ Confirm the rated capacitance and voltage of capacitors before installation.
- ⑤ Confirm the polarity of capacitors before installation.
- ⑥ Do not try to use the capacitors that were dropped to the floor and so forth.
- ⑦ Do not deform the can case of a capacitor.
- ⑧ Make sure that the terminal spacing of a capacitor equals the holes spacing on the PC board before installing the capacitor. For radial lead type capacitors, some standard pre-formed lead types are also available.
- ⑨ When installing a snap-in type capacitor on the PC board, insert the terminals into the holes and press the capacitor down until the body is settled flush on the surface of the PC board (without the body standing off).
- ⑩ Do not apply excessive mechanical force to capacitors more than the limits prescribed in the catalogs or product specifications. Avoid excessive mechanical force while the capacitors are in the process of vacuum-picking, placing and positioning by automatic mounting machines or cutting the lead wires by automatic insertion machines.

2) Soldering and heat resistance

- ① For soldering using a soldering iron, consider the following conditions:
 - Soldering conditions (temperature and time) should be within the limits prescribed in the catalogs or product specifications.
 - If it is necessary to pre-form the terminal spacing of a capacitor to match the hole spacing on the PC board before assembly and soldering, do not make mechanical stress reach into the body of the capacitor but only the lead wires.
 - Do not touch the body of a capacitor with the hot tip of the soldering iron.
- ② For flow soldering, consider the following conditions:
 - Do not dip the body of a capacitor into a solder bath. Expose only the terminals to the melt solder with the PC board interposing between the solder and the body of the capacitor. Solder only the reverse side of the PC board where the body of the capacitor is not located.

- Soldering conditions should be within the limits prescribed in the catalogs or product specifications.
 - Do not apply flux to any part of a capacitor other than the terminals.
 - Do not let any other component lean against nor come into contact with the capacitor while soldering.
- ③ For reflow soldering, consider the following conditions:
 - Soldering conditions (preheat, reflow temperature and time) should be within the limits prescribed in the catalogs or product specifications.
 - When using the infrared heater and setting its temperatures, adjust the heating levels taking into consideration that the color and materials of a capacitor vary in their infrared absorbance.
 - The allowable number of reflow passes is specified in the catalogs or product specifications.
 - When mounting a capacitor on the double-sided PC board, do not place any wiring pattern underneath the capacitor.
 - Avoid using Vapor Phase Soldering (VPS) system reflow.
 - ④ Do not try to reuse the capacitor that was removed from the PC board after soldering.
 - ⑤ Only use chip type capacitors for reflow soldering. The other type capacitors are not designed for the reflow.

3) Handling after soldering

After soldering the PC board, do not apply the following mechanical stress to the capacitor:

- ① Do not tilt, push down or twist the body of the capacitor.
- ② Do not grab the body of the capacitor to carry the assembly board.
- ③ Do not hit anything against the capacitor. When stacking the assembled boards, do not put any of the PC boards or other components against the capacitor.
- ④ Do not drop the assembled board.

4) Cleaning assembly boards

- ① Do not clean capacitors with the following cleaning agents:
 - Halogenated solvents: cause capacitor failures due to corrosion.
 - Alkali system solvents: corrode (dissolve) the aluminum can case.
 - Terpene and petroleum system solvents: deteriorate the rubber seal materials.
 - Xylene: deteriorates the rubber seal materials as well.
 - Acetone: erases the markings printed on a capacitor.

Where cleaning is necessary, use only solvent resistant type capacitors that have been assured for the cleaning within the specific cleaning conditions prescriber in the catalogs or product specifications. In particular, carefully set up the conditions for ultrasonic cleaning system.
- ② Where cleaning the solvent resistance type of aluminum electrolytic capacitors, confirm the following conditions:
 - Control the contamination (the conductivity, pH, specific gravity, water content, etc.) of the cleaning agents.
 - After the cleaning, do not leave the capacitors (assembly boards) in an environment of cleaning agent-rich or in a closed container. Sufficiently evaporate the residual cleaning agent from the assembly boards and the capacitors by forced hot air at temperatures less than the upper limit of category temperature range for more than 10 minutes.

In general, aluminum electrolytic capacitors are sensitive to contamination of halogen ions (particularly to chlorine ions). Depending on the properties of the electrolyte and rubber seal materials used in a capacitor, the halogen ions lead up to catastrophic failures on the capacitor. Where the inside of a capacitor has been contaminated with more than a certain amount of halogen ions and the capacitor is in use, the corrosion reaction of aluminum occurs. The corrosion causes the capacitor to have a significant increase in leakage current with heat produced, open the pressure relief vent and become open circuit mode failure.

Due to global environmental issues (greenhouse effects and other environmental destruction by depletion of the ozone layer), the conventional cleaning solvents of CFC 113, Trichloroethylene and 1,1,1-trichloroethylene were replaced by substitutes.

The following are some substitute cleaning agents and allowable cleaning conditions:

- a) Fatty-alcohol cleaning agents
 Pine Alpha ST-100S (Arakawa Chemical)
 Clean Through 750H, 750K, 750L and 710M (Kao)
 Technocare FRW-14, 15, 16 and 17 (Momentive Performance Materials)

[Cleaning conditions]

Either of immersion or ultrasonic cleaning, for a maximum of 10 minutes and at a maximum liquid temperature of 60°C is acceptable. Make sure that the markings on the capacitor are not rubbed against any other component or the PC board during cleaning. Note that shower cleaning affects the markings on the capacitor.

- b) HCFC (Freon 225) as Alternative CFCs
 AK225AES (Asahi Glass)

[Cleaning conditions]

Solvent resistant type capacitors, which were originally developed to intend to resist Freon TE or Freon TES, are also capable of withstanding any one of immersion, ultrasonic or vapor cleaning, for a maximum of 5 minutes (or 2 minutes for KRE and KRE-BP series capacitors or 3 minutes for SRM series). However, this type of cleaning agent is not recommended to use, as the cleaning materials may be banned in near future in view of global environmental issues.

- c) IPA (Isopropyl Alcohol)

Immersion cleaning with a maximum flux concentration of 2 wt% is acceptable.

5) Adhesives and coating materials

- ① Do not use any adhesive or coating materials containing halogenated solvents.
- ② Make sure of the following conditions before applying adhesive or coating materials to a capacitor,
 - No flux residue nor stain is left between the rubber seal of a capacitor and PC board.
 - Dry the capacitor to remove residual cleaning agents before applying adhesive and coating materials. Do not cover up the entire surface of the rubber seal of the capacitor with adhesives or coating materials.
 - Heating and curing conditions for adhesives and coating materials should be followed as prescribed in the catalogs or product specifications.
 - Covering up the entire surface of the rubber seal with resin mold materials will obstruct the normal diffusion of internal hydrogen gas from a capacitor and result in serious failures. Also, where the adhesive and coating materials contain a large amount of halogen ions, the halogen ions will contaminate the inside of the capacitor through the rubber seal materials, causing the capacitor to become a failure.
 - Depending on solvent materials that the adhesive or coating materials contains, note that the outer sleeve of a capacitor may lose a gloss or whiten in appearance.

6) Fumigation

In exporting or importing electronic devices, they may be exposed to fumigation with halide such as methyl bromide. Where aluminum electrolytic capacitors are exposed to halide such as methyl bromide, the capacitors will be damaged with the corrosion reaction with halogen ions in the same way as cleaning agents. For the export and import, Nippon Chemi-Con considers using some packaging method and so forth so that fumigation is not required. For customers to export or import electronic devices, semi-assembly products or capacitor components, confirm if they will be exposed to fumigation and also consider final condition of packaging. (Note that either cardboard or vinyl package has a risk of fumigation gas penetration.)

3) Precautions during operation of devices

- 1) Never touch the terminals of a capacitor directly with bare hands.
- 2) Do not short-circuit between the capacitor terminals with anything conductive.
 Also, do not spill any conductive liquid such as acid or alkaline solution over a capacitor.
- 3) Confirm environmental conditions where the device will be placed. Do not use the device in the following environmental conditions:
 - ① Water or oil spatters, or high condensation environment.
 - ② Direct sunlight.
 - ③ Ozone, ultraviolet rays or radiation.
 - ④ Toxic gases such as hydrogen sulfide, sulfuric acid, nitrous acid, chlorine and its compounds, bromine and its compounds and ammonium.
 - ⑤ Extreme vibration or mechanical shock that exceeds the limits in the catalogs or product specifications.

4) Maintenance inspections

- 1) For industrial use capacitors, make periodic inspections of the capacitors. Before the inspections, turn off the power supply of the device and discharge the electricity of the capacitors. Where checking it by a volt-ohm meter, confirm the polarity beforehand. Do not apply mechanical stress to the terminals of the capacitors during inspection.
- 2) Characteristics to be inspected
 - ① Significant damage in appearance: vent opening, electrolyte leakage, etc.
 - ② Electrical characteristics: leakage current, capacitance, $\tan \delta$ and other characteristics prescribed in the catalogs or product specifications

If finding anything abnormal on the characteristics above, check the specifications of the capacitor and take appropriate actions such as replacement.

5) Capacitor venting

- 1) A capacitor with more than a certain case size has the pressure relief vent functioning to escape abnormal gas pressure increase.
 If gas expels from a venting capacitor, disconnect the power supply of the device or unplug the power supply cord. If not disconnecting the power supply, the device circuit may be damaged due to the short circuit failure of the capacitor or short-circuited with the liquid that the gas was condensed to. It may cause secondary damages such as device burnout in the worst case scenario.
 The gas that comes out of the open vent is vaporized electrolyte, not smoke.
- 2) The gas expelled from a venting capacitor is more than 100°C. Never expose your face to the capacitor. If your eyes are exposed to the gas or you inhale it, immediately flush your eyes and/or gargle with water. If the electrolyte comes in contact with the skin, wash with soap and water.

6) Storage

- 1) Do not store capacitors at high temperature or high humidity. Store the capacitors indoors at temperatures of 5 to 35°C and humidities of less than 75%RH.
 In principle, aluminum electrolytic capacitors should be used within three years after production.
- 2) Keep capacitors packed in the original packaging material wherever possible.

- 3) Avoid the following storage environmental conditions:
- ① Water spattering, high temperatures, high humidity or condensation environment.
 - ② Oil spattering or oil mist filled.
 - ③ Salt water spattering or salt filled.
 - ④ Acidic toxic gases such as hydrogen sulfide, sulfuric acid, nitrous acid, chlorine, bromine and methyl bromide filled.
 - ⑤ Alkaline toxic gases such as ammonium filled.
 - ⑥ Acid or alkaline solutions spattering.
 - ⑦ Direct sunlight, ozone, ultraviolet rays or radiation.
 - ⑧ Extreme vibration or shock loading
- 4) JEDEC J-STD-020 (rev. C) is not applicable.

7 Capacitor disposal

Please consult with a local organization for the proper disposal of industrial waste. For incinerating capacitors, apply a high-temperature incineration (over 800°C). Incinerating them at temperatures lower than that may produce toxic gases such as chlorine. To prevent capacitors from explosion, punch holes in or sufficiently crush the can cases of the capacitors, then incinerate.

8 Catalogs

Specifications in the catalogs are subject to change without notice. Test data shown in the catalogs are not assured as the whole performance values, but typical values.

For more details, refer to JEITA/EIAJ RCR-2367C (March 2006) with the title of "Safety Application Guide for fixed aluminum electrolytic capacitors for use in electronic equipment".

9 Regarding compliance for EU REACH Regulation

- 1) According to the content of REACH handbook (Guidance on requirements for substances in articles which is published on May 2008), our electronic components are "articles without any intended release". Therefore they are not applicable for "Registration" for EU REACH Regulation Article 7 (1).
Reference: Electrolytic Condenser Investigation Society
"Study of REACH Regulation in EU about Electrolytic Capacitor"
(publicized on 13 March 2008)
- 2) Nippon Chemi-Con develops the products without substance of very high concern(SVHC).DEHP(CASNo.117-81-7) was contained as some covering material, Nippon Chemi-Con abolished use of DEHP totally at June, 2011.

Surface Mount Aluminum Electrolytic Capacitors

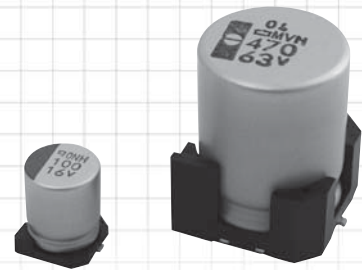

Product code guide (Surface mount type)

(Example : MVA series, 25V-47 μ F, ϕ 6.3 \times 5.2L)



Please refer to the following table

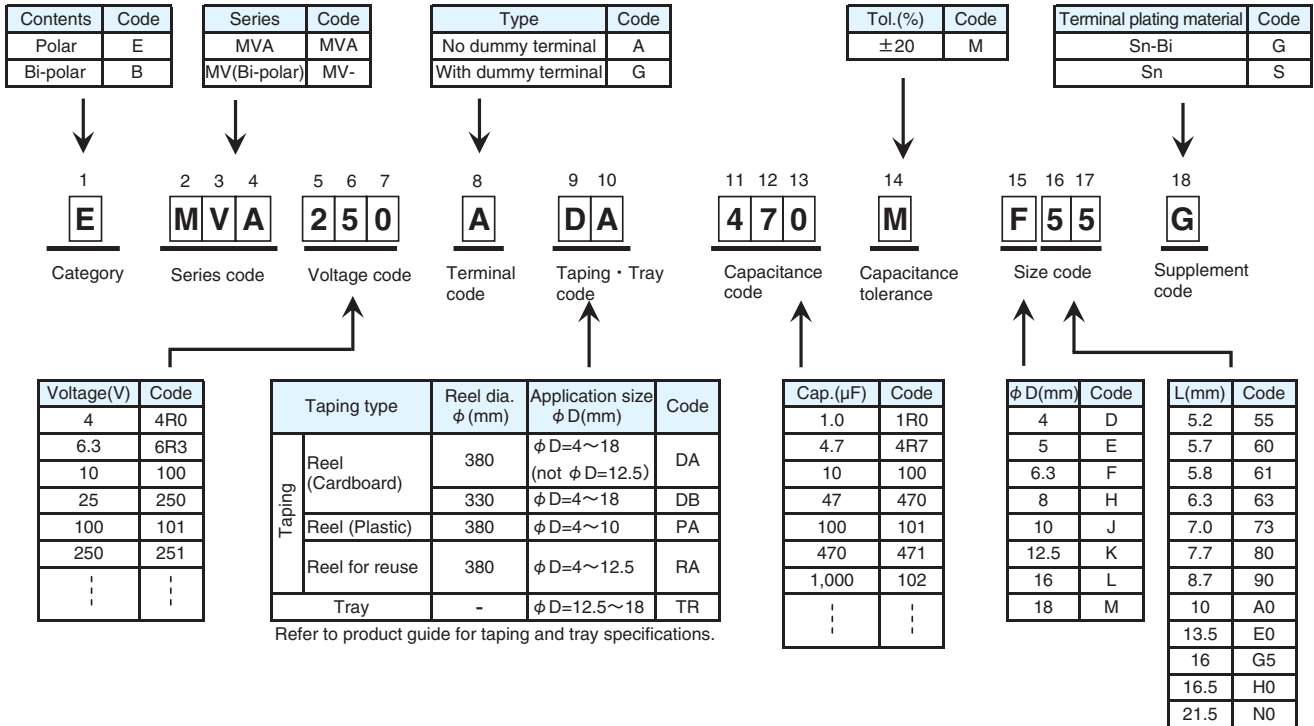

*Refer to the appendix (Part number) for codes not listed here.

Alchip™-MVA Series

- φ4 through φ18 case sizes are fully lined up
- Endurance : 2,000 hours at 85°C
- Suitable to fit for downsized equipment
- Solvent resistant type except 100 to 450V_{dc} (see PRECAUTIONS AND GUIDELINES)
- RoHS Compliant

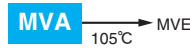

◆ SPECIFICATIONS

Items	Characteristics												
Category Temperature Range	-40 to +85°C												
Rated Voltage Range	4 to 450V _{dc}												
Capacitance Tolerance	±20% (M) (at 20°C, 120Hz)												
Leakage Current	Rated voltage (V _{dc})	4 to 100V						160 to 450V					
	D55 to JA0	I=0.01CV or 3μA, whichever is greater.(after 2 minutes)						—					
	KE0 to MNO	I=0.03CV or 4μA, whichever is greater.(after 1 minute)						I=0.04CV+100μA max.(after 1 minute)					
Where, I : Max. leakage current (μA), C : Nominal capacitance (μF), V : Rated voltage (V) (at 20°C)													
Dissipation Factor (tanδ)	Rated voltage (V _{dc})	4V	6.3V	10V	16V	25V	35V	50V	63V	100V	160 to 250V	400 & 450V	
	tanδ (Max.)	D55 to JA0	0.42	0.35	0.30	0.26	0.16	0.14	0.12	0.12	0.12	—	—
		KE0 to MNO	—	0.38	0.34	0.30	0.26	0.22	0.18	0.14	0.10	0.20	0.25
When nominal capacitance exceeds 1,000μF, add 0.02 to the value above for each 1,000μF increase. (at 20°C, 120Hz)													
Low Temperature Characteristics (Max. Impedance Ratio)	Rated voltage (V _{dc})	4V	6.3V	10V	16V	25V	35V	50V	63V	100V	160 to 250V	400 & 450V	
	D55 to JA0	Z(-25°C)/Z(+20°C)	7	4	3	2	2	2	2	2	3	—	—
		Z(-40°C)/Z(+20°C)	17	10	8	6	4	3	3	3	4	—	—
	KE0 to MNO	Z(-25°C)/Z(+20°C)	—	5	4	3	2	2	2	2	2	3	6
Z(-40°C)/Z(+20°C)		—	12	10	8	5	4	3	3	3	6	10	
Endurance	The following specifications shall be satisfied when the capacitors are restored to 20°C after the rated voltage is applied for 2,000 hours at 85°C.												
	Size code	D55 to JA0			D55 to JA0			KE0 to MNO					
	Rated voltage (V _{dc})	4V & 6.3V			10 to 100V			6.3 to 450V					
	Capacitance change	≤±30% of the initial value			≤±20% of the initial value			≤±20% of the initial value					
	D.F. (tanδ)	≤200% of the initial specified value			≤200% of the initial specified value			≤200% of the initial specified value					
	Leakage current	≤The initial specified value			≤The initial specified value			≤The initial specified value					
Shelf Life	The following specifications shall be satisfied when the capacitors are restored to 20°C after exposing them for 1,000 hours at 85°C without voltage applied. Before the measurement, the capacitor shall be preconditioned by applying voltage according to Item 4.1 of JIS C 5101-4.												
	Size code	D55 to JA0			D55 to JA0			KE0 to MNO					
	Rated voltage	4V & 6.3V			10 to 100V			6.3 to 450V					
	Capacitance change	≤±30% of the initial value			≤±20% of the initial value			≤±20% of the initial value					
	D.F. (tanδ)	≤200% of the initial specified value			≤200% of the initial specified value			≤200% of the initial specified value					
	Leakage current	≤The initial specified value			≤The initial specified value			≤The initial specified value					

◆ DIMENSIONS [mm]

- Terminal Code : A
- Size code : D55 to MNO

- Terminal Code : G
- Size code : LH0 to MNO

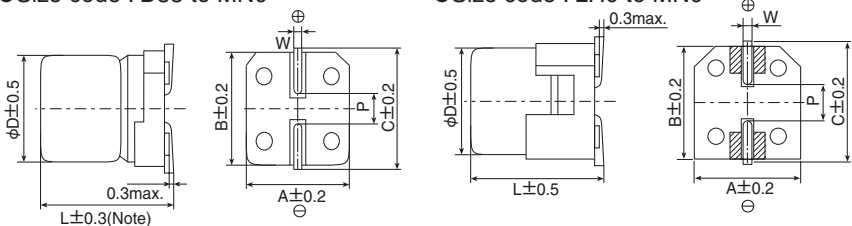

Size code	D	L	A	B	C	W	P
D55	4	5.2	4.3	4.3	5.1	0.5 to 0.8	1.0
E55	5	5.2	5.3	5.3	5.9	0.5 to 0.8	1.4
F55	6.3	5.2	6.6	6.6	7.2	0.5 to 0.8	1.9
F80	6.3	7.7	6.6	6.6	7.2	0.5 to 0.8	1.9
HA0	8	10.0	8.3	8.3	9.0	0.7 to 1.1	3.1
JA0	10	10.0	10.3	10.3	11.0	0.7 to 1.1	4.5
KE0	12.5	13.5	13.0	13.0	13.7	1.0 to 1.3	4.2
KG5	12.5	16.0	13.0	13.0	13.7	1.0 to 1.3	4.2
LH0	16	16.5	17.0	17.0	18.0	1.0 to 1.3	6.5
LN0	16	21.5	17.0	17.0	18.0	1.0 to 1.3	6.5
MH0	18	16.5	19.0	19.0	20.0	1.0 to 1.3	6.5
MNO	18	21.5	19.0	19.0	20.0	1.0 to 1.3	6.5

◆ PART NUMBERING SYSTEM

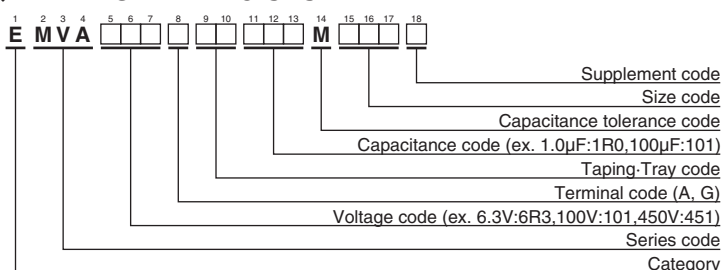

Please refer to "Product code guide (surface mount type)"

◆ MARKING

D55 to JA0

EX) 16V47μF

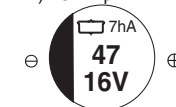

KE0 to HNO

EX) 25V1,000μF

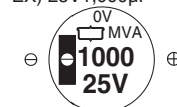

◆ STANDARD RATINGS

is not solvent resistant.

WV (Vdc)	Cap (μF)	Size code	tanδ	Rated ripple current (mA _{rms} /85°C, 120Hz)	Part No.	WV (Vdc)	Cap (μF)	Size code	tanδ	Rated ripple current (mA _{rms} /85°C, 120Hz)	Part No.	
4	33	D55	0.42	25	EMVA4R0ADA330MD55G	35	33	F55	0.14	54	EMVA350ADA330MF55G	
	47	D55	0.42	30	EMVA4R0ADA470MD55G		100	F80	0.14	120	EMVA350ADA101MF80G	
	100	E55	0.42	50	EMVA4R0ADA101ME55G		150	HA0	0.14	210	EMVA350ADA151MHA0G	
	220	F55	0.42	80	EMVA4R0ADA221MF55G		220	HA0	0.14	260	EMVA350ADA221MHA0G	
	330	F80	0.42	135	EMVA4R0ADA331MF80G		330	JA0	0.14	360	EMVA350ADA331MJA0G	
	470	F80	0.42	150	EMVA4R0ADA471MF80G		470	KE0	0.22	600	EMVA350ARA471MKE0S	
6.3	1,000	HA0	0.42	320	EMVA4R0ADA102MHA0G	1,000	LH0	0.22	1,100	EMVA350□DA102MLH0S		
	33	D55	0.35	30	EMVA6R3ADA330MD55G	2,200	MN0	0.24	1,700	EMVA350□DA222MMN0S		
	47	D55	0.35	33	EMVA6R3ADA470MD55G	50	3.3	D55	0.12	15	EMVA500ADA3R3MD55G	
	100	E55	0.35	55	EMVA6R3ADA101ME55G		4.7	D55	0.12	18	EMVA500ADA4R7MD55G	
	220	F55	0.35	88	EMVA6R3ADA221MF55G		10	E55	0.12	30	EMVA500ADA100ME55G	
	330	F80	0.35	135	EMVA6R3ADA331MF80G		22	F55	0.12	47	EMVA500ADA220MF55G	
	470	HA0	0.35	280	EMVA6R3ADA471MHA0G		33	F80	0.12	70	EMVA500ADA330MF80G	
	680	HA0	0.35	290	EMVA6R3ADA681MHA0G		47	F80	0.12	85	EMVA500ADA470MF80G	
	820	HA0	0.35	320	EMVA6R3ADA821MHA0G		100	HA0	0.12	190	EMVA500ADA101MHA0G	
	1,000	JA0	0.35	430	EMVA6R3ADA102MJA0G		220	JA0	0.12	320	EMVA500ADA221MJA0G	
	1,500	JA0	0.35	480	EMVA6R3ADA152MJA0G		330	KE0	0.18	600	EMVA500ARA331MKE0S	
	2,200	KE0	0.40	890	EMVA6R3ARA222MKE0S		470	KG5	0.18	740	EMVA500ARA471MKG5S	
	3,300	KG5	0.42	1,000	EMVA6R3ARA332MKG5S		470	LH0	0.18	850	EMVA500□DA471MLH0S	
	3,300	LH0	0.42	1,200	EMVA6R3□DA332MLH0S		1,000	LNO	0.18	1,300	EMVA500□DA102MLN0S	
4,700	LH0	0.44	1,400	EMVA6R3□DA472MLH0S	1,000		MN0	0.18	1,400	EMVA500□DA102MMN0S		
6,800	LNO	0.48	1,750	EMVA6R3□DA682MLN0S	63	1.0	D55	0.12	8.0	EMVA630ADA1R0MD55G		
6,800	MH0	0.48	1,700	EMVA6R3□DA682MMH0S		2.2	D55	0.12	12	EMVA630ADA2R2MD55G		
10,000	MN0	0.56	2,000	EMVA6R3□DA103MMN0S		3.3	E55	0.12	17	EMVA630ADA3R3ME55G		
10	22	D55	0.30	26		EMVA100ADA220MD55G	4.7	E55	0.12	20	EMVA630ADA4R7ME55G	
	33	D55	0.30	30		EMVA100ADA330MD55G	10	F55	0.12	32	EMVA630ADA100MF55G	
	47	E55	0.30	44		EMVA100ADA470ME55G	22	F80	0.12	60	EMVA630ADA220MF80G	
	100	F55	0.30	70		EMVA100ADA101MF55G	33	HA0	0.12	110	EMVA630ADA330MHA0G	
	150	F55	0.30	79		EMVA100ADA151MF55G	47	HA0	0.12	130	EMVA630ADA470MHA0G	
	220	F80	0.30	130		EMVA100ADA221MF80G	56	JA0	0.12	160	EMVA630ADA560MJA0G	
	330	HA0	0.30	270		EMVA100ADA331MHA0G	68	JA0	0.12	170	EMVA630ADA680MJA0G	
	470	HA0	0.30	280		EMVA100ADA471MHA0G	100	KE0	0.14	380	EMVA630ARA101MKE0S	
	1,000	JA0	0.30	430		EMVA100ADA102MJA0G	220	KE0	0.14	580	EMVA630ARA221MKE0S	
	2,200	KE0	0.36	960		EMVA100ARA222MKE0S	330	KG5	0.14	720	EMVA630ARA331MKG5S	
	3,300	LH0	0.38	1,300	EMVA100□DA332MLH0S	330	LH0	0.14	820	EMVA630□DA331MLH0S		
	4,700	LNO	0.40	1,550	EMVA100□DA472MLN0S	470	LH0	0.14	950	EMVA630□DA471MLH0S		
	4,700	MH0	0.40	1,600	EMVA100□DA472MMH0S	470	MH0	0.14	1,000	EMVA630□DA471MMH0S		
6,800	MN0	0.44	1,850	EMVA100□DA682MMN0S	100	22	HA0	0.12	90	EMVA101ADA220MHA0G		
16	22	D55	0.26	26		EMVA160ADA220MD55G	33	JA0	0.12	120	EMVA101ADA330MJA0G	
	33	E55	0.26	37		EMVA160ADA330ME55G	68	KE0	0.10	380	EMVA101ARA680MKE0S	
	47	E55	0.26	44		EMVA160ADA470ME55G	100	KE0	0.10	440	EMVA101ARA101MKE0S	
	100	F55	0.26	70		EMVA160ADA101MF55G	220	LNO	0.10	850	EMVA101□DA221MLN0S	
	150	F80	0.26	110		EMVA160ADA151MF80G	220	MH0	0.10	800	EMVA101□DA221MMH0S	
	220	F80	0.26	130		EMVA160ADA221MF80G	330	MN0	0.10	1,000	EMVA101□DA331MMN0S	
	330	HA0	0.26	270		EMVA160ADA331MHA0G	160	47	KG5	0.20	370	EMVA161ARA470MKG5S
	470	HA0	0.26	280		EMVA160ADA471MHA0G		68	LH0	0.20	500	EMVA161□DA680MLH0S
	680	JA0	0.26	380		EMVA160ADA681MJA0G		100	LNO	0.20	590	EMVA161□DA101MLN0S
	1,000	KE0	0.30	710		EMVA160ARA102MKE0S	100	MH0	0.20	590	EMVA161□DA101MMH0S	
	2,200	LH0	0.32	1,150		EMVA160□DA222MLH0S	200	22	KE0	0.20	240	EMVA201ARA220MKE0S
	3,300	LNO	0.34	1,450		EMVA160□DA332MLN0S		33	KG5	0.20	310	EMVA201ARA330MKG5S
	3,300	MH0	0.34	1,450	EMVA160□DA332MMH0S	47		LH0	0.20	420	EMVA201□DA470MLH0S	
4,700	MN0	0.36	1,750	EMVA160□DA472MMN0S	68	LNO	0.20	510	EMVA201□DA680MLN0S			
25	10	D55	0.16	24	EMVA250ADA100MD55G	68	MH0	0.20	510	EMVA201□DA680MMH0S		
	22	E55	0.16	41	EMVA250ADA220ME55G	100	MN0	0.20	590	EMVA201□DA101MMN0S		
	33	E55	0.16	47	EMVA250ADA330ME55G	250	10	KE0	0.20	150	EMVA251ARA100MKE0S	
	47	F55	0.16	60	EMVA250ADA470MF55G		22	KG5	0.20	240	EMVA251ARA220MKG5S	
	56	F55	0.16	66	EMVA250ADA560MF55G		33	LH0	0.20	340	EMVA251□DA330MLH0S	
	100	F80	0.16	120	EMVA250ADA101MF80G	47	LNO	0.20	420	EMVA251□DA470MLN0S		
	150	HA0	0.16	210	EMVA250ADA151MHA0G	47	MH0	0.20	420	EMVA251□DA470MMH0S		
	220	HA0	0.16	260	EMVA250ADA221MHA0G	68	MN0	0.20	490	EMVA251□DA680MMN0S		
	330	HA0	0.16	300	EMVA250ADA331MHA0G	400	4.7	KE0	0.25	120	EMVA401ARA4R7MKE0S	
	470	JA0	0.16	400	EMVA250ADA471MJA0G		10	LH0	0.25	140	EMVA401□DA100MLH0S	
	1,000	KE0	0.26	820	EMVA250ARA102MKE0S		22	LNO	0.25	280	EMVA401□DA220MLN0S	
	2,200	LNO	0.28	1,450	EMVA250□DA222MLN0S	22	MH0	0.25	280	EMVA401□DA220MMH0S		
	2,200	MH0	0.28	1,400	EMVA250□DA222MMH0S	33	MN0	0.25	350	EMVA401□DA330MMN0S		
3,300	MN0	0.30	1,800	EMVA250□DA332MMN0S	450	4.7	KE0	0.25	120	EMVA451ARA4R7MKE0S		
35	4.7	D55	0.14	18		EMVA350ADA4R7MD55G	10	LH0	0.25	140	EMVA451□DA100MLH0S	
	10	D55	0.14	24		EMVA350ADA100MD55G	22	LNO	0.25	280	EMVA451□DA220MLN0S	
	22	E55	0.14	41	EMVA350ADA220ME55G	33	MN0	0.25	350	EMVA451□DA330MMN0S		

□ : Enter the appropriate terminal code.

Alchip™-MVE Series

- Rated voltage range : 6.3 to 450V, capacitance range : 1.0 to 6,800μF
- Endurance : 1,000 to 2,000 hours at 105°C
- Case size range : φ4×5.2L to φ18×21.5L
- Solvent resistant type except 100 to 450V_{dc} (see PRECAUTIONS AND GUIDELINES)
- RoHS Compliant

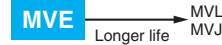

◆ SPECIFICATIONS

Items	Characteristics		
Category	-40 to +105°C		
Temperature Range	-40 to +105°C		
Rated Voltage Range	6.3 to 450V _{dc}		
Capacitance Tolerance	±20%(M) (20°C, 120Hz)		
Leakage Current	Rated voltage (V _{dc})	6.3 to 100V	
	D55 to JA0	I=0.01CV or 3μA, whichever is greater (2 minutes)	
	KE0 to MN0	I=0.03CV or 4μA, whichever is greater (1 minute)	
		I=0.04CV+100μA (1minute)	
	Where, I : Max. leakage current (μA), C : Nominal capacitance (μF), V : Rated voltage (V) (20°C)		
Dissipation Factor (tanδ)	See STANDARD RATINGS (20°C, 120Hz)		
Low Temperature Characteristics (Max. Impedance Ratio)	Rated voltage (V _{dc})	6.3V 10V 16V 25V 35V 50V 63V 100V 160 to 250V 400 to 450V	
	D55 to JA0	Z(-25°C)/Z(+20°C)	4 3 2 2 2 2 2 3 4 — —
		Z(-40°C)/Z(+20°C)	12 8 6 4 3 3 3 4 — —
	KE0 to MN0	Z(-25°C)/Z(+20°C)	5 4 3 2 2 2 2 2 3 6
Z(-40°C)/Z(+20°C)		10 8 6 4 3 3 3 3 6 10	
	(120Hz)		
Endurance	The following specifications shall be satisfied when the capacitors are restored to 20°C after the rated voltage is applied for the specified period of time at 105°C.		
	Size code	D55 to F80	
	Time	1,000 hours	
	Capacitance change	≤ ±30% of the initial value	
	D.F. (tanδ)	≤300% of the initial specified value	
	Leakage current	≤The initial specified value	
Shelf Life	The following specifications shall be satisfied when the capacitors are restored to 20°C after exposing them for 1,000 hours (500 hours for B55 to F80 size) at 105°C without voltage applied. Before the measurement, the capacitor shall be preconditioned by applying voltage according to Item 4.1 of JIS C 5101-4.		
	Size code	D55 to F80	
	Capacitance change	≤ ±25% of the initial value	
	D.F. (tanδ)	≤200% of the initial specified value	
	Leakage current	≤The initial specified value	
		HA0 to MN0	
	2,000 hours		
	≤ ±20% of the initial value		
	≤200% of the initial specified value		
	≤The initial specified value		

◆ DIMENSIONS [mm]

- Terminal Code : A
- Size code : D55 to MN0

- Terminal Code : G
- Size code : LH0 to MN0

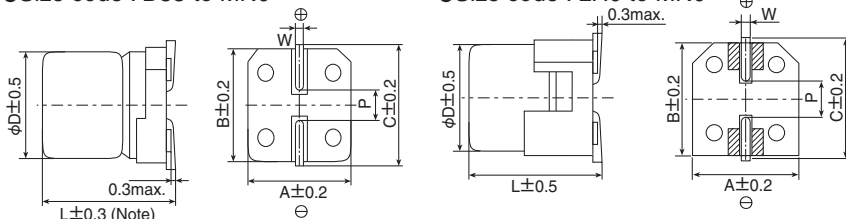

Note : L±0.5 for HA0 to MN0

▨ : Dummy terminals

Size code	D	L	A	B	C	W	P
D55	4	5.2	4.3	4.3	5.1	0.5 to 0.8	1.0
E55	5	5.2	5.3	5.3	5.9	0.5 to 0.8	1.4
F55	6.3	5.2	6.6	6.6	7.2	0.5 to 0.8	1.9
F80	6.3	7.7	6.6	6.6	7.2	0.5 to 0.8	1.9
HA0	8	10.0	8.3	8.3	9.0	0.7 to 1.1	3.1
JA0	10	10.0	10.3	10.3	11.0	0.7 to 1.1	4.5
KE0	12.5	13.5	13.0	13.0	13.7	1.0 to 1.3	4.2
KG5	12.5	16.0	13.0	13.0	13.7	1.0 to 1.3	4.2
LH0	16	16.5	17.0	17.0	18.0	1.0 to 1.3	6.5
LN0	16	21.5	17.0	17.0	18.0	1.0 to 1.3	6.5
MH0	18	16.5	19.0	19.0	20.0	1.0 to 1.3	6.5
MN0	18	21.5	19.0	19.0	20.0	1.0 to 1.3	6.5

◆ PART NUMBERING SYSTEM

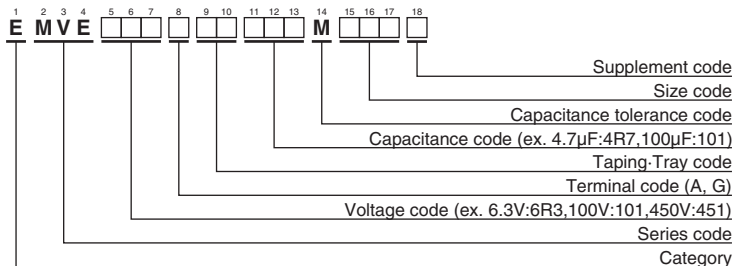

Please refer to "Product code guide (surface mount type)"

◆ MARKING

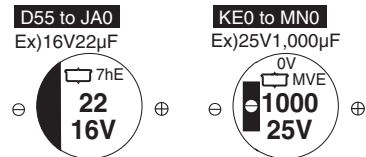

◆ STANDARD RATINGS

□ is not solvent resistant.

WV (V _{dc})	Cap (μF)	Size code	tanδ	Rated ripple current (mA _{rms} /105°C, 120Hz)	Part No.	WV (V _{dc})	Cap (μF)	Size code	tanδ	Rated ripple current (mA _{rms} /105°C, 120Hz)	Part No.		
6.3	22	D55	0.30	22	EMVE6R3ADA220MD55G	35	330	JA0	0.16	450	EMVE350ADA331MJA0G		
	33	E55	0.30	34	EMVE6R3ADA330ME55G		470	KE0	0.22	520	EMVE350ARA471MKE0S		
	47	E55	0.30	38	EMVE6R3ADA470ME55G		470	LH0	0.22	650	EMVE350□DA471MLH0S		
	100	F55	0.30	69	EMVE6R3ADA101MF55G		1,000	LH0	0.22	750	EMVE350□DA102MLH0S		
	220	F80	0.45	120	EMVE6R3ADA221MF80G		1,000	MH0	0.22	1,000	EMVE350□DA102MMH0S		
	330	HA0	0.40	290	EMVE6R3ADA331MHA0G		2,200	MN0	0.24	1,450	EMVE350□DA222MMN0S		
	470	HA0	0.45	320	EMVE6R3ADA471MHA0G		50	1.0	D55	0.12	8.0	EMVE500ADA1R0MD55G	
	680	HA0	0.45	340	EMVE6R3ADA681MHA0G			2.2	D55	0.12	12	EMVE500ADA2R2MD55G	
	1,000	JA0	0.40	410	EMVE6R3ADA102MJA0G			3.3	D55	0.12	15	EMVE500ADA3R3MD55G	
	1,500	JA0	0.45	550	EMVE6R3ADA152MJA0G			4.7	E55	0.12	20	EMVE500ADA4R7ME55G	
	2,200	KE0	0.40	680	EMVE6R3ARA222MKE0S			10	F55	0.12	32	EMVE500ADA100MF55G	
	2,200	LH0	0.40	840	EMVE6R3□DA222MLH0S			33	F80	0.14	65	EMVE500ADA330MF80G	
	3,300	KG5	0.42	850	EMVE6R3ARA332MKG5S			47	F80	0.14	80	EMVE500ADA470MF80G	
	3,300	MH0	0.42	1,000	EMVE6R3□DA332MMH0S			100	HA0	0.14	230	EMVE500ADA101MHA0G	
	4,700	LNO	0.44	1,200	EMVE6R3□DA472MLN0S			220	JA0	0.14	375	EMVE500ADA221MJA0G	
	4,700	MH0	0.44	1,200	EMVE6R3□DA472MMH0S			330	KE0	0.18	500	EMVE500ARA331MKE0S	
6,800	LNO	0.48	1,200	EMVE6R3□DA682MLN0S	330	LH0		0.18	600	EMVE500□DA331MLH0S			
6,800	MN0	0.48	1,350	EMVE6R3□DA682MMN0S	470	LH0		0.18	700	EMVE500□DA471MLH0S			
					470	MH0		0.18	750	EMVE500□DA471MMH0S			
					1,000	MN0		0.18	1,200	EMVE500□DA102MMN0S			
10	22	E55	0.24	30	EMVE100ADA220ME55G	63		1.0	D55	0.12	8.0	EMVE630ADA1R0MD55G	
	33	E55	0.24	34	EMVE100ADA330ME55G			2.2	D55	0.12	12	EMVE630ADA2R2MD55G	
	47	F55	0.24	48	EMVE100ADA470MF55G		3.3	E55	0.12	17	EMVE630ADA3R3ME55G		
	100	F55	0.30	69	EMVE100ADA101MF55G		4.7	F55	0.12	22	EMVE630ADA4R7MF55G		
	150	F80	0.35	100	EMVE100ADA151MF80G		10	F55	0.12	32	EMVE630ADA100MF55G		
	220	F80	0.35	120	EMVE100ADA221MF80G		22	F80	0.12	58	EMVE630ADA220MF80G		
	330	HA0	0.35	290	EMVE100ADA331MHA0G		33	HA0	0.12	140	EMVE630ADA330MHA0G		
	470	HA0	0.35	320	EMVE100ADA471MHA0G		47	HA0	0.12	170	EMVE630ADA470MHA0G		
	1,000	JA0	0.35	410	EMVE100ADA102MJA0G		100	JA0	0.12	310	EMVE630ADA101MJA0G		
	2,200	KG5	0.36	750	EMVE100ARA222MKG5S		220	KE0	0.14	470	EMVE630ARA221MKE0S		
	2,200	LH0	0.36	850	EMVE100□DA222MLH0S		220	LH0	0.14	560	EMVE630□DA221MLH0S		
	3,300	LH0	0.38	1,000	EMVE100□DA332MLH0S		330	LH0	0.14	700	EMVE630□DA331MLH0S		
	3,300	MH0	0.38	1,100	EMVE100□DA332MMH0S		330	MH0	0.14	750	EMVE630□DA331MMH0S		
	4,700	LNO	0.40	1,300	EMVE100□DA472MLN0S		470	LNO	0.14	900	EMVE630□DA471MLN0S		
	4,700	MN0	0.40	1,350	EMVE100□DA472MMN0S		470	MH0	0.14	900	EMVE630□DA471MMH0S		
	16	10	D55	0.20	17		EMVE160ADA100MD55G	100	22	HA0	0.12	100	EMVE101ADA220MHA0G
22		E55	0.20	30	EMVE160ADA220ME55G	33	JA0		0.12	150	EMVE101ADA330MJA0G		
33		F55	0.20	45	EMVE160ADA330MF55G	47	KE0		0.10	250	EMVE101ARA470MKE0S		
47		F55	0.20	48	EMVE160ADA470MF55G	68	KE0		0.10	300	EMVE101ARA680MKE0S		
100		F55	0.26	69	EMVE160ADA101MF55G	100	KE0		0.10	380	EMVE101ARA101MKE0S		
150		F80	0.28	100	EMVE160ADA151MF80G	100	LH0		0.10	450	EMVE101□DA101MLH0S		
220		F80	0.28	120	EMVE160ADA221MF80G	220	LNO		0.10	750	EMVE101□DA221MLN0S		
330		HA0	0.28	290	EMVE160ADA331MHA0G	220	MH0		0.10	750	EMVE101□DA221MMH0S		
470		HA0	0.28	320	EMVE160ADA471MHA0G	330	MN0		0.10	980	EMVE101□DA331MMN0S		
680		JA0	0.28	470	EMVE160ADA681MJA0G	33	KE0		0.15	95	EMVE161ARA330MKE0S		
1,000		KE0	0.30	550	EMVE160ARA102MKE0S	47	LH0		0.15	260	EMVE161□DA470MLH0S		
1,000		LH0	0.30	650	EMVE160□DA102MLH0S	68	LNO		0.15	320	EMVE161□DA680MLN0S		
2,200		LH0	0.32	950	EMVE160□DA222MLH0S	68	MH0		0.15	320	EMVE161□DA680MMH0S		
2,200		MH0	0.32	1,000	EMVE160□DA222MMH0S	100	LNO		0.15	380	EMVE161□DA101MLN0S		
3,300		LNO	0.34	1,200	EMVE160□DA332MLN0S	100	LNO		0.15	380	EMVE161□DA101MLN0S		
3,300		MH0	0.34	1,200	EMVE160□DA332MMH0S	10	KE0		0.15	80	EMVE201ARA100MKE0S		
25	10	E55	0.16	27	EMVE250ADA100ME55G	200	22	KG5	0.15	110	EMVE201ARA220MKG5S		
	22	F55	0.16	44	EMVE250ADA220MF55G		33	LH0	0.15	220	EMVE201□DA330MLH0S		
	33	F55	0.16	50	EMVE250ADA330MF55G		47	LNO	0.15	270	EMVE201□DA470MLN0S		
	47	F55	0.16	60	EMVE250ADA470MF55G		47	MH0	0.15	270	EMVE201□DA470MMH0S		
	100	F80	0.18	100	EMVE250ADA101MF80G		68	MN0	0.15	330	EMVE201□DA680MMN0S		
	150	HA0	0.18	240	EMVE250ADA151MHA0G		250	4.7	KE0	0.15	65	EMVE251ARA4R7MKE0S	
	220	HA0	0.18	320	EMVE250ADA221MHA0G			10	KG5	0.15	105	EMVE251ARA100MKG5S	
	330	JA0	0.16	450	EMVE250ADA331MJA0G			22	LH0	0.15	180	EMVE251□DA220MLH0S	
	470	JA0	0.18	490	EMVE250ADA471MJA0G	33		LNO	0.15	230	EMVE251□DA330MLN0S		
	1,000	LH0	0.26	820	EMVE250□DA102MLH0S	33		MH0	0.15	230	EMVE251□DA330MMH0S		
	1,000	MH0	0.26	880	EMVE250□DA102MMH0S	47		MN0	0.15	280	EMVE251□DA470MMN0S		
	2,200	LNO	0.28	1,250	EMVE250□DA222MLN0S	400		4.7	KG5	0.20	50	EMVE401ARA4R7MKG5S	
	2,200	MN0	0.28	1,300	EMVE250□DA222MMN0S			10	LH0	0.20	85	EMVE401□DA100MLH0S	
							22	MN0	0.20	130	EMVE401□DA220MMN0S		
	35	4.7	D55	0.14	16		EMVE350ADA4R7MD55G	450	3.3	KE0	0.20	40	EMVE451ARA3R3MKE0S
		10	E55	0.14	27		EMVE350ADA100ME55G		4.7	KG5	0.20	50	EMVE451ARA4R7MKG5S
22		F55	0.14	44	EMVE350ADA220MF55G		10		LH0	0.20	85	EMVE451□DA100MLH0S	
47		F80	0.16	80	EMVE350ADA470MF80G		22		MN0	0.20	130	EMVE451□DA220MMN0S	
100		F80	0.16	100	EMVE350ADA101MF80G								
150		HA0	0.16	260	EMVE350ADA151MHA0G								
220	JA0	0.16	375	EMVE350ADA221MJA0G									

□ : Enter the appropriate terminal code.

Alchip™-MZJ Series

- Lower ESR, 2,000 hours at 105°C
- Rated voltage range : 6.3 to 35V
- Nominal capacitance range : 10 to 1,800µF
- Solvent resistant type (see PRECAUTIONS AND GUIDELINES)
- RoHS Compliant

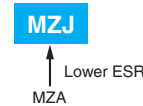

◆ SPECIFICATIONS

Items	Characteristics							
Category	-55 to +105°C							
Temperature Range	-55 to +105°C							
Rated Voltage Range	6.3 to 35V _{dc}							
Capacitance Tolerance	±20% (M) (at 20°C, 120Hz)							
Leakage Current	I=0.01CV or 3µA, whichever is greater. Where, I : Max. leakage current (µA), C : Nominal capacitance (µF), V : Rated voltage (V) (at 20°C after 2 minutes)							
Dissipation Factor (tanδ)	Rated voltage (V _{dc})	6.3V	10V	16V	25V	35V		
	tanδ(Max.)	0.26	0.19	0.16	0.14	0.12	(at 20°C, 120Hz)	
Low Temperature Characteristics (Max. Impedance Ratio)	Rated voltage (V _{dc})	6.3V	10V	16V	25V	35V		
	Z(-25°C)/Z(+20°C)	2	2	2	2	2		
	Z(-40°C)/Z(+20°C)	3	3	3	3	3		
	Z(-55°C)/Z(+20°C)	4	4	4	3	3	(at 120Hz)	
Endurance	The following specifications shall be satisfied when the capacitors are restored to 20°C after the rated voltage is applied for 2,000 hours at 105°C.							
	Capacitance change	≤ ±30% of the initial value						
	D.F. (tanδ)	≤ 200% of the initial specified value						
	Leakage current	≤ The initial specified value						
Shelf Life	The following specifications shall be satisfied when the capacitors are restored to 20°C after exposing them for 1,000 hours at 105°C without voltage applied. Before the measurement, the capacitor shall be preconditioned by applying voltage according to Item 4.1 of JIS C 5101-4.							
	Capacitance change	≤ ±30% of the initial value						
	D.F. (tanδ)	≤ 200% of the initial specified value						
	Leakage current	≤ The initial specified value						
Surge Voltage Test	The capacitors shall be subjected to 1,000 cycles each consisting of charging with the specified surge voltage for 30±5 seconds through a protective resistor (as required for RC=0.1±0.05sec) and open-circuiting for 5.5 minutes at a room temperature of 15 to 35°C.							
	Rated voltage (V _{dc})	6.3V	10V	16V	25V	35V		
	Surge voltage (V _{dc})	7.2V	12V	18V	29V	40V		
	Appearance	No significant damage						
	Capacitance change	≤ ±20% of the initial value						
	D.F. (tanδ)	≤ 200% of the initial specified value						
	Leakage current	≤ The initial specified value						
	(Caution)	Surge Voltage Test intends to evaluate capacitors in durability of an exceptional excessive voltage under specific conditions. It does not imply long-term use at all.						

◆ DIMENSIONS [mm]

● Terminal Code : A

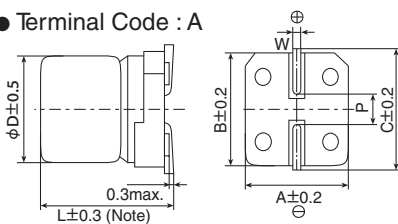

Note : L±0.5 for HA0 and JA0

Size code	D	L	A	B	C	W	P
D61	4	5.8	4.3	4.3	5.1	0.5 to 0.8	1.0
E61	5	5.8	5.3	5.3	5.9	0.5 to 0.8	1.4
F61	6.3	5.8	6.6	6.6	7.2	0.5 to 0.8	1.9
F80	6.3	7.7	6.6	6.6	7.2	0.5 to 0.8	1.9
HA0	8	10.0	8.3	8.3	9.0	0.7 to 1.1	3.1
JA0	10	10.0	10.3	10.3	11.0	0.7 to 1.1	4.5

◆ MARKING

EX) 35V10µF



● Rated voltage symbol

Rated voltage (V _{dc})	Symbol
6.3	j
10	A
16	C
25	E
35	V

◆ PART NUMBERING SYSTEM

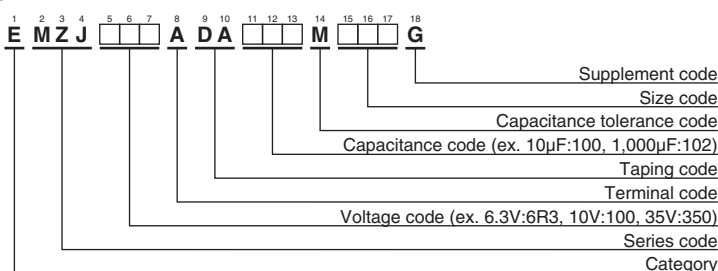

Please refer to "Product code guide (surface mount type)"

Applying voltage over the rated voltages causes the capacitors to have short lifetime. Besides, applying voltage over the specified surge voltages may cause to have short circuit failure. A protection circuit should be used if applied voltage will exceed the rated voltages.



◆ **STANDARD RATINGS**

WV(Vdc)	Cap(μF)	Size code	tan δ	ESR (Ω max/20°C, 100kHz)	Rated ripple current (mA rms/105°C, 100kHz)	Part No.
6.3	47	D61	0.26	0.85	160	EMZJ6R3ADA470MD61G
	100	E61	0.26	0.36	240	EMZJ6R3ADA101ME61G
	220	F61	0.26	0.26	300	EMZJ6R3ADA221MF61G
	330	F80	0.26	0.16	600	EMZJ6R3ADA331MF80G
	1,000	HA0	0.26	0.08	850	EMZJ6R3ADA102MHA0G
	1,500	JA0	0.26	0.06	1,190	EMZJ6R3ADA152MJA0G
	1,800	JA0	0.26	0.06	1,190	EMZJ6R3ADA182MJA0G
10	33	D61	0.19	0.85	160	EMZJ100ADA330MD61G
	150	F61	0.19	0.26	300	EMZJ100ADA151MF61G
	680	HA0	0.19	0.08	850	EMZJ100ADA681MHA0G
	1,000	JA0	0.19	0.06	1,190	EMZJ100ADA102MJA0G
	1,200	JA0	0.19	0.06	1,190	EMZJ100ADA122MJA0G
16	22	D61	0.16	0.85	160	EMZJ160ADA220MD61G
	47	E61	0.16	0.36	240	EMZJ160ADA470ME61G
	100	F61	0.16	0.26	300	EMZJ160ADA101MF61G
	150	F80	0.16	0.16	600	EMZJ160ADA151MF80G
	220	F80	0.16	0.16	600	EMZJ160ADA221MF80G
	470	HA0	0.16	0.08	850	EMZJ160ADA471MHA0G
	680	JA0	0.16	0.06	1,190	EMZJ160ADA681MJA0G
	820	JA0	0.16	0.06	1,190	EMZJ160ADA821MJA0G
25	10	D61	0.14	0.85	160	EMZJ250ADA100MD61G
	22	E61	0.14	0.36	240	EMZJ250ADA220ME61G
	33	E61	0.14	0.36	240	EMZJ250ADA330ME61G
	33	F61	0.14	0.26	300	EMZJ250ADA330MF61G
	47	F61	0.14	0.26	300	EMZJ250ADA470MF61G
	68	F61	0.14	0.26	300	EMZJ250ADA680MF61G
	100	F80	0.14	0.16	600	EMZJ250ADA101MF80G
	330	HA0	0.14	0.08	850	EMZJ250ADA331MHA0G
	470	JA0	0.14	0.06	1,190	EMZJ250ADA471MJA0G
	560	JA0	0.14	0.06	1,190	EMZJ250ADA561MJA0G
35	10	D61	0.12	0.85	160	EMZJ350ADA100MD61G
	22	E61	0.12	0.36	240	EMZJ350ADA220ME61G
	33	F61	0.12	0.26	300	EMZJ350ADA330MF61G
	47	F61	0.12	0.26	300	EMZJ350ADA470MF61G
	68	F61	0.12	0.26	300	EMZJ350ADA680MF61G
	100	F80	0.12	0.16	600	EMZJ350ADA101MF80G
	100	HA0	0.12	0.08	850	EMZJ350ADA101MHA0G
	150	HA0	0.12	0.08	850	EMZJ350ADA151MHA0G
	220	HA0	0.12	0.08	850	EMZJ350ADA221MHA0G
	330	JA0	0.12	0.06	1,190	EMZJ350ADA331MJA0G
	390	JA0	0.12	0.06	1,190	EMZJ350ADA391MJA0G



Alchip™-MZA Series

- Lowest impedance, 2,000 hours at 105°C
- Solvent resistant type (see PRECAUTIONS AND GUIDELINES)
- RoHS Compliant

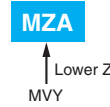

◆ SPECIFICATIONS

Items	Characteristics									
Category	-55 to +105°C									
Temperature Range	-55 to +105°C									
Rated Voltage Range	6.3 to 80V _{dc}									
Capacitance Tolerance	±20%(M) (20°C, 120Hz)									
Leakage Current	I=0.01CV or 3μA, whichever is greater Where, I : Max. leakage current (μA), C : Nominal capacitance (μF), V : Rated voltage (V) (at 20°C after 2 minutes)									
Dissipation Factor (tanδ)	Rated voltage(V _{dc})	6.3V	10V	16V	25V	35V	50V	63V	80V	
	tanδ(Max.)	0.26	0.19	0.16	0.14	0.12	0.10	0.08	0.08	(20°C, 120Hz)
Low Temperature Characteristics (Max. impedance Ratio)	Rated voltage(V _{dc})	6.3V	10V	16V	25V	35V	50V	63V	80V	
	Z(-25°C)/Z(+20°C)	2	2	2	2	2	2	2	2	
	Z(-40°C)/Z(+20°C)	3	3	3	3	3	3	3	3	(120Hz)
	Z(-55°C)/Z(+20°C)	4	4	4	3	3	3	3	3	
Endurance	The following specifications shall be satisfied when the capacitors are restored to 20°C after the rated voltage is applied for 2,000 hours at 105°C.									
	Capacitance change	≤ ±30% of the initial value								
	D.F. (tanδ)	≤200% of the initial specified value								
	Leakage current	≤The initial specified value								

◆ DIMENSIONS [mm]

- Terminal Code : A

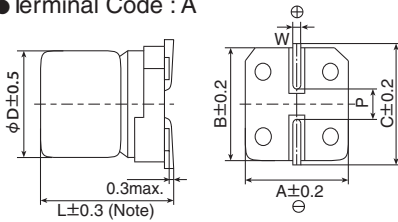

Note : L±0.5 for HA0 and JA0

Size code	D	L	A	B	C	W	P
D61	4	5.8	4.3	4.3	5.1	0.5 to 0.8	1.0
E61	5	5.8	5.3	5.3	5.9	0.5 to 0.8	1.4
F61	6.3	5.8	6.6	6.6	7.2	0.5 to 0.8	1.9
F80	6.3	7.7	6.6	6.6	7.2	0.5 to 0.8	1.9
HA0	8	10.0	8.3	8.3	9.0	0.7 to 1.1	3.1
JA0	10	10.0	10.3	10.3	11.0	0.7 to 1.1	4.5

◆ MARKING

EX) 16V220μF



- Rated voltage symbol

Rated voltage (V _{dc})	Symbol
6.3	j
10	A
16	C
25	E
35	V
50	H
63	J
80	K

◆ PART NUMBERING SYSTEM

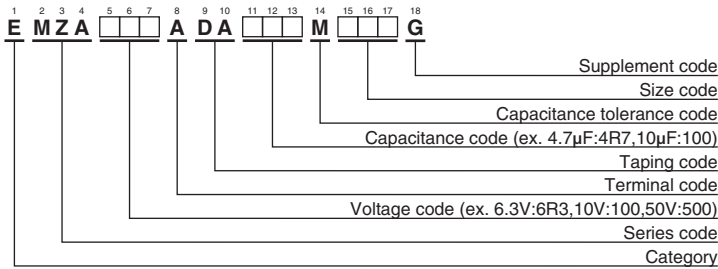

Please refer to "Product code guide (surface mount type)"

◆ STANDARD RATINGS

WV(Vdc)	Cap(μF)	Size code	tanδ	Impedance (Ω max/20°C, 100kHz)	Rated ripple current (mA rms/105°C, 100kHz)	Part No.
6.3	22	D61	0.26	1.35	90	EMZA6R3ADA220MD61G
	47	D61	0.26	1.35	90	EMZA6R3ADA470MD61G
	47	E61	0.26	0.70	160	EMZA6R3ADA470ME61G
	100	E61	0.26	0.70	160	EMZA6R3ADA101ME61G
	100	F61	0.26	0.36	240	EMZA6R3ADA101MF61G
	220	F61	0.26	0.36	240	EMZA6R3ADA221MF61G
	330	F80	0.26	0.34	280	EMZA6R3ADA331MF80G
	470	HA0	0.26	0.16	600	EMZA6R3ADA471MHA0G
	1,000	HA0	0.26	0.16	600	EMZA6R3ADA102MHA0G
1,500	JA0	0.26	0.08	850	EMZA6R3ADA152MJA0G	
10	22	D61	0.19	1.35	90	EMZA100ADA220MD61G
	33	D61	0.19	1.35	90	EMZA100ADA330MD61G
	33	E61	0.19	0.70	160	EMZA100ADA330ME61G
	220	F80	0.19	0.34	280	EMZA100ADA221MF80G
	330	HA0	0.19	0.16	600	EMZA100ADA331MHA0G
	470	HA0	0.19	0.16	600	EMZA100ADA471MHA0G
	680	HA0	0.19	0.16	600	EMZA100ADA681MHA0G
	1,000	JA0	0.19	0.08	850	EMZA100ADA102MJA0G
	16	10	D61	0.16	1.35	90
22		D61	0.16	1.35	90	EMZA160ADA220MD61G
22		E61	0.16	0.70	160	EMZA160ADA220ME61G
47		E61	0.16	0.70	160	EMZA160ADA470ME61G
47		F61	0.16	0.36	240	EMZA160ADA470MF61G
100		F61	0.16	0.36	240	EMZA160ADA101MF61G
220		F80	0.16	0.34	280	EMZA160ADA221MF80G
330		HA0	0.16	0.16	600	EMZA160ADA331MHA0G
470		HA0	0.16	0.16	600	EMZA160ADA471MHA0G
680	JA0	0.16	0.08	850	EMZA160ADA681MJA0G	
25	10	D61	0.14	1.35	90	EMZA250ADA100MD61G
	22	E61	0.14	0.70	160	EMZA250ADA220ME61G
	33	E61	0.14	0.70	160	EMZA250ADA330ME61G
	33	F61	0.14	0.36	240	EMZA250ADA330MF61G
	47	F61	0.14	0.36	240	EMZA250ADA470MF61G
	100	F80	0.14	0.34	280	EMZA250ADA101MF80G
	220	HA0	0.14	0.16	600	EMZA250ADA221MHA0G
	330	HA0	0.14	0.16	600	EMZA250ADA331MHA0G
	470	JA0	0.14	0.08	850	EMZA250ADA471MJA0G
35	4.7	D61	0.12	1.35	90	EMZA350ADA4R7MD61G
	10	D61	0.12	1.35	90	EMZA350ADA100MD61G
	10	E61	0.12	0.70	160	EMZA350ADA100ME61G
	22	E61	0.12	0.70	160	EMZA350ADA220ME61G
	33	F61	0.12	0.36	240	EMZA350ADA330MF61G
	47	F61	0.12	0.36	240	EMZA350ADA470MF61G
	100	F80	0.12	0.34	280	EMZA350ADA101MF80G
	100	HA0	0.12	0.16	600	EMZA350ADA101MHA0G
	220	HA0	0.12	0.16	600	EMZA350ADA221MHA0G
330	JA0	0.12	0.08	850	EMZA350ADA331MJA0G	
50	4.7	D61	0.10	2.90	60	EMZA500ADA4R7MD61G
	10	E61	0.10	1.52	85	EMZA500ADA100ME61G
	10	F61	0.10	0.88	165	EMZA500ADA100MF61G
	22	F61	0.10	0.88	165	EMZA500ADA220MF61G
	33	F80	0.10	0.68	195	EMZA500ADA330MF80G
	47	F80	0.10	0.68	195	EMZA500ADA470MF80G
	100	HA0	0.10	0.34	350	EMZA500ADA101MHA0G
	220	JA0	0.10	0.18	670	EMZA500ADA221MJA0G
63	4.7	E61	0.08	4.8	50	EMZA630ADA4R7ME61G
	10	F61	0.08	2.2	80	EMZA630ADA100MF61G
	22	F80	0.08	2.1	120	EMZA630ADA220MF80G
	33	HA0	0.08	0.70	250	EMZA630ADA330MHA0G
	47	HA0	0.08	0.70	250	EMZA630ADA470MHA0G
	68	HA0	0.08	0.70	250	EMZA630ADA680MHA0G
	100	JA0	0.08	0.45	400	EMZA630ADA101MJA0G
80	3.3	E61	0.08	5.0	25	EMZA800ADA3R3ME61G
	4.7	F61	0.08	3.0	40	EMZA800ADA4R7MF61G
	10	F80	0.08	2.4	60	EMZA800ADA100MF80G
	22	HA0	0.08	1.3	130	EMZA800ADA220MHA0G
	33	HA0	0.08	1.3	130	EMZA800ADA330MHA0G
	47	JA0	0.08	0.70	200	EMZA800ADA470MJA0G

Alchip™-MVY Series

- Endurance : 1,000 to 5,000 hours at 105°C
- Low impedance
- For digital equipment, especially DC-DC converters
- Solvent resistant type except 80 & 100V_{dc} (see PRECAUTIONS AND GUIDELINES)
- RoHS Compliant

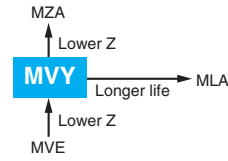

◆ SPECIFICATIONS

Items	Characteristics											
Category Temperature Range	-55 to +105°C (6.3 to 63V _{dc}) -40 to +105°C (80 & 100V _{dc})											
Rated Voltage Range	6.3 to 100V _{dc}											
Capacitance Tolerance	±20% (M) (at 20°C, 120Hz)											
Leakage Current	I=0.01CV or 3μA, whichever is greater. Where, I : Max. leakage current (μA), C : Nominal capacitance (μF), V : Rated voltage (V) (at 20°C after 2 minutes)											
Dissipation Factor (tanδ)	Rated voltage (V _{dc})	6.3V	10V	16V	25V	35V	50V	63V	80V	100V	When nominal capacitance exceeds 1,000μF, add 0.02 to the value above for each 1,000μF increase. (at 20°C, 120Hz)	
	tanδ (Max.)	D55 to F80	0.24	0.20	0.16	0.14	0.12	0.12	—	—		—
		HA0 & JA0	0.28	0.24	0.20	0.16	0.14	0.12	—	—		—
Low Temperature Characteristics (Max. Impedance Ratio)	Rated voltage (V _{dc})	6.3V	10V	16V	25V	35V	50V	63V	80V	100V	(at 120Hz)	
	Z(-40°C)/Z(+20°C)	D55 to JA0	3	2	2	2	2	2	—	—		—
		KE0 to MN0	10	8	6	4	3	3	3	3		3
Endurance	The following specifications shall be satisfied when the capacitors are restored to 20°C after the rated voltage is applied for specified time at 105°C.											
	Time	D55 to F80 : 1,000 hours HA0 & JA0 : 2,000 hours KE0 to MN0 : 5,000 hours										
	Rated voltage	6.3V _{dc} (D55 to JA0) 6.3 to 100V _{dc}										
	Capacitance change	≤ ±30% of the initial value					≤ ±20% of the initial value					
	D.F. (tanδ)	≤ 300% of the initial specified value					≤ 200% of the initial specified value					
	Leakage current	≤ The initial specified value					≤ The initial specified value					
	Shelf Life	The following specifications shall be satisfied when the capacitors are restored to 20°C after exposing them for 1,000 hours at 105°C without voltage applied. Before the measurement, the capacitor shall be preconditioned by applying voltage according to Item 4.1 of JIS C 5101-4.										
Rated voltage		6.3V _{dc} (D55 to JA0) 6.3 to 100V _{dc}										
Capacitance change		≤ ±30% of the initial value					≤ ±20% of the initial value					
D.F. (tanδ)		≤ 300% of the initial specified value					≤ 200% of the initial specified value					
Leakage current		≤ The initial specified value					≤ The initial specified value					

◆ DIMENSIONS [mm]

- Terminal Code : A
- Size code : D55 to MN0
- Terminal Code : G
- Size code : LHO to MN0

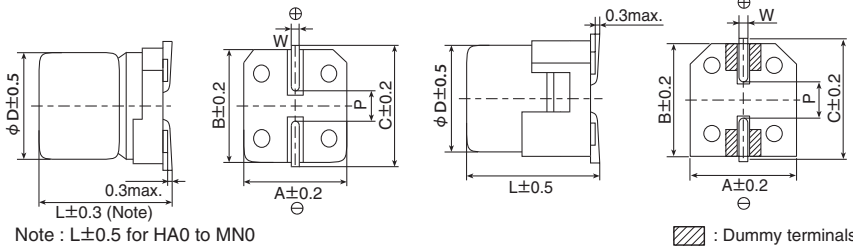

Size code	φD	L	A	B	C	W	P
D55	4	5.2	4.3	4.3	5.1	0.5 to 0.8	1.0
E55	5	5.2	5.3	5.3	5.9	0.5 to 0.8	1.4
F55	6.3	5.2	6.6	6.6	7.2	0.5 to 0.8	1.9
F61	6.3	5.8	6.6	6.6	7.2	0.5 to 0.8	1.9
F80	6.3	7.7	6.6	6.6	7.2	0.5 to 0.8	1.9
HA0	8	10.0	8.3	8.3	9.0	0.7 to 1.1	3.1
JA0	10	10.0	10.3	10.3	11.0	0.7 to 1.1	4.5
KE0	12.5	13.5	13.0	13.0	13.7	1.0 to 1.3	4.2
KG5	12.5	16.0	13.0	13.0	13.7	1.0 to 1.3	4.2
LHO	16	16.5	17.0	17.0	18.0	1.0 to 1.3	6.5
LNO	16	21.5	17.0	17.0	18.0	1.0 to 1.3	6.5
MHO	18	16.5	19.0	19.0	20.0	1.0 to 1.3	6.5
MNO	18	21.5	19.0	19.0	20.0	1.0 to 1.3	6.5

◆ PART NUMBERING SYSTEM

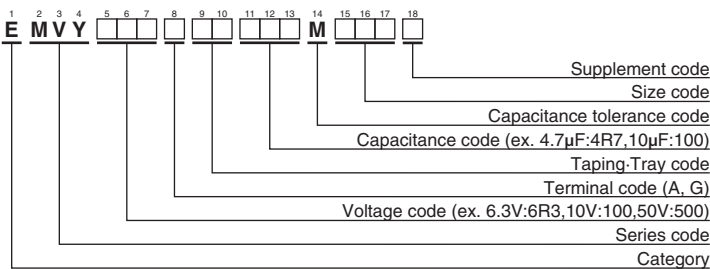

Please refer to "Product code guide (surface mount type)"

◆ MARKING

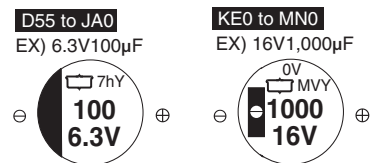

◆ STANDARD RATINGS

□ is not solvent resistant (80/100V_{dc}).

VV (V _{dc})	Cap (μF)	Size code	Impedance (Ω _{max/20°C, 100kHz})	Rated ripple current (mA _{RMS/105°C, 100kHz})	Part No.	VV (V _{dc})	Cap (μF)	Size code	Impedance (Ω _{max/20°C, 100kHz})	Rated ripple current (mA _{RMS/105°C, 100kHz})	Part No.		
6.3	22	D55	3.0	60	EMVY6R3ADA220MD55G	25	330	HA0	0.30	450	EMVY250ADA331MHA0G		
	33	E55	1.8	95	EMVY6R3ADA330ME55G		470	JA0	0.15	670	EMVY250ADA471MJA0G		
	47	F55	1.8	95	EMVY6R3ADA470ME55G		1,000	LH0	0.054	1,260	EMVY250□DA102MLH0S		
	100	F55	1.0	140	EMVY6R3ADA101MF55G		1,000	MH0	0.054	1,350	EMVY250□DA102MMH0S		
	220	F55	1.0	140	EMVY6R3ADA221MF55G		2,200	LN0	0.038	1,630	EMVY250□DA222MLN0S		
	330	F80	0.34	280	EMVY6R3ADA331MF80G		2,200	MN0	0.038	1,750	EMVY250□DA222MMN0S		
	470	HA0	0.30	450	EMVY6R3ADA471MHA0G		3,300	MN0	0.038	1,750	EMVY250□DA332MMN0S		
	680	HA0	0.30	450	EMVY6R3ADA681MHA0G		35	4.7	D55	3.0	60	EMVY350ADA4R7MD55G	
	1,000	HA0	0.30	450	EMVY6R3ADA102MHA0G			10	E55	1.8	95	EMVY350ADA100ME55G	
	1,500	JA0	0.15	670	EMVY6R3ADA152MJA0G			22	F55	1.0	140	EMVY350ADA220MF55G	
	2,200	KE0	0.070	820	EMVY6R3ARA222MKE0S			33	F55	1.0	140	EMVY350ADA330MF55G	
	2,200	LH0	0.054	1,260	EMVY6R3□DA222MLH0S			47	F55	1.0	140	EMVY350ADA470MF55G	
	3,300	KG5	0.060	950	EMVY6R3ARA332MKG5S			47	F61	1.0	140	EMVY350ADA470MF61G	
	3,300	MH0	0.054	1,350	EMVY6R3□DA332MMH0S			68	F80	0.34	280	EMVY350ADA680MF80G	
	4,700	LN0	0.038	1,630	EMVY6R3□DA472MLN0S			100	HA0	0.30	450	EMVY350ADA101MHA0G	
	4,700	MH0	0.054	1,350	EMVY6R3□DA472MMH0S			220	HA0	0.30	450	EMVY350ADA221MHA0G	
6,800	LN0	0.038	1,630	EMVY6R3□DA682MLN0S	330	JA0		0.15	670	EMVY350ADA331MJA0G			
6,800	MN0	0.038	1,750	EMVY6R3□DA682MMN0S	470	KE0		0.070	820	EMVY350ARA471MKE0S			
8,200	MN0	0.038	1,750	EMVY6R3□DA822MMN0S	470	LH0		0.054	1,260	EMVY350□DA471MLH0S			
10	22	E55	1.8	95	EMVY100ADA220ME55G	1,000		LH0	0.054	1,260	EMVY350□DA102MLH0S		
	33	E55	1.8	95	EMVY100ADA330ME55G	1,000		MH0	0.054	1,350	EMVY350□DA102MMH0S		
	47	F55	1.0	140	EMVY100ADA470MF55G	2,200		MN0	0.038	1,750	EMVY350□DA222MMN0S		
	100	F55	1.0	140	EMVY100ADA101MF55G	50		1.0	D55	5.0	30	EMVY500ADA1R0MD55G	
	220	F80	0.34	280	EMVY100ADA221MF80G		2.2	D55	5.0	30	EMVY500ADA2R2MD55G		
	330	HA0	0.30	450	EMVY100ADA331MHA0G		3.3	D55	5.0	30	EMVY500ADA3R3MD55G		
	470	HA0	0.30	450	EMVY100ADA471MHA0G		4.7	E55	3.0	50	EMVY500ADA4R7ME55G		
	680	JA0	0.15	670	EMVY100ADA681MJA0G		10	F55	2.0	70	EMVY500ADA100MF55G		
	1,000	JA0	0.15	670	EMVY100ADA102MJA0G		22	F55	2.0	70	EMVY500ADA220MF55G		
	2,200	KG5	0.060	950	EMVY100ARA222MKG5S		33	F80	0.60	170	EMVY500ADA330MF80G		
	2,200	LH0	0.054	1,260	EMVY100□DA222MLH0S		47	F80	0.60	170	EMVY500ADA470MF80G		
	3,300	LH0	0.054	1,260	EMVY100□DA332MLH0S		68	HA0	0.60	300	EMVY500ADA680MHA0G		
	3,300	MH0	0.054	1,350	EMVY100□DA332MMH0S		100	HA0	0.60	300	EMVY500ADA101MHA0G		
	4,700	LN0	0.038	1,630	EMVY100□DA472MLN0S		220	JA0	0.30	500	EMVY500ADA221MJA0G		
	4,700	MN0	0.038	1,750	EMVY100□DA472MMN0S		330	KE0	0.11	650	EMVY500ARA331MKE0S		
	6,800	MN0	0.038	1,750	EMVY100□DA682MMN0S		330	LH0	0.087	900	EMVY500□DA331MLH0S		
16	10	D55	3.0	60	EMVY160ADA100MD55G		470	LH0	0.087	900	EMVY500□DA471MLH0S		
	22	E55	1.8	95	EMVY160ADA220ME55G		470	MH0	0.087	1,060	EMVY500□DA471MMH0S		
	33	F55	1.0	140	EMVY160ADA330MF55G		1,000	MN0	0.050	1,520	EMVY500□DA102MMN0S		
	47	F55	1.0	140	EMVY160ADA470MF55G	63	68	KE0	0.19	500	EMVY630ARA680MKE0S		
	100	F55	1.0	140	EMVY160ADA101MF55G		100	KE0	0.19	500	EMVY630ARA101MKE0S		
	220	F80	0.34	280	EMVY160ADA221MF80G		220	KE0	0.19	500	EMVY630ARA221MKE0S		
	330	HA0	0.30	450	EMVY160ADA331MHA0G		220	LH0	0.12	845	EMVY630□DA221MLH0S		
	470	HA0	0.30	450	EMVY160ADA471MHA0G		330	LH0	0.12	845	EMVY630□DA331MLH0S		
	680	JA0	0.15	670	EMVY160ADA681MJA0G		330	MH0	0.12	905	EMVY630□DA331MMH0S		
	1,000	KE0	0.070	820	EMVY160ARA102MKE0S		470	LN0	0.085	1,100	EMVY630□DA471MLN0S		
	1,000	LH0	0.054	1,260	EMVY160□DA102MLH0S		470	MH0	0.12	905	EMVY630□DA471MMH0S		
	2,200	LH0	0.054	1,260	EMVY160□DA222MLH0S		80	100	KE0	0.33	450	EMVY800ARA101MKE0S	
	2,200	MH0	0.054	1,350	EMVY160□DA222MMH0S			220	KG5	0.26	550	EMVY800ARA221MKG5S	
	3,300	LN0	0.038	1,630	EMVY160□DA332MLN0S			330	LN0	0.16	900	EMVY800□DA331MLN0S	
	3,300	MH0	0.054	1,350	EMVY160□DA332MMH0S			330	MH0	0.24	700	EMVY800□DA331MMH0S	
	4,700	MN0	0.038	1,750	EMVY160□DA472MMN0S			470	MN0	0.16	950	EMVY800□DA471MMN0S	
25	10	E55	1.8	95	EMVY250ADA100ME55G			100	47	KE0	0.33	450	EMVY101ARA470MKE0S
	22	F55	1.0	140	EMVY250ADA220MF55G				68	KE0	0.33	450	EMVY101ARA680MKE0S
	33	F55	1.0	140	EMVY250ADA330MF55G				100	KE0	0.33	450	EMVY101ARA101MKE0S
	47	F55	1.0	140	EMVY250ADA470MF55G	100	LH0		0.24	650	EMVY101□DA101MLH0S		
	100	F80	0.34	280	EMVY250ADA101MF80G	220	LN0		0.16	900	EMVY101□DA221MLN0S		
	220	HA0	0.30	450	EMVY250ADA221MHA0G	220	MH0		0.24	700	EMVY101□DA221MMH0S		
						330	MN0		0.16	950	EMVY101□DA331MMN0S		

□ : Enter the appropriate terminal code.

Alchip™ - **MZF** Series

- Endurance : 10,000 hours at 105°C
- Low impedance
- Rated voltage range : 6.3 to 50V
- Nominal capacitance range : 10 to 470μF
- Suitable for high reliability products
- Solvent resistant type (see PRECAUTIONS AND GUIDELINES)
- RoHS Compliant



◆ **SPECIFICATIONS**

Items	Characteristics	
Category Temperature Range	-25 to +105°C	
Rated Voltage Range	6.3 to 50V _{dc}	
Capacitance Tolerance	±20%(M) (at 20°C, 120Hz)	
Leakage Current	I=0.01CV or 3μA, whichever is greater Where, I : Max. leakage current (μA), C : Nominal capacitance (μF), V : Rated voltage (V) (at 20°C, after 2 minutes)	
Dissipation Factor (tanδ)	Rated voltage (V _{dc})	6.3V 10V 16V 25V 35V 50V tanδ (Max.) 0.32 0.28 0.26 0.16 0.14 0.14 (at 20°C, 120Hz)
Low Temperature Characteristics (Max. Impedance Ratio)	Rated voltage (V _{dc})	6.3V 10V 16V 25V 35V 50V Z(-10°C)/Z(+20°C) 4 3 2 2 2 2 (at 120Hz)
Endurance	The following specifications shall be satisfied when the capacitors are restored to 20°C after the rated voltage is applied for 10,000 hours at 105°C.	
	Capacitance change	≤±30% of the initial value
	D.F. (tanδ)	≤300% of the initial specified value
	Leakage current	≤The initial specified value
Shelf Life	The following specifications shall be satisfied when the capacitors are restored to 20°C after exposing them for 1,000 hours at 105°C without voltage applied. Before the measurement, the capacitor shall be preconditioned by applying voltage according to Item 4.1 of JIS C 5101-4.	
	Capacitance change	≤±30% of the initial value
	D.F. (tanδ)	≤300% of the initial specified value
	Leakage current	≤The initial specified value

◆ **DIMENSIONS [mm]**

●Terminal Code : A

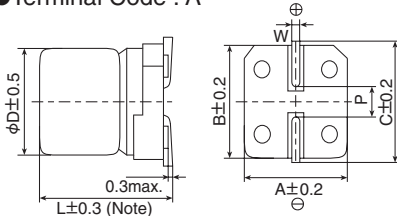

Size code	D	L	A	B	C	W	P
E73	5	7.0	5.3	5.3	5.9	0.5 to 0.8	1.4
F73	6.3	7.0	6.6	6.6	7.2	0.5 to 0.8	1.9
F90	6.3	8.7	6.6	6.6	7.2	0.5 to 0.8	1.9
HA0	8	10.0	8.3	8.3	9.0	0.7 to 1.1	3.1
JA0	10	10.0	10.3	10.3	11.0	0.7 to 1.1	4.5

◆ **PART NUMBERING SYSTEM**

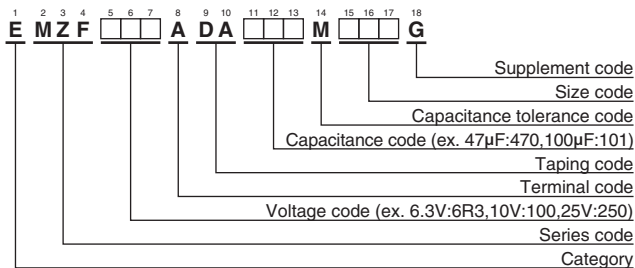

◆ **MARKING**

EX) 16V47μF



●Rated voltage symbol

Rated voltage (V _{dc})	6.3	10	16	25	35	50
Symbol	j	A	C	E	V	H

◆ **STANDARD RATINGS**

WV (V _{dc})	Cap (μF)	Size code	Impedance (Ω max/20°C, 100kHz)	Rated ripple current (mA _{rms} /105°C, 100kHz)	Part No.	WV (V _{dc})	Cap (μF)	Size code	Impedance (Ω max/20°C, 100kHz)	Rated ripple current (mA _{rms} /105°C, 100kHz)	Part No.	
6.3	47	E73	2.2	95	EMZF6R3ADA470ME73G	25	33	F73	1.1	140	EMZF250ADA330MF73G	
	100	F73	1.1	140	EMZF6R3ADA101MF73G		47	F73	1.1	140	EMZF250ADA470MF73G	
	220	F90	1.0	230	EMZF6R3ADA221MF90G		100	F90	1.0	230	EMZF250ADA101MF90G	
	330	F90	1.0	230	EMZF6R3ADA331MF90G		220	HA0	0.22	600	EMZF250ADA221MHA0G	
	470	HA0	0.22	600	EMZF6R3ADA471MHA0G		330	JA0	0.16	850	EMZF250ADA331MJA0G	
10	33	E73	2.2	95	EMZF100ADA330ME73G	35	10	E73	2.2	95	EMZF350ADA100ME73G	
	150	F73	1.1	140	EMZF100ADA151MF73G		10	F73	1.1	140	EMZF350ADA100MF73G	
16	22	E73	2.2	95	EMZF160ADA220ME73G		22	E73	2.2	95	EMZF350ADA220ME73G	
	47	F73	1.1	140	EMZF160ADA470MF73G		22	F73	1.1	140	EMZF350ADA220MF73G	
	100	F73	1.1	140	EMZF160ADA101MF73G		33	F90	1.0	230	EMZF350ADA330MF90G	
	150	F90	1.0	230	EMZF160ADA151MF90G		47	F90	1.0	230	EMZF350ADA470MF90G	
	220	F90	1.0	230	EMZF160ADA221MF90G		100	HA0	0.22	600	EMZF350ADA101MHA0G	
	330	HA0	0.22	600	EMZF160ADA331MHA0G		220	JA0	0.16	850	EMZF350ADA221MJA0G	
25	470	JA0	0.16	850	EMZF160ADA471MJA0G		50	47	HA0	0.53	350	EMZF500ADA470MHA0G
	22	E73	2.2	95	EMZF250ADA220ME73G			100	JA0	0.35	670	EMZF500ADA101MJA0G

Alchip™-**MZE** Series

- Endurance : 7,000 to 8,000 hours at 105°C
- Low impedance
- Rated voltage range : 6.3 to 50V
- Nominal capacitance range : 10 to 470μF
- Suitable for high reliability products
- Solvent resistant type (see PRECAUTIONS AND GUIDELINES)
- RoHS Compliant



◆SPECIFICATIONS

Items	Characteristics						
Category	-25 to +105°C						
Temperature Range							
Rated Voltage Range	6.3 to 50V _{dc}						
Capacitance Tolerance	±20%(M) (at 20°C, 120Hz)						
Leakage Current	I=0.01CV or 3μA, whichever is greater Where, I : Max. leakage current (μA), C : Nominal capacitance (μF), V : Rated voltage (V) (at 20°C, after 2 minutes)						
Dissipation Factor (tanδ)	Rated voltage (V _{dc})	6.3V	10V	16V	25V	35V	50V
	tanδ (Max.)	0.32	0.28	0.26	0.16	0.14	0.14
Low Temperature Characteristics (Max. Impedance Ratio)	Rated voltage(V _{dc})	6.3V	10V	16V	25V	35V	50V
	Z(-10°C)/Z(+20°C)	4	3	2	2	2	2
Endurance	The following specifications shall be satisfied when the capacitors are restored to 20°C after the rated voltage is applied for specified time at 105°C.						
	Time	E73 & F73 : 7,000 hours F90 to JA0 : 8,000 hours					
	Capacitance change	≤ ±30% of the initial value					
	D.F. (tanδ)	≤300% of the initial specified value					
	Leakage current	≤The initial specified value					
Shelf Life	The following specifications shall be satisfied when the capacitors are restored to 20°C after exposing them for 1,000 hours at 105°C without voltage applied. Before the measurement, the capacitor shall be preconditioned by applying voltage according to Item 4.1 of JIS C 5101-4.						
	Capacitance change	≤ ±30% of the initial value					
	D.F. (tanδ)	≤300% of the initial specified value					
	Leakage current	≤The initial specified value					

◆DIMENSIONS [mm]

- Terminal Code : A

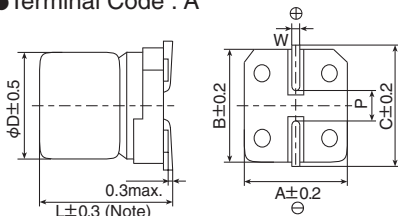

Note : L±0.5 for HA0 and JA0

Size code	D	L	A	B	C	W	P
E73	5	7.0	5.3	5.3	5.9	0.5 to 0.8	1.4
F73	6.3	7.0	6.6	6.6	7.2	0.5 to 0.8	1.9
F90	6.3	8.7	6.6	6.6	7.2	0.5 to 0.8	1.9
HA0	8	10.0	8.3	8.3	9.0	0.7 to 1.1	3.1
JA0	10	10.0	10.3	10.3	11.0	0.7 to 1.1	4.5

◆PART NUMBERING SYSTEM

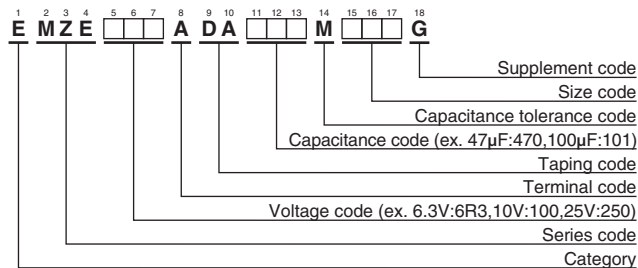

Please refer to "Product code guide (surface mount type)"

◆MARKING

EX) 16V47μF



- Rated voltage symbol

Rated voltage (V _{dc})	6.3	10	16	25	35	50
Symbol	j	A	C	E	V	H

◆STANDARD RATINGS

WV (V _{dc})	Cap (μF)	Size code	Impedance (Ω _{max} /20°C, 100kHz)	Rated ripple current (mA _{rms} /105°C, 100kHz)	Part No.	WV (V _{dc})	Cap (μF)	Size code	Impedance (Ω _{max} /20°C, 100kHz)	Rated ripple current (mA _{rms} /105°C, 100kHz)	Part No.	
6.3	47	E73	2.2	95	EMZE6R3ADA470ME73G	25	33	F73	1.1	140	EMZE250ADA330MF73G	
	100	F73	1.1	140	EMZE6R3ADA101MF73G		47	F73	1.1	140	EMZE250ADA470MF73G	
	220	F90	1.0	230	EMZE6R3ADA221MF90G		100	F90	1.0	230	EMZE250ADA101MF90G	
	330	F90	1.0	230	EMZE6R3ADA331MF90G		220	HA0	0.22	600	EMZE250ADA221MHA0G	
	470	HA0	0.22	600	EMZE6R3ADA471MHA0G		330	JA0	0.16	850	EMZE250ADA331MJA0G	
10	33	E73	2.2	95	EMZE100ADA330ME73G	35	10	E73	2.2	95	EMZE350ADA100ME73G	
	150	F73	1.1	140	EMZE100ADA151MF73G		10	F73	1.1	140	EMZE350ADA100MF73G	
16	22	E73	2.2	95	EMZE160ADA220ME73G		22	E73	2.2	95	EMZE350ADA220ME73G	
	47	F73	1.1	140	EMZE160ADA470MF73G		22	F73	1.1	140	EMZE350ADA220MF73G	
	100	F73	1.1	140	EMZE160ADA101MF73G		33	F90	1.0	230	EMZE350ADA330MF90G	
	150	F90	1.0	230	EMZE160ADA151MF90G		47	F90	1.0	230	EMZE350ADA470MF90G	
	220	F90	1.0	230	EMZE160ADA221MF90G		100	HA0	0.22	600	EMZE350ADA101MHA0G	
	330	HA0	0.22	600	EMZE160ADA331MHA0G		220	JA0	0.16	850	EMZE350ADA221MJA0G	
25	470	JA0	0.16	850	EMZE160ADA471MJA0G		50	47	HA0	0.53	350	EMZE500ADA470MHA0G
	22	E73	2.2	95	EMZE250ADA220ME73G			100	JA0	0.35	670	EMZE500ADA101MJA0G

Alchip™-**MZK** Series

- Endurance : 5,000 hours at 105°C
- Low impedance
- Rated voltage range : 6.3 to 35V
- Nominal capacitance range : 10 to 150μF
- Suitable for high reliability products
- Solvent resistant type
- RoHS Compliant

MVY $\xrightarrow{\text{Longer life}}$ **MZK**



◆SPECIFICATIONS

Items	Characteristics					
Category	-25 to +105°C					
Temperature Range	-25 to +105°C					
Rated Voltage Range	6.3 to 35V _{dc}					
Capacitance Tolerance	±20%(M) (at 20°C, 120Hz)					
Leakage Current	I=0.01CV or 3μA, whichever is greater Where, I : Max. leakage current (μA), C : Nominal capacitance (μF), V : Rated voltage (V) (at 20°C, after 2 minutes)					
Dissipation Factor (tanδ)	Rated voltage (V _{dc})	6.3V	10V	16V	25V	35V
	tanδ (Max.)	0.32	0.28	0.26	0.16	0.14
Low Temperature Characteristics (Max. Impedance Ratio)	Rated voltage(V _{dc})	6.3V	10V	16V	25V	35V
	Z(-10°C)/Z(+20°C)	4	3	2	2	2
Endurance	The following specifications shall be satisfied when the capacitors are restored to 20°C after the rated voltage is applied for 5,000 hours at 105°C.					
	Capacitance change	≤ ±30% of the initial value				
	D.F. (tanδ)	≤300% of the initial specified value				
	Leakage current	≤The initial specified value				
Shelf Life	The following specifications shall be satisfied when the capacitors are restored to 20°C after exposing them for 1,000 hours at 105°C without voltage applied. Before the measurement, the capacitor shall be preconditioned by applying voltage according to Item 4.1 of JIS C 5101-4.					
	Capacitance change	≤±30% of the initial value				
	D.F. (tanδ)	≤300% of the initial specified value				
	Leakage current	≤The initial specified value				

◆DIMENSIONS [mm]

●Terminal Code : A

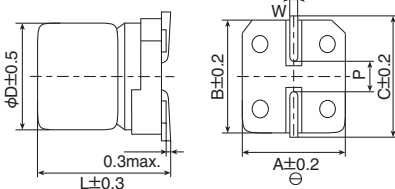

Size code	D	L	A	B	C	W	P
E61	5	5.8	5.3	5.3	5.9	0.5 to 0.8	1.4
F61	6.3	5.8	6.6	6.6	7.2	0.5 to 0.8	1.9

◆PART NUMBERING SYSTEM

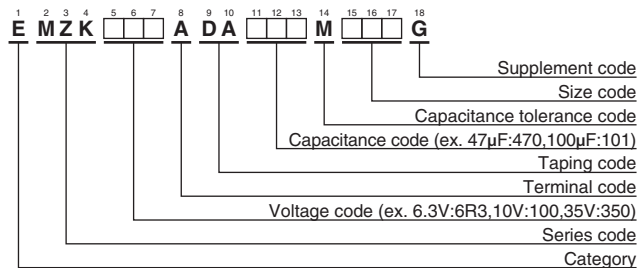

Please refer to "Product code guide (surface mount type)"

◆MARKING

EX) 35V47μF



●Rated voltage symbol

Rated voltage (V _{dc})	6.3	10	16	25	35
Symbol	j	A	C	E	V

◆STANDARD RATINGS

WV (V _{dc})	Cap (μF)	Size code	Impedance (Ωmax/20°C, 100kHz)	Rated ripple current (mArms/105°C, 100kHz)	Part No.
6.3	100	E61	2.2	95	EMZK6R3ADA101ME61G
10	150	F61	1.1	140	EMZK100ADA151MF61G
16	33	E61	2.2	95	EMZK160ADA330ME61G
	47	E61	2.2	95	EMZK160ADA470ME61G
	100	F61	1.1	140	EMZK160ADA101MF61G
25	68	F61	1.1	140	EMZK250ADA680MF61G
	10	E61	2.2	95	EMZK350ADA100ME61G
35	10	F61	1.1	140	EMZK350ADA100MF61G
	22	E61	2.2	95	EMZK350ADA220ME61G
	22	F61	1.1	140	EMZK350ADA220MF61G
	33	F61	1.1	140	EMZK350ADA330MF61G
	47	F61	1.1	140	EMZK350ADA470MF61G

Alchip™-MLA Series

- Low impedance, long life
- Rated voltage 6.3 to 50V, Capacitance 10 to 1,000μF
- Case size φ5×5.8L to φ10×10L
- Suitable for applications requiring long life and low impedance such as equipment in continuous operation, industrial applications, etc.
- Solvent resistant type (see PRECAUTIONS AND GUIDELINES)
- RoHS Compliant

MVY → Longer life → **MLA**



◆ SPECIFICATIONS

Items	Characteristics							
Category	-40 to +105°C							
Temperature Range	-40 to +105°C							
Rated Voltage Range	6.3 to 50V _{dc}							
Capacitance Tolerance	±20%(M) (20°C, 120Hz)							
Leakage Current	I=0.01CV or 3μA, whichever is greater Where, I : Max. leakage current (μA), C : Nominal capacitance (μF), V : Rated voltage (V) (at 20°C after 2 minutes)							
Dissipation Factor (tanδ)	Rated voltage(V _{dc})	6.3V	10V	16V	25V	35V	50V	
	tanδ (Max.)	E61 to F61	0.28	0.24	0.22	0.16	0.13	0.12
		F80	0.32	0.27	0.24	0.16	0.13	0.12
	HA0 to JA0	0.28	0.24	0.22	0.16	0.13	0.12	
Low Temperature Characteristics (Max. impedance Ratio)	Rated voltage(V _{dc})	6.3V	10V	16V	25V	35V	50V	
	Z(-25°C)/Z(+20°C)	4	3	2	2	2	2	
	Z(-40°C)/Z(+20°C)	10	7	5	3	3	3	
Endurance	The following specifications shall be satisfied when the capacitors are restored to 20°C after the rated voltage is applied for 3,000 hours at 105°C.							
	Capacitance change	≤±30% of the initial value						
	D.F. (tanδ)	≤300% of the initial specified value						
	Leakage current	≤The initial specified value						
Shelf life	The following specifications shall be satisfied when the capacitors are restored to 20°C after exposing them for 1,000 hours at 105°C without voltage applied. Before the measurement, the capacitor shall be preconditioned by applying voltage according to Item 4.1 of JIS C 5101-4.							
	Capacitance change	≤±30% of the initial value						
	D.F. (tanδ)	≤300% of the initial specified value						
	Leakage current	≤The initial specified value						

◆ DIMENSIONS [mm]

● Terminal Code : A

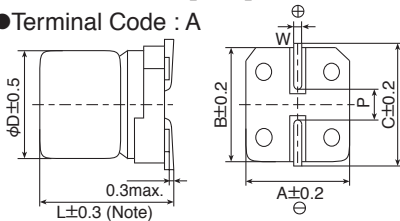

Note : L±0.5 for HA0 and JA0

Size code	D	L	A	B	C	W	P
E61	5	5.8	5.3	5.3	5.9	0.5 to 0.8	1.4
F61	6.3	5.8	6.6	6.6	7.2	0.5 to 0.8	1.9
F80	6.3	7.7	6.6	6.6	7.2	0.5 to 0.8	1.9
HA0	8	10.0	8.3	8.3	9.0	0.7 to 1.1	3.1
JA0	10	10.0	10.3	10.3	11.0	0.7 to 1.1	4.5

◆ MARKING

EX) 16V100μF



● Rated voltage symbol

Rated voltage (V _{dc})	Symbol
6.3	j
10	A
16	C
25	E
35	V
50	H

◆ PART NUMBERING SYSTEM

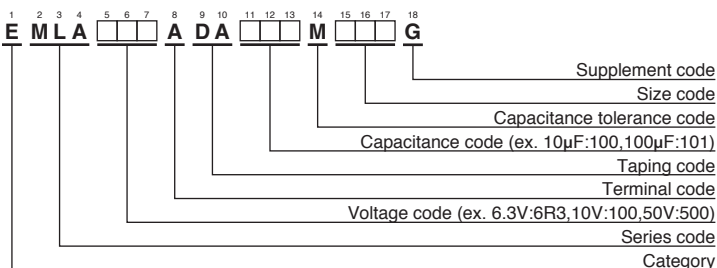

Please refer to "Product code guide (surface mount type)"

◆STANDARD RATINGS

WV (Vdc)	Cap (μF)	Size code	tanδ	Impedance (Ω _{max} /20°C, 100kHz)	Rated ripple current (mA _{rms} /105°C, 100kHz)	Part No.	WV (Vdc)	Cap (μF)	Size code	tanδ	Impedance (Ω _{max} /20°C, 100kHz)	Rated ripple current (mA _{rms} /105°C, 100kHz)	Part No.
6.3	47	E61	0.28	1.30	95	EMLA6R3ADA470ME61G	25	33	F61	0.16	0.70	140	EMLA250ADA330MF61G
	100	F61	0.28	0.70	140	EMLA6R3ADA101MF61G		47	F61	0.16	0.70	140	EMLA250ADA470MF61G
	150	F61	0.28	0.70	140	EMLA6R3ADA151MF61G		47	F80	0.16	0.70	230	EMLA250ADA470MF80G
	220	F80	0.32	0.70	230	EMLA6R3ADA221MF80G		100	F80	0.16	0.70	230	EMLA250ADA101MF80G
	330	F80	0.32	0.70	230	EMLA6R3ADA331MF80G		100	HA0	0.16	0.16	600	EMLA250ADA101MHA0G
	330	HA0	0.28	0.16	600	EMLA6R3ADA331MHA0G		150	HA0	0.16	0.16	600	EMLA250ADA151MHA0G
	470	HA0	0.28	0.16	600	EMLA6R3ADA471MHA0G		220	HA0	0.16	0.16	600	EMLA250ADA221MHA0G
1,000	JA0	0.28	0.08	850	EMLA6R3ADA102MJA0G	330	HA0	0.16	0.16	600	EMLA250ADA331MHA0G		
10	33	E61	0.24	1.30	95	EMLA100ADA330ME61G	330	JA0	0.16	0.08	850	EMLA250ADA331MJA0G	
	47	F61	0.24	0.70	140	EMLA100ADA470MF61G	470	JA0	0.16	0.08	850	EMLA250ADA471MJA0G	
	100	F61	0.24	0.70	140	EMLA100ADA101MF61G	35	10	E61	0.13	1.30	95	EMLA350ADA100ME61G
	150	F61	0.24	0.70	140	EMLA100ADA151MF61G		22	F61	0.13	0.70	140	EMLA350ADA220MF61G
	220	F80	0.27	0.70	230	EMLA100ADA221MF80G		33	F61	0.13	0.70	140	EMLA350ADA330MF61G
	220	HA0	0.24	0.16	600	EMLA100ADA221MHA0G		33	F80	0.13	0.70	230	EMLA350ADA330MF80G
	330	HA0	0.24	0.16	600	EMLA100ADA331MHA0G		47	F80	0.13	0.70	230	EMLA350ADA470MF80G
470	HA0	0.24	0.16	600	EMLA100ADA471MHA0G	100		F80	0.13	0.70	230	EMLA350ADA101MF80G	
22	E61	0.22	1.30	95	EMLA160ADA220ME61G	100		HA0	0.13	0.16	600	EMLA350ADA101MHA0G	
33	F61	0.22	0.70	140	EMLA160ADA330MF61G	150	HA0	0.13	0.16	600	EMLA350ADA151MHA0G		
47	F61	0.22	0.70	140	EMLA160ADA470MF61G	220	HA0	0.13	0.16	600	EMLA350ADA221MHA0G		
100	F61	0.22	0.70	140	EMLA160ADA101MF61G	220	JA0	0.13	0.08	850	EMLA350ADA221MJA0G		
100	F80	0.24	0.70	230	EMLA160ADA101MF80G	330	JA0	0.13	0.08	850	EMLA350ADA331MJA0G		
150	F80	0.24	0.70	230	EMLA160ADA151MF80G	50	10	F61	0.12	2.00	70	EMLA500ADA100MF61G	
220	F80	0.24	0.70	230	EMLA160ADA221MF80G		22	F61	0.12	2.00	70	EMLA500ADA220MF61G	
220	HA0	0.22	0.16	600	EMLA160ADA221MHA0G		33	F80	0.12	1.60	100	EMLA500ADA330MF80G	
330	HA0	0.22	0.16	600	EMLA160ADA331MHA0G		47	F80	0.12	1.60	100	EMLA500ADA470MF80G	
470	HA0	0.22	0.16	600	EMLA160ADA471MHA0G		47	HA0	0.12	0.34	350	EMLA500ADA470MHA0G	
470	JA0	0.22	0.08	850	EMLA160ADA471MJA0G		100	HA0	0.12	0.34	350	EMLA500ADA101MHA0G	
10	E61	0.16	1.30	95	EMLA250ADA100ME61G		100	JA0	0.12	0.18	670	EMLA500ADA101MJA0G	
22	E61	0.16	1.30	95	EMLA250ADA220ME61G	150	JA0	0.12	0.18	670	EMLA500ADA151MJA0G		
22	F61	0.16	0.70	140	EMLA250ADA220MF61G	220	JA0	0.12	0.18	670	EMLA500ADA221MJA0G		

Alchip™-MLF Series

- Endurance : 10,000 hours at 105°C
- Rated voltage range : 6.3 to 50V
- Nominal capacitance range : 1.0 to 1,000μF
- Suitable for high reliability products
- Solvent resistant type (see PRECAUTIONS AND GUIDELINES)
- RoHS Compliant

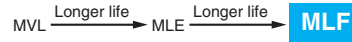

◆SPECIFICATIONS

Items	Characteristics						
Category	-25 to +105°C						
Temperature Range	-25 to +105°C						
Rated Voltage Range	6.3 to 50V _{dc}						
Capacitance Tolerance	±20%(M) (at 20°C, 120Hz)						
Leakage Current	I=0.03CV or 4μA, whichever is greater (at 20°C, after 2 minutes)						
Dissipation Factor (tanδ)	Rated voltage (V _{dc})	6.3V	10V	16V	25V	35V	50V
	tanδ (Max.)	0.32	0.28	0.26	0.16	0.14	0.14
Low Temperature Characteristics (Max. Impedance Ratio)	Rated voltage (V _{dc})	6.3V	10V	16V	25V	35V	50V
	Z(-10°C)/Z(+20°C)	4	3	2	2	2	2
Endurance	The following specifications shall be satisfied when the capacitors are restored to 20°C after the rated voltage is applied for 10,000 hours at 105°C.						
	Capacitance change	≤±30% of the initial value					
	D.F. (tanδ)	≤300% of the initial specified value					
	Leakage current	≤The initial specified value					
Shelf Life	The following specifications shall be satisfied when the capacitors are restored to 20°C after exposing them for 1,000 hours at 105°C without voltage applied. Before the measurement, the capacitor shall be preconditioned by applying voltage according to Item 4.1 of JIS C 5101-4.						
	Capacitance change	≤±30% of the initial value					
	D.F. (tanδ)	≤300% of the initial specified value					
	Leakage current	≤The initial specified value					

◆DIMENSIONS [mm]

●Terminal Code : A

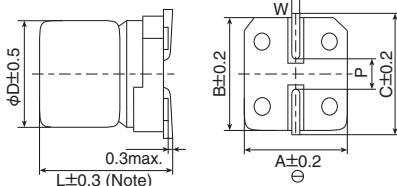

Size code	D	L	A	B	C	W	P
D73	4	7.0	4.3	4.3	5.1	0.5 to 0.8	1.0
E73	5	7.0	5.3	5.3	5.9	0.5 to 0.8	1.4
F73	6.3	7.0	6.6	6.6	7.2	0.5 to 0.8	1.9
F90	6.3	8.7	6.6	6.6	7.2	0.5 to 0.8	1.9
HA0	8	10.0	8.3	8.3	9.0	0.7 to 1.1	3.1
JA0	10	10.0	10.3	10.3	11.0	0.7 to 1.1	4.5

◆PART NUMBERING SYSTEM

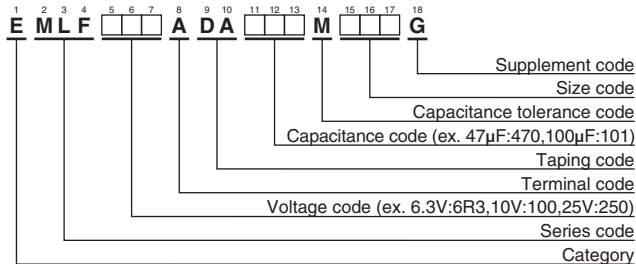

Please refer to "Product code guide (surface mount type)"

◆MARKING

EX) 16V47μF

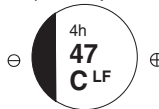

●Rated voltage symbol

Rated voltage (V _{dc})	6.3	10	16	25	35	50
Symbol	j	A	C	E	V	H

◆STANDARD RATINGS

WV (V _{dc})	Cap (μF)	Size code	Rated ripple current (mArms/105°C, 120Hz)	Part No.	WV (V _{dc})	Cap (μF)	Size code	Rated ripple current (mArms/105°C, 120Hz)	Part No.
6.3	22	D73	22	EMLF6R3ADA220MD73G	35	1.0	D73	6.2	EMLF350ADA1R0MD73G
	47	E73	36	EMLF6R3ADA470ME73G		2.2	D73	11	EMLF350ADA2R2MD73G
	100	F73	60	EMLF6R3ADA101MF73G		3.3	D73	14	EMLF350ADA3R3MD73G
	220	F90	101	EMLF6R3ADA221MF90G		4.7	D73	15	EMLF350ADA4R7MD73G
	330	HA0	160	EMLF6R3ADA331MHA0G		4.7	E73	19	EMLF350ADA4R7ME73G
	1,000	JA0	313	EMLF6R3ADA102MJA0G		10	E73	25	EMLF350ADA100ME73G
10	33	E73	35	EMLF100ADA330ME73G		10	F73	30	EMLF350ADA100MF73G
	220	HA0	141	EMLF100ADA221MHA0G		22	F73	42	EMLF350ADA220MF73G
	10	D73	18	EMLF160ADA100MD73G		22	F90	49	EMLF350ADA4R7ME73G
16	22	E73	30	EMLF160ADA220ME73G		33	F90	57	EMLF350ADA330MF90G
	47	F73	50	EMLF160ADA470MF73G		220	JA0	216	EMLF350ADA221MJA0G
	100	F90	81	EMLF160ADA101MF90G		50	33	HA0	77
	470	JA0	254	EMLF160ADA471MJA0G	47		HA0	92	EMLF500ADA470MHA0G
25	33	F73	48	EMLF250ADA330MF73G	100		JA0	151	EMLF500ADA101MJA0G
	47	F90	63	EMLF250ADA470MF90G					
	100	HA0	116	EMLF250ADA101MHA0G					

Alchip™-MLE Series

- Endurance : 7,000 to 8,000 hours at 105°C
- Rated voltage range : 6.3 to 50V
- Nominal capacitance range : 1.0 to 1,000µF
- Suitable for high reliability products
- Solvent resistant type (see PRECAUTIONS AND GUIDELINES)
- RoHS Compliant

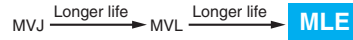

◆SPECIFICATIONS

Items	Characteristics						
Category	-25 to +105°C						
Temperature Range							
Rated Voltage Range	6.3 to 50V _{dc}						
Capacitance Tolerance	±20%(M) (at 20°C, 120Hz)						
Leakage Current	I=0.03CV or 4µA, whichever is greater Where, I : Max. leakage current (µA), C : Nominal capacitance (µF), V : Rated voltage (V) (at 20°C, after 2 minutes)						
Dissipation Factor (tanδ)	Rated voltage (V _{dc})	6.3V	10V	16V	25V	35V	50V
	tanδ (Max.)	0.32	0.28	0.26	0.16	0.14	0.14
Low Temperature Characteristics (Max. Impedance Ratio)	Rated voltage(V _{dc})	6.3V	10V	16V	25V	35V	50V
	Z(-10°C)/Z(+20°C)	4	3	2	2	2	2
Endurance	The following specifications shall be satisfied when the capacitors are restored to 20°C after the rated voltage is applied for specified time at 105°C.						
	Time	D73 to F73 : 7,000 hours F90 to JA0 : 8,000 hours					
	Capacitance change	≤±30% of the initial value					
	D.F. (tanδ)	≤300% of the initial specified value					
	Leakage current	≤The initial specified value					
Shelf Life	The following specifications shall be satisfied when the capacitors are restored to 20°C after exposing them for 1,000 hours at 105°C without voltage applied. Before the measurement, the capacitor shall be preconditioned by applying voltage according to Item 4.1 of JIS C 5101-4.						
	Capacitance change	≤±30% of the initial value					
	D.F. (tanδ)	≤300% of the initial specified value					
	Leakage current	≤The initial specified value					

◆DIMENSIONS [mm]

●Terminal Code : A

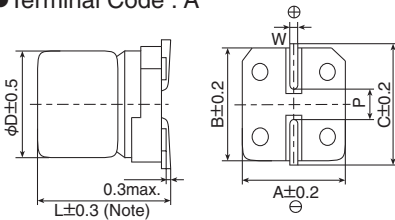

Note : L±0.5 for HA0 and JA0

Size code	D	L	A	B	C	W	P
D73	4	7.0	4.3	4.3	5.1	0.5 to 0.8	1.0
E73	5	7.0	5.3	5.3	5.9	0.5 to 0.8	1.4
F73	6.3	7.0	6.6	6.6	7.2	0.5 to 0.8	1.9
F90	6.3	8.7	6.6	6.6	7.2	0.5 to 0.8	1.9
HA0	8	10.0	8.3	8.3	9.0	0.7 to 1.1	3.1
JA0	10	10.0	10.3	10.3	11.0	0.7 to 1.1	4.5

◆PART NUMBERING SYSTEM

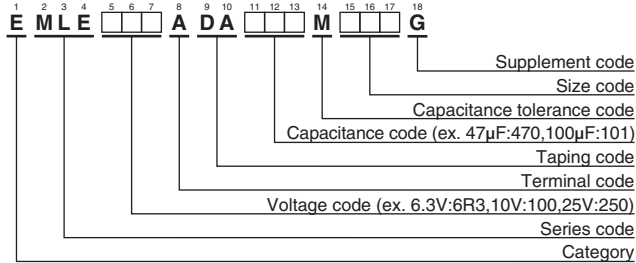

Please refer to "Product code guide (surface mount type)"

◆MARKING

EX) 16V47µF



●Rated voltage symbol

Rated voltage (V _{dc})	6.3	10	16	25	35	50
Symbol	j	A	C	E	V	H

◆STANDARD RATINGS

WV (V _{dc})	Cap (µF)	Size code	Rated ripple current (mA _{rms} /105°C, 120Hz)	Part No.	WV (V _{dc})	Cap (µF)	Size code	Rated ripple current (mA _{rms} /105°C, 120Hz)	Part No.
6.3	22	D73	22	EMLE6R3ADA220MD73G	35	1.0	D73	6.2	EMLE350ADA1R0MD73G
	47	E73	36	EMLE6R3ADA470ME73G		2.2	D73	11	EMLE350ADA2R2MD73G
	100	F73	60	EMLE6R3ADA101MF73G		3.3	D73	14	EMLE350ADA3R3MD73G
	220	F90	101	EMLE6R3ADA221MF90G		4.7	D73	15	EMLE350ADA4R7MD73G
	330	HA0	160	EMLE6R3ADA331MHA0G		4.7	E73	19	EMLE350ADA4R7ME73G
1,000	JA0	313	EMLE6R3ADA102MJA0G	10		E73	25	EMLE350ADA100ME73G	
10	33	E73	35	EMLE100ADA330ME73G		10	F73	30	EMLE350ADA100MF73G
	220	HA0	141	EMLE100ADA221MHA0G		22	F73	42	EMLE350ADA220MF73G
16	10	D73	18	EMLE160ADA100MD73G		22	F90	49	EMLE350ADA220MF90G
	22	E73	30	EMLE160ADA220ME73G		33	F90	57	EMLE350ADA330MF90G
	47	F73	50	EMLE160ADA470MF73G	220	JA0	216	EMLE350ADA221MJA0G	
	100	F90	81	EMLE160ADA101MF90G	50	33	HA0	77	EMLE500ADA330MHA0G
470	JA0	254	EMLE160ADA471MJA0G	47		HA0	92	EMLE500ADA470MHA0G	
33	F73	48	EMLE250ADA330MF73G	100		JA0	151	EMLE500ADA101MJA0G	
25	47	F90	63	EMLE250ADA470MF90G					
	100	HA0	116	EMLE250ADA101MHA0G					

Alchip™-MLK Series

- 6.1mm height
- Endurance : 5,000 hours at 105°C
- Rated voltage range : 6.3 to 35V
- Nominal capacitance range : 4.7 to 100μF
- Suitable to fit for downsized equipment
- Solvent resistant type (see PRECAUTIONS AND GUIDELINES)
- RoHS Compliant

MVL $\xrightarrow{\text{Longer life}}$ **MLK**

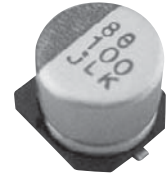

SPECIFICATIONS

Items	Characteristics					
Category	-25 to +105°C					
Temperature Range	-25 to +105°C					
Rated Voltage Range	6.3 to 35V _{dc}					
Capacitance Tolerance	±20%(M) (at 20°C, 120Hz)					
Leakage Current	I=0.03CV or 4μA, whichever is greater Where, I : Max. leakage current (μA), C : Nominal capacitance (μF), V : Rated voltage (V) (at 20°C, after 2 minutes)					
Dissipation Factor (tanδ)	Rated voltage (V _{dc})	6.3V	10V	16V	25V	35V
	tanδ (Max.)	0.32	0.28	0.26	0.16	0.14
Low Temperature Characteristics (Max. Impedance Ratio)	Rated voltage(V _{dc})	6.3V	10V	16V	25V	35V
	Z(-10°C)/Z(+20°C)	4	3	2	2	2
Endurance	The following specifications shall be satisfied when the capacitors are restored to 20°C after the rated voltage is applied for 5,000 hours at 105°C.					
	Capacitance change	≤±30% of the initial value				
	D.F. (tanδ)	≤300% of the initial specified value				
	Leakage current	≤The initial specified value				
Shelf Life	The following specifications shall be satisfied when the capacitors are restored to 20°C after exposing them for 1,000 hours at 105°C without voltage applied. Before the measurement, the capacitor shall be preconditioned by applying voltage according to Item 4.1 of JIS C 5101-4.					
	Capacitance change	≤±30% of the initial value				
	D.F. (tanδ)	≤300% of the initial specified value				
	Leakage current	≤The initial specified value				

DIMENSIONS [mm]

● Terminal Code : A

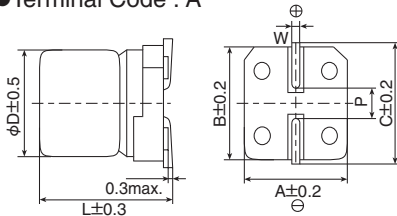

Size code	D	L	A	B	C	W	P
E61	5	5.8	5.3	5.3	5.9	0.5 to 0.8	1.4
F61	6.3	5.8	6.6	6.6	7.2	0.5 to 0.8	1.9

PART NUMBERING SYSTEM

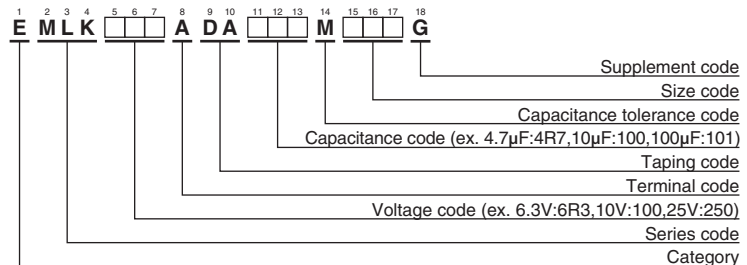

Please refer to "Product code guide (surface mount type)"

MARKING

EX) 35V10μF



● Rated voltage symbol

Rated voltage (V _{dc})	6.3	10	16	25	35
Symbol	j	A	C	E	V

STANDARD RATINGS

WV (V _{dc})	Cap (μF)	Size code	tanδ	Rated ripple current (mArms/105°C,120Hz)	Part No.
6.3	47	E61	0.32	36	EMLK6R3ADA470ME61G
	100	F61	0.32	60	EMLK6R3ADA101MF61G
10	33	E61	0.28	35	EMLK100ADA330ME61G
16	22	E61	0.26	30	EMLK160ADA220ME61G
	47	F61	0.26	50	EMLK160ADA470MF61G
25	33	F61	0.16	48	EMLK250ADA330MF61G
	4.7	E61	0.14	19	EMLK350ADA4R7ME61G
35	10	E61	0.14	25	EMLK350ADA100ME61G
	10	F61	0.14	30	EMLK350ADA100MF61G
	22	F61	0.14	42	EMLK350ADA220MF61G

Alchip™-MVL Series

- Endurance : 3,000 to 5,000 hours at 105°C
- Suitable for applications requiring long life such as continuously operating equipment, industrial applications, etc
- Solvent resistant type (see PRECAUTIONS AND GUIDELINES)
- RoHS Compliant

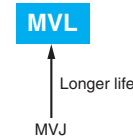

◆SPECIFICATIONS

Items	Characteristics						
Category	-40 to +105°C						
Temperature Range							
Rated Voltage Range	6.3 to 50V _{dc}						
Capacitance Tolerance	±20%(M) (at 20°C, 120Hz)						
Leakage Current	I=0.03CV or 4μA, whichever is greater Where, I : Max. leakage current (μA), C : Nominal capacitance (μF), V : Rated voltage (V) (at 20°C, after 2 minutes)						
Dissipation Factor (tanδ)	Rated voltage (V _{dc})	6.3V	10V	16V	25V	35V	50V
	Max. tanδ	0.28	0.24	0.20	0.16	0.13	0.12
Low Temperature Characteristics (Max. impedance Ratio)	Rated voltage (V _{dc})	6.3V	10V	16V	25V	35V	50V
	Z(-25°C)/Z(+20°C)	4	3	2	2	2	2
	Z(-40°C)/Z(+20°C)	10	7	5	3	3	3
Endurance	After the capacitors are subjected to the rated DC voltage for 3,000 hours (HA0 & JA0 sizes 5,000 hours) at 105°C, the following specifications shall be satisfied when the capacitors are restored to 20°C.						
	Capacitance change	≤±30% of the initial value					
	D.F. (tanδ)	≤300% of the initial specified value					
	Leakage current	≤The initial specified value					
Shelf Life	The following specifications shall be satisfied when the capacitors are restored to 20°C after exposing them for 1,000 hours at 105°C without voltage applied. Before the measurement, the capacitor shall be preconditioned by applying voltage according to Item 4.1 of JIS C 5101-4.						
	Capacitance change	≤±30% of the initial value					
	D.F. (tanδ)	≤300% of the initial specified value					
	Leakage current	≤The initial specified value					

◆DIMENSIONS [mm]

●Terminal Code : A

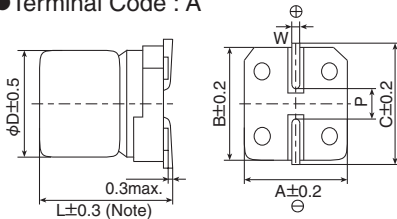

Note : L±0.5 for HA0 and JA0

Size code	D	L	A	B	C	W	P
D60	4	5.7	4.3	4.3	5.1	0.5 to 0.8	1.0
E60	5	5.7	5.3	5.3	5.9	0.5 to 0.8	1.4
F60	6.3	5.7	6.6	6.6	7.2	0.5 to 0.8	1.9
F80	6.3	7.7	6.6	6.6	7.2	0.5 to 0.8	1.9
HA0	8	10.0	8.3	8.3	9.0	0.7 to 1.1	3.1
JA0	10	10.0	10.3	10.3	11.0	0.7 to 1.1	4.5

◆PART NUMBERING SYSTEM

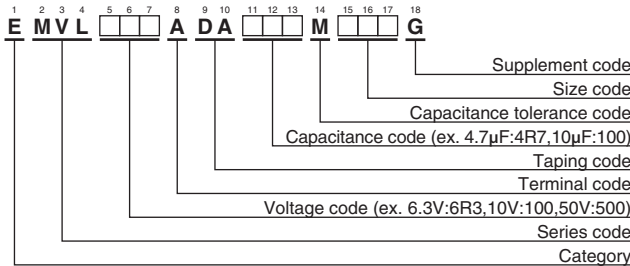

Please refer to "Product code guide (surface mount type)"

◆MARKING

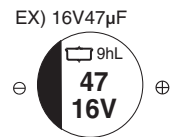

◆STANDARD RATINGS

WV (V _{dc})	Cap (μF)	Size code	tanδ	Rated ripple current (mArms/105°C, 120Hz)	Part No.
6.3	22	D60	0.28	22	EMVL6R3ADA220MD60G
	47	E60	0.28	36	EMVL6R3ADA470ME60G
	100	F60	0.28	60	EMVL6R3ADA101MF60G
	220	F80	0.28	101	EMVL6R3ADA221MF80G
	330	HA0	0.28	160	EMVL6R3ADA331MHA0G
10	1,000	JA0	0.28	313	EMVL6R3ADA102MJA0G
	33	E60	0.24	35	EMVL100ADA330ME60G
16	220	HA0	0.24	141	EMVL100ADA221MHA0G
	10	D60	0.20	18	EMVL160ADA100MD60G
	22	E60	0.20	30	EMVL160ADA220ME60G
	47	F60	0.20	50	EMVL160ADA470MF60G
	100	F80	0.20	81	EMVL160ADA101MF80G
25	470	JA0	0.20	254	EMVL160ADA471MJA0G
	33	F60	0.16	48	EMVL250ADA330MF60G
	47	F80	0.16	63	EMVL250ADA470MF80G
	100	HA0	0.16	116	EMVL250ADA101MHA0G
35	330	JA0	0.16	238	EMVL250ADA331MJA0G
	4.7	D60	0.13	15	EMVL350ADA4R7MD60G
	10	E60	0.13	25	EMVL350ADA100ME60G
	22	F60	0.13	42	EMVL350ADA220MF60G
	33	F80	0.13	57	EMVL350ADA330MF80G
50	220	JA0	0.13	216	EMVL350ADA221MJA0G
	1.0	D60	0.12	6.2	EMVL500ADA1R0MD60G
	2.2	D60	0.12	11	EMVL500ADA2R2MD60G
	3.3	D60	0.12	14	EMVL500ADA3R3MD60G
	4.7	E60	0.12	19	EMVL500ADA4R7ME60G
	10	F60	0.12	30	EMVL500ADA100MF60G
	22	F80	0.12	49	EMVL500ADA220MF80G
	33	HA0	0.12	77	EMVL500ADA330MHA0G
	47	HA0	0.12	92	EMVL500ADA470MHA0G
	100	JA0	0.12	151	EMVL500ADA101MJA0G

Alchip™ - MVJ Series

- Endurance : 2,000 hours at 105°C
- Solvent resistant type
- RoHS Compliant

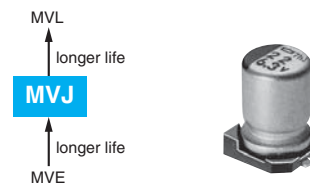

◆ SPECIFICATIONS

Items	Characteristics						
Category Temperature Range	-40 to +105°C						
Rated Voltage Range	6.3 to 50V _{dc}						
Capacitance Tolerance	±20% (M) (at 20°C, 120Hz)						
Leakage Current	I=0.01CV or 3μA, whichever is greater. Where, I : Max. leakage current (μA), C : Nominal capacitance (μF), V : Rated voltage (V) (at 20°C after 2 minutes)						
Dissipation Factor (tanδ)	Rated voltage (V _{dc})	6.3V	10V	16V	25V	35V	50V
	tanδ (Max.)	0.30	0.24	0.20	0.16	0.14	0.12
Low Temperature Characteristics (Max. Impedance Ratio)	Rated voltage (V _{dc})	6.3V	10V	16V	25V	35V	50V
	Z(-25°C)/Z(+20°C)	4	3	2	2	2	2
	Z(-40°C)/Z(+20°C)	12	8	6	4	3	3
Endurance	The following specifications shall be satisfied when the capacitors are restored to 20°C after the rated voltage is applied for 2,000 hours at 105°C.						
	Rated voltage	6.3V _{dc}		10 & 16V _{dc}		25 to 50V _{dc}	
	Capacitance change	≤±30% of the initial value		≤±25% of the initial value		≤±20% of the initial value	
	D.F. (tanδ)	≤300% of the initial specified value		≤300% of the initial specified value		≤200% of the initial specified value	
	Leakage current	≤The initial specified value		≤The initial specified value		≤The initial specified value	
Shelf Life	The following specifications shall be satisfied when the capacitors are restored to 20°C after exposing them for 1,000 hours at 105°C without voltage applied. Before the measurement, the capacitor shall be preconditioned by applying voltage according to Item 4.1 of JIS C 5101-4.						
	Rated voltage	6.3V _{dc}		10 & 16V _{dc}		25 to 50V _{dc}	
	Capacitance change	≤±30% of the initial value		≤±25% of the initial value		≤±20% of the initial value	
	D.F. (tanδ)	≤300% of the initial specified value		≤300% of the initial specified value		≤200% of the initial specified value	
	Leakage current	≤The initial specified value		≤The initial specified value		≤The initial specified value	

◆ DIMENSIONS [mm]

- Terminal Code : A

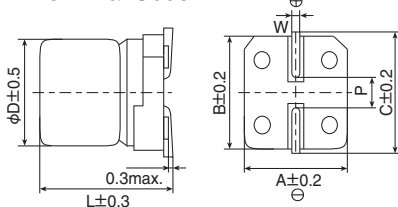

Size code	D	L	A	B	C	W	P
D60	4	5.7	4.3	4.3	5.1	0.5 to 0.8	1.0
E60	5	5.7	5.3	5.3	5.9	0.5 to 0.8	1.4
F60	6.3	5.7	6.6	6.6	7.2	0.5 to 0.8	1.9

◆ PART NUMBERING SYSTEM

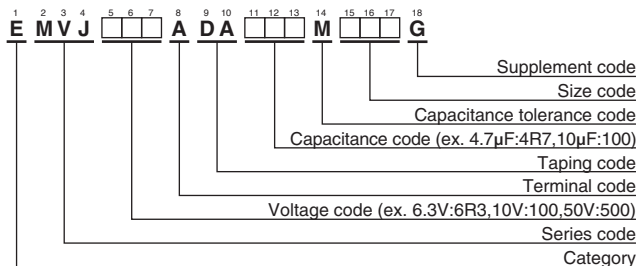

Please refer to "Product code guide (surface mount type)"

◆ MARKING

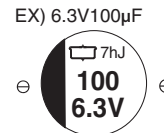

◆ STANDARD RATINGS

WV (V _{dc})	Cap (μF)	Size code	tanδ	Rated ripple current (mArms/105°C, 120Hz)	Part No.	WV (V _{dc})	Cap (μF)	Size code	tanδ	Rated ripple current (mArms/105°C, 120Hz)	Part No.
6.3	22	D60	0.30	21	EMVJ6R3ADA220MD60G	35	4.7	D60	0.14	15	EMVJ350ADA4R7MD60G
	47	E60	0.30	36	EMVJ6R3ADA470ME60G		10	E60	0.14	25	EMVJ350ADA100ME60G
	100	F60	0.30	56	EMVJ6R3ADA101MF60G		22	F60	0.14	40	EMVJ350ADA220MF60G
10	33	E60	0.24	34	EMVJ100ADA330ME60G	50	1.0	D60	0.12	5.6	EMVJ500ADA1R0MD60G
	10	D60	0.20	16	EMVJ160ADA100MD60G		2.2	D60	0.12	10	EMVJ500ADA2R2MD60G
	22	E60	0.20	30	EMVJ160ADA220ME60G		3.3	D60	0.12	14	EMVJ500ADA3R3MD60G
47	F60	0.20	48	EMVJ160ADA470MF60G	4.7		E60	0.12	19	EMVJ500ADA4R7ME60G	
25	33	F60	0.16	45	EMVJ250ADA330MF60G		10	F60	0.12	29	EMVJ500ADA100MF60G



Alchip™-MVH Series

- Lower ESR, Higher ripple current
- Endurance : 1,000 to 5,000 hours at 125°C
- Suitable to fit for automotive equipment
- Solvent resistant type (10 to 50V)
- RoHS Compliant

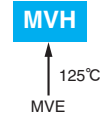

◆ SPECIFICATIONS

Items	Characteristics													
Category Temperature Range	-40 to +125°C													
Rated Voltage Range	10 to 450V _{dc}													
Capacitance Tolerance	±20% (M) (at 20°C, 120Hz)													
Leakage Current	Rated voltage (V _{dc})	10 to 100V _{dc}						160 to 450V _{dc}						
	F60 to JA0	I=0.01CV or 3μA, whichever is greater.												
	KE0 to MN0	I=0.03CV or 4μA, whichever is greater.												
Where, I : Max. leakage current (μA), C : Nominal capacitance (μF), V : Rated voltage (V) (at 20°C after 2 minutes)														
Dissipation Factor (tanδ)	Rated voltage (V _{dc})	10V	16V	25V	35V	50V	63V	80V	100V	160 to 250V	400 & 450V			
	tanδ (Max.)	F60 to JA0	0.24	0.20	0.16	0.14	0.14	0.12	0.12	0.10	—	—		
		KE0 to MN0	0.22	0.18	0.16	0.14	0.12	0.14	—	0.10	0.20	0.24		
When nominal capacitance exceeds 1,000μF, add 0.02 to the value above for each 1,000μF increase. (at 20°C, 120Hz)														
Low Temperature Characteristics (Max. Impedance Ratio)	Rated voltage (V _{dc})	10V	16V	25V	35V	50V	63V	80V	100V	160 to 250V	400 & 450V			
	F60 to JA0	Z(-25°C)/Z(+20°C)	3	2	2	2	2	2	2	2	—	—		
		Z(-40°C)/Z(+20°C)	6	4	4	3	3	3	3	3	—	—		
	KE0 to MN0	Z(-25°C)/Z(+20°C)	4	3	2	2	2	2	—	2	3	6		
Z(-40°C)/Z(+20°C)		8	6	4	3	3	3	—	3	6	10	(at 120Hz)		
Endurance	The following specifications shall be satisfied when the capacitors are restored to 20°C after the rated voltage is applied for the specified time at 125°C.													
	Time	F60 to H63 (10 to 100V _{dc}) : 1,000hours HA0 to JA0 (10 to 100V _{dc}) : 2,000hours KE0 to MN0 (10 to 100V _{dc}) : 5,000hours KE0 to MN0 (160 to 450V _{dc}) : 2,000hours												
	Capacitance change	≤ ±30% of the initial value												
	D.F. (tanδ)	≤ 300% of the initial specified value												
	Leakage current	≤ The initial specified value												
Shelf Life	The following specifications shall be satisfied when the capacitors are restored to 20°C after exposing them for 1,000 hours (500 hours for 400 to 450V _{dc}) at 125°C without voltage applied. Before the measurement, the capacitor shall be preconditioned by applying voltage according to Item 4.1 of JIS C 5101-4.													
	Rated voltage(V _{dc})	10 to 50V _{dc}						63 to 450V _{dc}						
	Capacitance change	≤ ±30% of the initial value						≤ ±30% of the initial value						
	D.F. (tanδ)	≤ 300% of the initial specified value						≤ 300% of the initial specified value						
	Leakage current	≤ The initial specified value						≤ 500% of the initial specified value						

◆ DIMENSIONS [mm]

- Terminal Code : A
- Size code : F60 to MN0

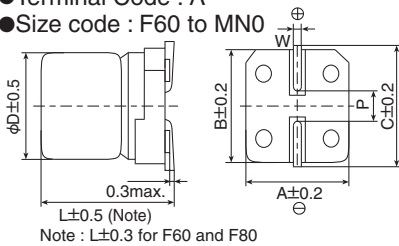

- Terminal Code : G
- Size code : LH0 to MN0

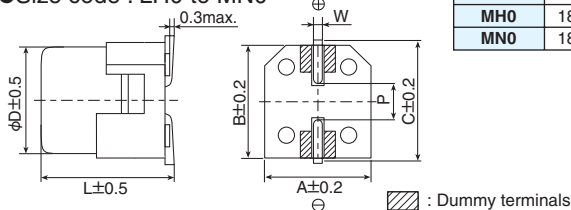

Size code	D	L	A	B	C	W	P
F60	6.3	5.7	6.6	6.6	7.2	0.5 to 0.8	1.9
F80	6.3	7.7	6.6	6.6	7.2	0.5 to 0.8	1.9
H63	8	6.3	8.3	8.3	9.0	0.5 to 0.8	2.3
HA0	8	10.0	8.3	8.3	9.0	0.7 to 1.1	3.1
JA0	10	10.0	10.3	10.3	11.0	0.7 to 1.1	4.5
KE0	12.5	13.5	13.0	13.0	13.7	1.0 to 1.3	4.2
KG5	12.5	16.0	13.0	13.0	13.7	1.0 to 1.3	4.2
LH0	16	16.5	17.0	17.0	18.0	1.0 to 1.3	6.5
LN0	16	21.5	17.0	17.0	18.0	1.0 to 1.3	6.5
MH0	18	16.5	19.0	19.0	20.0	1.0 to 1.3	6.5
MN0	18	21.5	19.0	19.0	20.0	1.0 to 1.3	6.5

◆ MARKING

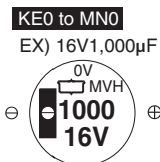
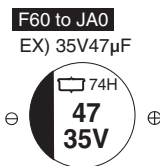

Alchip™-MVH Series

◆ PART NUMBERING SYSTEM

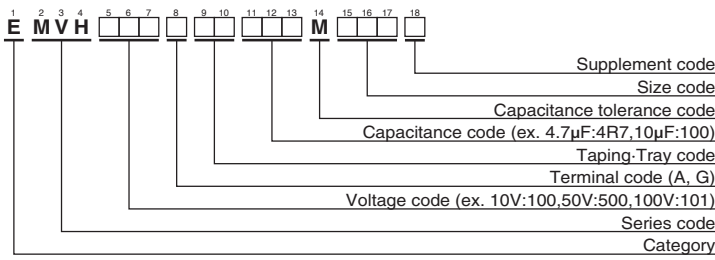

Please refer to "Product code guide (surface mount type)"

◆ STANDARD RATINGS

□ is not solvent resistant (63 to 450V_{dc}).

WV (Vdc)	Cap (μF)	Size code	ESR (Ω max/100kHz)		Rated ripple current (mArms/125°C)		Part No.		
			20°C	-40°C	100kHz	120Hz			
10	100	F80	0.90	14.0	110	—	EMVH100ADA101MF80G		
	100	H63	0.90	14.0	110	—	EMVH100ADA101MH63G		
	220	F80	0.90	14.0	110	—	EMVH100ADA221MF80G		
	220	H63	0.90	14.0	110	—	EMVH100ADA221MH63G		
	220	HA0	0.40	6.0	220	—	EMVH100ADA221MHA0G		
	330	HA0	0.40	6.0	220	—	EMVH100ADA331MHA0G		
	330	JA0	0.30	4.5	296	—	EMVH100ADA331MJA0G		
	470	JA0	0.30	4.5	296	—	EMVH100ADA471MJA0G		
	1,000	KE0	0.14	2.1	750	—	EMVH100ARA102MKE0S		
	2,200	LH0	0.10	1.5	1,000	—	EMVH100□DA222MLH0S		
	2,200	MH0	0.10	1.5	1,200	—	EMVH100□DA222MMH0S		
	3,300	MH0	0.10	1.5	1,200	—	EMVH100□DA332MMH0S		
16	47	F60	1.6	24.0	69	—	EMVH160ADA470MF60G		
	100	HA0	0.40	6.0	220	—	EMVH160ADA101MHA0G		
	220	HA0	0.40	6.0	220	—	EMVH160ADA221MHA0G		
	220	JA0	0.30	4.5	296	—	EMVH160ADA221MJA0G		
	330	JA0	0.30	4.5	296	—	EMVH160ADA331MJA0G		
	470	KE0	0.14	2.1	750	—	EMVH160ARA471MKE0S		
	680	KE0	0.14	2.1	750	—	EMVH160ARA681MKE0S		
	680	LH0	0.10	1.5	1,000	—	EMVH160□DA681MLH0S		
	1,000	MH0	0.10	1.5	1,200	—	EMVH160□DA102MMH0S		
	2,200	MH0	0.10	1.5	1,200	—	EMVH160□DA222MMH0S		
	25	33	F60	1.6	24.0	69	—	EMVH250ADA330MF60G	
		47	F80	0.90	14.0	110	—	EMVH250ADA470MF80G	
47		H63	0.90	14.0	110	—	EMVH250ADA470MH63G		
100		F80	0.90	14.0	110	—	EMVH250ADA101MF80G		
100		H63	0.90	14.0	110	—	EMVH250ADA101MH63G		
100		HA0	0.40	6.0	220	—	EMVH250ADA101MHA0G		
220		HA0	0.40	6.0	220	—	EMVH250ADA221MHA0G		
220		JA0	0.30	4.5	296	—	EMVH250ADA221MJA0G		
330		JA0	0.30	4.5	296	—	EMVH250ADA331MJA0G		
330		KE0	0.14	2.1	750	—	EMVH250ARA331MKE0S		
470		KE0	0.14	2.1	750	—	EMVH250ARA471MKE0S		
470		LH0	0.10	1.5	1,000	—	EMVH250□DA471MLH0S		
35	10	F60	1.6	24.0	69	—	EMVH350ADA100MF60G		
	22	F60	1.6	24.0	69	—	EMVH350ADA220MF60G		
	33	F80	0.90	14.0	110	—	EMVH350ADA330MF80G		
	33	H63	0.90	14.0	110	—	EMVH350ADA330MH63G		
	47	F80	0.90	14.0	110	—	EMVH350ADA470MF80G		
	47	H63	0.90	14.0	110	—	EMVH350ADA470MH63G		
	47	HA0	0.40	6.0	220	—	EMVH350ADA470MHA0G		
	100	HA0	0.40	6.0	220	—	EMVH350ADA101MHA0G		
	100	JA0	0.30	4.5	296	—	EMVH350ADA101MJA0G		
	220	JA0	0.30	4.5	296	—	EMVH350ADA221MJA0G		
	330	KE0	0.14	2.1	750	—	EMVH350ARA331MKE0S		
	330	LH0	0.10	1.5	1,000	—	EMVH350□DA331MLH0S		
50	10	F60	2.8	42.0	51	—	EMVH500ADA100MF60G		
	10	H63	1.6	30.0	83	—	EMVH500ADA100MH63G		
	22	F80	2.0	30.0	83	—	EMVH500ADA220MF80G		
	22	H63	1.6	30.0	83	—	EMVH500ADA220MH63G		
	50	33	F80	0.90	14.0	110	—	EMVH500ADA330MF80G	
		33	H63	0.90	14.0	110	—	EMVH500ADA330MH63G	
		47	F80	0.90	14.0	110	—	EMVH500ADA470MF80G	
		47	H63	0.90	14.0	110	—	EMVH500ADA470MH63G	
		47	HA0	0.40	6.0	220	—	EMVH500ADA470MHA0G	
		100	HA0	0.40	6.0	220	—	EMVH500ADA101MHA0G	
		100	JA0	0.30	4.5	296	—	EMVH500ADA101MJA0G	
		220	JA0	0.30	4.5	296	—	EMVH500ADA221MJA0G	
330		KE0	0.14	2.1	750	—	EMVH500ARA331MKE0S		
330		LH0	0.10	1.5	1,000	—	EMVH500□DA331MLH0S		
470		KG5	0.11	1.5	900	—	EMVH500ARA471MKG5S		
470		LH0	0.10	1.5	1,000	—	EMVH500□DA471MLH0S		
50	680	MH0	0.10	1.5	1,200	—	EMVH500□DA681MMH0S		
	50	10	F60	2.8	42.0	51	—	EMVH500ADA100MF60G	
		10	H63	1.6	30.0	83	—	EMVH500ADA100MH63G	
		22	F80	2.0	30.0	83	—	EMVH500ADA220MF80G	
		22	H63	1.6	30.0	83	—	EMVH500ADA220MH63G	
		50	33	F80	0.90	14.0	110	—	EMVH500ADA330MF80G
			33	H63	0.90	14.0	110	—	EMVH500ADA330MH63G
			47	F80	0.90	14.0	110	—	EMVH500ADA470MF80G
			47	H63	0.90	14.0	110	—	EMVH500ADA470MH63G
			47	HA0	0.40	6.0	220	—	EMVH500ADA470MHA0G
			100	HA0	0.40	6.0	220	—	EMVH500ADA101MHA0G
			100	JA0	0.30	4.5	296	—	EMVH500ADA101MJA0G
220			JA0	0.30	4.5	296	—	EMVH500ADA221MJA0G	
330	KE0		0.14	2.1	750	—	EMVH500ARA331MKE0S		
330	LH0		0.10	1.5	1,000	—	EMVH500□DA331MLH0S		
470	KG5		0.11	1.5	900	—	EMVH500ARA471MKG5S		
470	LH0		0.10	1.5	1,000	—	EMVH500□DA471MLH0S		
50	680	MH0	0.10	1.5	1,200	—	EMVH500□DA681MMH0S		
	50	10	F60	2.8	42.0	51	—	EMVH500ADA100MF60G	
		10	H63	1.6	30.0	83	—	EMVH500ADA100MH63G	
		22	F80	2.0	30.0	83	—	EMVH500ADA220MF80G	
		22	H63	1.6	30.0	83	—	EMVH500ADA220MH63G	
		50	33	F80	0.90	14.0	110	—	EMVH500ADA330MF80G
			33	H63	0.90	14.0	110	—	EMVH500ADA330MH63G
			47	F80	0.90	14.0	110	—	EMVH500ADA470MF80G
			47	H63	0.90	14.0	110	—	EMVH500ADA470MH63G
			47	HA0	0.40	6.0	220	—	EMVH500ADA470MHA0G
			100	HA0	0.40	6.0	220	—	EMVH500ADA101MHA0G
			100	JA0	0.30	4.5	296	—	EMVH500ADA101MJA0G
220			JA0	0.30	4.5	296	—	EMVH500ADA221MJA0G	
330	KE0		0.14	2.1	750	—	EMVH500ARA331MKE0S		
330	LH0		0.10	1.5	1,000	—	EMVH500□DA331MLH0S		
470	KG5		0.11	1.5	900	—	EMVH500ARA471MKG5S		
470	LH0		0.10	1.5	1,000	—	EMVH500□DA471MLH0S		
50	680	MH0	0.10	1.5	1,200	—	EMVH500□DA681MMH0S		
	50	10	F60	2.8	42.0	51	—	EMVH500ADA100MF60G	
		10	H63	1.6	30.0	83	—	EMVH500ADA100MH63G	
		22	F80	2.0	30.0	83	—	EMVH500ADA220MF80G	
		22	H63	1.6	30.0	83	—	EMVH500ADA220MH63G	
		50	33	F80	0.90	14.0	110	—	EMVH500ADA330MF80G
			33	H63	0.90	14.0	110	—	EMVH500ADA330MH63G
			47	F80	0.90	14.0	110	—	EMVH500ADA470MF80G
			47	H63	0.90	14.0	110	—	EMVH500ADA470MH63G
			47	HA0	0.40	6.0	220	—	EMVH500ADA470MHA0G
			100	HA0	0.40	6.0	220	—	EMVH500ADA101MHA0G
			100	JA0	0.30	4.5	296	—	EMVH500ADA101MJA0G
220			JA0	0.30	4.5	296	—	EMVH500ADA221MJA0G	
330	KE0		0.14	2.1	750	—	EMVH500ARA331MKE0S		
330	LH0		0.10	1.5	1,000	—	EMVH500□DA331MLH0S		
470	KG5		0.11	1.5	900	—	EMVH500ARA471MKG5S		
470	LH0		0.10	1.5	1,000	—	EMVH500□DA471MLH0S		
50	680	MH0	0.10	1.5	1,200	—	EMVH500□DA681MMH0S		
	50	10	F60	2.8	42.0	51	—	EMVH500ADA100MF60G	
		10	H63	1.6	30.0	83	—	EMVH500ADA100MH63G	
		22	F80	2.0	30.0	83	—	EMVH500ADA220MF80G	
		22	H63	1.6	30.0	83	—	EMVH500ADA220MH63G	
		50	33	F80	0.90	14.0	110	—	EMVH500ADA330MF80G
			33	H63	0.90	14.0	110	—	EMVH500ADA330MH63G
			47	F80	0.90	14.0	110	—	EMVH500ADA470MF80G
			47	H63	0.90	14.0	110	—	EMVH500ADA470MH63G
			47	HA0	0.40	6.0	220	—	EMVH500ADA470MHA0G
			100	HA0	0.40	6.0	220	—	EMVH500ADA101MHA0G
			100	JA0	0.30	4.5	296	—	EMVH500ADA101MJA0G
220			JA0	0.30	4.5	296	—	EMVH500ADA221MJA0G	
330	KE0		0.14	2.1	750	—	EMVH500ARA331MKE0S		
330	LH0		0.10	1.5	1,000	—	EMVH500□DA331MLH0S		
470	KG5		0.11	1.5	900	—	EMVH500ARA471MKG5S		
470	LH0		0.10	1.5	1,000	—	EMVH500□DA471MLH0S		
50	680	MH0	0.10	1.5	1,200	—	EMVH500□DA681MMH0S		
	50	10	F60	2.8	42.0	51	—	EMVH500ADA100MF60G	
		10	H63	1.6	30.0	83	—	EMVH500ADA100MH63G	
		22	F80	2.0	30.0	83	—	EMVH500ADA220MF80G	
		22	H63	1.6	30.0	83	—	EMVH500ADA220MH63G	
		50	33	F80	0.90	14.0	110	—	EMVH500ADA330MF80G
			33	H63	0.90	14.0	110	—	EMVH500ADA330MH63G
			47	F80	0.90	14.0	110	—	EMVH500ADA470MF80G
			47	H63	0.90	14.0	110	—	EMVH500ADA470MH63G
			47	HA0	0.40	6.0	220	—	EMVH500ADA470MHA0G
			100	HA0	0.40	6.0	220	—	EMVH500ADA101MHA0G
			100	JA0	0.30	4.5	296	—	EMVH500ADA101MJA0G
220			JA0	0.30	4.5	296	—		

Alchip™-MHB Series

- ESR : Less than MVH
- Endurance : 2,000 hours at 125°C
- Rated Voltage Range : 10 to 35V
- Nominal capacitance range : 47 to 470μF
- Solvent resistant type
- RoHS Compliant

MHB

↑ Lower ESR
MVH



◆ SPECIFICATIONS

Items	Characteristics				
Category	-40 to +125°C				
Temperature Range	-40 to +125°C				
Rated Voltage Range	10 to 35V _{dc}				
Capacitance Tolerance	±20%(M) (20°C, 120Hz)				
Leakage Current	I=0.01CV Where, I : Max. leakage current (μA), C : Nominal capacitance (μF), V : Rated voltage (V) (at 20°C after 2 minutes)				
Dissipation Factor (tanδ)	Rated voltage(V _{dc})	10V	16V	25V	35V
	tanδ (Max.)	0.24	0.20	0.16	0.14
Low Temperature Characteristics (Max. impedance Ratio)	Rated voltage(V _{dc})	10V	16V	25V	35V
	Z(-25°C)/Z(+20°C)	3	2	2	2
	Z(-40°C)/Z(+20°C)	4	3	3	3
Endurance	The following specifications shall be satisfied when the capacitors are restored to 20°C after the rated voltage is applied for 2,000 hours at 125°C.				
	Capacitance change	≤±30% of the initial value			
	D.F. (tanδ)	≤300% of the initial specified value			
	Leakage current	≤The initial specified value			
	ESR(-40°C, 400kHz)	HA0 : ≤ 6Ω JA0 : ≤ 4.5Ω			
Shelf Life	The following specifications shall be satisfied when the capacitors are restored to 20°C after exposing them for 1,000 hours at 125°C without voltage applied. Before the measurement, the capacitor shall be preconditioned by applying voltage according to Item 4.1 of JIS C 5101-4.				
	Capacitance change	≤±30% of the initial value			
	D.F. (tanδ)	≤300% of the initial specified value			
	Leakage current	≤The initial specified value			

◆ DIMENSIONS [mm]

● Terminal Code : A

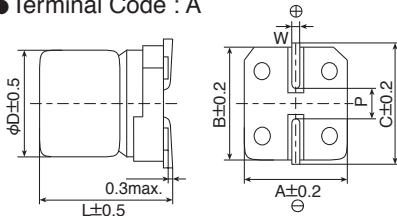

Size code	D	L	A	B	C	W	P
HA0	8	10.0	8.3	8.3	9.0	0.7 to 1.1	3.1
JA0	10	10.0	10.3	10.3	11.0	0.7 to 1.1	4.5

◆ PART NUMBERING SYSTEM

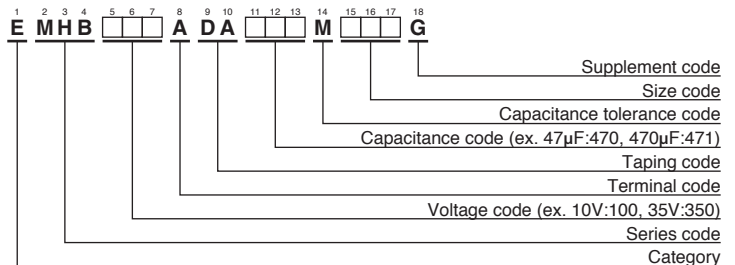

Please refer to "Product code guide (surface mount type)"

◆ MARKING

EX) 16V220μF



● Rated voltage symbol

Rated voltage (V _{dc})	Symbol
10	A
16	C
25	E
35	V

◆ STANDARD RATINGS

VV(V _{dc})	Cap(μF)	Size code	ESR (Ω max/100k to 400kHz)		Rated ripple current (mArms/125°C, 100k to 400kHz)	Part No.
			20°C	-40°C		
10	330	HA0	0.3	3.0	240	EMHB100ADA331MHA0G
	470	JA0	0.2	2.0	330	EMHB100ADA471MJA0G
16	100	HA0	0.3	3.0	240	EMHB160ADA101MHA0G
	220	HA0	0.3	3.0	240	EMHB160ADA221MHA0G
25	100	HA0	0.3	3.0	240	EMHB250ADA101MHA0G
	220	HA0	0.3	3.0	240	EMHB250ADA221MHA0G
	330	JA0	0.2	2.0	330	EMHB250ADA331MJA0G
35	47	HA0	0.3	3.0	240	EMHB350ADA470MHA0G
	100	HA0	0.3	3.0	240	EMHB350ADA101MHA0G
	100	JA0	0.2	2.0	330	EMHB350ADA101MJA0G
	220	JA0	0.2	2.0	330	EMHB350ADA221MJA0G

Alchip™-MHJ Series

- Endurance : 2,000 hours at 125°C
- Rated voltage range : 10 to 35V
- Nominal capacitance range : 47 to 470μF
- Solvent resistant type (see PRECAUTIONS AND GUIDELINES)
- RoHS Compliant



◆SPECIFICATIONS

Items	Characteristics					
Category	-40 to +125°C					
Temperature Range	-40 to +125°C					
Rated Voltage Range	10 to 35V _{dc}					
Capacitance Tolerance	±20%(M) (20°C, 120Hz)					
Leakage Current	I=0.01CV (at 20°C after 2 minutes) Where, I : Max. leakage current (μA), C : Nominal capacitance (μF), V : Rated voltage (V)					
Dissipation Factor (tanδ)	Rated voltage(V _{dc})	10V	16V	25V	35V	(20°C, 120Hz)
	tanδ (Max.)	0.30	0.23	0.18	0.16	
Low Temperature Characteristics (Max. impedance Ratio)	Rated voltage(V _{dc})	10V	16V	25V	35V	(120Hz)
	Z(-25°C)/Z(+20°C)	3	2	2	2	
	Z(-40°C)/Z(+20°C)	4	3	3	3	
Endurance	The following specifications shall be satisfied when the capacitors are restored to 20°C after the rated voltage is applied for 2,000 hours at 125°C.					
	Capacitance change	≤±30% of the initial value				
	D.F. (tanδ)	≤300% of the initial specified value				
	Leakage current	≤The initial specified value				
	ESR (Ω max./100kHz)		F80	HA0	JA0	
		20°C	3.5	0.60	0.40	
		-40°C	40	4.5	3.5	
Shelf Life	The following specifications shall be satisfied when the capacitors are restored to 20°C after exposing them for 1,000 hours at 125°C without voltage applied. Before the measurement, the capacitor shall be preconditioned by applying voltage according to Item 4.1 of JIS C 5101-4.					
	Capacitance change	≤±30% of the initial value				
	D.F. (tanδ)	≤300% of the initial specified value				
	Leakage current	≤The initial specified value				

◆DIMENSIONS [mm]

●Terminal Code : A

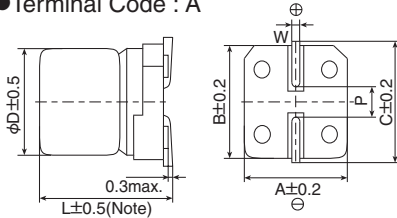

Note : L±0.3 for F80

Size code	φD	L	A	B	C	W	P
F80	6.3	7.7	6.6	6.6	7.2	0.5 to 0.8	1.9
HA0	8	10.0	8.3	8.3	9.0	0.7 to 1.1	3.1
JA0	10	10.0	10.3	10.3	11.0	0.7 to 1.1	4.5

◆PART NUMBERING SYSTEM

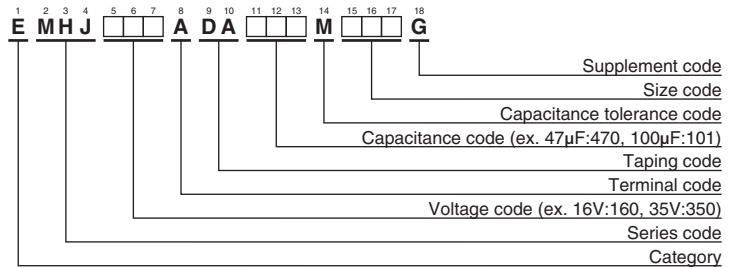

Please refer to "Product code guide (surface mount type)"

◆MARKING

EX) 16V100μF



●Rated voltage symbol

Rated voltage (V _{dc})	Symbol
10	A
16	C
25	E
35	V

◆STANDARD RATINGS

WV(V _{dc})	Cap(μF)	Size code	ESR (Ω max./100kHz)		Rated ripple current (mA _{rms} /125°C, 100kHz)	Part No.
			20°C	-40°C		
10	220	HA0	0.15	3.0	350	EMHJ100ADA221MHA0G
	330	HA0	0.15	3.0	350	EMHJ100ADA331MHA0G
	330	JA0	0.12	2.0	550	EMHJ100ADA331MJA0G
	470	JA0	0.12	2.0	550	EMHJ100ADA471MJA0G
16	100	F80	0.45	5.0	220	EMHJ160ADA101MF80G
	100	HA0	0.15	3.0	350	EMHJ160ADA101MHA0G
	220	HA0	0.15	3.0	350	EMHJ160ADA221MHA0G
	330	JA0	0.12	2.0	550	EMHJ160ADA331MJA0G
25	100	JA0	0.12	2.0	550	EMHJ250ADA101MJA0G
	220	JA0	0.12	2.0	550	EMHJ250ADA221MJA0G
	330	JA0	0.12	2.0	550	EMHJ250ADA331MJA0G
	470	JA0	0.12	2.0	550	EMHJ250ADA471MJA0G
35	47	F80	0.45	5.0	220	EMHJ350ADA470MF80G
	47	HA0	0.15	3.0	350	EMHJ350ADA470MHA0G
	100	HA0	0.15	3.0	350	EMHJ350ADA101MHA0G
	220	JA0	0.12	2.0	550	EMHJ350ADA221MJA0G

Alchip™-MKB Series

- Low ESR
- Endurance : 3,000 hours at 105°C
- Rated voltage 400V, Capacitance 2.2 to 4.7μF
- RoHS Compliant



◆ SPECIFICATIONS

Items	Characteristics	
Category	-40 to +105°C	
Temperature Range		
Rated Voltage Range	400V _{dc}	
Capacitance Tolerance	±20%(M) (20°C, 120Hz)	
Leakage Current	I=0.04CV+100(max.) Where, I : Max. leakage current (μA), C : Nominal capacitance (μF), V : Rated voltage (V) (at 20°C after 1 minute)	
Dissipation Factor (tanδ)	Rated voltage(V _{dc})	400V
	tanδ (Max.)	0.25 (20°C, 120Hz)
Low Temperature Characteristics (Max. impedance Ratio)	Rated voltage(V _{dc})	400V
	Z(-25°C)/Z(+20°C)	6 (120Hz)
	Z(-40°C)/Z(+20°C)	10 (120Hz)
Endurance	The following specifications shall be satisfied when the capacitors are restored to 20°C after the rated voltage is applied for 3,000 hours at 105°C.	
	Capacitance change	≤±20% of the initial value
	D.F. (tanδ)	≤200% of the initial specified value
	Leakage current	≤The initial specified value
Shelf life	The following specifications shall be satisfied when the capacitors are restored to 20°C after exposing them for 500 hours at 105°C without voltage applied. Before the measurement, the capacitor shall be preconditioned by applying voltage according to Item 4.1 of JIS C 5101-4.	
	Capacitance change	≤±20% of the initial value
	D.F. (tanδ)	≤200% of the initial specified value
	Leakage current	≤The initial specified value

◆ DIMENSIONS [mm]

● Terminal Code : A

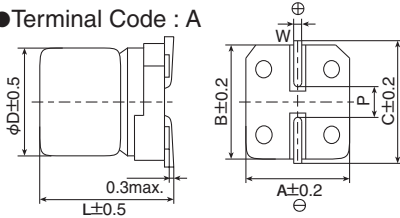

Size code	D	L	A	B	C	W	P
HA0	8	10.0	8.3	8.3	9.0	0.7 to 1.1	3.1
JA0	10	10.0	10.3	10.3	11.0	0.7 to 1.1	4.5

◆ MARKING

EX) 400V3.9μF



● Rated voltage symbol

Rated voltage (V _{dc})	Symbol
400	2G

◆ PART NUMBERING SYSTEM

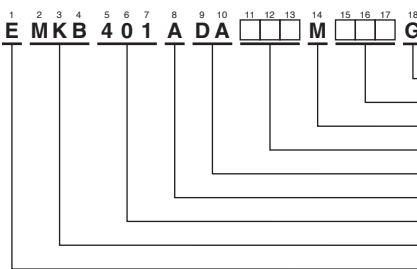

Please refer to "Product code guide (surface mount type)"

◆ STANDARD RATINGS

WV (V _{dc})	Cap (μF)	Size code	ESR (Ω _{max} /120Hz)		Rated ripple current (mA _{rms} /105°C, 120Hz)	Part No.
			20°C	-40°C		
400	2.2	HA0	20	1,000	26	EMKB401ADA2R2MHA0G
	3.3	JA0	10	500	37	EMKB401ADA3R3MJA0G
	3.9	JA0	10	500	38	EMKB401ADA3R9MJA0G
	4.7	JA0	10	500	39	EMKB401ADA4R7MJA0G

Alchip™ - MV-BP Series

- Bi-polar chip type for the circuit, of which polarity is frequently reversed
- Solvent resistant type (see PRECAUTIONS AND GUIDELINES)
- RoHS Compliant



◆ SPECIFICATIONS

Items	Characteristics						
Category	-40 to +85°C						
Temperature Range	-40 to +85°C						
Rated Voltage Range	6.3 to 50V _{dc}						
Capacitance Tolerance	±20% (M) (at 20°C, 120Hz)						
Leakage Current	I=0.05CV or 10μA, whichever is greater. Where, I : Max. leakage current (μA), C : Nominal capacitance (μF), V : Rated voltage (V) (at 20°C after 2 minutes)						
Dissipation Factor (tanδ)	Rated voltage (V _{dc})	6.3V	10V	16V	25V	35V	50V
	tanδ (Max.)	0.32	0.26	0.24	0.22	0.20	0.20
Low Temperature Characteristics (Max. Impedance Ratio)	Rated voltage (V _{dc})	6.3V	10V	16V	25V	35V	50V
	Z(-25°C)/Z(+20°C)	4	3	2	2	2	2
	Z(-40°C)/Z(+20°C)	10	8	6	4	3	3
Endurance	The following specifications shall be satisfied when the capacitors are restored to 20°C after the rated voltage is applied for 2,000 hours at 85°C, however the polarization shall be reversed every 250 hours.						
	Capacitance change	≤±20% of the initial value					
	D.F. (tanδ)	≤200% of the initial specified value					
	Leakage current	≤The initial specified value					
Shelf Life	The following specifications shall be satisfied when the capacitors are restored to 20°C after exposing them for 500 hours at 85°C without voltage applied. Before the measurement, the capacitor shall be preconditioned by applying voltage according to Item 4.1 of JIS C 5101-4.						
	Capacitance change	≤±15% of the initial value					
	D.F. (tanδ)	≤150% of the initial specified value					
	Leakage current	≤The initial specified value					

◆ DIMENSIONS [mm]

- Terminal Code : A

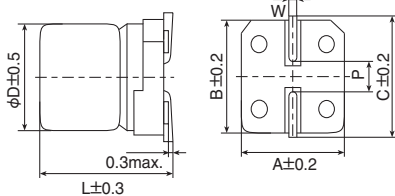

Size code	D	L	A	B	C	W	P
D55	4	5.2	4.3	4.3	5.1	0.5 to 0.8	1.0
E55	5	5.2	5.3	5.3	5.9	0.5 to 0.8	1.4
F55	6.3	5.2	6.6	6.6	7.2	0.5 to 0.8	1.9

◆ PART NUMBERING SYSTEM

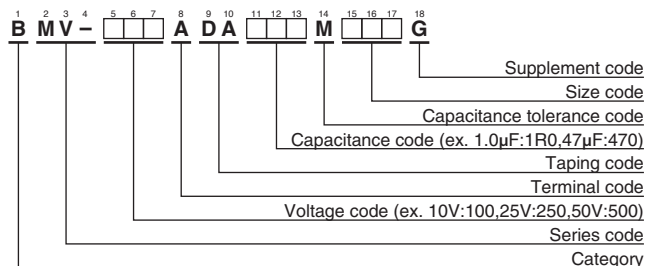

Please refer to "Product code guide (surface mount type)"

◆ MARKING

EX) 35V4.7μF

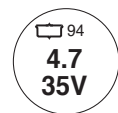

◆ STANDARD RATINGS

WV (V _{dc})	Cap (μF)	Size code	tanδ	Rated ripple current (mArms/85°C, 120Hz)	Part No.
6.3	10	D55	0.32	13	BMV-6R3ADA100MD55G
	22	E55	0.32	23	BMV-6R3ADA220ME55G
	47	F55	0.32	36	BMV-6R3ADA470MF55G
10	33	F55	0.26	33	BMV-100ADA330MF55G
16	4.7	D55	0.24	11	BMV-160ADA4R7MD55G
	10	E55	0.24	18	BMV-160ADA100ME55G
	22	F55	0.24	28	BMV-160ADA220MF55G
25	3.3	D55	0.22	9.0	BMV-250ADA3R3MD55G
35	2.2	D55	0.20	8.0	BMV-350ADA2R2MD55G
	4.7	E55	0.20	13	BMV-350ADA4R7ME55G
	10	F55	0.20	21	BMV-350ADA100MF55G
50	1.0	D55	0.20	5.5	BMV-500ADA1R0MD55G
	2.2	E55	0.20	9.0	BMV-500ADA2R2ME55G
	3.3	E55	0.20	11	BMV-500ADA3R3ME55G
	4.7	F55	0.20	14	BMV-500ADA4R7MF55G

Alchip™-MVK-BP Series

- Bi-polar chip type for the circuit, of which polarity is frequently reversed
- Solvent resistant type (see PRECAUTIONS AND GUIDELINES)
- RoHS Compliant



◆SPECIFICATIONS

Items	Characteristics						
Category	-40 to +105°C						
Temperature Range	-40 to +105°C						
Rated Voltage Range	6.3 to 50V _{dc}						
Capacitance Tolerance	±20% (M) (at 20°C, 120Hz)						
Leakage Current	I=0.05CV or 10μA, whichever is greater. (at 20°C after 2 minutes) Where, I : Max. leakage current (μA), C : Nominal capacitance (μF), V : Rated voltage (V)						
Dissipation Factor (tanδ)	Rated voltage (V _{dc})	6.3V	10V	16V	25V	35V	50V
	tanδ (Max.)	0.35	0.26	0.24	0.20	0.18	0.18
Low Temperature Characteristics (Max. Impedance Ratio)	Rated voltage (V _{dc})	6.3V	10V	16V	25V	35V	50V
	Z(-25°C)/Z(+20°C)	4	3	2	2	2	2
	Z(-40°C)/Z(+20°C)	10	8	6	4	3	3
Endurance	The following specifications shall be satisfied when the capacitors are restored to 20°C after the rated voltage is applied for 1,000 hours at 105°C, however the polarization shall be reversed every 250 hours.						
	Capacitance change	≤±30% of the initial value					
	D.F. (tanδ)	≤300% of the initial specified value					
	Leakage current	≤The initial specified value					
Shelf Life	The following specifications shall be satisfied when the capacitors are restored to 20°C after exposing them for 500 hours at 105°C without voltage applied. Before the measurement, the capacitor shall be preconditioned by applying voltage according to Item 4.1 of JIS C 5101-4.						
	Capacitance change	≤±25% of the initial value					
	D.F. (tanδ)	≤200% of the initial specified value					
	Leakage current	≤The initial specified value					

◆DIMENSIONS [mm]

●Terminal Code : A

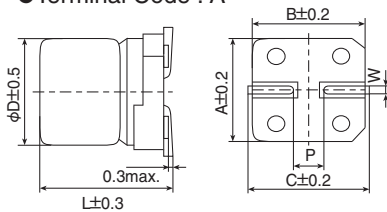

Size code	D	L	A	B	C	W	P
D60	4	5.7	4.3	4.3	5.1	0.5 to 0.8	1.0
E60	5	5.7	5.3	5.3	5.9	0.5 to 0.8	1.4
F60	6.3	5.7	6.6	6.6	7.2	0.5 to 0.8	1.9

◆PART NUMBERING SYSTEM

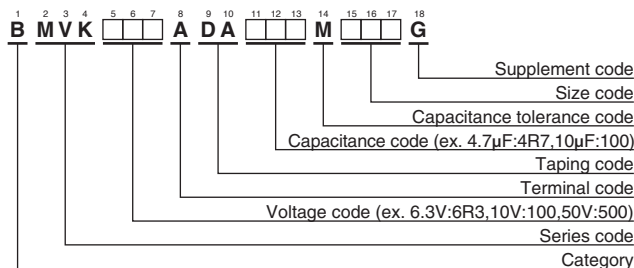

Please refer to "Product code guide (surface mount type)"

◆MARKING

EX) 35V4.7μF



◆STANDARD RATINGS

WV (V _{dc})	Cap (μF)	Size code	tanδ	Rated ripple current (mArms/105°C, 120Hz)	Part No.
6.3	10	D60	0.35	14	BMVK6R3ADA100MD60G
	22	E60	0.35	25	BMVK6R3ADA220ME60G
	47	F60	0.35	39	BMVK6R3ADA470MF60G
10	33	F60	0.26	35	BMVK100ADA330MF60G
	4.7	D60	0.24	12	BMVK160ADA4R7MD60G
16	10	E60	0.24	20	BMVK160ADA100ME60G
	22	F60	0.24	32	BMVK160ADA220MF60G
	3.3	D60	0.20	10	BMVK250ADA3R3MD60G
25	2.2	D60	0.18	8.8	BMVK350ADA2R2MD60G
	4.7	E60	0.18	15	BMVK350ADA4R7ME60G
	10	F60	0.18	23	BMVK350ADA100MF60G
35	1.0	D60	0.18	5.5	BMVK500ADA1R0MD60G
	2.2	E60	0.18	10	BMVK500ADA2R2ME60G
	3.3	E60	0.18	13	BMVK500ADA3R3ME60G
	4.7	F60	0.18	16	BMVK500ADA4R7MF60G

RECOMMENDED REFLOW SOLDERING CONDITIONS

Alchip™ MVA/MVE/MZJ/MZA/MVY/MZF/MZE/MZK/MLA/MLF/MLK/MLV/MVJ/MVH/MHB/MHJ/MKB/MV-BP/MVK-BP

The following conditions are recommended for air convection and infrared reflow soldering on the SMD products on to a glass epoxy circuit boards by cream solder. The dimensions of the glass epoxy boards with resist are 90×50×0.8mm for D55 to KG5 case code SMD capacitors and 180×90×0.8mm for LH0 to MNO case codes SMD capacitors.

The temperatures shown are the surface temperature values on the top of the can and on the capacitor terminals.

Reflow should be performed twice or less.

Please ensure that the capacitor became cold enough to the room temperature (5 to 35°C) before the second reflow.

Consult with us when performing reflow profile in IPC / JEDEC (J-STD-020)

●Recommended soldering heat conditions (Except for Conductive Polymer Aluminum Solid Capacitors)

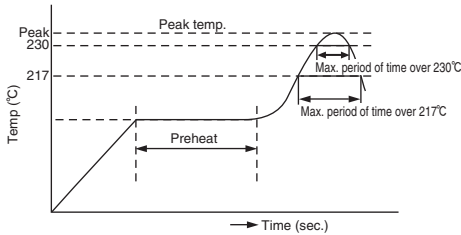

SMD type	Size code	Voltage range (V _{dc})	Preheat	Time maintained above 217°C	Time maintained above 230°C	Peak temp.	Reflow number
Vertical	D55 to F90	4 to 63V (Except 63V for MVH)	150 to 180°C 120sec. max.	90sec. max.	60sec. max.	260°Cmax.	2 times or less
		63V(MVH), 80V		60sec. max.	40sec. max.	250°Cmax.	2 times or less
	H63 to JA0	4 to 50V		60sec. max.	30sec. max.	245°Cmax.	2 times or less
		63 to 100, 400V		30sec. max.	20sec. max.	240°Cmax.	2 times or less
	KE0 to MNO	6.3 to 50V		30sec. max.	20sec. max.	240°Cmax.	2 times or less
		63 to 450V		20sec. max.	—	230°Cmax.	2 times or less

●Recommended Solder Land on PC Board

Series : MVA/MVE/MZJ/MZA/MVY/MZF/MZE/MZK/MLA/MLF/MLK/MLV/MVJ/MVH/MHB/MHJ/MKB/MV-BP/MVK-BP

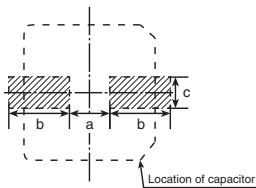

: Solder land on PC board

Size code	Terminal code : A			Terminal code : G		
	a	b	c	a	b	c
D55, D60, D61, D73	1.0	2.6	1.6			
E55, E60, E61, E73	1.4	3.0	1.6			
F55, F60, F61, F73, F80, F90	1.9	3.5	1.6			
H63	2.3	4.5	1.6			
HA0	3.1	4.2	2.2	3.1	4.2	3.5
JA0	4.5	4.4	2.2	4.5	4.4	3.5
KE0, KG5	4.0	5.7	2.5	3.4	6.3	9.3
LH0, LN0	6.0	6.9	2.5	4.7	7.8	9.6
MH0, MNO	6.0	7.9	2.5	4.7	8.8	9.6

◆PRECAUTIONS FOR USERS

Soldering method

The capacitors of Alchip-series have no capability to withstand such dip or wave soldering as totally immerses components into a solder bath.

Reflow soldering

Reflow the capacitors within recommended reflow soldering conditions. Verify there is no temperature stress to the capacitors because the following differences might degrade capacitors electrically and mechanically. Please consult us if other reflow conditions are employed.

1. Location of components : Temperature increases at the edge of PC board more than the center.
2. Population of PC board : The lower the component population is, the more temperature rises.
3. Material of PC board : A ceramic made board needs more heat than a glass epoxy made board. The heat increase may cause damage to the capacitors.
4. Thickness of PC board : A thicker board needs more heat than a thinner board. The heat increase may damage the capacitors.
5. Size of PC board : A larger board needs more heat than a smaller board. The heat increase may damage the capacitors.
6. Solder thickness
If very thin cream solder paste is to be used for SMD types, please consult with us.
7. Location of infrared ray lamps : IR reflow as well as hot plate reflow heats only on the reverse side of the PC board to lessen heat stress to the capacitors.
8. Vapor phase soldering (VPS) is not used.

Rework of soldering

Use a soldering iron for rework. Do not exceed an iron tip temperature of 380±10°C and an exposure time of 3±0.5 seconds.

Mechanical stress

Do not use the capacitors for lifting the PC board and give stress to the capacitor. Avoid bending the PC board. This may damage the capacitors.

Cleaning assembly board

Immediately after solvent cleaning, remove residual solvent with an air knife for at least 10 minutes. If the solvent is insufficiently dry, the capacitors may corrode.

Coating on assembly board

1. Before curing coating material, remove the cleaning solvents from the assembly board.
2. Before conformal coating, a chloride free pre-coat material is recommended to decrease the stress on the capacitors.

Molding with resin

Internal chemical reaction gradually produces gas in the capacitor; then, increasing internal pressure. If the end seal of the capacitor is completely covered by resin the gas will be unable to escape causing a potentially dangerous situation. The chlorine contained resin will penetrate into the end seal, reach the inside element, and cause damage of the capacitor.

Others

Refer to PRECAUTIONS AND GUIDELINES.

Miniature Aluminum Electrolytic Capacitors

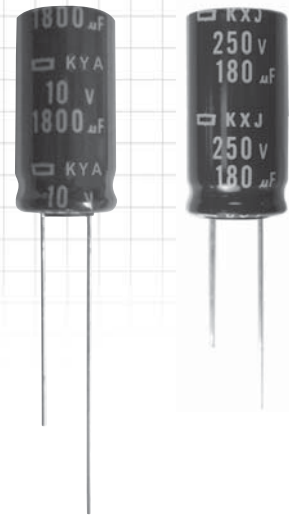

Product code guide (Radial lead type)

(Example : KMQ series, 450V-100 μ F, ϕ 18 \times 40L, Long lead with bulk)



Please refer to the following table

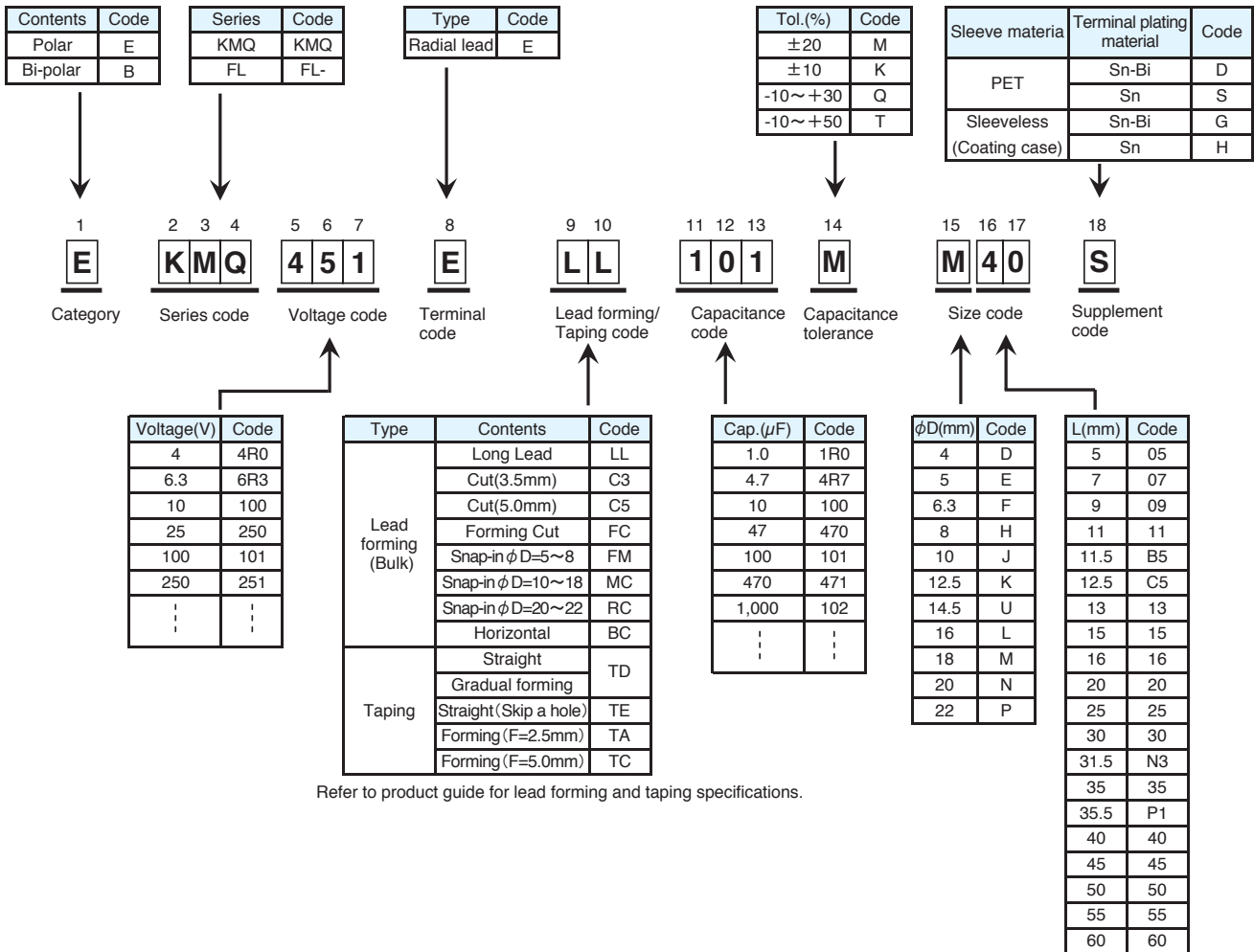

Refer to product guide for lead forming and taping specifications.

*Refer to the appendix (Part number) for codes not listed here.

SRM Series

- Downsized from current standard SRE series
- 5mm height
- Endurance : 1,000 hours at 85°C
- Solvent resistant type (see PRECAUTIONS AND GUIDELINES)
- RoHS Compliant

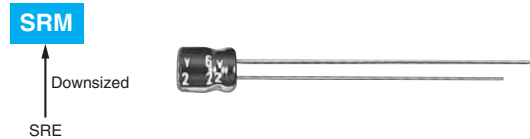

◆ SPECIFICATIONS

Items	Characteristics								
Category	-40 to +85°C								
Temperature Range									
Rated Voltage Range	4 to 50V _{dc}								
Capacitance Tolerance	±20% (M) (at 20°C, 120Hz)								
Leakage Current	I=0.01CV or 3μA, whichever is greater. Where, I : Max. leakage current (μA), C : Nominal capacitance (μF), V : Rated voltage (V) (at 20°C after 2 minutes)								
Dissipation Factor (tanδ)	Rated voltage (V _{dc})	4V	6.3V	10V	16V	25V	35V	50V	
	tanδ (Max.)	0.40	0.38	0.30	0.23	0.17	0.15	0.13	(at 20°C, 120Hz)
Low Temperature Characteristics (Max. Impedance Ratio)	Rated voltage (V _{dc})	4V	6.3V	10V	16V	25V	35V	50V	
	Z(-25°C)/Z(+20°C)	7	4	3	2	2	2	2	
	Z(-40°C)/Z(+20°C)	15	8	8	6	4	3	3	(at 120Hz)
Endurance	The following specifications shall be satisfied when the capacitors are restored to 20°C after the rated voltage is applied for 1,000 hours at 85°C.								
	Capacitance change	≤±20% of the initial value							
	D.F. (tanδ)	≤200% of the initial specified value							
	Leakage current	≤The initial specified value							
Shelf Life	The following specifications shall be satisfied when the capacitors are restored to 20°C after exposing them for 1,000 hours at 85°C without voltage applied. Before the measurement, the capacitor shall be preconditioned by applying voltage according to Item 4.1 of JIS C 5101-4.								
	Capacitance change	≤±20% of the initial value							
	D.F. (tanδ)	≤200% of the initial specified value							
	Leakage current	≤The initial specified value							

◆ DIMENSIONS [mm]

- Terminal Code : E

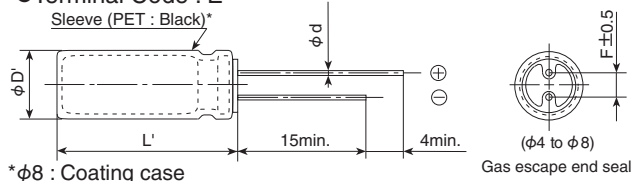

φD	4	5	6.3	8
φd	0.45	0.45	0.45	0.45
F	1.5	2.0	2.5	2.5
φD'	φD+0.5max.			
L'	L+1.0max.			

*φ8 : Coating case

◆ PART NUMBERING SYSTEM

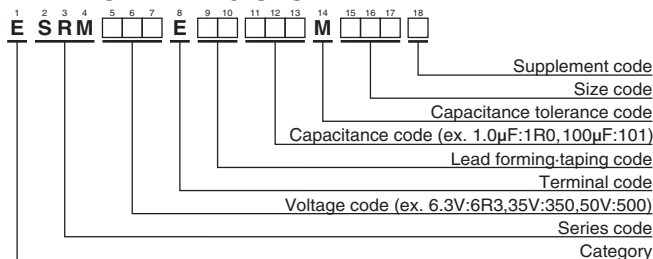

Please refer to "Product code guide (radial lead type)"

◆ STANDARD RATINGS

WV (V _{dc})	Cap (μF)	Case size φD×L(mm)	tanδ	Rated ripple current (mA _{rms} /85°C,120Hz)	Part No.
4	100	5×5	0.40	55	ESRM4R0E□□101ME05D
	220	6.3×5	0.40	88	ESRM4R0E□□221MF05D
6.3	22	4×5	0.38	22	ESRM6R3E□□220MD05D
	47	4×5	0.38	40	ESRM6R3E□□470MD05D
	330	8×5	0.38	141	ESRM6R3E□□331MH05G
10	33	4×5	0.30	36	ESRM100E□□101MF05D
	100	6.3×5	0.30	78	ESRM100E□□221MF05D
	220	8×5	0.30	148	ESRM100E□□221MH05G
16	10	4×5	0.23	18	ESRM160E□□100MD05D
	22	4×5	0.23	33	ESRM160E□□220MD05D
	33	5×5	0.23	47	ESRM160E□□330ME05D
	47	5×5	0.23	55	ESRM160E□□470ME05D
25	4.7	4×5	0.17	13	ESRM250E□□4R7MD05D
	10	4×5	0.17	25	ESRM250E□□100MD05D
25	22	5×5	0.17	41	ESRM250E□□220ME05D
	47	6.3×5	0.17	63	ESRM250E□□470MF05D
	100	8×5	0.17	116	ESRM250E□□101MH05G
35	3.3	4×5	0.15	12	ESRM350E□□3R3MD05D
	33	6.3×5	0.15	56	ESRM350E□□330MF05D
	47	8×5	0.15	85	ESRM350E□□470MH05G
50	1.0	4×5	0.13	7.2	ESRM500E□□1R0MD05D
	2.2	4×5	0.13	10	ESRM500E□□2R2MD05D
	3.3	4×5	0.13	14	ESRM500E□□3R3MD05D
	4.7	4×5	0.13	19	ESRM500E□□4R7MD05D
	10	5×5	0.13	31	ESRM500E□□100ME05D
	22	6.3×5	0.13	49	ESRM500E□□220MF05D
	33	8×5	0.13	76	ESRM500E□□330MH05G

□□ : Enter the appropriate lead forming or taping code.

SRE Series

- 5mm height
- Endurance : 1,000 hours at 85°C
- Non solvent resistant type
- RoHS Compliant



SPECIFICATIONS

Items	Characteristics								
Category	-40 to +85°C								
Temperature Range									
Rated Voltage Range	4 to 50V _{dc}								
Capacitance Tolerance	±20% (M) (at 20°C, 120Hz)								
Leakage Current	I=0.01CV or 3μA, whichever is greater. Where, I : Max. leakage current (μA), C : Nominal capacitance (μF), V : Rated voltage (V) (at 20°C after 2 minutes)								
Dissipation Factor (tanδ)	Rated voltage (V _{dc})	4V	6.3V	10V	16V	25V	35V	50V	(at 20°C, 120Hz)
	tanδ (Max.)	0.35	0.24	0.20	0.16	0.14	0.12	0.10	
Low Temperature Characteristics (Max. Impedance Ratio)	Rated voltage (V _{dc})	4V	6.3V	10V	16V	25V	35V	50V	(at 120Hz)
	Z(-25°C)/Z(+20°C)	7	4	3	2	2	2	2	
	Z(-40°C)/Z(+20°C)	15	10	8	6	4	3	3	
Endurance	The following specifications shall be satisfied when the capacitors are restored to 20°C after the rated voltage is applied for 1,000 hours at 85°C.								
	Capacitance change	≤±20% of the initial value							
	D.F. (tanδ)	≤200% of the initial specified value							
	Leakage current	≤The initial specified value							
Shelf Life	The following specifications shall be satisfied when the capacitors are restored to 20°C after exposing them for 1,000 hours at 85°C without voltage applied. Before the measurement, the capacitor shall be preconditioned by applying voltage according to Item 4.1 of JIS C 5101-4.								
	Capacitance change	≤±20% of the initial value							
	D.F. (tanδ)	≤200% of the initial specified value							
	Leakage current	≤The initial specified value							

DIMENSIONS [mm]

Terminal Code : E

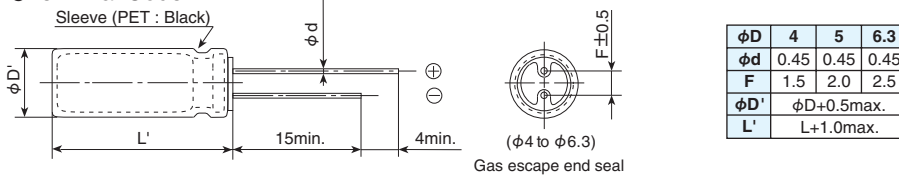

PART NUMBERING SYSTEM

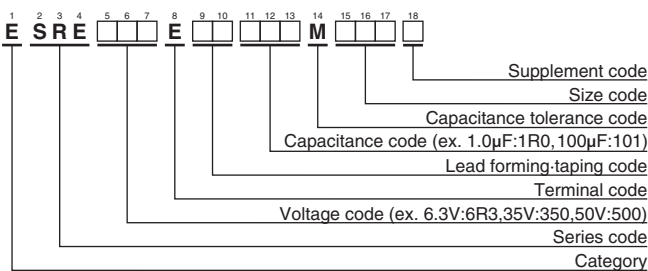

Please refer to "Product code guide (radial lead type)"

STANDARD RATINGS

WV (V _{dc})	Cap (μF)	Case size φD×L(mm)	tanδ	Rated ripple current (mA _{rms} /85°C,120Hz)	Part No.
4	33	4×5	0.35	23	ESRE4R0E□□330MD05D
	10	4×5	0.24	12	ESRE6R3E□□100MD05D
6.3	22	4×5	0.24	23	ESRE6R3E□□220MD05D
	47	5×5	0.24	38	ESRE6R3E□□470ME05D
	100	6.3×5	0.24	60	ESRE6R3E□□101MF05D
	33	5×5	0.20	35	ESRE100E□□330ME05D
10	4.7	4×5	0.16	10	ESRE160E□□4R7MD05D
	10	4×5	0.16	17	ESRE160E□□100MD05D
	22	5×5	0.16	32	ESRE160E□□220ME05D
	47	6.3×5	0.16	50	ESRE160E□□470MF05D
	3.3	4×5	0.14	9.3	ESRE250E□□3R3MD05D
16	4.7	4×5	0.14	12	ESRE250E□□4R7MD05D
	33	6.3×5	0.14	45	ESRE250E□□330MF05D
	2.2	4×5	0.12	8.3	ESRE350E□□2R2MD05D
35	3.3	4×5	0.12	11	ESRE350E□□3R3MD05D
	4.7	4×5	0.12	15	ESRE350E□□4R7MD05D
	10	5×5	0.12	25	ESRE350E□□100ME05D
	22	6.3×5	0.12	40	ESRE350E□□220MF05D
	1.0	4×5	0.10	6.2	ESRE500E□□1R0MD05D
50	2.2	4×5	0.10	10	ESRE500E□□2R2MD05D
	3.3	4×5	0.10	14	ESRE500E□□3R3MD05D
	4.7	5×5	0.10	19	ESRE500E□□4R7ME05D
	10	6.3×5	0.10	29	ESRE500E□□100MF05D

□□ : Enter the appropriate lead forming or taping code.

KRE Series

- 5mm height
- Endurance : 1,000 hours at 105°C
- Solvent resistant type (see PRECAUTIONS AND GUIDELINES)
- RoHS Compliant

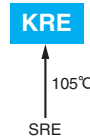

◆ SPECIFICATIONS

Items	Characteristics						
Category Temperature Range	-55 to +105°C						
Rated Voltage Range	6.3 to 50V _{dc}						
Capacitance Tolerance	±20% (M) (at 20°C, 120Hz)						
Leakage Current	I=0.01CV or 3μA, whichever is greater. Where, I : Max. leakage current (μA), C : Nominal capacitance (μF), V : Rated voltage (V) (at 20°C after 2 minutes)						
Dissipation Factor (tanδ)	Rated voltage (V _{dc})	6.3V	10V	16V	25V	35V	50V
	tan δ (Max.)	0.27	0.23	0.19	0.15	0.13	0.11
Low Temperature Characteristics (Max. Impedance Ratio)	Rated voltage (V _{dc})	6.3V	10V	16V	25V	35V	50V
	Z(-25°C)/Z(+20°C)	3	3	2	2	2	2
	Z(-40°C)/Z(+20°C)	9	7	5	3	3	3
Endurance	The following specifications shall be satisfied when the capacitors are restored to 20°C after the rated voltage is applied for 1,000 hours at 105°C.						
	Capacitance change	≤±20% of the initial value					
	D.F. (tanδ)	≤200% of the initial specified value					
	Leakage current	≤The initial specified value					
Shelf Life	The following specifications shall be satisfied when the capacitors are restored to 20°C after exposing them for 500 hours at 105°C without voltage applied. Before the measurement, the capacitor shall be preconditioned by applying voltage according to Item 4.1 of JIS C 5101-4.						
	Capacitance change	≤±20% of the initial value					
	D.F. (tanδ)	≤200% of the initial specified value					
	Leakage current	≤The initial specified value					

◆ DIMENSIONS [mm]

- Terminal Code : E

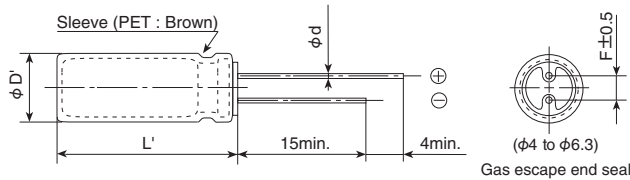

φD	4	5	6.3
φd	0.45	0.45	0.45
F	1.5	2.0	2.5
φD'	φD+0.5max.		
L'	L+1.0max.		

◆ PART NUMBERING SYSTEM

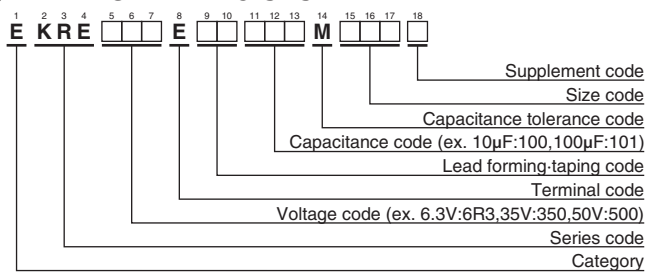

Please refer to "Product code guide (radial lead type)"

◆ STANDARD RATINGS

WV (V _{dc})	Cap (μF)	Case size φD×L(mm)	tanδ	Rated ripple current (mArms/105°C, 120Hz)	Part No.
6.3	10	4×5	0.27	12	EKRE6R3E□□100MD05D
	22	4×5	0.27	21	EKRE6R3E□□220MD05D
	47	5×5	0.27	36	EKRE6R3E□□470ME05D
	100	6.3×5	0.27	56	EKRE6R3E□□101MF05D
10	33	5×5	0.23	34	EKRE100E□□330ME05D
16	4.7	4×5	0.19	9.4	EKRE160E□□4R7MD05D
	10	4×5	0.19	16	EKRE160E□□100MD05D
	22	5×5	0.19	30	EKRE160E□□220ME05D
	47	6.3×5	0.19	48	EKRE160E□□470MF05D
25	3.3	4×5	0.15	8.8	EKRE250E□□3R3MD05D
	4.7	4×5	0.15	12	EKRE250E□□4R7MD05D
	33	6.3×5	0.15	45	EKRE250E□□330MF05D
35	2.2	4×5	0.13	7.7	EKRE350E□□2R2MD05D
	3.3	4×5	0.13	11	EKRE350E□□3R3MD05D
	4.7	4×5	0.13	15	EKRE350E□□4R7MD05D
	10	5×5	0.13	25	EKRE350E□□100ME05D
	22	6.3×5	0.13	40	EKRE350E□□220MF05D
50	1.0	4×5	0.11	5.6	EKRE500E□□1R0MD05D
	2.2	4×5	0.11	10	EKRE500E□□2R2MD05D
	3.3	4×5	0.11	14	EKRE500E□□3R3MD05D
	4.7	5×5	0.11	19	EKRE500E□□4R7ME05D
	10	6.3×5	0.11	29	EKRE500E□□100MF05D

□□ : Enter the appropriate lead forming or taping code.

SRA Series

- 7mm height
- Endurance : 1,000 hours at 85°C
- Non solvent resistant type
- RoHS Compliant

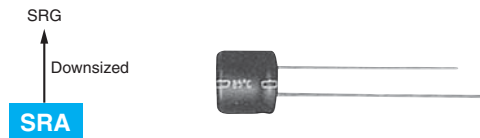

◆ SPECIFICATIONS

Items	Characteristics								
Category	-40 to +85°C								
Temperature Range	-40 to +85°C								
Rated Voltage Range	4 to 63V _{dc}								
Capacitance Tolerance	±20% (M) (at 20°C, 120Hz)								
Leakage Current	I=0.01CV or 3μA, whichever is greater. Where, I : Max. leakage current (μA), C : Nominal capacitance (μF), V : Rated voltage (V) (at 20°C after 2 minutes)								
Dissipation Factor (tanδ)	Rated voltage (V _{dc})	4V	6.3V	10V	16V	25V	35V	50V	63V
	tanδ (Max.)	0.35	0.24	0.20	0.16	0.14	0.12	0.10	0.08
Low Temperature Characteristics (Max. Impedance Ratio)	Rated voltage (V _{dc})	4V	6.3V	10V	16V	25V	35V	50V	63V
	Z(-25°C)/Z(+20°C)	4	4	3	2	2	2	2	2
	Z(-40°C)/Z(+20°C)	10	10	8	6	4	3	3	3
Endurance	The following specifications shall be satisfied when the capacitors are restored to 20°C after the rated voltage is applied for 1,000 hours at 85°C.								
	Capacitance change	≤±20% of the initial value							
	D.F. (tanδ)	≤200% of the initial specified value							
	Leakage current	≤The initial specified value							
Shelf Life	The following specifications shall be satisfied when the capacitors are restored to 20°C after exposing them for 500 hours at 85°C without voltage applied. Before the measurement, the capacitor shall be preconditioned by applying voltage according to Item 4.1 of JIS C 5101-4.								
	Capacitance change	≤±20% of the initial value							
	D.F. (tanδ)	≤200% of the initial specified value							
	Leakage current	≤The initial specified value							

◆ DIMENSIONS [mm]

- Terminal Code : E

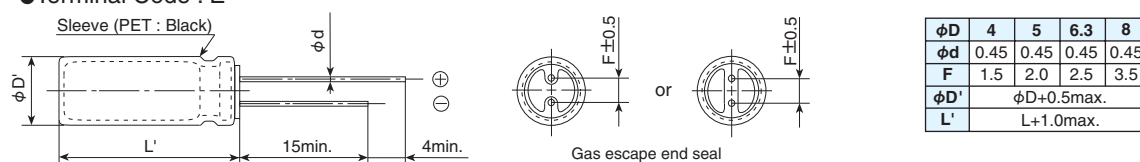

◆ PART NUMBERING SYSTEM

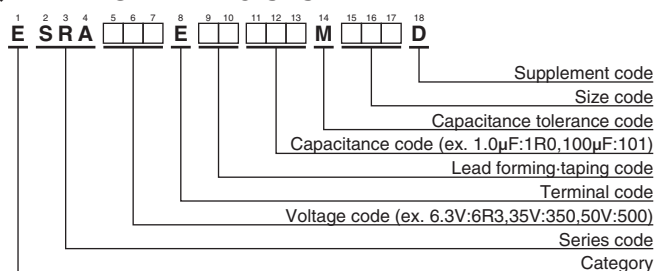

Please refer to "Product code guide (radial lead type)"

◆ STANDARD RATINGS

VV (V _{dc})	Cap (μF)	Case size φD×L(mm)	tanδ	Rated ripple current (mArms/85°C,120Hz)	Part No.
4	33	4×7	0.35	26	ESRA4R0E□□330MD07D
	47	4×7	0.35	34	ESRA4R0E□□470MD07D
	100	5×7	0.35	61	ESRA4R0E□□101ME07D
	220	6.3×7	0.35	95	ESRA4R0E□□221MF07D
	470	8×7	0.35	154	ESRA4R0E□□471MH07D
6.3	22	4×7	0.24	31	ESRA6R3E□□220MD07D
	47	5×7	0.24	47	ESRA6R3E□□470ME07D
	330	8×7	0.24	156	ESRA6R3E□□331MH07D
10	33	5×7	0.20	43	ESRA100E□□330ME07D
	100	6.3×7	0.20	80	ESRA100E□□101MF07D
	220	8×7	0.20	140	ESRA100E□□221MH07D
16	10	4×7	0.16	25	ESRA160E□□100MD07D
	22	5×7	0.16	39	ESRA160E□□220ME07D
	47	6.3×7	0.16	59	ESRA160E□□470MF07D
	100	6.3×7	0.16	97	ESRA160E□□101MF07D
25	33	6.3×7	0.14	53	ESRA250E□□330MF07D
	47	6.3×7	0.14	71	ESRA250E□□470MF07D
35	4.7	4×7	0.12	20	ESRA350E□□4R7MD07D
	10	5×7	0.12	30	ESRA350E□□100ME07D
	22	6.3×7	0.12	47	ESRA350E□□220MF07D
	33	6.3×7	0.12	64	ESRA350E□□330MF07D
	47	8×7	0.12	83	ESRA350E□□470MH07D
50	1.0	4×7	0.10	10	ESRA500E□□1R0MD07D
	2.2	4×7	0.10	15	ESRA500E□□2R2MD07D
	3.3	4×7	0.10	18	ESRA500E□□3R3MD07D
	4.7	5×7	0.10	23	ESRA500E□□4R7ME07D
	10	6.3×7	0.10	34	ESRA500E□□100MF07D
	22	6.3×7	0.10	57	ESRA500E□□220MF07D
63	33	8×7	0.10	76	ESRA500E□□330MH07D
	1.0	4×7	0.08	11	ESRA630E□□1R0MD07D
	2.2	4×7	0.08	17	ESRA630E□□2R2MD07D
	3.3	5×7	0.08	21	ESRA630E□□3R3ME07D
	4.7	6.3×7	0.08	26	ESRA630E□□4R7MF07D
10	6.3×7	0.08	47	ESRA630E□□100MF07D	

□□ : Enter the appropriate lead forming or taping code.

KMA Series

- 7mm height
- Endurance : 1,000 hours at 105°C
- Solvent resistant type (see PRECAUTIONS AND GUIDELINES)
- RoHS Compliant

KMA

105°C
SRA



◆SPECIFICATIONS

Items	Characteristics										
Category	-55 to +105°C										
Temperature Range	-55 to +105°C										
Rated Voltage Range	4 to 63V _{dc}										
Capacitance Tolerance	±20% (M) (at 20°C, 120Hz)										
Leakage Current	I=0.01CV or 3μA, whichever is greater. (at 20°C, 120Hz) Where, I : Max. leakage current (μA), C : Nominal capacitance (μF), V : Rated voltage (V) (at 20°C after 2 minutes)										
Dissipation Factor (tanδ)	Rated voltage (V _{dc})	4V	6.3V	10V	16V	25V	35V	50V	63V		
	tanδ (Max.)	0.35	0.22	0.19	0.16	0.14	0.12	0.10	0.08	(at 20°C, 120Hz)	
Low Temperature Characteristics (Max. Impedance Ratio)	Rated voltage (V _{dc})	4V	6.3V	10V	16V	25V	35V	50V	63V		
	Z(-25°C)/Z(+20°C)	4	3	2	2	2	2	2	2	(at 120Hz)	
	Z(-40°C)/Z(+20°C)	10	6	5	3	3	3	3	3	(at 120Hz)	
Endurance	The following specifications shall be satisfied when the capacitors are restored to 20°C after the rated voltage is applied for 1,000 hours at 105°C.										
	Rated voltage	4 to 16V _{dc}				25 to 63V _{dc}					
	Capacitance change	≤±25% of the initial value				≤±20% of the initial value					
	D.F. (tanδ)	≤200% of the initial specified value									
	Leakage current	≤The initial specified value									
Shelf Life	The following specifications shall be satisfied when the capacitors are restored to 20°C after exposing them for 1,000 hours at 105°C without voltage applied. Before the measurement, the capacitor shall be preconditioned by applying voltage according to Item 4.1 of JIS C 5101-4.										
	Rated voltage	4 to 16V _{dc}				25 to 63V _{dc}					
	Capacitance change	≤±25% of the initial value				≤±20% of the initial value					
	D.F. (tanδ)	≤200% of the initial specified value									
	Leakage current	≤The initial specified value									

◆DIMENSIONS [mm]

●Terminal Code : E

Sleeve (PET : Brown)

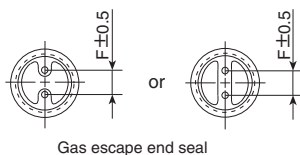
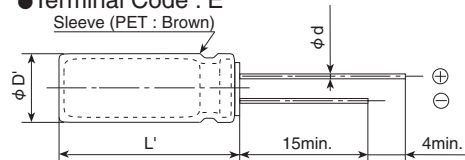

φD	4	5	6.3
φd	0.45	0.45	0.45
F	1.5	2.0	2.5
φD'	φD+0.5max.		
L'	L+1.0max.		

◆PART NUMBERING SYSTEM

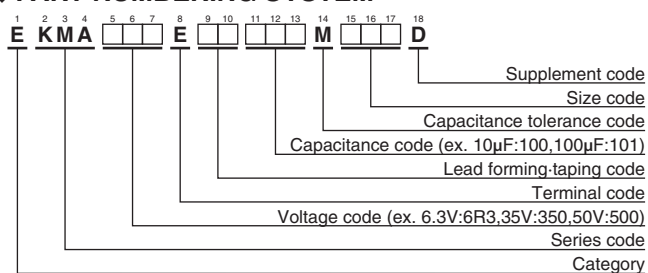

Please refer to "Product code guide (radial lead type)"

◆ STANDARD RATINGS

WV (V _{dc})	Cap (μF)	Case size φD×L(mm)	tanδ	Rated ripple current (mA _{rms} /105°C, 120Hz)	Part No.	WV (V _{dc})	Cap (μF)	Case size φD×L(mm)	tanδ	Rated ripple current (mA _{rms} /105°C, 120Hz)	Part No.
4	33	4×7	0.35	26	EKMA4R0E□□330MD07D	35	4.7	4×7	0.12	20	EKMA350E□□4R7MD07D
	47	4×7	0.35	34	EKMA4R0E□□470MD07D		10	5×7	0.12	30	EKMA350E□□100ME07D
	100	5×7	0.35	61	EKMA4R0E□□101ME07D		22	6.3×7	0.12	47	EKMA350E□□220MF07D
	220	6.3×7	0.35	95	EKMA4R0E□□221MF07D		33	6.3×7	0.12	64	EKMA350E□□330MF07D
6.3	22	4×7	0.22	31	EKMA6R3E□□220MD07D	50	1.0	4×7	0.10	10	EKMA500E□□1R0MD07D
	47	5×7	0.22	47	EKMA6R3E□□470ME07D		2.2	4×7	0.10	15	EKMA500E□□2R2MD07D
10	33	5×7	0.19	43	EKMA100E□□330ME07D		3.3	4×7	0.10	18	EKMA500E□□3R3MD07D
	100	6.3×7	0.19	80	EKMA100E□□101MF07D		4.7	5×7	0.10	23	EKMA500E□□4R7ME07D
16	10	4×7	0.16	25	EKMA160E□□100MD07D		10	6.3×7	0.10	34	EKMA500E□□100MF07D
	22	5×7	0.16	39	EKMA160E□□220ME07D		22	6.3×7	0.10	57	EKMA500E□□220MF07D
	47	6.3×7	0.16	59	EKMA160E□□470MF07D	63	1.0	4×7	0.08	11	EKMA630E□□1R0MD07D
	100	6.3×7	0.16	97	EKMA160E□□101MF07D		2.2	4×7	0.08	17	EKMA630E□□2R2MD07D
25	33	6.3×7	0.14	53	EKMA250E□□330MF07D		3.3	5×7	0.08	21	EKMA630E□□3R3ME07D
	47	6.3×7	0.14	71	EKMA250E□□470MF07D		4.7	6.3×7	0.08	26	EKMA630E□□4R7MF07D
						10	6.3×7	0.08	43	EKMA630E□□100MF07D	

□□ : Enter the appropriate lead forming or taping code.

SRG Series

- Low profile : $\phi 4 \times 7\text{mm}$ to $\phi 18 \times 25\text{mm}$
- Endurance : 1,000 to 2,000 hours at 85°C
- Solvent resistant type (see PRECAUTIONS AND GUIDELINES)
- RoHS Compliant

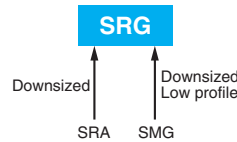

◆ SPECIFICATIONS

Items	Characteristics	
Category Temperature Range	-40 to +85°C	
Rated Voltage Range	4 to 50V _{dc}	
Capacitance Tolerance	±20% (M) (at 20°C, 120Hz)	
Leakage Current	I=0.01CV or 3μA, whichever is greater. Where, I : Max. leakage current (μA), C : Nominal capacitance (μF), V : Rated voltage (V) (at 20°C after 2 minutes)	
Dissipation Factor (tanδ)	Rated voltage (V _{dc})	4V 6.3V 10V 16V 25V 35V 50V
	tanδ (Max.)	0.38 0.28 0.24 0.20 0.16 0.14 0.12
	When nominal capacitance exceeds 1,000μF, add 0.03 to the value above for each 1,000μF increase. (at 20°C, 120Hz)	
Low Temperature Characteristics (Max. Impedance Ratio)	Rated voltage (V _{dc})	4V 6.3V 10V 16V 25V 35V 50V
	Z(-25°C)/Z(+20°C)	6 5 4 3 2 2 2
	Z(-40°C)/Z(+20°C)	12 12 10 8 5 4 3 (at 120Hz)
Endurance	The following specifications shall be satisfied when the capacitors are restored to 20°C after the rated voltage is applied for 2,000 hours (1,000 hours for $\phi 8$ and smaller) at 85°C.	
	Capacitance change	≤±20% of the initial value
	D.F. (tanδ)	≤200% of the initial specified value
	Leakage current	≤The initial specified value
Shelf Life	The following specifications shall be satisfied when the capacitors are restored to 20°C after exposing them for 1,000 hours at 85°C without voltage applied. Before the measurement, the capacitor shall be preconditioned by applying voltage according to Item 4.1 of JIS C 5101-4.	
	Capacitance change	≤±20% of the initial value
	D.F. (tanδ)	≤200% of the initial specified value
	Leakage current	≤The initial specified value

◆ DIMENSIONS [mm]

- Terminal Code : E

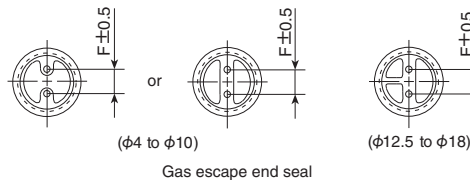
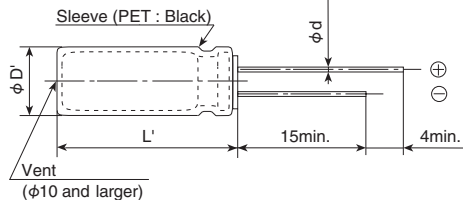

φD	4	5	6.3	8	10 & 12.5	16 & 18
7L	0.45	0.45	0.45	0.45	—	—
φd	≥9L	—	0.5	0.5	0.6	0.6
F	1.5	2.0	2.5	3.5	5.0	7.5
φD'	φD+0.5max.					
L'	L+1.5max. (7L : L+1.0max.)					

◆ PART NUMBERING SYSTEM

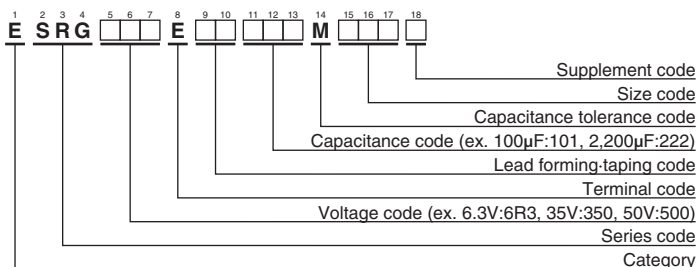

Please refer to "Product code guide (radial lead type)"

◆STANDARD RATINGS

WV (Vdc)	Cap (μF)	Case code φD×L(mm)	tan δ	Rated ripple current (mA rms/85°C, 120Hz)	Part No.	WV (Vdc)	Cap (μF)	Case code φD×L(mm)	tan δ	Rated ripple current (mA rms/85°C, 120Hz)	Part No.
4	470	8×7	0.38	154	ESRG4R0E□□471MH07D	25	470	10×12.5	0.16	525	ESRG250E□□471MJC5S
	47	4×7	0.28	50	ESRG6R3E□□470MD07D		1,000	12.5×15	0.16	830	ESRG250E□□102MK15S
6.3	100	5×7	0.28	87	ESRG6R3E□□101ME07D	2,200	18×15	0.19	1,360	ESRG250E□□222MM15S	
	220	6.3×7	0.28	133	ESRG6R3E□□221MF07D	3,300	18×20	0.22	1,720	ESRG250E□□332MM20S	
	330	6.3×9	0.28	247	ESRG6R3E□□331MF09D	4,700	18×25	0.25	2,070	ESRG250E□□472MM25S	
	330	8×7	0.28	191	ESRG6R3E□□331MH07D	35	10	4×7	0.14	32	ESRG350E□□100MD07D
	1,000	10×9	0.28	505	ESRG6R3E□□330MD07D		22	5×7	0.14	57	ESRG350E□□101MH09D
	4,700	16×15	0.37	1,410	ESRG6R3E□□472ML15S		33	5×9	0.14	94	ESRG350E□□330ME09D
	6,800	18×15	0.43	1,660	ESRG6R3E□□682MM15S		33	6.3×7	0.14	73	ESRG350E□□330MF07D
	10,000	18×20	0.55	2,020	ESRG6R3E□□103MM20S		47	8×7	0.14	101	ESRG350E□□470MH07D
10	33	4×7	0.24	46	ESRG100E□□330MD07D		100	8×9	0.14	220	ESRG350E□□101MH09D
	100	5×9	0.24	132	ESRG100E□□101ME09D		220	10×9	0.14	335	ESRG350E□□221MJ09S
	220	6.3×9	0.24	218	ESRG100E□□221MF09D		330	10×12.5	0.14	475	ESRG350E□□331MJC5S
	220	8×7	0.24	171	ESRG100E□□221MH07D	470	12.5×13	0.14	585	ESRG350E□□471MK13S	
	470	8×9	0.24	385	ESRG100E□□471MH09D	1,000	16×15	0.14	1,010	ESRG350E□□102ML15S	
	1,000	10×12.5	0.24	625	ESRG100E□□102MJC5S	2,200	18×20	0.17	1,560	ESRG350E□□222MM20S	
	2,200	12.5×15	0.27	970	ESRG100E□□222MK15S	50	1.0	4×7	0.12	10	ESRG500E□□1R0MD07D
	3,300	16×15	0.30	1,310	ESRG100E□□332ML15S		1.0	5×9	0.12	13	ESRG500E□□1R0ME09D
	4,700	18×15	0.33	1,560	ESRG100E□□472MM15S		2.2	4×7	0.12	15	ESRG500E□□2R2MD07D
	6,800	18×20	0.39	1,870	ESRG100E□□682MM20S		2.2	5×9	0.12	26	ESRG500E□□2R2ME09D
10,000	18×25	0.51	2,370	ESRG100E□□103MM25S	3.3		4×7	0.12	19	ESRG500E□□3R3MD07D	
16	22	4×7	0.20	42	ESRG160E□□220MD07D		3.3	5×9	0.12	32	ESRG500E□□3R3ME09D
	47	5×7	0.20	73	ESRG160E□□470ME07D		4.7	4×7	0.12	24	ESRG500E□□4R7MD07D
	100	6.3×7	0.20	110	ESRG160E□□101MF07D		4.7	5×9	0.12	38	ESRG500E□□4R7ME09D
	220	8×9	0.20	290	ESRG160E□□221MH09D		10	5×7	0.12	42	ESRG500E□□100ME07D
	330	8×9	0.20	355	ESRG160E□□331MH09D		10	5×9	0.12	64	ESRG500E□□100ME09D
	470	10×9	0.20	410	ESRG160E□□471MJ09S	22	5×9	0.12	86	ESRG500E□□220ME09D	
	1,000	12.5×13	0.20	715	ESRG160E□□102MK13S	22	6.3×7	0.12	64	ESRG500E□□220MF07D	
	2,200	16×15	0.23	1,160	ESRG160E□□222ML15S	33	6.3×9	0.12	113	ESRG500E□□330MF09D	
	3,300	18×15	0.26	1,460	ESRG160E□□332MM15S	33	8×7	0.12	93	ESRG500E□□330MH07D	
	4,700	18×20	0.29	1,770	ESRG160E□□472MM20S	47	6.3×9	0.12	135	ESRG500E□□470MF09D	
6,800	18×25	0.35	2,170	ESRG160E□□682MM25S	100	10×9	0.12	240	ESRG500E□□101MJ09S		
25	33	5×7	0.16	66	ESRG250E□□330ME07D	220	10×12.5	0.12	415	ESRG500E□□221MJC5S	
	47	5×9	0.16	105	ESRG250E□□470ME09D	330	12.5×13	0.12	525	ESRG500E□□331MK13S	
	47	6.3×7	0.16	80	ESRG250E□□470MF07D	470	16×15	0.12	745	ESRG500E□□471ML15S	
	100	6.3×9	0.16	172	ESRG250E□□101MF09D	1,000	18×20	0.12	1,160	ESRG500E□□102MM20S	
	330	10×9	0.16	380	ESRG250E□□331MJ09S						

□□ : Enter the appropriate lead forming or taping code.

◆RATED RIPPLE CURRENT MULTIPLIERS

●Frequency Multipliers

Capacitance (μF)	Frequency (Hz)					
	50	120	300	1k	10k	100k
to 4.7	0.65	1.00	1.35	1.75	2.30	2.50
10 to 47	0.75	1.00	1.25	1.50	1.75	1.80
100 to 1,000	0.80	1.00	1.15	1.30	1.40	1.50
2,200 to	0.85	1.00	1.03	1.05	1.08	1.08

KRG Series

- Low profile : $\phi 4 \times 7\text{mm}$ to $\phi 18 \times 25\text{mm}$
- Endurance : 1,000 hours at 105°C
- Solvent resistant type (see PRECAUTIONS AND GUIDELINES)
- RoHS Compliant

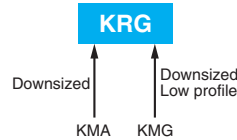

◆ SPECIFICATIONS

Items	Characteristics	
Category Temperature Range	-55 to +105°C	
Rated Voltage Range	6.3 to 50V _{dc}	
Capacitance Tolerance	±20% (M) (at 20°C, 120Hz)	
Leakage Current	I=0.01CV or 3μA, whichever is greater. Where, I : Max. leakage current (μA), C : Nominal capacitance (μF), V : Rated voltage (V) (at 20°C after 2 minutes)	
Dissipation Factor (tanδ)	Rated voltage (V _{dc})	6.3V 10V 16V 25V 35V 50V
	tanδ (Max.)	0.28 0.24 0.20 0.16 0.14 0.12
	When nominal capacitance exceeds 1,000μF, add 0.03 to the value above for each 1,000μF increase. (at 20°C, 120Hz)	
Low Temperature Characteristics (Max. Impedance Ratio)	Rated voltage (V _{dc})	6.3V 10V 16V 25V 35V 50V
	Z(-25°C)/Z(+20°C)	5 4 3 2 2 2
	Z(-40°C)/Z(+20°C)	10 8 6 4 3 3
	(at 120Hz)	
Endurance	The following specifications shall be satisfied when the capacitors are restored to 20°C after the rated voltage is applied for 1,000 hours at 105°C.	
	Rated voltage	6.3 to 16V _{dc} 25 to 50V _{dc}
	Capacitance change	≤±25% of the initial value ≤±20% of the initial value
	D.F. (tanδ)	≤200% of the initial specified value ≤200% of the initial specified value
	Leakage current	≤The initial specified value ≤The initial specified value
Shelf Life	The following specifications shall be satisfied when the capacitors are restored to 20°C after exposing them for 500 hours at 105°C without voltage applied. Before the measurement, the capacitor shall be preconditioned by applying voltage according to Item 4.1 of JIS C 5101-4.	
	Rated voltage	6.3 to 16V _{dc} 25 to 50V _{dc}
	Capacitance change	≤±25% of the initial value ≤±20% of the initial value
	D.F. (tanδ)	≤200% of the initial specified value ≤200% of the initial specified value
	Leakage current	≤The initial specified value ≤The initial specified value

◆ DIMENSIONS [mm]

- Terminal Code : E

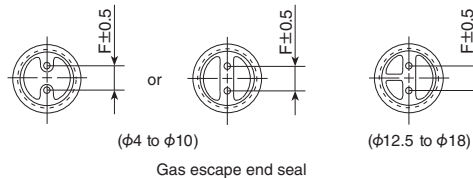
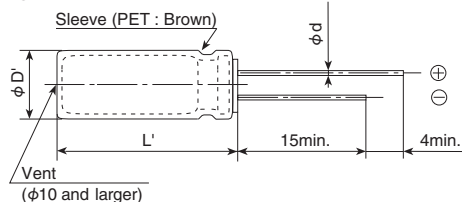

φD	4	5	6.3	8	10 & 12.5	16 & 18
7L	0.45	0.45	0.45	-	-	-
φd	≥9L	0.5	0.5	0.6	0.6	0.8
F	1.5	2.0	2.5	3.5	5.0	7.5
φD'	φD+0.5max.					
L'	L+1.5max. (7L : L+1.0max.)					

◆ PART NUMBERING SYSTEM

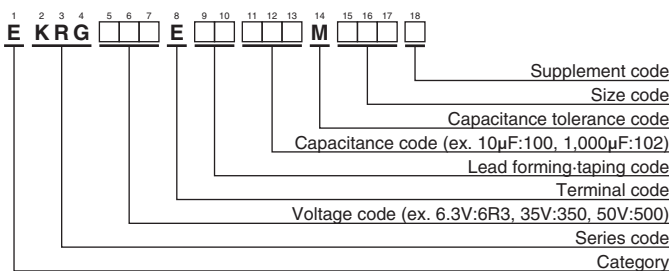

Please refer to "Product code guide (radial lead type)"

◆STANDARD RATINGS

WV (Vdc)	Cap (μF)	Case size φD×L(mm)	tanδ	Rated ripple current (mA rms/105°C, 120Hz)	Part No.	WV (Vdc)	Cap (μF)	Case size φD×L(mm)	tanδ	Rated ripple current (mA rms/105°C, 120Hz)	Part No.
6.3	47	5×7	0.28	50	EKRG6R3E□□470ME07D	25	470	10×12.5	0.16	370	EKRG250E□□471MJC5S
	330	6.3×9	0.28	175	EKRG6R3E□□331MF09D		1,000	12.5×15	0.16	590	EKRG250E□□102MK15S
	1,000	10×9	0.28	365	EKRG6R3E□□102MJ09S		2,200	18×15	0.19	970	EKRG250E□□222MM15S
	4,700	16×15	0.37	1,010	EKRG6R3E□□472ML15S		3,300	18×20	0.22	1,220	EKRG250E□□332MM20S
	6,800	18×15	0.43	1,190	EKRG6R3E□□682MM15S		4,700	18×25	0.25	1,470	EKRG250E□□472MM25S
	10,000	18×20	0.55	1,440	EKRG6R3E□□103MM20S		35	10	5×7	0.14	36
10	22	4×7	0.24	35	EKRG100E□□220MD07D	22		6.3×7	0.14	57	EKRG350E□□220MF07D
	100	5×9	0.24	93	EKRG100E□□101ME09D	33		5×9	0.14	67	EKRG350E□□330ME09D
	100	6.3×7	0.24	80	EKRG100E□□101MF07D	33		6.3×7	0.14	64	EKRG350E□□330MF07D
	220	6.3×9	0.24	154	EKRG100E□□221MF09D	100		8×9	0.14	155	EKRG350E□□101MH09D
	470	8×9	0.24	272	EKRG100E□□471MH09D	220		10×9	0.14	235	EKRG350E□□221MJ09S
	1,000	10×12.5	0.24	445	EKRG100E□□102MJC5S	330		10×12.5	0.14	340	EKRG350E□□331MJC5S
	2,200	12.5×15	0.27	690	EKRG100E□□222MK15S	470		12.5×13	0.14	415	EKRG350E□□471MK13S
	3,300	16×15	0.30	940	EKRG100E□□332ML15S	1,000		16×15	0.14	720	EKRG350E□□102ML15S
	4,700	18×15	0.33	1,120	EKRG100E□□472MM15S	2,200		18×20	0.17	1,110	EKRG350E□□222MM20S
	6,800	18×20	0.39	1,330	EKRG100E□□682MM20S	50		1.0	4×7	0.12	10
10,000	18×25	0.51	1,700	EKRG100E□□103MM25S	1.0			5×9	0.12	12	EKRG500E□□1R0ME09D
16	33	5×7	0.20	53	EKRG160E□□330ME07D		2.2	4×7	0.12	15	EKRG500E□□2R2MD07D
	47	6.3×7	0.20	68	EKRG160E□□470MF07D		2.2	5×9	0.12	18	EKRG500E□□2R2ME09D
	100	6.3×7	0.20	97	EKRG160E□□101MF07D		3.3	4×7	0.12	18	EKRG500E□□3R3MD07D
	220	8×9	0.20	205	EKRG160E□□221MH09D		3.3	5×9	0.12	22	EKRG500E□□3R3ME09D
	330	8×9	0.20	251	EKRG160E□□331MH09D		4.7	4×7	0.12	25	EKRG500E□□4R7MD07D
	470	10×9	0.20	290	EKRG160E□□471MJ09S		4.7	5×9	0.12	27	EKRG500E□□4R7ME09D
	1,000	12.5×13	0.20	515	EKRG160E□□102MK13S		10	5×9	0.12	46	EKRG500E□□100ME09D
	2,200	16×15	0.23	830	EKRG160E□□222ML15S		10	6.3×7	0.12	44	EKRG500E□□100MF07D
	3,300	18×15	0.26	1,050	EKRG160E□□332MM15S		22	5×9	0.12	61	EKRG500E□□220ME09D
	4,700	18×20	0.29	1,260	EKRG160E□□472MM20S		22	6.3×7	0.12	57	EKRG500E□□220MF07D
6,800	18×25	0.35	1,560	EKRG160E□□682MM25S	33		6.3×9	0.12	80	EKRG500E□□330MF09D	
25	10	4×7	0.16	30	EKRG250E□□100MD07D		47	6.3×9	0.12	95	EKRG500E□□470MF09D
	22	5×7	0.16	46	EKRG250E□□220ME07D		100	10×9	0.12	170	EKRG500E□□101MJ09S
	33	6.3×7	0.16	63	EKRG250E□□330MF07D		220	10×12.5	0.12	290	EKRG500E□□221MJC5S
	47	5×9	0.16	75	EKRG250E□□470ME09D		330	12.5×13	0.12	370	EKRG500E□□331MK13S
	47	6.3×7	0.16	71	EKRG250E□□470MF07D		470	16×15	0.12	535	EKRG500E□□471ML15S
	100	6.3×9	0.16	121	EKRG250E□□101MF09D	1,000	18×20	0.12	830	EKRG500E□□102MM20S	
	330	10×9	0.16	270	EKRG250E□□331MJ09S						

□□ : Enter the appropriate lead forming or taping code.

◆RATED RIPPLE CURRENT MULTIPLIERS

●Frequency Multipliers

Capacitance (μF)	Frequency (Hz)					
	50	120	300	1k	10k	100k
to 4.7	0.65	1.00	1.35	1.75	2.30	2.50
10 to 47	0.75	1.00	1.25	1.50	1.75	1.80
100 to 1,000	0.80	1.00	1.15	1.30	1.40	1.50
2,200 to	0.85	1.00	1.03	1.05	1.08	1.08

SMQ Series

- Downsized from current standard SMG series
- Endurance : 2,000 hours at 85°C
- Non solvent resistant type
- RoHS Compliant



◆ SPECIFICATIONS

Items	Characteristics													
Category Temperature Range	-40 to +85°C(6.3 to 400V _{dc}) -25 to +85°C(450V _{dc})													
Rated Voltage Range	6.3 to 450V _{dc}													
Capacitance Tolerance	±20% (M) (at 20°C, 120Hz)													
Leakage Current	6.3 to 100V _{dc}						160 to 450V _{dc}							
	≤φ18	I=0.03CV or 4μA, whichever is greater.						CV / Time After 1minute						
							CV ≤ 1,000 I=0.1CV+40 max.							
	(at 20°C after 1 minute)						CV > 1,000 I=0.04CV+100 max.			(at 20°C)				
	≥ φ 20	I=0.03CV (at 20°C after 3 minutes)												
Where, I : Max. leakage current (μA), C : Nominal capacitance (μF), V : Rated voltage (V)														
Dissipation Factor (tanδ)	Rated voltage (V _{dc})	6.3V	10V	16V	25V	35V	50V	63V	100V	160 to 250V	315 to 400V	450V		
	tanδ (Max.)	0.28	0.24	0.20	0.16	0.14	0.12	0.09	0.08	0.20	0.24	0.24		
When nominal capacitance exceeds 1,000μF, add 0.02 to the value above for each 1,000μF increase. (at 20°C, 120Hz)														
Low Temperature Characteristics (Max. Impedance Ratio)	Rated voltage (V _{dc})	6.3V	10V	16V	25V	35V	50V	63V	100V	160 to 200V	250V	350V	400V	450V
	Z(-25°C)/Z(+20°C)	≤φ8	5	4	3	2	2	2	2	3	3	4	4	6
		≥φ10	5	4	3	2	2	2	2	3	3	4	4	6
	Z(-40°C)/Z(+20°C)	≤φ8	12	10	8	5	4	3	3	3	8	10	8	8
	≥φ10	12	10	8	5	4	3	3	3	4	4	6	6	—
(at 120Hz)														
Endurance	The following specifications shall be satisfied when the capacitors are restored to 20°C after the rated voltage is applied for 2,000 hours at 85°C.													
	Capacitance change	≤±20% of the initial value												
	D.F. (tanδ)	≤200% of the initial specified value												
	Leakage current	≤The initial specified value												
Shelf Life	The following specifications shall be satisfied when the capacitors are restored to 20°C after exposing them for 1,000 hours at 85°C without voltage applied. Before the measurement, the capacitor shall be preconditioned by applying voltage according to Item 4.1 of JIS C 5101-4.													
	Rated voltage	6.3 to 100V _{dc}						160 to 450V _{dc}						
	Capacitance change	≤±20% of the initial value						≤±20% of the initial value						
	D.F. (tanδ)	≤200% of the initial specified value						≤200% of the initial specified value						
	Leakage current	≤The initial specified value						≤500% of the initial specified value						

◆ DIMENSIONS [mm]

- Terminal Code : E

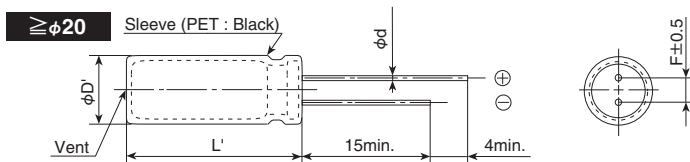
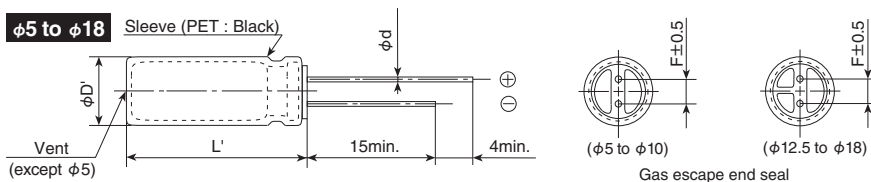

φD	5	6.3	8	10	12.5	16	18	20	22
φd	0.5	0.5	0.6	0.6	0.6	0.8	0.8	1.0	1.0
F	2.0	2.5	3.5	5.0	5.0	7.5	7.5	10.0	10.0
φD'	φD+0.5max.							φD+0.5max.	
L'	L+1.5max.							L+2.0max.	

◆ PART NUMBERING SYSTEM

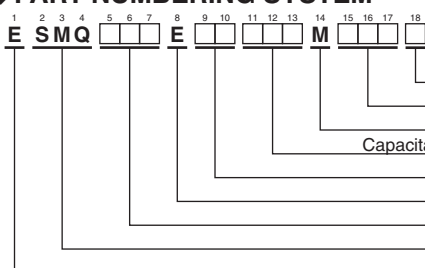

Supplement code
Size code
Capacitance tolerance code
Capacitance code (ex. 1.0μF:1R0,10μF:100,100μF:101)
Lead forming-taping code
Terminal code
Voltage code (ex. 6.3V:6R3,50V:500,100V:101)
Series code
Category

Please refer to "Product code guide (radial lead type)"

◆ STANDARD RATINGS

WV (Vdc)	Cap (μF)	Case size φD×L(mm)	tanδ	Rated ripple current (mArms/85°C,120Hz)	Part No.	WV (Vdc)	Cap (μF)	Case size φD×L(mm)	tanδ	Rated ripple current (mArms/85°C,120Hz)	Part No.	
6.3	1,000	8×11.5	0.28	540	ESMQ6R3E□□102MHB5D	50	330	10×16	0.12	590	ESMQ500E□□331MJ16S	
	2,200	10×16	0.30	890	ESMQ6R3E□□222MJ16S		470	10×20	0.12	760	ESMQ500E□□471MJ20S	
	3,300	10×20	0.32	1,190	ESMQ6R3E□□332MJ20S		1,000	12.5×25	0.12	1,350	ESMQ500E□□102MK25S	
	4,700	12.5×20	0.34	1,550	ESMQ6R3E□□472MK20S		2,200	16×31.5	0.14	1,980	ESMQ500E□□222MLN3S	
	6,800	12.5×25	0.38	1,920	ESMQ6R3E□□682MK25S		3,300	18×35.5	0.16	2,500	ESMQ500E□□332MMP1S	
	10,000	16×25	0.46	2,350	ESMQ6R3E□□103ML25S		4,700	20×40	0.18	2,900	ESMQ500E□□472MN40S	
	15,000	16×31.5	0.56	2,550	ESMQ6R3E□□153MLN3S		6,800	22×50	0.22	3,500	ESMQ500E□□682MP50S	
	22,000	18×35.5	0.70	3,200	ESMQ6R3E□□223MMP1S		63	22	5×11	0.09	100	ESMQ630E□□220ME11D
	33,000	20×40	0.92	3,500	ESMQ6R3E□□333MN40S			33	6.3×11	0.09	140	ESMQ630E□□330MF11D
	47,000	20×50	1.20	3,900	ESMQ6R3E□□473MP50S			47	6.3×11	0.09	170	ESMQ630E□□470MF11D
10	220	5×11	0.24	240	ESMQ100E□□221ME11D	68		8×11.5	0.09	220	ESMQ630E□□680MHB5D	
	330	6.3×11	0.24	290	ESMQ100E□□331MF11D	100		8×11.5	0.09	280	ESMQ630E□□101MHB5D	
	470	6.3×11	0.24	350	ESMQ100E□□471MF11D	220		10×16	0.09	490	ESMQ630E□□221MJ16S	
	1,000	10×12.5	0.24	650	ESMQ100E□□102MJC5S	330		10×20	0.09	710	ESMQ630E□□331MJ20S	
	2,200	10×16	0.26	990	ESMQ100E□□221MJ16S	470		12.5×20	0.09	900	ESMQ630E□□471MK20S	
	3,300	12.5×20	0.28	1,450	ESMQ100E□□332MK20S	1,000		16×25	0.09	1,300	ESMQ630E□□102ML25S	
	4,700	12.5×25	0.30	1,800	ESMQ100E□□472MK25S	2,200		18×35.5	0.11	2,300	ESMQ630E□□222MMP1S	
	6,800	16×25	0.34	2,250	ESMQ100E□□682ML25S	3,300	20×40	0.13	2,700	ESMQ630E□□332MN40S		
	10,000	16×31.5	0.42	2,550	ESMQ100E□□103MLN3S	4,700	22×50	0.15	3,400	ESMQ630E□□472MP50S		
	15,000	16×35.5	0.52	2,880	ESMQ100E□□153MLP1S	100	1.0	5×11	0.08	21	ESMQ101E□□1R0ME11D	
22,000	18×40	0.66	3,400	ESMQ100E□□223MM40S	2.2		5×11	0.08	30	ESMQ101E□□2R2ME11D		
33,000	22×50	0.88	4,500	ESMQ100E□□333MP50S	3.3		5×11	0.08	40	ESMQ101E□□3R3ME11D		
16	220	6.3×11	0.20	260	ESMQ160E□□221MF11D		4.7	5×11	0.08	45	ESMQ101E□□4R7ME11D	
	330	6.3×11	0.20	320	ESMQ160E□□331MF11D		10	5×11	0.08	70	ESMQ101E□□100ME11D	
	470	8×11.5	0.20	440	ESMQ160E□□471MHB5D		22	6.3×11	0.08	130	ESMQ101E□□220MF11D	
	1,000	10×12.5	0.20	700	ESMQ160E□□102MJC5S		33	8×11.5	0.08	180	ESMQ101E□□330MHB5D	
	2,200	10×20	0.22	1,000	ESMQ160E□□222MJ20S		47	8×11.5	0.08	200	ESMQ101E□□470MHB5D	
	3,300	12.5×25	0.24	1,700	ESMQ160E□□332MK25S		68	10×12.5	0.08	270	ESMQ101E□□680MJC5S	
	4,700	16×25	0.26	2,100	ESMQ160E□□472ML25S		100	10×16	0.08	340	ESMQ101E□□101MJ16S	
	6,800	16×25	0.30	2,250	ESMQ160E□□682ML25S	220	12.5×20	0.08	550	ESMQ101E□□221MK20S		
	10,000	16×35.5	0.38	2,710	ESMQ160E□□103MLP1S	330	12.5×25	0.08	760	ESMQ101E□□331MK25S		
	15,000	18×40	0.48	3,100	ESMQ160E□□153MM40S	470	16×25	0.08	1,000	ESMQ101E□□471ML25S		
22,000	22×40	0.62	3,800	ESMQ160E□□223MP40S	1,000	18×35.5	0.08	1,350	ESMQ101E□□102MMP1S			
25	100	5×11	0.16	180	ESMQ250E□□101ME11D	2,200	22×50	0.10	2,400	ESMQ101E□□222MP50S		
	220	6.3×11	0.16	280	ESMQ250E□□221MF11D	160	10	8×11.5	0.20	80	ESMQ161E□□100MHB5D	
	330	8×11.5	0.16	440	ESMQ250E□□331MHB5D		22	10×12.5	0.20	130	ESMQ161E□□220MJC5S	
	470	10×12.5	0.16	550	ESMQ250E□□471MJC5S		33	10×16	0.20	180	ESMQ161E□□330MJ16S	
	1,000	10×16	0.16	860	ESMQ250E□□102MJ16S		47	10×20	0.20	210	ESMQ161E□□470MJ20S	
	2,200	12.5×25	0.18	1,550	ESMQ250E□□222MK25S		68	12.5×20	0.20	350	ESMQ161E□□680MK20S	
	3,300	16×25	0.20	1,980	ESMQ250E□□332ML25S		100	12.5×25	0.20	430	ESMQ161E□□101MK25S	
	4,700	16×25	0.22	2,200	ESMQ250E□□472ML25S		220	16×31.5	0.20	760	ESMQ161E□□221MLN3S	
	6,800	16×35.5	0.26	2,600	ESMQ250E□□682MLP1S		330	18×35.5	0.20	995	ESMQ161E□□331MMP1S	
	10,000	18×40	0.34	2,800	ESMQ250E□□103MM40S		470	18×40	0.20	1,200	ESMQ161E□□471MM40S	
15,000	22×50	0.44	3,800	ESMQ250E□□153MP50S	200		1.0	6.3×11	0.20	22	ESMQ201E□□1R0MF11D	
35	47	5×11	0.14	130		ESMQ350E□□470ME11D	2.2	6.3×11	0.20	33	ESMQ201E□□2R2MF11D	
	68	6.3×11	0.14	160		ESMQ350E□□680MF11D	3.3	6.3×11	0.20	40	ESMQ201E□□3R3MF11D	
	100	6.3×11	0.14	210		ESMQ350E□□101MF11D	4.7	6.3×11	0.20	50	ESMQ201E□□4R7MF11D	
	220	8×11.5	0.14	385		ESMQ350E□□221MHB5D	10	8×11.5	0.20	80	ESMQ201E□□3R0MHB5D	
	330	10×12.5	0.14	490		ESMQ350E□□331MJC5S	22	10×16	0.20	150	ESMQ201E□□220MJ16S	
	470	10×16	0.14	650		ESMQ350E□□471MJ16S	33	10×20	0.20	205	ESMQ201E□□330MJ20S	
	1,000	12.5×20	0.14	1,150		ESMQ350E□□102MK20S	47	12.5×20	0.20	270	ESMQ201E□□470MK20S	
	2,200	16×25	0.16	1,800		ESMQ350E□□222ML25S	68	12.5×25	0.20	350	ESMQ201E□□680MK25S	
	3,300	16×31.5	0.18	2,100		ESMQ350E□□332MLN3S	100	16×25	0.20	475	ESMQ201E□□101ML25S	
	4,700	16×35.5	0.20	2,500	ESMQ350E□□472MLP1S	220	16×35.5	0.20	700	ESMQ201E□□221MLP1S		
6,800	18×40	0.24	2,800	ESMQ350E□□682MM40S	330	18×40	0.20	950	ESMQ201E□□331MM40S			
10,000	22×50	0.32	3,700	ESMQ350E□□103MP50S	250	3.3	6.3×11	0.20	40	ESMQ251E□□3R3MF11D		
50	1.0	5×11	0.12	17		ESMQ500E□□1R0ME11D	4.7	6.3×11	0.20	50	ESMQ251E□□4R7MF11D	
	2.2	5×11	0.12	28		ESMQ500E□□2R2ME11D	10	10×12.5	0.20	100	ESMQ251E□□100MJC5S	
	3.3	5×11	0.12	35		ESMQ500E□□3R3ME11D	22	10×20	0.20	170	ESMQ251E□□220MJ20S	
	4.7	5×11	0.12	41		ESMQ500E□□4R7ME11D	33	10×20	0.20	200	ESMQ251E□□330MJ20S	
	10	5×11	0.12	60		ESMQ500E□□100ME11D	47	12.5×20	0.20	270	ESMQ251E□□470MK20S	
	22	5×11	0.12	95		ESMQ500E□□220ME11D	68	16×25	0.20	380	ESMQ251E□□680ML25S	
	33	5×11	0.12	125		ESMQ500E□□330ME11D	100	16×25	0.20	440	ESMQ251E□□101ML25S	
	47	6.3×11	0.12	155		ESMQ500E□□470MF11D	220	18×35.5	0.20	680	ESMQ251E□□221MMP1S	
	68	6.3×11	0.12	210		ESMQ500E□□680MF11D	350	2.2	6.3×11	0.24	30	ESMQ351E□□2R2MF11D
	100	8×11.5	0.12	260	ESMQ500E□□101MHB5D	3.3		8×11.5	0.24	46	ESMQ351E□□3R3MHB5D	
220	10×12.5	0.12	430	ESMQ500E□□221MJC5S	4.7	8×11.5		0.24	55	ESMQ351E□□4R7MHB5D		

□□ : Enter the appropriate lead forming or taping code.

◆STANDARD RATINGS

WV (V _{dc})	Cap (μF)	Case size φD×L(mm)	tan δ	Rated ripple current (mA _{rms} /85°C, 120Hz)	Part No.	WV (V _{dc})	Cap (μF)	Case size φD×L(mm)	tan δ	Rated ripple current (mA _{rms} /85°C, 120Hz)	Part No.
350	10	10×12.5	0.24	90	ESMQ351E□□100MJC5S	450	2.2	8×11.5	0.24	28	ESMQ451E□□2R2MHB5D
	22	12.5×20	0.24	185	ESMQ351E□□220MK20S		3.3	10×12.5	0.24	40	ESMQ451E□□3R3MJC5S
	33	12.5×25	0.24	240	ESMQ351E□□330MK25S		4.7	10×12.5	0.24	46	ESMQ451E□□4R7MJC5S
	47	16×25	0.24	325	ESMQ351E□□470ML25S		10	10×20	0.24	80	ESMQ451E□□100MJ20S
	68	16×25	0.24	400	ESMQ351E□□680ML25S		22	12.5×25	0.24	140	ESMQ451E□□220MK25S
	100	18×31.5	0.24	530	ESMQ351E□□101MMN3S		33	16×25	0.24	180	ESMQ451E□□330ML25S
400	1.0	6.3×11	0.24	22	ESMQ401E□□1R0MF11D		47	16×31.5	0.24	220	ESMQ451E□□470MLN3S
	2.2	8×11.5	0.24	38	ESMQ401E□□2R2MHB5D		68	18×35.5	0.24	260	ESMQ451E□□680MMP1S
	3.3	8×11.5	0.24	48	ESMQ401E□□3R3MHB5D		100	18×40	0.24	280	ESMQ451E□□101MM40S
	4.7	10×12.5	0.24	60	ESMQ401E□□4R7MJC5S						
	10	10×16	0.24	90	ESMQ401E□□100MJ16S						
	22	12.5×25	0.24	205	ESMQ401E□□220MK25S						
	33	16×25	0.24	275	ESMQ401E□□330ML25S						
	47	16×25	0.24	280	ESMQ401E□□470ML25S						
	68	16×31.5	0.24	340	ESMQ401E□□680MLN3S						
	100	18×35.5	0.24	440	ESMQ401E□□101MMP1S						

□□ : Enter the appropriate lead forming or taping code.

◆RATED RIPPLE CURRENT MULTIPLIERS

●Frequency Multipliers

(φ5 to φ18)

Capacitance (μF)	Frequency (Hz)					
	50	120	300	1k	10k	100k
1.0 to 4.7	0.65	1.00	1.35	1.75	2.30	2.50
10 to 68	0.75	1.00	1.25	1.50	1.75	1.80
100 to 1,000	0.80	1.00	1.15	1.30	1.40	1.50
2,200 to	0.85	1.00	1.03	1.05	1.08	1.08

(φ20 to φ22)

Rated Voltage (V _{dc})	Frequency (Hz)					
	50	120	300	1k	10k	100k
6.3 to 50	0.95	1.00	1.03	1.05	1.08	1.08
63 to 100	0.92	1.00	1.07	1.13	1.19	1.20

The endurance of capacitors is reduced with internal heating produced by ripple current at the rate of halving the lifetime with every 5°C rise. When long life performance is required in actual use, the rms ripple current has to be reduced.

KMQ Series

- Downsized from current standard KMG series
- Solvent resistant type except 160 to 450V_{dc}
(see PRECAUTIONS AND GUIDELINES)
- RoHS Compliant



SPECIFICATIONS

Items	Characteristics													
Category Temperature Range	-55 to +105°C(6.3 to 100V _{dc}) -40 to +105°C(160 to 400V _{dc}) -25 to +105°C(450V _{dc})													
Rated Voltage Range	6.3 to 450V _{dc}													
Capacitance Tolerance	±20% (M) (at 20°C, 120Hz)													
Leakage Current	6.3 to 100V _{dc}												160 to 450V _{dc}	
	≤ φ18	I=0.03CV or 4μA, whichever is greater.												CV \ Time After 1 minute
		(at 20°C after 1 minute)												
≥ φ20	I=0.03CV max.											I=0.04CV+100 max.		
(at 20°C after 3 minutes)														
Dissipation Factor (tanδ)	Where, I : Max. leakage current (μA), C : Nominal capacitance (μF), V : Rated voltage (V)													
	Rated voltage (V _{dc})	6.3V	10V	16V	25V	35V	50V	63V	100V	160 to 250V	350 to 400V	450V		
	tanδ (Max.)	0.28	0.24	0.20	0.16	0.14	0.12	0.10	0.08	0.20	0.24	0.24		
When nominal capacitance exceeds 1,000μF, add 0.02 to the value above for each 1,000μF increase. (at 20°C, 120Hz)														
Low Temperature Characteristics (Max. Impedance Ratio)	Rated voltage (V _{dc})	6.3V	10V	16V	25V	35V	50V	63 to 100V	160 to 200V	250V	350V	400V	450V	
	Z(-25°C)/Z(+20°C)	≤ φ8	5	4	3	2	2	2	2	3	3	4	4	6
		≤ φ10	5	4	3	2	2	2	2	3	3	4	4	6
	Z(-40°C)/Z(+20°C)	≤ φ8	10	8	6	4	3	3	3	8	10	8	8	—
	≤ φ10	10	8	6	4	3	3	3	4	4	6	6	—	
(at 120Hz)														
Endurance	The following specifications shall be satisfied when the capacitors are restored to 20°C after subjected to DC voltage with the rated ripple current is applied (the peak voltage shall not exceed the rated voltage) for 1,000 hours (2,000 hours for φ10 and more at 105°C).													
	Capacitance change	≤ ±20% of the initial value												
	D.F. (tanδ)	≤ 200% of the initial specified value												
	Leakage current	≤ The initial specified value												
Shelf Life	The following specifications shall be satisfied when the capacitors are restored to 20°C after exposing them for 1,000 hours at 105°C without voltage applied. Before the measurement, the capacitor shall be preconditioned by applying voltage according to Item 4.1 of JIS C 5101-4.													
	Rated voltage	6.3 to 100V _{dc}						160 to 450V _{dc}						
	Capacitance change	≤ ±20% of the initial value						≤ ±20% of the initial value						
	D.F. (tanδ)	≤ 200% of the initial specified value						≤ 200% of the initial specified value						
	Leakage current	≤ The initial specified value						≤ 500% of the initial specified value						

DIMENSIONS [mm]

- Terminal Code : E

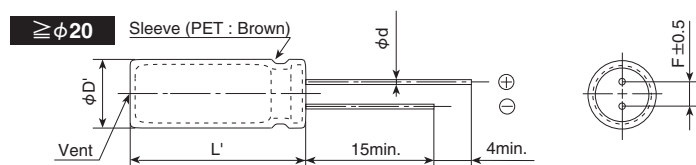
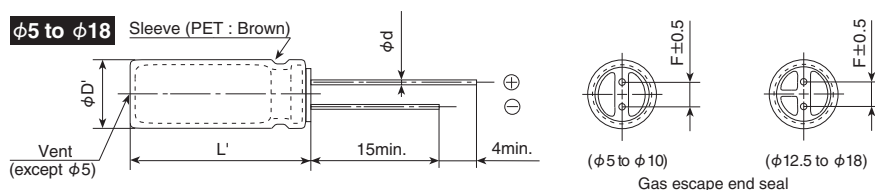

φD	5	6.3	8	10	12.5	16	18	20	22
φd	0.5	0.5	0.6	0.6	0.6	0.8	0.8	1.0	1.0
F	2.0	2.5	3.5	5.0	5.0	7.5	7.5	10.0	10.0
φD'	φD+0.5max.						φD+0.5max.		
L'	L+1.5max.						L+2.0max.		

PART NUMBERING SYSTEM

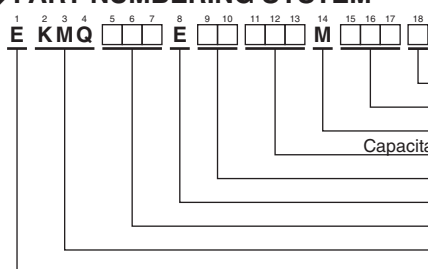

Supplement code
 Size code
 Capacitance tolerance code
 Capacitance code (ex. 1.0μF:1R0,10μF:100,100μF:101)
 Lead forming-taping code
 Terminal code
 Voltage code (ex. 6.3V:6R3,35V:350,100V:101)
 Series code
 Category

Please refer to "Product code guide (radial lead type)"

◆STANDARD RATINGS

□□ is not solvent resistant.

WV (Vdc)	Cap (μF)	Case size φD×L(mm)	tanδ	Rated ripple current (mArms/105°C,120Hz)	Part No.	WV (Vdc)	Cap (μF)	Case size φD×L(mm)	tanδ	Rated ripple current (mArms/105°C,120Hz)	Part No.		
6.3	1,000	8×11.5	0.28	390	EKMQ6R3E□□102MHB5D	50	330	10×16	0.12	410	EKMQ500E□□331MJ16S		
	2,200	10×16	0.30	635	EKMQ6R3E□□222MJ16S		470	10×20	0.12	540	EKMQ500E□□471MJ20S		
	3,300	10×20	0.32	840	EKMQ6R3E□□332MJ20S		1,000	12.5×25	0.12	950	EKMQ500E□□102MK25S		
	4,700	12.5×20	0.34	1,090	EKMQ6R3E□□472MK20S		2,200	16×31.5	0.14	1,410	EKMQ500E□□222MLN3S		
	6,800	12.5×25	0.38	1,350	EKMQ6R3E□□682MK25S		3,300	18×35.5	0.16	1,770	EKMQ500E□□332MMP1S		
	10,000	16×25	0.46	1,650	EKMQ6R3E□□103ML25S		4,700	20×40	0.18	2,100	EKMQ500E□□472MN40S		
	15,000	16×31.5	0.56	1,820	EKMQ6R3E□□153MLN3S		6,800	22×50	0.22	2,500	EKMQ500E□□682MP50S		
	22,000	18×35.5	0.70	2,280	EKMQ6R3E□□223MMP1S		63	22	5×11	0.10	71	EKMQ630E□□220ME11D	
	33,000	20×40	0.92	2,500	EKMQ6R3E□□333MM40S			33	6.3×11	0.10	100	EKMQ630E□□330MF11D	
47,000	22×50	1.20	2,780	EKMQ6R3E□□473MP50S	47	6.3×11		0.10	120	EKMQ630E□□470MF11D			
10	220	5×11	0.24	155	EKMQ100E□□221MF11D	68		8×11.5	0.10	155	EKMQ630E□□680MHB5D		
	330	6.3×11	0.24	210	EKMQ100E□□331MF11D	100		8×11.5	0.10	200	EKMQ630E□□101MHB5D		
	470	6.3×11	0.24	250	EKMQ100E□□471MF11D	220		10×16	0.10	335	EKMQ630E□□221MJ16S		
	1,000	10×12.5	0.24	460	EKMQ100E□□102MJC5S	330		10×20	0.10	510	EKMQ630E□□331MJ20S		
	2,200	10×16	0.26	705	EKMQ100E□□222MJ16S	470		12.5×20	0.10	640	EKMQ630E□□471MK20S		
	3,300	12.5×20	0.28	1,000	EKMQ100E□□332MK20S	1,000		16×25	0.10	930	EKMQ630E□□102ML25S		
	4,700	12.5×25	0.30	1,260	EKMQ100E□□472MK25S	2,200		18×35.5	0.12	1,650	EKMQ630E□□222MMP1S		
	6,800	16×25	0.34	1,570	EKMQ100E□□682ML25S	3,300		20×40	0.14	1,950	EKMQ630E□□332MN40S		
	10,000	16×31.5	0.42	1,820	EKMQ100E□□103MLN3S	4,700		22×50	0.16	2,450	EKMQ630E□□472MP50S		
	15,000	16×35.5	0.52	2,050	EKMQ100E□□153MLP1S	100		1.0	5×11	0.08	15	EKMQ101E□□1R0ME11D	
	22,000	18×40	0.66	2,420	EKMQ100E□□223MM40S			2.2	5×11	0.08	21	EKMQ101E□□2R2ME11D	
	33,000	22×50	0.88	3,210	EKMQ100E□□333MP50S			3.3	5×11	0.08	29	EKMQ101E□□3R3ME11D	
	16	220	6.3×11	0.20	190		EKMQ160E□□221MF11D	4.7	5×11	0.08	32	EKMQ101E□□4R7ME11D	
		330	6.3×11	0.20	225		EKMQ160E□□331MF11D	10	5×11	0.08	50	EKMQ101E□□100ME11D	
		470	8×11.5	0.20	315		EKMQ160E□□471MHB5D	22	6.3×11	0.08	93	EKMQ101E□□220MF11D	
1,000		10×12.5	0.20	500	EKMQ160E□□102MJC5S		33	8×11.5	0.08	130	EKMQ101E□□330MHB5D		
2,200		10×20	0.22	710	EKMQ160E□□222MJ20S		47	8×11.5	0.08	140	EKMQ101E□□470MHB5D		
3,300		12.5×25	0.24	1,170	EKMQ160E□□332MK25S		68	10×12.5	0.08	190	EKMQ101E□□680MJC5S		
4,700		16×25	0.26	1,500	EKMQ160E□□472ML25S		100	10×16	0.08	240	EKMQ101E□□101MJ16S		
6,800		16×25	0.30	1,600	EKMQ160E□□682ML25S		220	12.5×20	0.08	390	EKMQ101E□□221MK20S		
10,000		16×35.5	0.38	1,930	EKMQ160E□□103MLP1S		330	12.5×25	0.08	540	EKMQ101E□□331MK25S		
15,000		18×40	0.48	2,210	EKMQ160E□□153MM40S		470	16×25	0.08	715	EKMQ101E□□471ML25S		
22,000		22×40	0.62	2,710	EKMQ160E□□223MP40S		1,000	18×35.5	0.08	960	EKMQ101E□□102MMP1S		
25		100	5×11	0.16	125		EKMQ250E□□101ME11D	2,200	22×50	0.10	1,750	EKMQ101E□□222MP50S	
		220	6.3×11	0.16	200	EKMQ250E□□221MF11D	160	10	8×11.5	0.20	41	EKMQ161E□□100MHB5D	
		330	8×11.5	0.16	310	EKMQ250E□□331MHB5D		22	10×12.5	0.20	92	EKMQ161E□□220MJC5S	
		470	10×12.5	0.16	380	EKMQ250E□□471MJC5S		33	10×16	0.20	125	EKMQ161E□□330MJ16S	
	1,000	10×16	0.16	610	EKMQ250E□□102MJ16S	47		10×20	0.20	150	EKMQ161E□□470MJ20S		
	2,200	12.5×25	0.18	1,090	EKMQ250E□□222MK25S	68		12.5×20	0.20	250	EKMQ161E□□680MK20S		
	3,300	16×25	0.20	1,400	EKMQ250E□□332ML25S	100		12.5×25	0.20	310	EKMQ161E□□101MK25S		
	4,700	16×25	0.22	1,570	EKMQ250E□□472ML25S	220		16×31.5	0.20	540	EKMQ161E□□221MLN3S		
	6,800	16×35.5	0.26	1,850	EKMQ250E□□682MLP1S	330		18×35.5	0.20	705	EKMQ161E□□331MMP1S		
	10,000	18×40	0.34	2,000	EKMQ250E□□103MM40S	470		18×40	0.20	855	EKMQ161E□□471MM40S		
	15,000	22×50	0.44	2,750	EKMQ250E□□153MP50S	200		1.0	6.3×11	0.20	16	EKMQ201E□□1R0MF11D	
	35	47	5×11	0.14	93			EKMQ350E□□470ME11D	2.2	6.3×11	0.20	25	EKMQ201E□□2R2MF11D
		68	6.3×11	0.14	110			EKMQ350E□□680MF11D	3.3	6.3×11	0.20	30	EKMQ201E□□3R3MF11D
		100	6.3×11	0.14	150			EKMQ350E□□101MF11D	4.7	6.3×11	0.20	35	EKMQ201E□□4R7MF11D
		220	8×11.5	0.14	270			EKMQ350E□□221MHB5D	10	8×11.5	0.20	57	EKMQ201E□□103MHB5D
330		10×12.5	0.14	350	EKMQ350E□□331MJC5S			22	10×16	0.20	105	EKMQ201E□□220MJ16S	
470		10×16	0.14	460	EKMQ350E□□471MJ16S		33	10×20	0.20	140	EKMQ201E□□330MJ20S		
1,000		12.5×20	0.14	810	EKMQ350E□□102MK20S		47	12.5×20	0.20	195	EKMQ201E□□470MK20S		
2,200		16×25	0.16	1,260	EKMQ350E□□222ML25S		68	12.5×25	0.20	250	EKMQ201E□□680MK25S		
3,300		16×31.5	0.18	1,500	EKMQ350E□□332MLN3S		100	16×25	0.20	335	EKMQ201E□□101ML25S		
4,700		16×35.5	0.20	1,780	EKMQ350E□□472MLP1S		220	16×35.5	0.20	500	EKMQ201E□□221MLP1S		
6,800		18×40	0.24	2,000	EKMQ350E□□682MM40S		330	18×40	0.20	675	EKMQ201E□□331MM40S		
10,000		22×50	0.32	2,650	EKMQ350E□□103MP50S		250	3.3	6.3×11	0.20	28	EKMQ251E□□1R0MF11D	
50		1.0	5×11	0.12	13			EKMQ500E□□1R0ME11D	4.7	6.3×11	0.20	35	EKMQ251E□□4R7MF11D
		2.2	5×11	0.12	20			EKMQ500E□□2R2ME11D	10	10×12.5	0.20	71	EKMQ251E□□100MJC5S
		3.3	5×11	0.12	25	EKMQ500E□□3R3ME11D		22	10×20	0.20	105	EKMQ251E□□220MJ20S	
	4.7	5×11	0.12	30	EKMQ500E□□4R7ME11D	33		10×20	0.20	140	EKMQ251E□□330MJ20S		
	10	5×11	0.12	46	EKMQ500E□□100ME11D	47		12.5×20	0.20	190	EKMQ251E□□470MK20S		
	22	5×11	0.12	68	EKMQ500E□□220ME11D	68		16×25	0.20	270	EKMQ251E□□680ML25S		
	33	5×11	0.12	90	EKMQ500E□□330ME11D	100		16×25	0.20	310	EKMQ251E□□101ML25S		
	47	6.3×11	0.12	115	EKMQ500E□□470MF11D	220		18×35.5	0.20	485	EKMQ251E□□221MMP1S		
	68	6.3×11	0.12	150	EKMQ500E□□680MF11D	350		2.2	6.3×11	0.24	21	EKMQ351E□□2R2MF11D	
	100	8×11.5	0.12	190	EKMQ500E□□101MHB5D			3.3	8×11.5	0.24	30	EKMQ351E□□3R3MHB5D	
	220	10×12.5	0.12	300	EKMQ500E□□221MJC5S			4.7	8×11.5	0.24	39	EKMQ351E□□4R7MHB5D	

□□: Enter the appropriate lead forming or taping code.

◆STANDARD RATINGS

□ is not solvent resistant.

WV (Vdc)	Cap (μF)	Case size φD×L(mm)	tan δ	Rated ripple current (mA _{rms} /105°C,120Hz)	Part No.
350	10	10×12.5	0.24	64	EKMQ351E□□100MJC5S
	22	12.5×20	0.24	130	EKMQ351E□□220MK20S
	33	12.5×25	0.24	170	EKMQ351E□□330MK25S
	47	16×25	0.24	230	EKMQ351E□□470ML25S
	68	16×25	0.24	285	EKMQ351E□□680ML25S
	100	18×31.5	0.24	375	EKMQ351E□□101MMN3S
400	1.0	6.3×11	0.24	15	EKMQ401E□□1R0MF11D
	2.2	8×11.5	0.24	27	EKMQ401E□□2R2MHB5D
	3.3	8×11.5	0.24	34	EKMQ401E□□3R3MHB5D
	4.7	10×12.5	0.24	42	EKMQ401E□□4R7MJC5S
	10	10×16	0.24	64	EKMQ401E□□100MJ16S
	22	12.5×25	0.24	145	EKMQ401E□□220MK25S
	33	16×25	0.24	195	EKMQ401E□□330ML25S
	47	16×25	0.24	200	EKMQ401E□□470ML25S
	68	16×31.5	0.24	240	EKMQ401E□□680MLN3S
	100	18×35.5	0.24	310	EKMQ401E□□101MMP1S

WV (Vdc)	Cap (μF)	Case size φD×L(mm)	tan δ	Rated ripple current (mA _{rms} /105°C,120Hz)	Part No.
450	2.2	8×11.5	0.24	20	EKMQ451E□□2R2MHB5D
	3.3	10×12.5	0.24	28	EKMQ451E□□3R3MJC5S
	4.7	10×12.5	0.24	32	EKMQ451E□□4R7MJC5S
	10	10×20	0.24	56	EKMQ451E□□100MJ20S
	22	12.5×25	0.24	100	EKMQ451E□□220MK25S
	33	16×25	0.24	125	EKMQ451E□□330ML25S
	47	16×31.5	0.24	155	EKMQ451E□□470MLN3S
	68	18×35.5	0.24	185	EKMQ451E□□680MMP1S
	100	18×40	0.24	200	EKMQ451E□□101MM40S

□ : Enter the appropriate lead forming or taping code.

◆RATED RIPPLE CURRENT MULTIPLIERS

●Frequency Multipliers

(φ5 to φ18)

Capacitance (μF)	Frequency (Hz)					
	50	120	300	1k	10k	100k
1.0 to 4.7	0.65	1.00	1.35	1.75	2.30	2.50
10 to 68	0.75	1.00	1.25	1.50	1.75	1.80
100 to 1,000	0.80	1.00	1.15	1.30	1.40	1.50
2,200 to	0.85	1.00	1.03	1.05	1.08	1.08

(φ20 to φ22)

Rated Voltage (Vdc)	Frequency (Hz)					
	50	120	300	1k	10k	100k
6.3 to 50	0.95	1.00	1.03	1.05	1.08	1.08
63 to 100	0.92	1.00	1.07	1.13	1.19	1.20

The endurance of capacitors is reduced with internal heating produced by ripple current at the rate of halving the lifetime with every 5°C rise. When long life performance is required in actual use, the rms ripple current has to be reduced.

◆STANDARD RATINGS

WV (Vdc)	Cap (μF)	Case size φD×L(mm)	tanδ	Rated ripple current (mA rms/85°C, 120Hz)	Part No.	WV (Vdc)	Cap (μF)	Case size φD×L(mm)	tanδ	Rated ripple current (mA rms/85°C, 120Hz)	Part No.	
6.3	220	5×11	0.34	200	ESMG6R3E□□221ME11D	25	6,800	22×30	0.26	2,510	ESMG250E□□682MP30S	
	330	6.3×11	0.34	270	ESMG6R3E□□331MF11D		8,200	20×40	0.30	2,810	ESMG250E□□822MN40S	
	470	6.3×11	0.34	320	ESMG6R3E□□471MF11D		8,200	22×35	0.30	2,810	ESMG250E□□822MP35S	
	1,000	8×11.5	0.34	540	ESMG6R3E□□102MHB5D		10,000	22×40	0.34	3,240	ESMG250E□□103MP40S	
	2,200	10×20	0.36	1,000	ESMG6R3E□□222MJ20S		12,000	22×40	0.38	3,240	ESMG250E□□123MP40S	
	3,300	10×20	0.38	1,185	ESMG6R3E□□332MJ20S		35	47	5×11	0.14	130	ESMG350E□□470ME11D
	4,700	12.5×20	0.40	1,545	ESMG6R3E□□472MK20S			100	6.3×11	0.14	210	ESMG350E□□101MF11D
	6,800	12.5×25	0.44	1,915	ESMG6R3E□□682MK25S			220	8×11.5	0.14	385	ESMG350E□□221MHB5D
	10,000	16×25	0.52	2,330	ESMG6R3E□□103ML25S			330	10×12.5	0.14	490	ESMG350E□□331MJ20S
	10,000	20×25	0.46	2,310	ESMG6R3E□□103MN25S			470	10×16	0.14	645	ESMG350E□□471MJ16S
	15,000	16×35.5	0.62	2,845	ESMG6R3E□□153MLP1S			1,000	12.5×20	0.14	1,145	ESMG350E□□102MK20S
	15,000	20×30	0.56	2,660	ESMG6R3E□□153MN30S			2,200	16×25	0.16	1,785	ESMG350E□□222ML25S
	18,000	20×35	0.62	2,890	ESMG6R3E□□183MN35S			2,200	20×20	0.16	1,670	ESMG350E□□222MN20S
	18,000	22×30	0.62	2,860	ESMG6R3E□□183MP30S			3,300	16×35.5	0.18	2,275	ESMG350E□□332MLP1S
	22,000	18×40	0.76	3,320	ESMG6R3E□□223MM40S			3,300	20×25	0.18	2,050	ESMG350E□□332MN25S
22,000	20×40	0.70	3,130	ESMG6R3E□□223MN40S	3,900	20×30		0.18	2,310	ESMG350E□□392MN30S		
22,000	22×35	0.70	3,130	ESMG6R3E□□223MP35S	4,700	18×35.5		0.20	2,700	ESMG350E□□472MMP1S		
27,000	22×40	0.80	3,280	ESMG6R3E□□273MP40S	4,700	20×35		0.20	2,510	ESMG350E□□472MN35S		
10	220	5×11	0.24	240	ESMG100E□□221ME11D	4,700		22×30	0.20	2,380	ESMG350E□□472MP30S	
	330	6.3×11	0.24	290	ESMG100E□□331MF11D	5,600		20×40	0.22	2,690	ESMG350E□□562MN40S	
	470	6.3×11	0.24	350	ESMG100E□□471MF11D	5,600	22×35	0.22	2,690	ESMG350E□□562MP35S		
	1,000	10×12.5	0.24	650	ESMG100E□□102MJC5S	6,800	22×40	0.24	3,090	ESMG350E□□682MP40S		
	2,200	10×20	0.26	1,070	ESMG100E□□222MJ20S	50	1.0	5×11	0.12	17	ESMG500E□□1R0ME11D	
	3,300	12.5×20	0.28	1,420	ESMG100E□□332MK20S		2.2	5×11	0.12	28	ESMG500E□□2R2ME11D	
	4,700	12.5×25	0.30	1,780	ESMG100E□□472MK25S		3.3	5×11	0.12	35	ESMG500E□□3R3ME11D	
	6,800	16×25	0.34	2,220	ESMG100E□□682ML25S		4.7	5×11	0.12	41	ESMG500E□□4R7ME11D	
	6,800	20×20	0.34	2,080	ESMG100E□□682MN20S		10	5×11	0.12	60	ESMG500E□□100ME11D	
	10,000	16×35.5	0.42	2,670	ESMG100E□□103MLP1S		22	5×11	0.12	95	ESMG500E□□220ME11D	
	10,000	20×25	0.42	2,410	ESMG100E□□103MN25S		33	5×11	0.12	125	ESMG500E□□330ME11D	
	12,000	20×30	0.46	2,620	ESMG100E□□123MN30S		47	6.3×11	0.12	155	ESMG500E□□470MF11D	
	15,000	18×35.5	0.52	3,080	ESMG100E□□153MMP1S		100	8×11.5	0.12	260	ESMG500E□□101MHB5D	
	15,000	20×35	0.52	2,870	ESMG100E□□153MN35S		220	10×12.5	0.12	430	ESMG500E□□221MJ20S	
	15,000	22×30	0.52	2,660	ESMG100E□□153MP30S		330	10×16	0.12	585	ESMG500E□□331MJ16S	
18,000	22×35	0.58	3,050	ESMG100E□□183MP35S	470		10×20	0.12	755	ESMG500E□□471MJ20S		
22,000	22×40	0.66	3,480	ESMG100E□□223MP40S	1,000		12.5×25	0.12	1,340	ESMG500E□□102MK25S		
16	100	5×11	0.20	160	ESMG160E□□101ME11D		1,500	20×20	0.12	1,570	ESMG500E□□152MN20S	
	220	6.3×11	0.20	260	ESMG160E□□221MF11D		2,200	16×35.5	0.14	2,075	ESMG500E□□222MLP1S	
	330	8×11.5	0.20	370	ESMG160E□□331MHB5D	2,200	20×25	0.14	1,880	ESMG500E□□222MN25S		
	470	8×11.5	0.20	440	ESMG160E□□471MHB5D	2,700	20×30	0.14	2,150	ESMG500E□□272MN30S		
	1,000	10×16	0.20	785	ESMG160E□□102MJ16S	3,300	18×35.5	0.16	2,500	ESMG500E□□332MMP1S		
	2,200	12.5×20	0.22	1,295	ESMG160E□□222MK20S	3,300	20×35	0.16	2,420	ESMG500E□□332MN35S		
	3,300	12.5×25	0.24	1,655	ESMG160E□□332MK25S	3,300	22×30	0.16	2,420	ESMG500E□□332MP30S		
	4,700	16×25	0.26	2,090	ESMG160E□□472ML25S	3,900	20×40	0.16	2,590	ESMG500E□□392MN40S		
	4,700	20×20	0.26	1,960	ESMG160E□□472MN20S	3,900	22×35	0.16	2,590	ESMG500E□□392MP35S		
	6,800	16×31.5	0.30	2,520	ESMG160E□□682MLN3S	4,700	22×40	0.18	2,960	ESMG500E□□472MP40S		
	6,800	20×25	0.30	2,330	ESMG160E□□682MN25S	63	10	5×11	0.09	65	ESMG630E□□100ME11D	
	8,200	20×30	0.34	2,500	ESMG160E□□822MN30S		22	5×11	0.09	100	ESMG630E□□220ME11D	
	10,000	18×35.5	0.38	2,920	ESMG160E□□103MMP1S		33	6.3×11	0.09	140	ESMG630E□□330MF11D	
	10,000	20×35	0.38	2,720	ESMG160E□□103MN35S		47	6.3×11	0.09	170	ESMG630E□□470MF11D	
	10,000	22×30	0.38	2,660	ESMG160E□□103MP30S		100	10×12.5	0.09	300	ESMG630E□□101MJ20S	
12,000	20×40	0.42	2,900	ESMG160E□□123MN40S	220		10×16	0.09	490	ESMG630E□□221MJ16S		
12,000	22×35	0.42	2,900	ESMG160E□□123MP35S	330		10×20	0.09	710	ESMG630E□□331MJ20S		
15,000	22×40	0.48	3,380	ESMG160E□□153MP40S	470		12.5×20	0.09	900	ESMG630E□□471MK20S		
25	47	5×11	0.16	115	ESMG250E□□470ME11D		820	20×20	0.09	1,370	ESMG630E□□821MN20S	
	100	6.3×11	0.16	190	ESMG250E□□101MF11D		1,000	16×25	0.09	1,300	ESMG630E□□102ML25S	
	220	8×11.5	0.16	330	ESMG250E□□221MHB5D		1,000	20×25	0.09	1,600	ESMG630E□□102MN25S	
	330	8×11.5	0.16	440	ESMG250E□□331MHB5D		1,500	20×30	0.09	1,850	ESMG630E□□152MN30S	
	470	10×12.5	0.16	545	ESMG250E□□471MJ20S		2,200	20×35	0.11	2,330	ESMG630E□□222MN35S	
	1,000	10×20	0.16	955	ESMG250E□□102MJ20S		2,200	22×30	0.11	2,190	ESMG630E□□222MP30S	
	2,200	12.5×25	0.18	1,540	ESMG250E□□222MK25S		2,700	20×40	0.11	2,640	ESMG630E□□272MN40S	
	3,300	16×25	0.20	1,975	ESMG250E□□332ML25S	3,300	22×40	0.13	2,810	ESMG630E□□332MP40S		
	3,300	20×20	0.20	1,850	ESMG250E□□332MN20S	100	1.0	5×11	0.08	21	ESMG101E□□1R0ME11D	
	4,700	16×31.5	0.22	2,420	ESMG250E□□472MLN3S		2.2	5×11	0.08	30	ESMG101E□□2R2ME11D	
	4,700	20×25	0.22	2,420	ESMG250E□□472MN25S		3.3	5×11	0.08	40	ESMG101E□□3R3ME11D	
	5,600	20×30	0.24	2,430	ESMG250E□□562MN30S		4.7	5×11	0.08	45	ESMG101E□□4R7ME11D	
	6,800	18×35.5	0.26	2,880	ESMG250E□□682MMP1S		10	6.3×11	0.08	75	ESMG101E□□100MF11D	
	6,800	20×35	0.26	2,680	ESMG250E□□682MN35S		22	8×11.5	0.08	130	ESMG101E□□220MHB5D	

□□ : Enter the appropriate lead forming or taping code.

◆ STANDARD RATINGS

□□ is not solvent resistant.

WV (Vdc)	Cap (μF)	Case size φD×L(mm)	tanδ	Rated ripple current (mA _{RMS} /85°C, 120Hz)	Part No.	WV (Vdc)	Cap (μF)	Case size φD×L(mm)	tanδ	Rated ripple current (mA _{RMS} /85°C, 120Hz)	Part No.	
100	33	8×11.5	0.08	180	ESMG101E□□330MHB5D	315	47	20×20	0.15	310	ESMG3B1E□□470MN20S	
	47	10×12.5	0.08	230	ESMG101E□□470MJC5S		68	20×25	0.15	400	ESMG3B1E□□680MN25S	
	100	10×20	0.08	370	ESMG101E□□101MJ20S		82	20×25	0.15	440	ESMG3B1E□□820MN25S	
	220	12.5×25	0.08	620	ESMG101E□□221MK25S		100	20×30	0.15	500	ESMG3B1E□□101MN30S	
	330	12.5×25	0.08	760	ESMG101E□□331MK25S		120	20×30	0.15	550	ESMG3B1E□□121MN30S	
	330	20×20	0.08	870	ESMG101E□□331MN20S		180	20×40	0.15	720	ESMG3B1E□□181MN40S	
	470	16×25	0.08	1,000	ESMG101E□□471ML25S		180	22×35	0.15	720	ESMG3B1E□□181MP35S	
	680	20×30	0.08	1,360	ESMG101E□□681MN30S		220	22×40	0.15	810	ESMG3B1E□□221MP40S	
	820	22×30	0.08	1,540	ESMG101E□□821MP30S		350	1.0	6.3×11	0.24	22	ESMG351E□□1R0MF11D
	1,000	18×40	0.08	1,380	ESMG101E□□102MM40S			2.2	8×11.5	0.24	38	ESMG351E□□2R2MHB5D
	1,000	20×35	0.08	1,720	ESMG101E□□102MN35S			3.3	8×11.5	0.24	46	ESMG351E□□3R3MHB5D
	1,200	22×40	0.08	1,980	ESMG101E□□122MP40S			4.7	10×12.5	0.24	65	ESMG351E□□4R7MJC5S
160	3.3	6.3×11	0.20	40	ESMG161E□□3R3MF11D	10		10×20	0.24	115	ESMG351E□□100MJ20S	
	4.7	6.3×11	0.20	48	ESMG161E□□4R7MF11D	22		12.5×20	0.24	185	ESMG351E□□220MK20S	
	10	10×12.5	0.20	94	ESMG161E□□100MJC5S	33		16×25	0.24	275	ESMG351E□□330ML25S	
	22	10×20	0.20	170	ESMG161E□□220MJ20S	47		16×25	0.24	325	ESMG351E□□470ML25S	
	33	10×20	0.20	205	ESMG161E□□330MJ20S	47		20×20	0.15	310	ESMG351E□□470MN20S	
	47	12.5×20	0.20	270	ESMG161E□□471MK20S	68		20×25	0.15	400	ESMG351E□□680MN25S	
	100	12.5×25	0.20	430	ESMG161E□□101MK25S	100		18×31.5	0.24	530	ESMG351E□□101MMN3S	
	220	16×31.5	0.20	760	ESMG161E□□221MLN3S	100		20×30	0.15	500	ESMG351E□□101MN30S	
	220	20×25	0.15	730	ESMG161E□□221MN25S	120	20×35	0.15	560	ESMG351E□□121MN35S		
	330	18×35.5	0.20	995	ESMG161E□□331MMP1S	400	1.0	6.3×11	0.24	22	ESMG401E□□1R0MF11D	
	330	20×30	0.15	920	ESMG161E□□331MN30S		2.2	8×11.5	0.24	38	ESMG401E□□2R2MHB5D	
	390	20×35	0.15	1,160	ESMG161E□□391MN35S		3.3	10×12.5	0.24	54	ESMG401E□□3R3MJC5S	
390	22×30	0.15	1,160	ESMG161E□□391MP30S	4.7		10×16	0.24	71	ESMG401E□□4R7MJ16S		
470	20×40	0.15	1,340	ESMG161E□□471MN40S	10		10×20	0.24	115	ESMG401E□□100MJ20S		
470	22×35	0.15	1,340	ESMG161E□□471MP35S	22		12.5×25	0.24	205	ESMG401E□□220MK25S		
560	22×40	0.15	1,470	ESMG161E□□561MP40S	33		16×25	0.24	275	ESMG401E□□330ML25S		
200	3.3	6.3×11	0.20	40	ESMG201E□□3R3MF11D		33	20×20	0.15	260	ESMG401E□□330MN20S	
	4.7	8×11.5	0.20	55	ESMG201E□□4R7MHB5D		47	16×31.5	0.24	350	ESMG401E□□470MLN3S	
	10	10×12.5	0.20	94	ESMG201E□□100MJC5S		56	20×25	0.15	350	ESMG401E□□560MN25S	
	22	10×20	0.20	170	ESMG201E□□220MJ20S		68	20×30	0.15	420	ESMG401E□□680MN30S	
	33	10×20	0.20	205	ESMG201E□□330MJ20S		100	20×35	0.15	520	ESMG401E□□101MN35S	
	47	12.5×20	0.20	270	ESMG201E□□471MK20S	100	22×30	0.15	520	ESMG401E□□101MP30S		
	100	16×25	0.20	475	ESMG201E□□101ML25S	120	20×40	0.15	580	ESMG401E□□121MN40S		
	100	20×20	0.15	460	ESMG201E□□101MN20S	120	22×35	0.15	580	ESMG401E□□121MP35S		
	180	20×25	0.15	660	ESMG201E□□181MN25S	450	2.2	10×12.5	0.24	32	ESMG451E□□2R2MJC5S	
	220	18×35.5	0.20	810	ESMG201E□□221MMP1S		3.3	10×16	0.24	44	ESMG451E□□3R3MJ16S	
	220	20×30	0.15	750	ESMG201E□□221MN30S		4.7	10×20	0.24	56	ESMG451E□□4R7MJ20S	
	270	20×30	0.15	830	ESMG201E□□271MN30S		10	12.5×20	0.24	91	ESMG451E□□100MK20S	
330	20×35	0.15	1,070	ESMG201E□□331MN35S	22		16×25	0.24	165	ESMG451E□□220ML25S		
330	22×30	0.15	1,070	ESMG201E□□331MP30S	22		20×20	0.20	180	ESMG451E□□220MN20S		
390	20×40	0.15	1,190	ESMG201E□□391MN40S	33		16×31.5	0.24	215	ESMG451E□□330MLN3S		
390	22×30	0.15	1,160	ESMG201E□□391MP30S	33		20×25	0.20	240	ESMG451E□□330MN25S		
470	22×40	0.15	1,350	ESMG201E□□471MP40S	47		16×35.5	0.24	265	ESMG451E□□470MLP1S		
560	22×40	0.15	1,430	ESMG201E□□561MP40S	47		20×25	0.20	290	ESMG451E□□470MN25S		
250	2.2	6.3×11	0.20	32	ESMG251E□□2R2MF11D		56	20×30	0.20	320	ESMG451E□□560MN30S	
	3.3	8×11.5	0.20	46	ESMG251E□□3R3MHB5D		68	20×35	0.20	370	ESMG451E□□680MN35S	
	4.7	8×11.5	0.20	55	ESMG251E□□4R7MHB5D	68	22×30	0.20	370	ESMG451E□□680MP30S		
	10	10×16	0.20	105	ESMG251E□□100MJ16S	82	20×40	0.20	420	ESMG451E□□820MN40S		
	22	10×20	0.20	170	ESMG251E□□220MJ20S	82	22×35	0.20	420	ESMG451E□□820MP35S		
	33	12.5×20	0.20	230	ESMG251E□□330MK20S	100	22×40	0.20	470	ESMG451E□□101MP40S		
	47	12.5×25	0.20	295	ESMG251E□□470MK25S							
	82	20×20	0.15	420	ESMG251E□□820MN20S							
	100	16×31.5	0.20	515	ESMG251E□□101MLN3S							
	100	20×25	0.15	490	ESMG251E□□101MN25S							
	120	20×25	0.15	530	ESMG251E□□121MN25S							
	180	20×30	0.15	680	ESMG251E□□181MN30S							
220	18×40	0.20	825	ESMG251E□□221MM40S								
220	20×35	0.15	780	ESMG251E□□221MN35S								
220	22×30	0.15	820	ESMG251E□□221MP30S								
270	20×40	0.15	880	ESMG251E□□271MN40S								
270	22×35	0.15	880	ESMG251E□□271MP35S								
330	22×40	0.15	1,060	ESMG251E□□331MP40S								

□□ : Enter the appropriate lead forming or taping code.

◆ RATED RIPPLE CURRENT MULTIPLIERS

● Frequency Multipliers

(φ5 to φ18)

Capacitance (μF) \ Frequency (Hz)	50	120	300	1k	10k	100k
1.0 to 4.7	0.65	1.00	1.35	1.75	2.30	2.50
10 to 47	0.75	1.00	1.25	1.50	1.75	1.80
100 to 1,000	0.80	1.00	1.15	1.30	1.40	1.50
2,200 to	0.85	1.00	1.03	1.05	1.08	1.08

(φ20, φ22)

Rated Voltage (V _o) \ Frequency (Hz)	50	120	300	1k	10k	100k
6.3 to 50	0.95	1.00	1.03	1.05	1.08	1.08
63 to 100	0.92	1.00	1.07	1.13	1.19	1.20
160 to 250	0.81	1.00	1.17	1.32	1.45	1.50
315 to 450	0.77	1.00	1.16	1.30	1.41	1.43

The endurance of capacitors is reduced with internal heating produced by ripple current at the rate of halving the lifetime with every 5°C rise. When long life performance is required in actual use, the rms ripple current has to be reduced.

KMG Series

- Endurance with ripple current : 1,000 to 2,000 hours at 105°C
- Solvent resistant type except 350 to 450V_{dc}
(see PRECAUTIONS AND GUIDELINES)
- RoHS Compliant



◆ SPECIFICATIONS

Items	Characteristics																						
Category Temperature Range	-55 to +105°C(6.3 to 100V _{dc}) -40 to +105°C(160 to 400V _{dc}) -25 to +105°C(450V _{dc})																						
Rated Voltage Range	6.3 to 450V _{dc}																						
Capacitance Tolerance	±20% (M) (at 20°C, 120Hz)																						
Leakage Current	6.3 to 100V _{dc}																						
	I=0.03CV or 4µA, whichever is greater.																						
	160 to 450V _{dc}																						
	<table border="1"> <thead> <tr> <th>CV</th> <th>Time</th> <th>After 1minute</th> <th>After 5minutes</th> </tr> </thead> <tbody> <tr> <td>CV≤1,000</td> <td></td> <td>I=0.1CV+40 max.</td> <td>I=0.03CV+15 max.</td> </tr> <tr> <td>CV>1,000</td> <td></td> <td>I=0.04CV+100 max.</td> <td>I=0.02CV+25 max.</td> </tr> </tbody> </table>												CV	Time	After 1minute	After 5minutes	CV≤1,000		I=0.1CV+40 max.	I=0.03CV+15 max.	CV>1,000		I=0.04CV+100 max.
CV	Time	After 1minute	After 5minutes																				
CV≤1,000		I=0.1CV+40 max.	I=0.03CV+15 max.																				
CV>1,000		I=0.04CV+100 max.	I=0.02CV+25 max.																				
(at 20°C after 1 minute) (at 20°C)																							
Where, I : Max. leakage current (µA), C : Nominal capacitance (µF), V : Rated voltage (V)																							
Dissipation Factor (tanδ)	Rated voltage (V _{dc})	6.3V	10V	16V	25V	35V	50V	63V	100V	160 to 250V	350 to 400V	450V											
	tanδ (Max.)	0.34	0.24	0.20	0.16	0.14	0.12	0.10	0.08	0.20	0.24	0.24											
	When nominal capacitance exceeds 1,000µF, add 0.02 to the value above for each 1,000µF increase. (at 20°C, 120Hz)																						
Low Temperature Characteristics (Max. Impedance Ratio)	Rated voltage (V _{dc})	6.3V	10V	16V	25V	35V	50V	63V	100V	160 to 250V	350 to 400V	450V											
	Z(-25°C)/Z(+20°C)	5	4	3	2	2	2	2	2	3	6	6											
	Z(-40°C)/Z(+20°C)	12	10	8	5	4	3	3	3	4	6	—											
(at 120Hz)																							
Endurance	The following specifications shall be satisfied when the capacitors are restored to 20°C after subjected to DC voltage with the rated ripple current is applied (the peak voltage shall not exceed the rated voltage) for 1,000 hours (2,000 hours to meet the following two conditions 1): 160V _{dc} and larger, 2) : φ12.5 and larger) at 105°C.																						
	Capacitance change	≤ ±20% of the initial value																					
	D.F. (tanδ)	≤200% of the initial specified value																					
	Leakage current	≤ The initial specified value																					
Shelf Life	The following specifications shall be satisfied when the capacitors are restored to 20°C after exposing them for 1,000 hours at 105°C without voltage applied. Before the measurement, the capacitor shall be preconditioned by applying voltage according to Item 4.1 of JIS C 5101-4.																						
	Rated voltage	6.3 to 100V _{cd}						160 to 450V _{dc}															
	Capacitance change	≤ ±20% of the initial value						≤ ±20% of the initial value															
	D.F. (tanδ)	≤200% of the initial specified value						≤200% of the initial specified value															
	Leakage current	≤ The initial specified value						≤500% of the initial specified value															

◆ DIMENSIONS [mm]

- Terminal Code : E

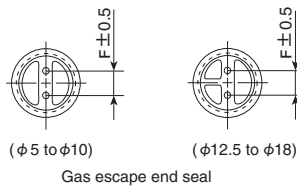
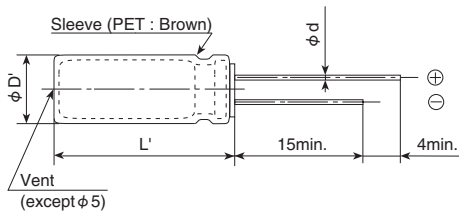

φD	5	6.3	8	10	12.5	16	18
φd	0.5	0.5	0.6	0.6	0.6	0.8	0.8
F	2.0	2.5	3.5	5.0	5.0	7.5	7.5
φD'	φD+0.5max						
L'	L+1.5max						

◆ PART NUMBERING SYSTEM

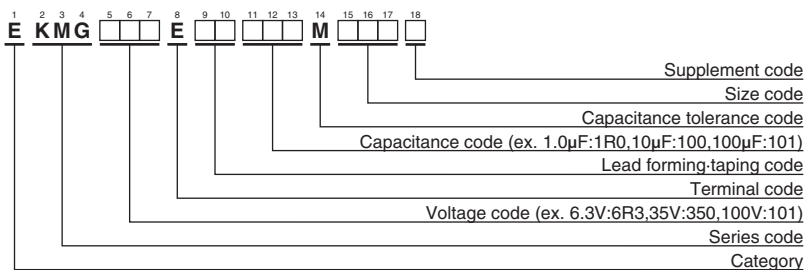

Please refer to "Product code guide (radial lead type)"

◆STANDARD RATINGS

WV (Vdc)	Cap (μF)	Case size φD×L(mm)	tanδ	Rated ripple current (mA rms/105°C, 120Hz)	Part No.	WV (Vdc)	Cap (μF)	Case size φD×L(mm)	tanδ	Rated ripple current (mA rms/105°C, 120Hz)	Part No.
6.3	220	5X11	0.34	140	EKMG6R3E□□221ME11D	63	10	5X11	0.10	46	EKMG630E□□100ME11D
	330	6.3X11	0.34	190	EKMG6R3E□□331MF11D		22	5X11	0.10	71	EKMG630E□□220ME11D
	470	6.3X11	0.34	230	EKMG6R3E□□471MF11D		33	6.3X11	0.10	100	EKMG630E□□330MF11D
	1,000	8X11.5	0.34	380	EKMG6R3E□□102MHB5D		47	6.3X11	0.10	120	EKMG630E□□470MF11D
	2,200	10X20	0.36	710	EKMG6R3E□□222MJ20S		100	10X12.5	0.10	215	EKMG630E□□101MJC5S
	3,300	10X20	0.38	840	EKMG6R3E□□332MJ20S		220	10X16	0.10	335	EKMG630E□□221MJ16S
	4,700	12.5X20	0.40	1,090	EKMG6R3E□□472MK20S		330	10X20	0.10	510	EKMG630E□□331MJ20S
	6,800	12.5X25	0.44	1,350	EKMG6R3E□□682MK25S		470	12.5X20	0.10	640	EKMG630E□□471MK20S
	10,000	16X25	0.52	1,650	EKMG6R3E□□103ML25S		1,000	16X25	0.10	930	EKMG630E□□102ML25S
	15,000	16X35.5	0.62	2,010	EKMG6R3E□□153MLP1S		1.0	5X11	0.08	15	EKMG101E□□1R0ME11D
	22,000	18X40	0.76	2,350	EKMG6R3E□□223MM40S		2.2	5X11	0.08	21	EKMG101E□□2R2ME11D
10	220	6.3X11	0.24	170	EKMG100E□□221MF11D	3.3	5X11	0.08	29	EKMG101E□□3R3ME11D	
	330	6.3X11	0.24	200	EKMG100E□□331MF11D	4.7	5X11	0.08	32	EKMG101E□□4R7ME11D	
	470	8X11.5	0.24	250	EKMG100E□□471MHB5D	10	6.3X11	0.08	54	EKMG101E□□100MF11D	
	1,000	10X12.5	0.24	460	EKMG100E□□102MJC5S	22	8X11.5	0.08	93	EKMG101E□□220MHB5D	
	2,200	10X20	0.26	760	EKMG100E□□222MJ20S	33	8X11.5	0.08	130	EKMG101E□□330MHB5D	
	3,300	12.5X20	0.28	1,000	EKMG100E□□332MK20S	47	10X12.5	0.08	165	EKMG101E□□470MJC5S	
	4,700	12.5X25	0.30	1,260	EKMG100E□□472MK25S	100	10X20	0.08	265	EKMG101E□□101MJ20S	
	6,800	16X25	0.34	1,570	EKMG100E□□682ML25S	220	12.5X25	0.08	440	EKMG101E□□221MK25S	
	10,000	16X35.5	0.42	1,890	EKMG100E□□103MLP1S	330	16X25	0.08	540	EKMG101E□□331ML25S	
	15,000	18X35.5	0.52	2,180	EKMG100E□□153MMP1S	470	16X31.5	0.08	715	EKMG101E□□471MLN3S	
16	100	5X11	0.20	110	EKMG160E□□101ME11D	1,000	18X40	0.08	985	EKMG101E□□102MM40S	
	220	6.3X11	0.20	180	EKMG160E□□221MF11D	3.3	6.3X11	0.20	28	EKMG161E□□3R3MF11D	
	330	8X11.5	0.20	260	EKMG160E□□331MHB5D	4.7	6.3X11	0.20	34	EKMG161E□□4R7MF11D	
	470	8X11.5	0.20	310	EKMG160E□□471MHB5D	10	10X12.5	0.20	67	EKMG161E□□100MJC5S	
	1,000	10X16	0.20	560	EKMG160E□□102MJ16S	22	10X20	0.20	120	EKMG161E□□220MJ20S	
	2,200	12.5X20	0.22	920	EKMG160E□□222MK20S	33	10X20	0.20	145	EKMG161E□□330MJ20S	
	3,300	12.5X25	0.24	1,170	EKMG160E□□332MK25S	47	12.5X20	0.20	195	EKMG161E□□470MK20S	
	4,700	16X25	0.26	1,480	EKMG160E□□472ML25S	100	16X25	0.20	335	EKMG161E□□101ML25S	
	6,800	16X31.5	0.30	1,780	EKMG160E□□682MLN3S	220	16X31.5	0.20	540	EKMG161E□□221MLN3S	
	10,000	18X35.5	0.38	2,060	EKMG160E□□103MMP1S	330	18X35.5	0.20	705	EKMG161E□□331MMP1S	
25	47	5X11	0.16	80	EKMG250E□□470ME11D	3.3	6.3X11	0.20	28	EKMG201E□□3R3MF11D	
	100	6.3X11	0.16	130	EKMG250E□□101MF11D	4.7	8X11.5	0.20	39	EKMG201E□□4R7MHB5D	
	220	8X11.5	0.16	230	EKMG250E□□221MHB5D	10	10X16	0.20	74	EKMG201E□□100MJ16S	
	330	8X11.5	0.16	310	EKMG250E□□331MHB5D	22	10X20	0.20	120	EKMG201E□□220MJ20S	
	470	10X12.5	0.16	380	EKMG250E□□471MJC5S	33	12.5X20	0.20	160	EKMG201E□□330MK20S	
	1,000	10X20	0.16	680	EKMG250E□□102MJ20S	47	12.5X20	0.20	195	EKMG201E□□470MK20S	
	2,200	12.5X25	0.18	1,090	EKMG250E□□222MK25S	100	16X25	0.20	335	EKMG201E□□101ML25S	
	3,300	16X25	0.20	1,400	EKMG250E□□332ML25S	220	18X35.5	0.20	575	EKMG201E□□221MMP1S	
	4,700	16X31.5	0.22	1,710	EKMG250E□□472MLN3S	2.2	6.3X11	0.20	23	EKMG251E□□2R2MF11D	
	6,800	18X35.5	0.26	2,040	EKMG250E□□682MMP1S	3.3	8X11.5	0.20	32	EKMG251E□□3R3MHB5D	
35	47	5X11	0.14	90	EKMG350E□□470ME11D	4.7	8X11.5	0.20	39	EKMG251E□□4R7MHB5D	
	100	6.3X11	0.14	150	EKMG350E□□101MF11D	10	10X16	0.20	74	EKMG251E□□100MJ16S	
	220	8X11.5	0.14	270	EKMG350E□□221MHB5D	22	12.5X20	0.20	130	EKMG251E□□220MK20S	
	330	10X12.5	0.14	350	EKMG350E□□331MJC5S	33	12.5X20	0.20	160	EKMG251E□□330MK20S	
	470	10X16	0.14	460	EKMG350E□□471MJ16S	47	12.5X25	0.20	210	EKMG251E□□470MK25S	
	1,000	12.5X20	0.14	810	EKMG350E□□102MK20S	100	16X31.5	0.20	365	EKMG251E□□101MLN3S	
	2,200	16X25	0.16	1,260	EKMG350E□□222ML25S	220	18X40	0.20	585	EKMG251E□□221MM40S	
	3,300	16X35.5	0.18	1,610	EKMG350E□□332MLP1S	1.0	6.3X11	0.24	15	EKMG351E□□1R0MF11D	
	4,700	18X35.5	0.20	1,910	EKMG350E□□472MMP1S	2.2	8X11.5	0.24	26	EKMG351E□□2R2MHB5D	
	50	1.0	5X11	0.12	13	EKMG500E□□1R0ME11D	3.3	10X12.5	0.24	38	EKMG351E□□3R3MJC5S
2.2		5X11	0.12	20	EKMG500E□□2R2ME11D	4.7	10X16	0.24	50	EKMG351E□□4R7MJ16S	
3.3		5X11	0.12	25	EKMG500E□□3R3ME11D	10	10X20	0.24	80	EKMG351E□□100MJ20S	
4.7		5X11	0.12	30	EKMG500E□□4R7ME11D	22	12.5X20	0.24	130	EKMG351E□□220MK20S	
10		5X11	0.12	40	EKMG500E□□100ME11D	33	16X25	0.24	195	EKMG351E□□330ML25S	
22		5X11	0.12	65	EKMG500E□□220ME11D	47	16X25	0.24	230	EKMG351E□□470ML25S	
33		5X11	0.12	90	EKMG500E□□330ME11D	100	18X31.5	0.24	375	EKMG351E□□101MLN3S	
47		6.3X11	0.12	110	EKMG500E□□470MF11D	1.0	6.3X11	0.24	15	EKMG401E□□1R0MF11D	
100		8X11.5	0.12	180	EKMG500E□□101MHB5D	2.2	8X11.5	0.24	26	EKMG401E□□2R2MHB5D	
220		10X12.5	0.12	300	EKMG500E□□221MJC5S	3.3	10X12.5	0.24	38	EKMG401E□□3R3MJC5S	
330		10X16	0.12	410	EKMG500E□□331MJ16S	4.7	10X16	0.24	50	EKMG401E□□4R7MJ16S	
470		10X20	0.12	530	EKMG500E□□471MJ20S	10	10X20	0.24	80	EKMG401E□□100MJ20S	
1,000		12.5X25	0.12	950	EKMG500E□□102MK25S	22	12.5X25	0.24	145	EKMG401E□□220MK25S	
2,200	16X35.5	0.14	1,470	EKMG500E□□222MLP1S	33	16X25	0.24	195	EKMG401E□□330ML25S		
3,300	18X35.5	0.16	1,770	EKMG500E□□332MMP1S	47	16X31.5	0.24	250	EKMG401E□□470MLN3S		
100	10	5X11	0.10	46	EKMG630E□□100ME11D	100	16X40	0.24	350	EKMG401E□□101ML40S	
	22	5X11	0.10	71	EKMG630E□□220ME11D						
	33	6.3X11	0.10	100	EKMG630E□□330MF11D						
	47	6.3X11	0.10	120	EKMG630E□□470MF11D						
	100	10X12.5	0.10	215	EKMG630E□□101MJC5S						
	220	10X16	0.10	335	EKMG630E□□221MJ16S						
	330	10X20	0.10	510	EKMG630E□□331MJ20S						
	470	12.5X20	0.10	640	EKMG630E□□471MK20S						
	1,000	16X25	0.10	930	EKMG630E□□102ML25S						
	1.0	5X11	0.08	15	EKMG101E□□1R0ME11D						
	2.2	5X11	0.08	21	EKMG101E□□2R2ME11D						
	3.3	5X11	0.08	29	EKMG101E□□3R3ME11D						
	4.7	5X11	0.08	32	EKMG101E□□4R7ME11D						
10	6.3X11	0.08	54	EKMG101E□□100MF11D							
22	8X11.5	0.08	93	EKMG101E□□220MHB5D							
33	8X11.5	0.08	130	EKMG101E□□330MHB5D							
47	10X12.5	0.08	165	EKMG101E□□470MJC5S							
100	10X20	0.08	265	EKMG101E□□101MJ20S							
220	12.5X25	0.08	440	EKMG101E□□221MK25S							
330	16X25	0.08	540	EKMG101E□□331ML25S							
470	16X31.5	0.08	715	EKMG101E□□471MLN3S							
1,000	18X40	0.08	985	EKMG101E□□102MM40S							
3.3	6.3X11	0.20	28	EKMG161E□□3R3MF11D							
4.7	6.3X11	0.20	34	EKMG161E□□4R7MF11D							
10	10X12.5	0.20	67	EKMG161E□□100MJC5S							
22	10X20	0.20	120	EKMG161E□□220MJ20S							
33	10X20	0.20	145	EKMG161E□□330MJ20S							
47	12.5X20	0.20	195	EKMG161E□□470MK20S							
100	16X25	0.20	335	EKMG161E□□101ML25S							
220	16X31.5	0.20	540	EKMG161E□□221MLN3S							
330	18X35.5	0.20	705	EKMG161E□□331MMP1S							
3.3	6.3X11	0.20	28	EKMG201E□□3R3MF11D							
4.7	8X11.5	0.20	39	EKMG201E□□4R7MHB5D							
10	10X16	0.20	74	EKMG201E□□100MJ16S							
22	10X20	0.20	120	EKMG201E□□220MJ20S							
33	12.5X20	0.20	160	EKMG201E□□330MK20S							
47	12.5X20	0.20	195	EKMG201E□□470MK20S							



KMG Series

◆STANDARD RATINGS

is not solvent resistant.

WV (Vdc)	Cap (μF)	Case size φD×L(mm)	tanδ	Rated ripple current (mA _{rms} /105°C,120Hz)	Part No.
450	2.2	10×12.5	0.24	23	EKMG451E□□2R2MJC5S
	3.3	10×16	0.24	31	EKMG451E□□3R3MJ16S
	4.7	10×20	0.24	40	EKMG451E□□4R7MJ20S
	10	12.5×20	0.24	65	EKMG451E□□100MK20S
	22	16×25	0.24	115	EKMG451E□□220ML25S
	33	16×31.5	0.24	155	EKMG451E□□330MLN3S
	47	16×35.5	0.24	185	EKMG451E□□470MLP1S

□□ : Enter the appropriate lead forming or taping code.

◆RATED RIPPLE CURRENT MULTIPLIERS

●Frequency Multipliers

Capacitance (μF)	Frequency (Hz)					
	50	120	300	1k	10k	100k
1.0 to 4.7	0.65	1.00	1.35	1.75	2.30	2.50
10 to 47	0.75	1.00	1.25	1.50	1.75	1.80
100 to 1,000	0.80	1.00	1.15	1.30	1.40	1.50
2,200 to	0.85	1.00	1.03	1.05	1.08	1.08

The endurance of capacitors is reduced with internal heating produced by ripple current at the rate of halving the lifetime with every 5°C rise. When long life performance is required in actual use, the rms ripple current has to be reduced.

SME-BP Series

- Standard Bi-polar type
- Endurance : 2,000 hours at 85°C
- Solvent resistant type (see PRECAUTIONS AND GUIDELINES)
- RoHS Compliant



◆ SPECIFICATIONS

Items	Characteristics										
Category Temperature Range	-40 to +85°C										
Rated Voltage Range	6.3 to 100V _{dc}										
Capacitance Tolerance	±20% (M) (at 20°C, 120Hz)										
Leakage Current	I=0.06CV or 10μA, whichever is greater. (at 20°C after 2 minutes) I=0.03CV or 3μA, whichever is greater. (at 20°C after 5 minutes) Where, I : Max. leakage current (μA), C : Nominal capacitance (μF), V : Rated voltage (V)										
Dissipation Factor (tanδ)	Rated voltage (V _{dc})	6.3V	10V	16V	25V	35V	50V	63V	80V	100V	
	tanδ (Max.)	0.24	0.24	0.20	0.20	0.16	0.14	0.12	0.12	0.10	
	When nominal capacitance exceeds 1,000μF, add 0.02 to the value above for each 1,000μF increase. (at 20°C, 120Hz)										
Low Temperature Characteristics (Max. Impedance Ratio)	Rated voltage (V _{dc})	6.3V	10V	16V	25V	35V	50V	63V	80V	100V	
	Z(-25°C)/Z(+20°C)	4	3	2	2	2	2	2	2	2	
	Z(-40°C)/Z(+20°C)	10	8	6	4	3	3	3	3	3	
Endurance	The following specifications shall be satisfied when the capacitors are restored to 20°C after the rated voltage is applied for 2,000 hours at 85°C, however the polarization shall be reversed every 250 hours.										
	Rated voltage	6.3 to 16V _{dc}					25 to 100V _{dc}				
	Capacitance change	≤ ±25% of the initial value					≤ ±20% of the initial value				
	D.F. (tanδ)	≤ 150% of the initial specified value									
	Leakage current	≤ The initial specified value									
Shelf Life	The following specifications shall be satisfied when the capacitors are restored to 20°C after exposing them for 1,000 hours at 85°C without voltage applied. Before the measurement, the capacitor shall be preconditioned by applying voltage according to Item 4.1 of JIS C 5101-4.										
	Rated voltage	6.3 to 16V _{dc}					25 to 100V _{dc}				
	Capacitance change	≤ ±25% of the initial value					≤ ±20% of the initial value				
	D.F. (tanδ)	≤ 150% of the initial specified value									
	Leakage current	≤ The initial specified value									

◆ DIMENSIONS [mm]

- Terminal Code : E

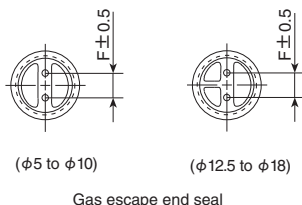
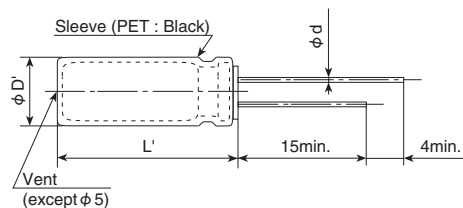

φD	5	6.3	8	10	12.5	16	18
φd	0.5	0.5	0.6	0.6	0.6	0.8	0.8
F	2.0	2.5	3.5	5.0	5.0	7.5	7.5
φD'	φD+0.5max.						
L'	L+1.5max.						

◆ PART NUMBERING SYSTEM

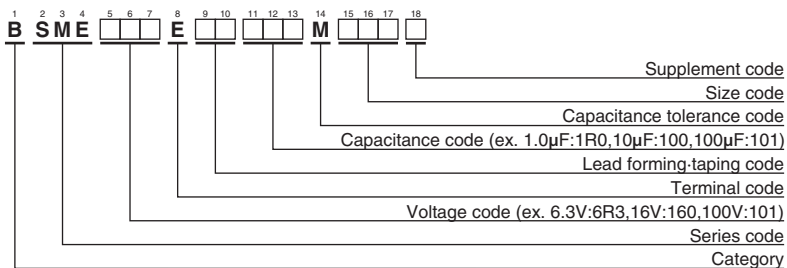

Please refer to "Product code guide (radial lead type)"

SME-BP Series

◆STANDARD RATINGS

WV (Vdc)	Cap (μF)	Case size φD×L(mm)	tanδ	Rated ripple current (mA _{rms} /85°C, 120Hz)	Part No.	WV (Vdc)	Cap (μF)	Case size φD×L(mm)	tanδ	Rated ripple current (mA _{rms} /85°C, 120Hz)	Part No.	
6.3	33	5×11	0.24	64	BSME6R3E□□330ME11D	35	100	10×16	0.16	230	BSME350E□□101MJ16S	
	47	5×11	0.24	76	BSME6R3E□□470ME11D		220	12.5×20	0.16	410	BSME350E□□221MK20S	
	100	6.3×11	0.24	125	BSME6R3E□□101MF11D		330	12.5×20	0.16	505	BSME350E□□331MK20S	
	220	8×11.5	0.24	215	BSME6R3E□□221MHB5D		470	12.5×25	0.16	655	BSME350E□□471MK25S	
	330	8×11.5	0.24	265	BSME6R3E□□331MHB5D		1,000	16×31.5	0.16	1,140	BSME350E□□102MLN3S	
	470	10×12.5	0.24	370	BSME6R3E□□471MJC5S		50	1.0	5×11	0.14	17	BSME500E□□1R0ME11D
	1,000	10×20	0.24	650	BSME6R3E□□102MJ20S			2.2	5×11	0.14	25	BSME500E□□2R2ME11D
	2,200	12.5×25	0.26	1,160	BSME6R3E□□222MK25S			3.3	5×11	0.14	27	BSME500E□□3R3ME11D
	3,300	16×25	0.28	1,570	BSME6R3E□□332ML25S			4.7	5×11	0.14	34	BSME500E□□4R7ME11D
	4,700	16×31.5	0.30	2,020	BSME6R3E□□472MLN3S			10	6.3×11	0.14	52	BSME500E□□100MF11D
6,800	18×35.5	0.34	2,600	BSME6R3E□□682MMP1S	22	8×11.5		0.14	89	BSME500E□□220MHB5D		
10	22	5×11	0.24	57	BSME100E□□220ME11D	33		8×11.5	0.14	105	BSME500E□□330MHB5D	
	33	5×11	0.24	64	BSME100E□□330ME11D	47		10×12.5	0.14	150	BSME500E□□470MJC5S	
	47	5×11	0.24	76	BSME100E□□470ME11D	100		10×20	0.14	265	BSME500E□□101MJ20S	
	100	6.3×11	0.24	125	BSME100E□□101MF11D	220		12.5×25	0.14	480	BSME500E□□221MK25S	
	220	8×11.5	0.24	215	BSME100E□□221MHB5D	330	16×25	0.14	650	BSME500E□□331ML25S		
	330	10×16	0.24	345	BSME100E□□331MJ16S	470	16×31.5	0.14	835	BSME500E□□471MLN3S		
	470	10×16	0.24	410	BSME100E□□471MJ16S	63	3.3	5×11	0.12	28	BSME630E□□3R3ME11D	
	1,000	12.5×20	0.24	720	BSME100E□□102MK20S		4.7	6.3×11	0.12	34	BSME630E□□4R7MF11D	
	2,200	16×25	0.26	1,280	BSME100E□□222ML25S		10	6.3×11	0.12	57	BSME630E□□100MF11D	
	3,300	16×31.5	0.28	1,690	BSME100E□□332MLN3S		22	8×11.5	0.12	95	BSME630E□□220MHB5D	
4,700	18×35.5	0.30	2,160	BSME100E□□472MMP1S	33		10×12.5	0.12	135	BSME630E□□330MJC5S		
16	10	5×11	0.20	42	BSME160E□□100ME11D		47	10×16	0.12	180	BSME630E□□470MJ16S	
	22	5×11	0.20	57	BSME160E□□220ME11D		100	12.5×20	0.12	320	BSME630E□□101MK20S	
	33	5×11	0.20	70	BSME160E□□330ME11D		220	16×25	0.12	575	BSME630E□□221ML25S	
	47	6.3×11	0.20	95	BSME160E□□470MF11D		330	16×31.5	0.12	655	BSME630E□□331MLN3S	
	100	8×11.5	0.20	160	BSME160E□□101MHB5D		470	18×35.5	0.12	965	BSME630E□□471MMP1S	
	220	10×12.5	0.20	275	BSME160E□□221MJC5S	80	2.2	5×11	0.12	29	BSME800E□□2R2ME11D	
	330	10×16	0.20	375	BSME160E□□331MJ16S		3.3	6.3×11	0.12	39	BSME800E□□3R3MF11D	
	470	10×20	0.20	485	BSME160E□□471MJ20S		4.7	6.3×11	0.12	47	BSME800E□□4R7MF11D	
	1,000	12.5×25	0.20	855	BSME160E□□102MK25S		10	8×11.5	0.12	65	BSME800E□□100MHB5D	
	2,200	16×31.5	0.22	1,510	BSME160E□□222MLN3S		22	10×16	0.12	125	BSME800E□□220MJ16S	
3,300	18×35.5	0.24	1,980	BSME160E□□332MMP1S	33		10×16	0.12	150	BSME800E□□330MJ16S		
25	10	5×11	0.20	42	BSME250E□□100ME11D		47	10×20	0.12	195	BSME800E□□470MJC5S	
	22	6.3×11	0.20	65	BSME250E□□220MF11D		100	12.5×25	0.12	350	BSME800E□□101MK25S	
	33	6.3×11	0.20	80	BSME250E□□330MF11D		220	16×31.5	0.12	615	BSME800E□□221MLN3S	
	47	6.3×11	0.20	95	BSME250E□□470MF11D		330	18×35.5	0.12	755	BSME800E□□331MMP1S	
	100	8×11.5	0.20	160	BSME250E□□101MHB5D	100	1.0	5×11	0.10	21	BSME101E□□1R0ME11D	
	220	10×16	0.20	305	BSME250E□□221MJ16S		2.2	6.3×11	0.10	34	BSME101E□□2R2MF11D	
	330	12.5×20	0.20	450	BSME250E□□331MK20S		3.3	6.3×11	0.10	39	BSME101E□□3R3MF11D	
	470	12.5×20	0.20	540	BSME250E□□471MK20S		4.7	6.3×11	0.10	47	BSME101E□□4R7MF11D	
	1,000	16×25	0.20	950	BSME250E□□102ML25S		10	8×11.5	0.10	71	BSME101E□□100MHB5D	
	2,200	18×35.5	0.22	1,620	BSME250E□□222MMP1S		22	10×16	0.10	135	BSME101E□□220MJ16S	
35	4.7	5×11	0.16	34	BSME350E□□4R7ME11D		33	12.5×20	0.10	220	BSME101E□□330MK20S	
	10	5×11	0.16	43	BSME350E□□100ME11D		47	12.5×20	0.10	240	BSME101E□□470MK20S	
	22	6.3×11	0.16	73	BSME350E□□220MF11D		100	16×25	0.10	425	BSME101E□□101ML25S	
	33	8×11.5	0.16	100	BSME350E□□330MHB5D		220	18×35.5	0.10	720	BSME101E□□221MMP1S	
	47	8×11.5	0.16	120	BSME350E□□470MHB5D							

□□ : Enter the appropriate lead forming or taping code.

◆RATED RIPPLE CURRENT MULTIPLIERS

●Frequency Multipliers

Capacitance (μF)	Frequency (Hz)					
	50	120	300	1k	10k	100k
1.0 to 4.7	0.65	1.00	1.35	1.75	2.30	2.50
10 to 47	0.75	1.00	1.25	1.50	1.75	1.80
100 to 1,000	0.80	1.00	1.15	1.30	1.40	1.50
2,200 to	0.85	1.00	1.03	1.05	1.08	1.08

The endurance of capacitors is reduced with internal heating produced by ripple current at the rate of halving the lifetime with every 5°C rise. When long life performance is required in actual use, the rms ripple current has to be reduced.

KME-BP Series



- Standard Bi-polar type
- Endurance : 1,000 hours at 105°C
- Solvent resistant type (see PRECAUTIONS AND GUIDELINES)
- RoHS Compliant

◆ SPECIFICATIONS

Items	Characteristics										
Category	-55 to +105°C										
Temperature Range											
Rated Voltage Range	6.3 to 100V _{dc}										
Capacitance Tolerance	±20% (M) (at 20°C, 120Hz)										
Leakage Current	I=0.06CV or 10µA, whichever is greater. (at 20°C after 2 minutes) I=0.03CV or 3µA, whichever is greater. (at 20°C after 5 minutes) Where, I : Max. leakage current (µA), C : Nominal capacitance (µF), V : Rated voltage (V)										
Dissipation Factor (tanδ)	Rated voltage (V _{dc})	6.3V	10V	16V	25V	35V	50V	63V	80V	100V	
	tanδ (Max.)	0.24	0.24	0.20	0.20	0.16	0.14	0.12	0.12	0.10	
	When nominal capacitance exceeds 1,000µF, add 0.02 to the value above for each 1,000µF increase. (at 20°C, 120Hz)										
Low Temperature Characteristics (Max. Impedance Ratio)	Rated voltage (V _{dc})	6.3V	10V	16V	25V	35V	50V	63V	80V	100V	
	Z(-25°C)/Z(+20°C)	4	3	2	2	2	2	2	2	2	
	Z(-40°C)/Z(+20°C)	10	8	6	4	3	3	3	3	3	
Endurance	The following specifications shall be satisfied when the capacitors are restored to 20°C after the rated voltage is applied for 1,000 hours at 105°C, however the polarization shall be reversed every 250 hours.										
	Rated voltage	6.3 to 16V _{dc}					25 to 100V _{dc}				
	Capacitance change	≤ ±25% of the initial value					≤ ±20% of the initial value				
	D.F. (tanδ)	≤ 150% of the initial specified value									
	Leakage current	≤ The initial specified value									
Shelf Life	The following specifications shall be satisfied when the capacitors are restored to 20°C after exposing them for 500 hours at 105°C without voltage applied. Before the measurement, the capacitor shall be preconditioned by applying voltage according to Item 4.1 of JIS C 5101-4.										
	Rated voltage	6.3 to 16V _{dc}					25 to 100V _{dc}				
	Capacitance change	≤ ±25% of the initial value					≤ ±20% of the initial value				
	D.F. (tanδ)	≤ 150% of the initial specified value									
	Leakage current	≤ The initial specified value									

◆ DIMENSIONS [mm]

- Terminal Code : E

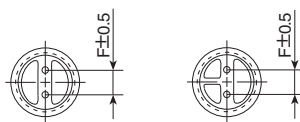
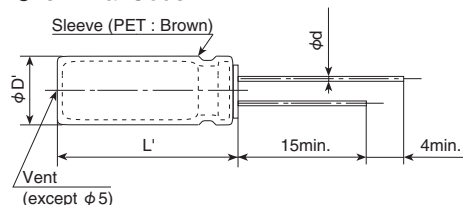

Gas escape end seal

φD	5	6.3	8	10	12.5	16	18
φd	0.5	0.5	0.6	0.6	0.6	0.8	0.8
F	2.0	2.5	3.5	5.0	5.0	7.5	7.5
φD'	φD+0.5max.						
L'	L+1.5max.						

◆ PART NUMBERING SYSTEM

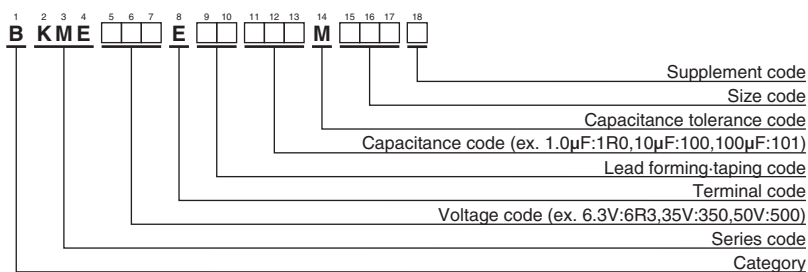

Please refer to "Product code guide (radial lead type)"

KME-BP Series

◆STANDARD RATINGS

WV (Vdc)	Cap (μF)	Case size φD×L(mm)	tanδ	Rated ripple current (mA _{rms} /105°C, 120Hz)	Part No.	WV (Vdc)	Cap (μF)	Case size φD×L(mm)	tanδ	Rated ripple current (mA _{rms} /105°C, 120Hz)	Part No.	
6.3	33	5×11	0.24	45	BKME6R3E□□330ME11D	35	100	10×16	0.16	160	BKME350E□□101MJ16S	
	47	5×11	0.24	54	BKME6R3E□□470ME11D		220	12.5×20	0.16	290	BKME350E□□221MK20S	
	100	6.3×11	0.24	90	BKME6R3E□□101MF11D		330	12.5×20	0.16	350	BKME350E□□331MK20S	
	220	8×11.5	0.24	150	BKME6R3E□□221MHB5D		470	12.5×25	0.16	465	BKME350E□□471MK25S	
	330	8×11.5	0.24	185	BKME6R3E□□331MHB5D		1,000	16×31.5	0.16	805	BKME350E□□102MLN3S	
	470	10×12.5	0.24	260	BKME6R3E□□471MJC5S		50	1.0	5×11	0.14	10	BKME500E□□1R0ME11D
	1,000	10×20	0.24	460	BKME6R3E□□102MJ20S			2.2	5×11	0.14	15	BKME500E□□2R2ME11D
	2,200	12.5×25	0.26	820	BKME6R3E□□222MK25S			3.3	5×11	0.14	18	BKME500E□□3R3ME11D
	3,300	16×25	0.28	1,110	BKME6R3E□□332ML25S			4.7	5×11	0.14	22	BKME500E□□4R7ME11D
	4,700	16×31.5	0.30	1,430	BKME6R3E□□472MLN3S			10	6.3×11	0.14	37	BKME500E□□100MF11D
6,800	18×35.5	0.34	1,830	BKME6R3E□□682MMP1S	22	8×11.5		0.14	63	BKME500E□□220MHB5D		
10	22	5×11	0.24	37	BKME100E□□220ME11D	33		8×11.5	0.14	77	BKME500E□□330MHB5D	
	33	5×11	0.24	45	BKME100E□□330ME11D	47		10×12.5	0.14	105	BKME500E□□470MJC5S	
	47	5×11	0.24	54	BKME100E□□470ME11D	100		10×20	0.14	190	BKME500E□□101MJ20S	
	100	6.3×11	0.24	90	BKME100E□□101MF11D	220		12.5×25	0.14	340	BKME500E□□221MK25S	
	220	8×11.5	0.24	150	BKME100E□□221MHB5D	330	16×25	0.14	460	BKME500E□□331ML25S		
	330	10×16	0.24	240	BKME100E□□331MJ16S	470	16×31.5	0.14	590	BKME500E□□471MLN3S		
	470	10×16	0.24	290	BKME100E□□471MJ16S	63	3.3	5×11	0.12	20	BKME630E□□3R3ME11D	
	1,000	12.5×20	0.24	510	BKME100E□□102MK20S		4.7	6.3×11	0.12	24	BKME630E□□4R7MF11D	
	2,200	16×25	0.26	910	BKME100E□□222ML25S		10	6.3×11	0.12	40	BKME630E□□100MF11D	
	3,300	16×31.5	0.28	1,200	BKME100E□□332MLN3S		22	8×11.5	0.12	68	BKME630E□□220MHB5D	
4,700	18×35.5	0.30	1,520	BKME100E□□472MMP1S	33		10×12.5	0.12	98	BKME630E□□330MJC5S		
16	10	5×11	0.20	27	BKME160E□□100ME11D		47	10×16	0.12	130	BKME630E□□470MJ16S	
	22	5×11	0.20	40	BKME160E□□220ME11D		100	12.5×20	0.12	225	BKME630E□□101MK20S	
	33	5×11	0.20	49	BKME160E□□330ME11D		220	16×25	0.12	405	BKME630E□□221ML25S	
	47	6.3×11	0.20	67	BKME160E□□470MF11D		330	16×31.5	0.12	535	BKME630E□□331MLN3S	
	100	8×11.5	0.20	110	BKME160E□□101MHB5D		470	18×35.5	0.12	680	BKME630E□□471MMP1S	
	220	10×12.5	0.20	195	BKME160E□□221MJC5S	80	2.2	5×11	0.12	16	BKME800E□□2R2ME11D	
	330	10×16	0.20	265	BKME160E□□331MJ16S		3.3	6.3×11	0.12	23	BKME800E□□3R3MF11D	
	470	10×20	0.20	345	BKME160E□□471MJ20S		4.7	6.3×11	0.12	27	BKME800E□□4R7MF11D	
	1,000	12.5×25	0.20	605	BKME160E□□102MK25S		10	8×11.5	0.12	46	BKME800E□□100MHB5D	
	2,200	16×31.5	0.22	1,070	BKME160E□□222MLN3S		22	10×16	0.12	89	BKME800E□□220MJ16S	
3,300	18×35.5	0.24	1,400	BKME160E□□332MMP1S	33		10×16	0.12	105	BKME800E□□330MJ16S		
25	10	5×11	0.20	27	BKME250E□□100ME11D		47	10×20	0.12	140	BKME800E□□470MJC5S	
	22	6.3×11	0.20	46	BKME250E□□220MF11D		100	12.5×25	0.12	245	BKME800E□□101MK25S	
	33	6.3×11	0.20	56	BKME250E□□330MF11D		220	16×31.5	0.12	435	BKME800E□□221MLN3S	
	47	6.3×11	0.20	67	BKME250E□□470MF11D		330	18×35.5	0.12	570	BKME800E□□331MMP1S	
	100	8×11.5	0.20	110	BKME250E□□101MHB5D	100	1.0	5×11	0.10	12	BKME101E□□1R0ME11D	
	220	10×16	0.20	215	BKME250E□□221MJ16S		2.2	6.3×11	0.10	20	BKME101E□□2R2MF11D	
	330	12.5×20	0.20	320	BKME250E□□331MK20S		3.3	6.3×11	0.10	25	BKME101E□□3R3MF11D	
	470	12.5×20	0.20	380	BKME250E□□471MK20S		4.7	6.3×11	0.10	30	BKME101E□□4R7MF11D	
	1,000	16×25	0.20	670	BKME250E□□102ML25S		10	8×11.5	0.10	50	BKME101E□□100MHB5D	
	2,200	18×35.5	0.22	1,140	BKME250E□□222MMP1S		22	10×16	0.10	97	BKME101E□□220MJ16S	
35	4.7	5×11	0.16	21	BKME350E□□4R7ME11D		33	12.5×20	0.10	140	BKME101E□□330MK20S	
	10	5×11	0.16	30	BKME350E□□100ME11D		47	12.5×20	0.10	170	BKME101E□□470MK20S	
	22	6.3×11	0.16	51	BKME350E□□220MF11D		100	16×25	0.10	300	BKME101E□□101ML25S	
	33	8×11.5	0.16	72	BKME350E□□330MHB5D		220	18×35.5	0.10	510	BKME101E□□221MMP1S	
	47	8×11.5	0.16	86	BKME350E□□470MHB5D							

□□ : Enter the appropriate lead forming or taping code.

◆RATED RIPPLE CURRENT MULTIPLIERS

●Frequency Multipliers

Capacitance (μF)	Frequency (Hz)					
	50	120	300	1k	10k	100k
1.0 to 4.7	0.65	1.00	1.35	1.75	2.30	2.50
10 to 47	0.75	1.00	1.25	1.50	1.75	1.80
100 to 1,000	0.80	1.00	1.15	1.30	1.40	1.50
2,200 to	0.85	1.00	1.03	1.05	1.08	1.08

The endurance of capacitors is reduced with internal heating produced by ripple current at the rate of halving the lifetime with every 5°C rise. When long life performance is required in actual use, the rms ripple current has to be reduced.

New!

KZN Series

- Adoption of innovative high stability electrolyte
- High ripple current and long endurance
- Rated voltage range : 6.3 to 100V_{dc}, Capacitance range : 56 to 22,000μF
- Endurance with ripple current : 9,000 to 10,000 hours at 105°C
- Non solvent resistant type
- RoHS Compliant



◆ SPECIFICATIONS

Items	Characteristics									
Category	-40 to +105°C									
Temperature Range										
Rated Voltage Range	6.3 to 100V _{dc}									
Capacitance Tolerance	±20% (M) (at 20°C, 120Hz)									
Leakage Current	I=0.01CV Where, I : Max. leakage current (μA), C : Nominal capacitance (μF), V : Rated voltage (V) (at 20°C after 2 minutes)									
Dissipation Factor (tanδ)	Rated voltage (V _{dc})	6.3V	10V	16V	25V	35V	50V	63V	80V	100V
	tanδ (Max.)	0.22	0.19	0.16	0.14	0.12	0.10	0.09	0.09	0.08
When nominal capacitance exceeds 1,000μF, add 0.02 to the value above for each 1,000μF increase. (at 20°C, 120Hz)										
Low Temperature Characteristics	Z(-25°C)/Z(+20°C)	2 max.								
	Z(-40°C)/Z(+20°C)	3 max.								
(at 120Hz)										
Endurance	The following specifications shall be satisfied when the capacitors are restored to 20°C after subjected to DC voltage with the rated ripple current is applied (the peak voltage shall not exceed the rated voltage) for 10,000 hours (9,000 hours for 12.5L max.) at 105°C.									
	Capacitance change	≤ ±25% of the initial value (6.3, 10V _{dc} : ≤ ±30%)								
	D.F. (tanδ)	≤ 200% of the initial specified value								
	Leakage current	≤ The initial specified value								
Shelf Life	The following specifications shall be satisfied when the capacitors are restored to 20°C after exposing them for 500 hours at 105°C without voltage applied. Before the measurement, the capacitor shall be preconditioned by applying voltage according to Item 4.1 of JIS C 5101-4.									
	Capacitance change	≤ ±25% of the initial value (6.3, 10V _{dc} : ≤ ±30%)								
	D.F. (tanδ)	≤ 200% of the initial specified value								
	Leakage current	≤ The initial specified value								

◆ DIMENSIONS [mm]

- Terminal Code : E

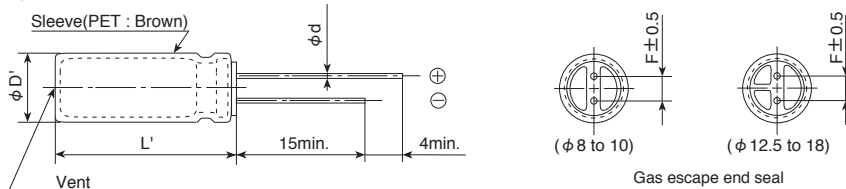

φD	8	10	12.5	16	18
φd	0.6	0.6	0.6	0.8	0.8
F	3.5	5.0	5.0	7.5	7.5
D'	φD + 0.5max.				
L'	L + 1.5max.				

◆ PART NUMBERING SYSTEM

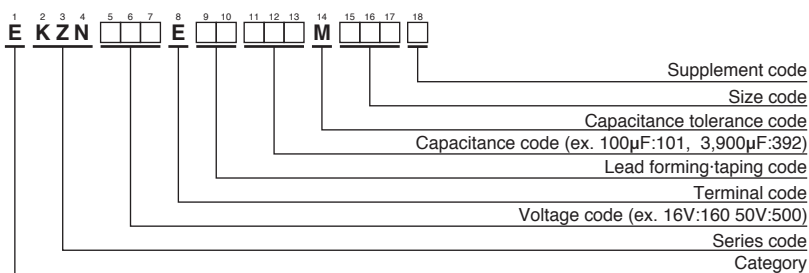

Please refer to "Product code guide (radial lead type)"

◆ RATED RIPPLE CURRENT MULTIPLIERS

- Frequency Multipliers

Capacitance (μF)	Frequency (Hz)			
	120	1k	10k	100k
56 to 180	0.40	0.75	0.90	1.00
220 to 560	0.50	0.85	0.94	1.00
680 to 1,800	0.60	0.87	0.95	1.00
2,200 to 3,900	0.75	0.90	0.95	1.00
4,700 to 22,000	0.85	0.95	0.98	1.00

Note : The endurance of capacitors is reduced with internal heating produced by ripple current at the rate of halving the lifetime with every 5°C rise. When long life performance is required in actual use, the rms ripple current has to be reduced.

New!

KZN Series

◆ STANDARD RATINGS

WV (Vdc)	Cap (μF)	Case size φD×L(mm)	Impedance (Ωmax/100kHz)		Rated ripple current (mA _{RMS} /105°C, 100kHz)	Part No.	WV (Vdc)	Cap (μF)	Case size φD×L(mm)	Impedance (Ωmax/100kHz)		Rated ripple current (mA _{RMS} /105°C, 100kHz)	Part No.
			20°C	-10°C						20°C	-10°C		
6.3	1,200	10×12.5	0.053	0.16	1,330	EKZN6R3E□□122MJCS5	25	680	10×16	0.038	0.12	2,000	EKZN250E□□681MJ16S
	1,800	10×16	0.038	0.12	1,760	EKZN6R3E□□182MJ16S		820	10×20	0.028	0.084	2,500	EKZN250E□□821MJ20S
	2,700	10×20	0.028	0.084	1,960	EKZN6R3E□□272MJ20S		1,000	12.5×16	0.035	0.11	2,400	EKZN250E□□102MK16S
	2,700	12.5×16	0.035	0.11	1,900	EKZN6R3E□□272MK16S		1,200	10×25	0.026	0.072	2,900	EKZN250E□□122MJ25S
	3,300	10×25	0.026	0.072	2,250	EKZN6R3E□□332MJ25S		1,500	12.5×20	0.025	0.075	2,600	EKZN250E□□152MK20S
	3,900	12.5×20	0.025	0.075	2,480	EKZN6R3E□□392MK20S		1,800	12.5×25	0.019	0.057	3,200	EKZN250E□□182MK25S
	5,600	12.5×25	0.019	0.057	2,900	EKZN6R3E□□562MK25S		2,200	12.5×30	0.018	0.054	3,660	EKZN250E□□222MK30S
	6,800	12.5×30	0.018	0.054	3,450	EKZN6R3E□□682MK30S		2,200	16×20	0.021	0.063	3,330	EKZN250E□□222ML20S
	6,800	16×20	0.021	0.063	3,250	EKZN6R3E□□682ML20S		2,700	12.5×35	0.016	0.048	4,120	EKZN250E□□272MK35S
	8,200	12.5×35	0.016	0.048	3,570	EKZN6R3E□□822MK35S		3,300	16×25	0.017	0.051	3,810	EKZN250E□□332ML25S
	8,200	18×20	0.020	0.060	3,450	EKZN6R3E□□822MM20S		3,300	18×20	0.020	0.060	3,450	EKZN250E□□332MM20S
	10,000	16×25	0.017	0.051	3,630	EKZN6R3E□□103ML25S		4,700	16×31.5	0.016	0.048	4,100	EKZN250E□□472MLN3S
	12,000	16×31.5	0.016	0.048	4,100	EKZN6R3E□□123MLN3S		4,700	18×25	0.016	0.048	3,880	EKZN250E□□472MM25S
	12,000	18×25	0.016	0.048	3,880	EKZN6R3E□□123MM25S		5,600	16×35.5	0.014	0.042	4,280	EKZN250E□□562MLP1S
	15,000	16×35.5	0.014	0.042	4,280	EKZN6R3E□□153MLP1S		5,600	18×31.5	0.014	0.042	4,190	EKZN250E□□562MMN3S
	15,000	18×31.5	0.014	0.042	4,190	EKZN6R3E□□153MMN3S		6,800	16×40	0.013	0.039	4,580	EKZN250E□□682ML40S
	18,000	16×40	0.013	0.039	4,580	EKZN6R3E□□183ML40S		6,800	18×35.5	0.012	0.036	4,380	EKZN250E□□682MMP1S
	18,000	18×35.5	0.012	0.036	4,380	EKZN6R3E□□183MMP1S		8,200	18×40	0.011	0.033	4,960	EKZN250E□□822MM40S
22,000	18×40	0.011	0.033	4,960	EKZN6R3E□□223MM40S	35	180	8×11.5	0.075	0.23	1,200	EKZN350E□□181MHB5D	
1,000	10×12.5	0.053	0.16	1,700	EKZN100E□□102MJCS5		220	8×15	0.059	0.18	1,600	EKZN350E□□221MH15D	
1,200	10×16	0.038	0.12	2,000	EKZN100E□□122MJ16S		270	10×12.5	0.053	0.16	1,700	EKZN350E□□271MJCS5	
1,800	10×20	0.028	0.084	2,500	EKZN100E□□182MJ20S		330	8×20	0.041	0.13	1,960	EKZN350E□□331MH20D	
1,800	12.5×16	0.035	0.11	2,400	EKZN100E□□182MK16S		390	10×16	0.038	0.12	2,000	EKZN350E□□391MJ16S	
2,200	10×25	0.026	0.072	2,900	EKZN100E□□222MJ25S		470	10×20	0.028	0.084	2,500	EKZN350E□□471MJ20S	
2,700	12.5×20	0.025	0.075	2,600	EKZN100E□□272MK20S		560	12.5×16	0.035	0.11	2,400	EKZN350E□□561MK16S	
3,900	12.5×25	0.019	0.057	3,200	EKZN100E□□392MK25S		680	10×25	0.026	0.072	2,900	EKZN350E□□681MJ25S	
4,700	12.5×30	0.018	0.054	3,660	EKZN100E□□472MK30S		820	12.5×20	0.025	0.075	2,600	EKZN350E□□821MK20S	
4,700	16×20	0.021	0.063	3,330	EKZN100E□□472ML20S		1,200	12.5×25	0.019	0.057	3,200	EKZN350E□□122MK25S	
5,600	12.5×35	0.016	0.048	4,120	EKZN100E□□562MK35S		1,500	12.5×30	0.018	0.054	3,660	EKZN350E□□152MK30S	
5,600	18×20	0.020	0.060	3,450	EKZN100E□□562MM20S		1,500	16×20	0.021	0.063	3,330	EKZN350E□□152ML20S	
6,800	16×25	0.017	0.051	3,810	EKZN100E□□682ML25S		1,800	12.5×35	0.016	0.048	4,120	EKZN350E□□182MK35S	
8,200	16×31.5	0.016	0.048	4,100	EKZN100E□□822MLN3S		1,800	16×25	0.017	0.051	3,810	EKZN350E□□182ML25S	
8,200	18×25	0.016	0.048	3,880	EKZN100E□□822MM25S		1,800	18×20	0.020	0.060	3,450	EKZN350E□□182MM20S	
10,000	16×35.5	0.014	0.042	4,280	EKZN100E□□103MLP1S		2,700	16×31.5	0.016	0.048	4,100	EKZN350E□□272MLN3S	
10,000	18×31.5	0.014	0.042	4,190	EKZN100E□□103MMN3S		2,700	18×25	0.016	0.048	3,880	EKZN350E□□272MM25S	
12,000	16×40	0.013	0.039	4,580	EKZN100E□□123ML40S		3,300	16×35.5	0.014	0.042	4,280	EKZN350E□□332MLP1S	
12,000	18×35.5	0.012	0.036	4,380	EKZN100E□□123MMP1S	3,300	18×31.5	0.014	0.042	4,190	EKZN350E□□332MMN3S		
15,000	18×40	0.011	0.033	4,960	EKZN100E□□153MM40S	3,900	16×40	0.013	0.039	4,580	EKZN350E□□392ML40S		
16	470	8×11.5	0.075	0.23	1,200	EKZN160E□□471MHB5D	3,900	18×35.5	0.012	0.036	4,380	EKZN350E□□392MMP1S	
	680	8×15	0.059	0.18	1,600	EKZN160E□□681MH15D	4,700	18×40	0.011	0.033	4,960	EKZN350E□□472MM40S	
	680	10×12.5	0.053	0.16	1,700	EKZN160E□□681MJCS5	50	100	8×11.5	0.085	0.26	1,200	EKZN500E□□101MHB5D
	820	8×20	0.041	0.13	1,960	EKZN160E□□821MH20D		120	8×15	0.065	0.20	1,600	EKZN500E□□121MH15D
	1,000	10×16	0.038	0.12	2,000	EKZN160E□□102MJ16S		150	10×12.5	0.073	0.22	1,280	EKZN500E□□151MJCS5
	1,500	10×20	0.028	0.084	2,500	EKZN160E□□152MJ20S		180	8×20	0.049	0.16	1,960	EKZN500E□□181MH20D
	1,500	12.5×16	0.035	0.11	2,400	EKZN160E□□152MK16S		220	10×16	0.053	0.16	1,650	EKZN500E□□221MJ16S
	1,800	10×25	0.026	0.072	2,900	EKZN160E□□182MJ25S		330	10×20	0.038	0.12	2,060	EKZN500E□□331MJ20S
	2,200	12.5×20	0.025	0.075	2,600	EKZN160E□□222MK20S		330	12.5×16	0.045	0.14	2,160	EKZN500E□□331MK16S
	2,700	12.5×25	0.019	0.057	3,200	EKZN160E□□272MK25S		390	10×25	0.032	0.10	2,420	EKZN500E□□391MJ25S
	3,300	12.5×30	0.018	0.054	3,660	EKZN160E□□332MK30S		470	12.5×20	0.032	0.10	2,300	EKZN500E□□471MK20S
	3,900	12.5×35	0.016	0.048	4,120	EKZN160E□□392MK35S		680	12.5×25	0.025	0.080	2,800	EKZN500E□□681MK25S
	3,900	16×20	0.021	0.063	3,330	EKZN160E□□392ML20S		820	12.5×30	0.023	0.074	3,370	EKZN500E□□821MK30S
	4,700	18×20	0.020	0.060	3,450	EKZN160E□□472MM20S		820	16×20	0.026	0.084	3,070	EKZN500E□□821ML20S
	5,600	16×25	0.017	0.051	3,810	EKZN160E□□562ML25S		1,000	12.5×35	0.021	0.067	3,810	EKZN500E□□102MK35S
	6,800	16×31.5	0.016	0.048	4,100	EKZN160E□□682MLN3S		1,200	16×25	0.022	0.070	3,510	EKZN500E□□122ML25S
	6,800	18×25	0.016	0.048	3,880	EKZN160E□□682MM25S		1,200	18×20	0.025	0.075	3,120	EKZN500E□□122MM20S
	8,200	16×35.5	0.014	0.042	4,280	EKZN160E□□822MLP1S		1,500	16×31.5	0.019	0.057	4,030	EKZN500E□□152MLN3S
8,200	18×31.5	0.014	0.042	4,190	EKZN160E□□822MMN3S	1,500		18×25	0.021	0.063	3,530	EKZN500E□□152MM25S	
10,000	16×40	0.013	0.039	4,580	EKZN160E□□103ML40S	1,800		16×35.5	0.016	0.048	4,220	EKZN500E□□182MLP1S	
10,000	18×35.5	0.012	0.036	4,380	EKZN160E□□103MMP1S	2,200	16×40	0.014	0.042	4,500	EKZN500E□□222ML40S		
12,000	18×40	0.011	0.033	4,960	EKZN160E□□123MM40S	2,200	18×31.5	0.016	0.048	4,080	EKZN500E□□222MMN3S		
25	270	8×11.5	0.075	0.23	1,200	EKZN250E□□271MHB5D	2,700	18×35.5	0.013	0.039	4,270	EKZN500E□□272MMP1S	
	470	8×15	0.059	0.18	1,600	EKZN250E□□471MH15D	3,300	18×40	0.012	0.036	4,850	EKZN500E□□332MM40S	
	470	10×12.5	0.053	0.16	1,700	EKZN250E□□471MJCS5	63	120	10×12.5	0.090	0.36	990	EKZN630E□□121MJCS5
	560	8×20	0.041	0.13	1,960	EKZN250E□□561MH20D		180	10×16	0.061	0.25	1,200	EKZN630E□□181MJ16S

□□ : Enter the appropriate lead forming or taping code.

New!

KZN Series

◆ STANDARD RATINGS

WV (Vdc)	Cap (μF)	Case size φD×L(mm)	Impedance (Ωmax/100kHz)		Rated ripple current (mA _{rms} /105°C, 100kHz)	Part No.	WV (Vdc)	Cap (μF)	Case size φD×L(mm)	Impedance (Ωmax/100kHz)		Rated ripple current (mA _{rms} /105°C, 100kHz)	Part No.	
			20°C	-10°C						20°C	-10°C			
63	270	10×20	0.045	0.18	1,570	EKZN630E□□271MJ20S	80	680	18×20	0.032	0.096	2,270	EKZN800E□□681MM20S	
	270	12.5×16	0.058	0.18	1,570	EKZN630E□□271MK16S		820	16×31.5	0.022	0.066	2,640	EKZN800E□□821MLN3S	
	330	10×25	0.037	0.12	1,990	EKZN630E□□331MJ25S		820	18×25	0.027	0.081	2,500	EKZN800E□□821MM25S	
	390	12.5×20	0.033	0.10	1,990	EKZN630E□□391MK20S		1,000	16×35.5	0.020	0.060	2,860	EKZN800E□□102MLP1S	
	560	12.5×25	0.026	0.080	2,460	EKZN630E□□561MK25S		1,200	16×40	0.018	0.054	3,510	EKZN800E□□122ML40S	
	680	12.5×30	0.024	0.075	2,760	EKZN630E□□681MK30S		1,200	18×31.5	0.020	0.060	2,860	EKZN800E□□122MMN3S	
	680	16×20	0.027	0.085	2,380	EKZN630E□□681ML20S		1,500	18×35.5	0.018	0.054	3,510	EKZN800E□□152MMP1S	
	820	12.5×35	0.022	0.068	3,040	EKZN630E□□821MK35S		1,800	18×40	0.017	0.051	3,860	EKZN800E□□182MM40S	
	820	18×20	0.026	0.078	2,530	EKZN630E□□821MM20S		100	56	10×12.5	0.14	0.56	780	EKZN101E□□560MJC5S
	1,000	16×25	0.024	0.072	2,890	EKZN630E□□102ML25S			82	10×16	0.090	0.36	1,040	EKZN101E□□820MJ16S
	1,200	16×31.5	0.020	0.060	3,280	EKZN630E□□122MLN3S			100	10×20	0.068	0.28	1,430	EKZN101E□□101MJ20S
	1,200	18×25	0.022	0.066	2,930	EKZN630E□□122MM25S			120	12.5×16	0.090	0.27	1,430	EKZN101E□□121MK16S
	1,500	16×35.5	0.018	0.054	3,440	EKZN630E□□152MLP1S			150	10×25	0.055	0.22	1,620	EKZN101E□□151MJ25S
	1,500	18×31.5	0.018	0.054	3,380	EKZN630E□□152MMN3S			180	12.5×20	0.048	0.15	1,750	EKZN101E□□181MK20S
	1,800	16×40	0.016	0.048	3,690	EKZN630E□□182ML40S			220	12.5×25	0.038	0.12	2,210	EKZN101E□□221MK25S
	1,800	18×35.5	0.017	0.051	3,550	EKZN630E□□182MMP1S			270	12.5×30	0.033	0.11	2,400	EKZN101E□□271MK30S
2,200	18×40	0.015	0.045	3,930	EKZN630E□□222MM40S	270	16×20		0.036	0.12	1,950	EKZN101E□□271ML20S		
80	82	10×12.5	0.14	0.56	780	EKZN800E□□820MJC5S	390		12.5×35	0.026	0.078	2,600	EKZN101E□□391MK35S	
	120	10×16	0.090	0.36	1,040	EKZN800E□□121MJ16S	390		16×25	0.028	0.084	2,430	EKZN101E□□391ML25S	
	180	10×20	0.068	0.28	1,430	EKZN800E□□181MJ20S	390		18×20	0.032	0.096	2,270	EKZN101E□□391MM20S	
	180	12.5×16	0.090	0.27	1,430	EKZN800E□□181MK16S	470		16×31.5	0.022	0.066	2,640	EKZN101E□□471MLN3S	
	220	10×25	0.055	0.22	1,620	EKZN800E□□221MJ25S	560		16×35.5	0.020	0.060	2,860	EKZN101E□□561MLP1S	
	270	12.5×20	0.048	0.15	1,750	EKZN800E□□271MK20S	560		18×25	0.027	0.081	2,500	EKZN101E□□561MM25S	
	390	12.5×25	0.038	0.12	2,210	EKZN800E□□391MK25S	680		16×40	0.018	0.054	3,510	EKZN101E□□681ML40S	
	470	12.5×30	0.033	0.11	2,400	EKZN800E□□471MK30S	680	18×31.5	0.020	0.060	2,860	EKZN101E□□681MMN3S		
	470	16×20	0.036	0.12	1,950	EKZN800E□□471ML20S	820	18×35.5	0.018	0.054	3,510	EKZN101E□□821MMP1S		
	560	12.5×35	0.026	0.078	2,600	EKZN800E□□561MK35S	1,000	18×40	0.017	0.051	3,860	EKZN101E□□102MM40S		
	680	16×25	0.028	0.084	2,430	EKZN800E□□681ML25S								

□□ : Enter the appropriate lead forming or taping code.

◆STANDARD RATINGS

WV (Vdc)	Cap (μF)	Case size φD×L(mm)	tanδ	Impedance (Ωmax/100kHz)		Rated ripple current (mA rms/105°C, 100kHz)	Part No.
				20°C	-10°C		
6.3	220	5 × 11	0.22	0.22	0.80	345	EKZM6R3E□□221ME11D
	470	6.3 × 11	0.22	0.094	0.35	540	EKZM6R3E□□471MF11D
	820	8 × 11.5	0.22	0.056	0.19	945	EKZM6R3E□□821MHB5D
	1,200	8 × 15	0.22	0.045	0.15	1,250	EKZM6R3E□□122MH15D
	1,200	10 × 12.5	0.22	0.039	0.14	1,330	EKZM6R3E□□122MJC5S
	1,500	8 × 20	0.22	0.029	0.11	1,500	EKZM6R3E□□152MH20D
	1,800	10 × 16	0.22	0.028	0.10	1,760	EKZM6R3E□□182MJ16S
	2,200	10 × 20	0.24	0.020	0.060	1,960	EKZM6R3E□□222MJ20S
	2,700	10 × 25	0.24	0.018	0.054	2,250	EKZM6R3E□□272MJ25S
	3,900	12.5 × 20	0.26	0.017	0.043	2,480	EKZM6R3E□□392MK20S
	4,700	12.5 × 25	0.28	0.015	0.038	2,900	EKZM6R3E□□472MK25S
	5,600	12.5 × 30	0.30	0.013	0.033	3,450	EKZM6R3E□□562MK30S
	6,800	12.5 × 35	0.32	0.012	0.031	3,570	EKZM6R3E□□682MK35S
10	150	5 × 11	0.19	0.22	0.80	345	EKZM100E□□151ME11D
	330	6.3 × 11	0.19	0.094	0.35	540	EKZM100E□□331MF11D
	680	8 × 11.5	0.19	0.056	0.19	945	EKZM100E□□681MHB5D
	1,000	8 × 15	0.19	0.045	0.15	1,250	EKZM100E□□102MH15D
	1,000	10 × 12.5	0.19	0.039	0.14	1,330	EKZM100E□□102MJC5S
	1,500	8 × 20	0.19	0.029	0.11	1,500	EKZM100E□□152MH20D
	1,500	10 × 16	0.19	0.028	0.10	1,760	EKZM100E□□152MJ16S
	1,800	10 × 20	0.19	0.020	0.060	1,960	EKZM100E□□182MJ20S
	2,200	10 × 25	0.21	0.018	0.054	2,250	EKZM100E□□222MJ25S
	3,300	12.5 × 20	0.23	0.017	0.043	2,480	EKZM100E□□332MK20S
	3,900	12.5 × 25	0.23	0.015	0.038	2,900	EKZM100E□□392MK25S
	4,700	12.5 × 30	0.25	0.013	0.033	3,450	EKZM100E□□472MK30S
	4,700	16 × 20	0.25	0.015	0.038	3,250	EKZM100E□□472ML20S
5,600	12.5 × 35	0.27	0.012	0.031	3,570	EKZM100E□□562MK35S	
6,800	16 × 25	0.29	0.013	0.035	3,630	EKZM100E□□682ML25S	
8,200	18 × 25	0.33	0.012	0.031	3,650	EKZM100E□□822MM25S	
16	100	5 × 11	0.16	0.22	0.80	345	EKZM160E□□101ME11D
	220	6.3 × 11	0.16	0.094	0.35	540	EKZM160E□□221MF11D
	470	8 × 11.5	0.16	0.056	0.19	945	EKZM160E□□471MHB5D
	680	8 × 15	0.16	0.045	0.15	1,250	EKZM160E□□681MH15D
	680	10 × 12.5	0.16	0.039	0.14	1,330	EKZM160E□□681MJC5S
	1,000	8 × 20	0.16	0.029	0.11	1,500	EKZM160E□□102MH20D
	1,000	10 × 16	0.16	0.028	0.10	1,760	EKZM160E□□102MJ16S
	1,500	10 × 20	0.16	0.020	0.060	1,960	EKZM160E□□152MJ20S
	1,800	10 × 25	0.16	0.018	0.054	2,250	EKZM160E□□182MJ25S
	2,200	12.5 × 20	0.18	0.017	0.043	2,480	EKZM160E□□222MK20S
	2,700	12.5 × 25	0.18	0.015	0.038	2,900	EKZM160E□□272MK25S
	3,300	12.5 × 30	0.20	0.013	0.033	3,450	EKZM160E□□332MK30S
	3,300	16 × 20	0.20	0.015	0.038	3,250	EKZM160E□□332ML20S
	3,900	12.5 × 35	0.20	0.012	0.031	3,570	EKZM160E□□392MK35S
	4,700	16 × 25	0.22	0.013	0.035	3,630	EKZM160E□□472ML25S
	5,600	18 × 25	0.24	0.012	0.031	3,650	EKZM160E□□562MM25S

□□ : Enter the appropriate lead forming or taping code.

◆STANDARD RATINGS

WV (V _{dc})	Cap (μF)	Case size ΦD×L(mm)	tanδ	Impedance (Ω _{max} /100kHz)		Rated ripple current (mA _{rms} /105°C,100kHz)	Part No.
				20°C	-10°C		
25	68	5 × 11	0.14	0.22	0.80	345	EKZM250E□□680ME11D
	150	6.3 × 11	0.14	0.094	0.35	540	EKZM250E□□151MF11D
	330	8 × 11.5	0.14	0.056	0.19	945	EKZM250E□□331MHB5D
	390	8 × 15	0.14	0.045	0.15	1,250	EKZM250E□□391MH15D
	470	10 × 12.5	0.14	0.039	0.14	1,330	EKZM250E□□471MJC5S
	560	8 × 20	0.14	0.029	0.11	1,500	EKZM250E□□561MH20D
	680	10 × 16	0.14	0.028	0.10	1,760	EKZM250E□□681MJ16S
	820	10 × 20	0.14	0.020	0.060	1,960	EKZM250E□□821MJ20S
	1,000	10 × 25	0.14	0.018	0.054	2,250	EKZM250E□□102MJ25S
	1,500	12.5 × 20	0.14	0.017	0.043	2,480	EKZM250E□□152MK20S
	1,800	12.5 × 25	0.14	0.015	0.038	2,900	EKZM250E□□182MK25S
	2,200	12.5 × 30	0.16	0.013	0.033	3,450	EKZM250E□□222MK30S
	2,200	16 × 20	0.16	0.015	0.038	3,250	EKZM250E□□222ML20S
	2,700	12.5 × 35	0.16	0.012	0.031	3,570	EKZM250E□□272MK35S
3,300	16 × 25	0.18	0.013	0.035	3,630	EKZM250E□□332ML25S	
3,900	18 × 25	0.18	0.012	0.031	3,650	EKZM250E□□392MM25S	
35	47	5 × 11	0.12	0.22	0.80	345	EKZM350E□□470ME11D
	100	6.3 × 11	0.12	0.094	0.35	540	EKZM350E□□101MF11D
	220	8 × 11.5	0.12	0.056	0.19	945	EKZM350E□□221MHB5D
	270	8 × 15	0.12	0.045	0.15	1,250	EKZM350E□□271MH15D
	330	10 × 12.5	0.12	0.039	0.14	1,330	EKZM350E□□331MJC5S
	390	8 × 20	0.12	0.029	0.11	1,500	EKZM350E□□391MH20D
	470	10 × 16	0.12	0.028	0.10	1,760	EKZM350E□□471MJ16S
	560	10 × 20	0.12	0.020	0.060	1,960	EKZM350E□□561MJ20S
	680	10 × 25	0.12	0.018	0.054	2,250	EKZM350E□□681MJ25S
	1,000	12.5 × 20	0.12	0.017	0.043	2,480	EKZM350E□□102MK20S
	1,200	12.5 × 25	0.12	0.015	0.038	2,900	EKZM350E□□122MK25S
	1,500	12.5 × 30	0.12	0.013	0.033	3,450	EKZM350E□□152MK30S
	1,500	16 × 20	0.12	0.015	0.038	3,250	EKZM350E□□152ML20S
	1,800	12.5 × 35	0.12	0.012	0.031	3,570	EKZM350E□□182MK35S
2,200	16 × 25	0.14	0.013	0.035	3,630	EKZM350E□□222ML25S	
2,700	18 × 25	0.14	0.012	0.031	3,650	EKZM350E□□272MM25S	
50	27	5 × 11	0.10	0.34	1.18	238	EKZM500E□□270ME11D
	56	6.3 × 11	0.10	0.14	0.50	385	EKZM500E□□560MF11D
	100	8 × 11.5	0.10	0.074	0.22	724	EKZM500E□□101MHB5D
	120	8 × 15	0.10	0.061	0.18	950	EKZM500E□□121MH15D
	150	10 × 12.5	0.10	0.061	0.18	979	EKZM500E□□151MJC5S
	180	8 × 20	0.10	0.046	0.14	1,190	EKZM500E□□181MH20D
	220	10 × 16	0.10	0.042	0.12	1,370	EKZM500E□□221MJ16S
	270	10 × 20	0.10	0.030	0.090	1,580	EKZM500E□□271MJ20S
	330	10 × 25	0.10	0.028	0.085	1,870	EKZM500E□□331MJ25S
	470	12.5 × 20	0.10	0.027	0.068	2,050	EKZM500E□□471MK20S
	560	12.5 × 25	0.10	0.023	0.059	2,410	EKZM500E□□561MK25S
	680	12.5 × 30	0.10	0.021	0.052	2,860	EKZM500E□□681MK30S
	820	12.5 × 35	0.10	0.019	0.051	2,960	EKZM500E□□821MK35S
	820	16 × 20	0.10	0.023	0.059	2,730	EKZM500E□□821ML20S
1,000	16 × 25	0.10	0.021	0.056	3,010	EKZM500E□□102ML25S	
1,500	18 × 25	0.10	0.019	0.051	3,290	EKZM500E□□152MM25S	

□□ : Enter the appropriate lead forming or taping code.

KZH Series

- Newly innovative electrolyte is employed to minimize impedance
- Endurance with ripple current: 5,000 to 6,000 hours at 105°C
- Non solvent resistant type
- RoHS Compliant

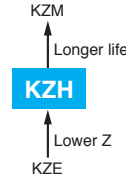

◆ SPECIFICATIONS

Items	Characteristics												
Category Temperature Range	-40 to +105°C												
Rated Voltage Range	6.3 to 35V _{dc}												
Capacitance Tolerance	±20% (M) (at 20°C, 120Hz)												
Leakage Current	I=0.01CV or 3µA, whichever is greater. Where, I : Max. leakage current (µA), C : Nominal capacitance (µF), V : Rated voltage (V) (at 20°C after 2 minutes)												
Dissipation Factor (tanδ)	<table border="1"> <tr> <td>Rated voltage (V_{dc})</td> <td>6.3V</td> <td>10V</td> <td>16V</td> <td>25V</td> <td>35V</td> </tr> <tr> <td>tanδ (Max.)</td> <td>0.22</td> <td>0.19</td> <td>0.16</td> <td>0.14</td> <td>0.12</td> </tr> </table> <p>When nominal capacitance exceeds 1,000µF, add 0.02 to the value above for each 1,000µF increase. (at 20°C, 120Hz)</p>	Rated voltage (V _{dc})	6.3V	10V	16V	25V	35V	tanδ (Max.)	0.22	0.19	0.16	0.14	0.12
Rated voltage (V _{dc})	6.3V	10V	16V	25V	35V								
tanδ (Max.)	0.22	0.19	0.16	0.14	0.12								
Low Temperature Characteristics (Max. Impedance Ratio)	<table border="1"> <tr> <td>Z (-25°C) / Z (+20°C)</td> <td>2max.</td> </tr> <tr> <td>Z (-40°C) / Z (+20°C)</td> <td>3max.</td> </tr> </table> <p>(at 120Hz)</p>	Z (-25°C) / Z (+20°C)	2max.	Z (-40°C) / Z (+20°C)	3max.								
Z (-25°C) / Z (+20°C)	2max.												
Z (-40°C) / Z (+20°C)	3max.												
Endurance	<p>The following specifications shall be satisfied when the capacitors are restored to 20°C after subjected to DC voltage with the rated ripple current is applied (the peak voltage shall not exceed the rated voltage) for the specified period of time at 105°C.</p> <table border="1"> <tr> <td>Time</td> <td>φ5 & φ6.3 : 5,000hours</td> <td>φ8 to φ16 : 6,000hours</td> </tr> <tr> <td>Capacitance change</td> <td colspan="2">≤ ±25% of the initial value (6.3, 10V_{dc} : ≤ ±30%)</td> </tr> <tr> <td>D.F. (tanδ)</td> <td colspan="2">≤200% of the initial specified value</td> </tr> <tr> <td>Leakage current</td> <td colspan="2">≤The initial specified value</td> </tr> </table>	Time	φ5 & φ6.3 : 5,000hours	φ8 to φ16 : 6,000hours	Capacitance change	≤ ±25% of the initial value (6.3, 10V _{dc} : ≤ ±30%)		D.F. (tanδ)	≤200% of the initial specified value		Leakage current	≤The initial specified value	
Time	φ5 & φ6.3 : 5,000hours	φ8 to φ16 : 6,000hours											
Capacitance change	≤ ±25% of the initial value (6.3, 10V _{dc} : ≤ ±30%)												
D.F. (tanδ)	≤200% of the initial specified value												
Leakage current	≤The initial specified value												
Shelf Life	<p>The following specifications shall be satisfied when the capacitors are restored to 20°C after exposing them for 500 hours at 105°C without voltage applied. Before the measurement, the capacitor shall be preconditioned by applying voltage according to Item 4.1 of JIS C 5101-4.</p> <table border="1"> <tr> <td>Capacitance change</td> <td>≤ ±25% of the initial value (6.3, 10V_{dc} : ≤ ±30%)</td> </tr> <tr> <td>D.F. (tanδ)</td> <td>≤200% of the initial specified value</td> </tr> <tr> <td>Leakage current</td> <td>≤The initial specified value</td> </tr> </table>	Capacitance change	≤ ±25% of the initial value (6.3, 10V _{dc} : ≤ ±30%)	D.F. (tanδ)	≤200% of the initial specified value	Leakage current	≤The initial specified value						
Capacitance change	≤ ±25% of the initial value (6.3, 10V _{dc} : ≤ ±30%)												
D.F. (tanδ)	≤200% of the initial specified value												
Leakage current	≤The initial specified value												

◆ DIMENSIONS [mm]

- Terminal Code : E

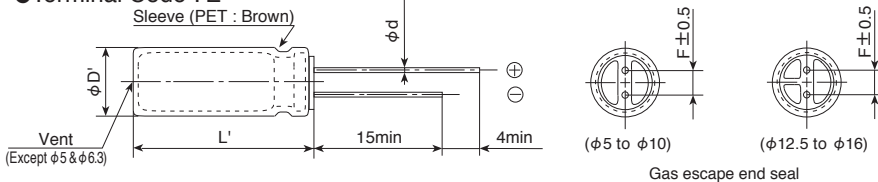

φD	5	6.3	8	10	12.5	16
φd	0.5	0.5	0.6	0.6	0.6	0.8
F	2.0	2.5	3.5	5.0	5.0	7.5
φD'	φD+0.5max.					
L'	L+1.5max.					

◆ PART NUMBERING SYSTEM

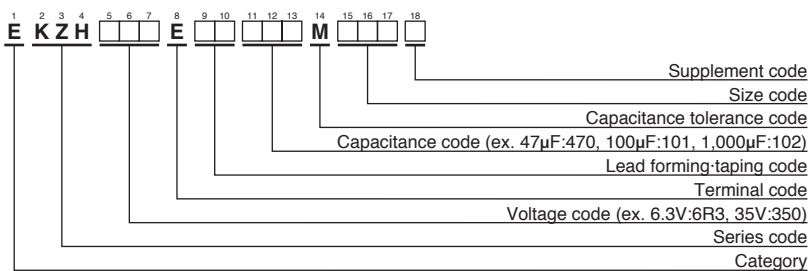

Please refer to "Product code guide (radial lead type)"

◆ STANDARD RATINGS

WV (Vdc)	Cap (μF)	Case size φD×L(mm)	Impedance (Ωmax/100kHz)		Rated ripple current (mA rms/105°C, 100kHz)	Part No.	WV (Vdc)	Cap (μF)	Case size φD×L(mm)	Impedance (Ωmax/100kHz)		Rated ripple current (mA rms/105°C, 100kHz)	Part No.	
			20°C	-10°C						20°C	-10°C			
6.3	220	5×11	0.24	0.80	330	EKZH6R3E□□221ME11D	16	1,800	10×25	0.018	0.054	2,250	EKZH160E□□182MJ25S	
	470	6.3×11	0.11	0.35	500	EKZH6R3E□□471MF11D		2,200	12.5×20	0.017	0.043	2,480	EKZH160E□□222MK20S	
	820	8×11.5	0.062	0.19	900	EKZH6R3E□□821MHB5D		2,700	12.5×25	0.015	0.038	2,900	EKZH160E□□272MK25S	
	1,200	8×15	0.048	0.15	1,210	EKZH6R3E□□122MH15D		3,300	12.5×30	0.013	0.033	3,450	EKZH160E□□332MK30S	
	1,200	10×12.5	0.045	0.14	1,240	EKZH6R3E□□122MJC5S		3,300	16×20	0.015	0.038	3,250	EKZH160E□□332ML20S	
	1,500	8×20	0.033	0.11	1,410	EKZH6R3E□□152MH20D		3,900	12.5×35	0.012	0.031	3,570	EKZH160E□□392MK35S	
	1,800	10×16	0.032	0.10	1,650	EKZH6R3E□□182MJ16S		4,700	16×25	0.013	0.035	3,630	EKZH160E□□472ML25S	
	2,200	10×20	0.020	0.060	1,960	EKZH6R3E□□222MJ20S		25	68	5×11	0.24	0.80	330	EKZH250E□□680ME11D
	2,700	10×25	0.018	0.054	2,250	EKZH6R3E□□272MJ25S			150	6.3×11	0.11	0.35	500	EKZH250E□□151MF11D
	3,900	12.5×20	0.017	0.043	2,480	EKZH6R3E□□392MK20S			330	8×11.5	0.062	0.19	900	EKZH250E□□331MHB5D
	4,700	12.5×25	0.015	0.038	2,900	EKZH6R3E□□472MK25S			390	8×15	0.048	0.15	1,210	EKZH250E□□391MH15D
	5,600	12.5×30	0.013	0.033	3,450	EKZH6R3E□□562MK30S			470	10×12.5	0.045	0.14	1,240	EKZH250E□□471MJC5S
	6,800	12.5×35	0.012	0.031	3,570	EKZH6R3E□□682MK35S			560	8×20	0.033	0.11	1,410	EKZH250E□□561MH20D
	6,800	16×20	0.015	0.038	3,250	EKZH6R3E□□682ML20S			680	10×16	0.032	0.10	1,650	EKZH250E□□681MJ16S
	8,200	16×25	0.013	0.035	3,630	EKZH6R3E□□822ML25S			820	10×20	0.020	0.060	1,960	EKZH250E□□821MJ20S
	10	150	5×11	0.24	0.80	330			EKZH100E□□151ME11D	1,000	10×25	0.018	0.054	2,250
330		6.3×11	0.11	0.35	500	EKZH100E□□331MF11D	1,500		12.5×20	0.017	0.043	2,480	EKZH250E□□152MK20S	
680		8×11.5	0.062	0.19	900	EKZH100E□□681MHB5D	1,800		12.5×25	0.015	0.038	2,900	EKZH250E□□182MK25S	
1,000		8×15	0.048	0.15	1,210	EKZH100E□□102MH15D	2,200		12.5×30	0.013	0.033	3,450	EKZH250E□□222MK30S	
1,000		10×12.5	0.045	0.14	1,240	EKZH100E□□102MJC5S	2,200		16×20	0.015	0.038	3,250	EKZH250E□□222ML20S	
1,500		8×20	0.033	0.11	1,410	EKZH100E□□152MH20D	2,700		12.5×35	0.012	0.031	3,570	EKZH250E□□272MK35S	
1,500		10×16	0.032	0.10	1,650	EKZH100E□□152MJ16S	3,300		16×25	0.013	0.035	3,630	EKZH250E□□332ML25S	
1,800		10×20	0.020	0.060	1,960	EKZH100E□□182MJ20S	35		47	5×11	0.24	0.80	330	EKZH350E□□470ME11D
2,200		10×25	0.018	0.054	2,250	EKZH100E□□222MJ25S		100	6.3×11	0.11	0.35	500	EKZH350E□□101MF11D	
3,300		12.5×20	0.017	0.043	2,480	EKZH100E□□332MK20S		220	8×11.5	0.062	0.19	900	EKZH350E□□221MHB5D	
3,900		12.5×25	0.015	0.038	2,900	EKZH100E□□392MK25S		270	8×15	0.048	0.15	1,210	EKZH350E□□271MH15D	
4,700		12.5×30	0.013	0.033	3,450	EKZH100E□□472MK30S		330	10×12.5	0.045	0.14	1,240	EKZH350E□□331MJC5S	
4,700		16×20	0.015	0.038	3,250	EKZH100E□□472ML20S		390	8×20	0.033	0.11	1,410	EKZH350E□□391MH20D	
5,600		12.5×35	0.012	0.031	3,570	EKZH100E□□562MK35S		470	10×16	0.032	0.10	1,650	EKZH350E□□471MJ16S	
6,800		16×25	0.013	0.035	3,630	EKZH100E□□682ML25S		560	10×20	0.020	0.060	1,960	EKZH350E□□561MJ20S	
16		100	5×11	0.24	0.80	330		EKZH160E□□101ME11D	680	10×25	0.018	0.054	2,250	EKZH350E□□681MJ25S
	220	6.3×11	0.11	0.35	500	EKZH160E□□221MF11D		1,000	12.5×20	0.017	0.043	2,480	EKZH350E□□102MK20S	
	470	8×11.5	0.062	0.19	900	EKZH160E□□471MHB5D		1,200	12.5×25	0.015	0.038	2,900	EKZH350E□□122MK25S	
	680	8×15	0.048	0.15	1,210	EKZH160E□□681MH15D		1,500	12.5×30	0.013	0.033	3,450	EKZH350E□□152MK30S	
	680	10×12.5	0.045	0.14	1,240	EKZH160E□□681MJC5S		1,500	16×20	0.015	0.038	3,250	EKZH350E□□152ML20S	
	1,000	8×20	0.033	0.11	1,410	EKZH160E□□102MH20D		1,800	12.5×35	0.012	0.031	3,570	EKZH350E□□182MK35S	
	1,000	10×16	0.032	0.10	1,650	EKZH160E□□102MJ16S		2,200	16×25	0.013	0.035	3,630	EKZH350E□□222ML25S	
	1,500	10×20	0.020	0.060	1,960	EKZH160E□□152MJ20S								

□□ : Enter the appropriate lead forming or taping code.

◆ RATED RIPPLE CURRENT MULTIPLIERS

● Frequency Multipliers

Capacitance (μF)	Frequency (Hz)			
	120	1k	10k	100k
0.47 to 150	0.40	0.75	0.90	1.00
220 to 560	0.50	0.85	0.94	1.00
680 to 1,800	0.60	0.87	0.95	1.00
2,200 to 3,900	0.75	0.90	0.95	1.00
4,700 to 8,200	0.85	0.95	0.98	1.00

The endurance of capacitors is reduced with internal heating produced by ripple current at the rate of halving the lifetime with every 5°C rise. When long life performance is required in actual use, the rms ripple current has to be reduced.

KZE Series

- Newly innovative electrolyte is employed to minimize impedance
- Endurance with ripple current: 1,000 to 5,000 hours at 105°C
- Non solvent resistant type
- RoHS Compliant



◆ SPECIFICATIONS

Items	Characteristics
Category	
Temperature Range	-40 to +105°C
Rated Voltage Range	6.3 to 100V _{dc}
Capacitance Tolerance	±20% (M) (at 20°C, 120Hz)
Leakage Current	I=0.01CV or 3μA, whichever is greater. Where, I : Max. leakage current (μA), C : Nominal capacitance (μF), V : Rated voltage (V) (at 20°C after 2 minutes)
Dissipation Factor (tanδ)	Rated voltage (V _{dc})
	tanδ (Max.)
Low Temperature Characteristics (Max. Impedance Ratio)	Z (-25°C) / Z (+20°C)
	Z (-40°C) / Z (+20°C)
Endurance	The following specifications shall be satisfied when the capacitors are restored to 20°C after subjected to DC voltage with the rated ripple current is applied (the peak voltage shall not exceed the rated voltage) for the specified period of time at 105°C.
	Time
	Capacitance change
	D.F. (tanδ)
	Leakage current
Shelf Life	The following specifications shall be satisfied when the capacitors are restored to 20°C after exposing them for 500 hours at 105°C without voltage applied. Before the measurement, the capacitor shall be preconditioned by applying voltage according to Item 4.1 of JIS C 5101-4.
	Capacitance change
	D.F. (tanδ)
	Leakage current

◆ DIMENSIONS [mm]

- Terminal Code : E

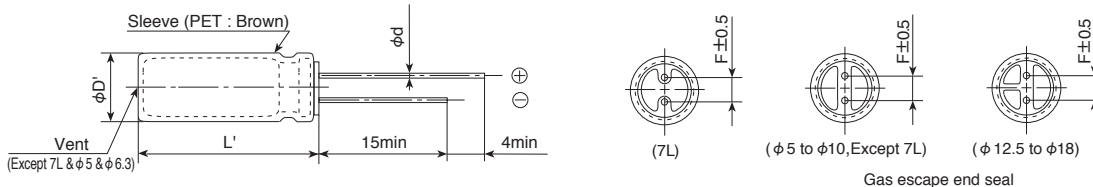

φD	5	6.3	8	10, 12.5	16, 18
φd	7L	0.45	0.45	0.45	—
	11L~	0.5	0.5	0.6	0.6
F		2.0	2.5	3.5	5.0
φD'	φD+0.5max.				
L'	L+1.5max.(7L : L+1.0max.)				

◆ PART NUMBERING SYSTEM

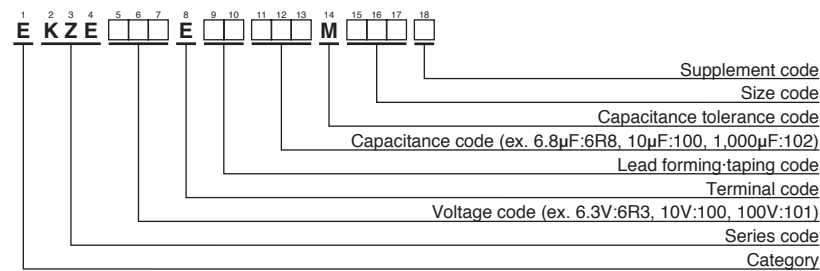

Please refer to "Product code guide (radial lead type)"

◆ STANDARD RATINGS

WV (Vdc)	Cap (μF)	Case size φD×L(mm)	Impedance (Ω max/100kHz)		Rated ripple current (mA rms/ 105°C, 100kHz)	Part No.	WV (Vdc)	Cap (μF)	Case size φD×L(mm)	Impedance (Ω max/100kHz)		Rated ripple current (mA rms/ 105°C, 100kHz)	Part No.	
			20°C	-10°C						20°C	-10°C			
6.3	68	5×7	0.43	1.3	210	EKZE6R3E□□680ME07D	25	820	10×25	0.022	0.066	2,150	EKZE250E□□821MJ25S	
	150	5×11	0.30	1.0	250	EKZE6R3E□□151ME11D		1,000	12.5×20	0.021	0.053	2,360	EKZE250E□□102MK20S	
	150	6.3×7	0.23	0.69	300	EKZE6R3E□□151MF07D		1,500	12.5×25	0.018	0.045	2,770	EKZE250E□□152MK25S	
	220	8×7	0.15	0.45	380	EKZE6R3E□□221MH07D		1,800	12.5×30	0.016	0.041	3,290	EKZE250E□□182MK30S	
	330	6.3×11	0.13	0.41	405	EKZE6R3E□□331MF11D		1,800	16×20	0.018	0.045	3,140	EKZE250E□□182ML20S	
	560	8×11.5	0.072	0.22	760	EKZE6R3E□□561MHB5D		2,200	12.5×35	0.015	0.039	3,400	EKZE250E□□222MK35S	
	820	8×15	0.056	0.17	995	EKZE6R3E□□821MH15D		2,700	16×25	0.016	0.043	3,460	EKZE250E□□272ML25S	
	1,000	10×12.5	0.053	0.16	1,030	EKZE6R3E□□102MJC5S		35	18	5×7	0.47	1.5	210	EKZE350E□□180ME07D
	1,200	8×20	0.041	0.13	1,250	EKZE6R3E□□122MH20D			33	5×11	0.30	1.0	250	EKZE350E□□330ME11D
	1,200	10×16	0.038	0.12	1,430	EKZE6R3E□□122MJ16S			39	6.3×7	0.25	0.75	300	EKZE350E□□390MF07D
	1,500	10×20	0.023	0.069	1,820	EKZE6R3E□□152MJ20S			56	6.3×11	0.13	0.41	405	EKZE350E□□560MF11D
	2,200	10×25	0.022	0.066	2,150	EKZE6R3E□□222MJ25S			56	8×7	0.16	0.48	380	EKZE350E□□560MH07D
	3,300	12.5×20	0.021	0.053	2,360	EKZE6R3E□□332MK20S			150	8×11.5	0.072	0.22	760	EKZE350E□□151MHB5D
	3,900	12.5×25	0.018	0.045	2,770	EKZE6R3E□□392MK25S			220	8×15	0.056	0.17	995	EKZE350E□□221MH15D
	4,700	12.5×30	0.016	0.041	3,290	EKZE6R3E□□472MK30S			220	10×12.5	0.053	0.16	1,030	EKZE350E□□221MJC5S
	5,600	12.5×35	0.015	0.039	3,400	EKZE6R3E□□562MK35S			270	8×20	0.041	0.13	1,250	EKZE350E□□271MH20D
	5,600	16×20	0.018	0.045	3,140	EKZE6R3E□□562ML20S			330	10×16	0.038	0.12	1,430	EKZE350E□□331MJ16S
	6,800	16×25	0.016	0.043	3,460	EKZE6R3E□□682ML25S			470	10×20	0.023	0.069	1,820	EKZE350E□□471MJ20S
10	56	5×7	0.44	1.4	210	EKZE100E□□560ME07D	560		10×25	0.022	0.066	2,150	EKZE350E□□561MJ25S	
	100	5×11	0.30	1.0	250	EKZE100E□□101ME11D	680		12.5×20	0.021	0.053	2,360	EKZE350E□□681MK20S	
	120	6.3×7	0.23	0.69	300	EKZE100E□□121MF07D	1,000		12.5×25	0.018	0.045	2,770	EKZE350E□□102MK25S	
	180	8×7	0.15	0.45	380	EKZE100E□□181MH07D	1,200		12.5×30	0.016	0.041	3,290	EKZE350E□□122MK30S	
	220	6.3×11	0.13	0.41	405	EKZE100E□□221MF11D	1,200		16×20	0.018	0.045	3,140	EKZE350E□□122ML20S	
	470	8×11.5	0.072	0.22	760	EKZE100E□□471MHB5D	1,500		12.5×35	0.015	0.039	3,400	EKZE350E□□152MK35S	
	680	8×15	0.056	0.17	995	EKZE100E□□681MH15D	1,800		16×25	0.016	0.043	3,460	EKZE350E□□182ML25S	
	680	10×12.5	0.053	0.16	1,030	EKZE100E□□681MJC5S	50	10	5×7	0.50	1.5	210	EKZE500E□□100ME07D	
	1,000	8×20	0.041	0.13	1,250	EKZE100E□□102MH20D		22	5×11	0.34	1.18	238	EKZE500E□□220ME11D	
	1,000	10×16	0.038	0.12	1,430	EKZE100E□□102MJ16S		22	6.3×7	0.26	0.78	300	EKZE500E□□220MF07D	
	1,200	10×20	0.023	0.069	1,820	EKZE100E□□122MJ20S		33	8×7	0.17	0.51	380	EKZE500E□□330MH07D	
	1,500	10×25	0.022	0.066	2,150	EKZE100E□□152MJ25S		56	6.3×11	0.14	0.50	385	EKZE500E□□560MF11D	
	2,200	12.5×20	0.021	0.053	2,360	EKZE100E□□222MK20S		100	8×11.5	0.074	0.22	724	EKZE500E□□101MHB5D	
	3,300	12.5×25	0.018	0.045	2,770	EKZE100E□□332MK25S		120	8×15	0.061	0.18	950	EKZE500E□□121MH15D	
	3,900	12.5×30	0.016	0.041	3,290	EKZE100E□□392MK30S		150	10×12.5	0.061	0.18	979	EKZE500E□□151MJC5S	
	3,900	16×20	0.018	0.045	3,140	EKZE100E□□392ML20S		180	8×20	0.046	0.14	1,190	EKZE500E□□181MH20D	
	4,700	12.5×35	0.015	0.039	3,400	EKZE100E□□472MK35S		220	10×16	0.042	0.12	1,370	EKZE500E□□221MJ16S	
	5,600	16×25	0.016	0.043	3,460	EKZE100E□□562ML25S		270	10×20	0.030	0.090	1,580	EKZE500E□□271MJ20S	
16	33	5×7	0.45	1.4	210	EKZE160E□□330ME07D		330	10×25	0.028	0.085	1,870	EKZE500E□□331MJ25S	
	56	5×11	0.30	1.0	250	EKZE160E□□560ME11D		470	12.5×20	0.027	0.068	2,050	EKZE500E□□471MK20S	
	68	6.3×7	0.24	0.72	300	EKZE160E□□680MF07D		560	12.5×25	0.023	0.059	2,410	EKZE500E□□561MK25S	
	120	6.3×11	0.13	0.41	405	EKZE160E□□121MF11D		680	12.5×30	0.021	0.052	2,860	EKZE500E□□681MK30S	
	120	8×7	0.15	0.45	380	EKZE160E□□121MH07D		820	12.5×35	0.019	0.051	2,960	EKZE500E□□821MK35S	
	330	8×11.5	0.072	0.22	760	EKZE160E□□331MHB5D		820	16×20	0.023	0.059	2,730	EKZE500E□□821ML20S	
	470	8×15	0.056	0.17	995	EKZE160E□□471MH15D		1,000	16×25	0.021	0.056	3,010	EKZE500E□□102ML25S	
	470	10×12.5	0.053	0.16	1,030	EKZE160E□□471MJC5S	63	15	5×11	0.88	3.5	165	EKZE630E□□150ME11D	
	680	8×20	0.041	0.13	1,250	EKZE160E□□681MH20D		33	6.3×11	0.35	1.4	265	EKZE630E□□330MF11D	
	680	10×16	0.038	0.12	1,430	EKZE160E□□681MJ16S		56	8×11.5	0.22	0.88	500	EKZE630E□□560MHB5D	
	1,000	10×20	0.023	0.069	1,820	EKZE160E□□102MJ20S		82	8×15	0.16	0.64	665	EKZE630E□□820MH15D	
	1,200	10×25	0.022	0.066	2,150	EKZE160E□□122MJ25S		82	10×12.5	0.11	0.44	690	EKZE630E□□820MJC5S	
	1,500	12.5×20	0.021	0.053	2,360	EKZE160E□□152MK20S		120	8×20	0.12	0.48	820	EKZE630E□□121MH20D	
	2,200	12.5×25	0.018	0.045	2,770	EKZE160E□□222MK25S		120	10×16	0.076	0.31	950	EKZE630E□□121MJ16S	
	2,700	12.5×30	0.016	0.041	3,290	EKZE160E□□272MK30S		180	10×20	0.056	0.23	1,150	EKZE630E□□181MJ20S	
	2,700	16×20	0.018	0.045	3,140	EKZE160E□□272ML20S		180	12.5×16	0.072	0.29	1,150	EKZE630E□□181MK16S	
	3,300	12.5×35	0.015	0.039	3,400	EKZE160E□□332MK35S		220	10×25	0.046	0.19	1,350	EKZE630E□□221MJ25S	
	3,900	16×25	0.016	0.043	3,460	EKZE160E□□392ML25S		270	12.5×20	0.041	0.13	1,500	EKZE630E□□271MK20S	
25	27	5×7	0.46	1.4	210	EKZE250E□□270ME07D		390	12.5×25	0.031	0.093	1,900	EKZE630E□□391MK25S	
	47	5×11	0.30	1.0	250	EKZE250E□□470ME11D		470	12.5×30	0.028	0.084	2,300	EKZE630E□□471MK30S	
	56	6.3×7	0.24	0.72	300	EKZE250E□□560MF07D		470	16×20	0.032	0.096	2,000	EKZE630E□□471ML20S	
	100	6.3×11	0.13	0.41	405	EKZE250E□□101MF11D		560	12.5×35	0.024	0.072	2,500	EKZE630E□□561MK35S	
	100	8×7	0.15	0.45	380	EKZE250E□□101MH07D		680	12.5×40	0.021	0.063	2,800	EKZE630E□□681MK40S	
	220	8×11.5	0.072	0.22	760	EKZE250E□□221MHB5D		680	16×25	0.025	0.075	2,600	EKZE630E□□681ML25S	
	330	8×15	0.056	0.17	995	EKZE250E□□331MH15D		680	18×20	0.030	0.090	2,500	EKZE630E□□681MM20S	
	330	10×12.5	0.053	0.16	1,030	EKZE250E□□331MJC5S	820	16×31.5	0.021	0.063	2,850	EKZE630E□□821MLN3S		
	470	8×20	0.041	0.13	1,250	EKZE250E□□471MH20D	820	18×25	0.024	0.072	2,800	EKZE630E□□821MM25S		
	470	10×16	0.038	0.12	1,430	EKZE250E□□471MJ16S	1,000	16×35.5	0.019	0.057	2,900	EKZE630E□□102MLP1S		
	680	10×20	0.023	0.069	1,820	EKZE250E□□681MJ20S	1,200	16×40	0.018	0.054	3,400	EKZE630E□□122ML40S		

□ : Enter the appropriate lead forming or taping code.

◆STANDARD RATINGS

WV (Vdc)	Cap (μF)	Case size φD×L(mm)	Impedance (Ωmax/100kHz)		Rated ripple current (mA rms/105°C, 100kHz)	Part No.	WV (Vdc)	Cap (μF)	Case size φD×L(mm)	Impedance (Ωmax/100kHz)		Rated ripple current (mA rms/105°C, 100kHz)	Part No.
			20°C	-10°C						20°C	-10°C		
63	1,200	18×31.5	0.020	0.060	3,300	EKZE630E□□122MMN3S	100	6.8	5×11	1.4	5.6	125	EKZE101E□□6R8ME11D
	1,500	18×35.5	0.018	0.054	3,400	EKZE630E□□152MMP1S		15	6.3×11	0.57	2.3	205	EKZE101E□□150MF11D
	1,800	18×40	0.017	0.051	3,500	EKZE630E□□182MM40S		27	8×11.5	0.36	1.4	355	EKZE101E□□270MHB5D
80	68	10×12.5	0.17	0.66	480	EKZE800E□□680MJC5S		39	8×15	0.25	1.0	450	EKZE101E□□390MH15D
	100	10×16	0.11	0.47	600	EKZE800E□□101MJ16S		47	10×12.5	0.17	0.66	480	EKZE101E□□470MJC5S
	120	10×20	0.084	0.34	800	EKZE800E□□121MJ20S		56	8×20	0.19	0.76	565	EKZE101E□□560MH20D
	150	10×25	0.069	0.28	900	EKZE800E□□151MJ25S		68	10×16	0.11	0.47	600	EKZE101E□□680MJ16S
	150	12.5×16	0.11	0.34	750	EKZE800E□□151MK16S		82	10×20	0.084	0.34	800	EKZE101E□□820MJ20S
	220	12.5×20	0.062	0.18	1,100	EKZE800E□□221MK20S		100	12.5×16	0.11	0.34	750	EKZE101E□□101MK16S
	330	12.5×25	0.047	0.14	1,250	EKZE800E□□331MK25S		120	10×25	0.069	0.28	900	EKZE101E□□121MJ25S
	330	16×20	0.048	0.15	1,350	EKZE800E□□331ML20S		150	12.5×20	0.062	0.18	1,100	EKZE101E□□151MK20S
	390	12.5×30	0.042	0.13	1,500	EKZE800E□□391MK30S		220	12.5×25	0.047	0.14	1,250	EKZE101E□□221MK25S
	470	12.5×35	0.036	0.11	1,650	EKZE800E□□471MK35S		270	16×20	0.048	0.15	1,350	EKZE101E□□271MK20S
	470	16×25	0.038	0.12	1,700	EKZE800E□□471ML25S		270	12.5×30	0.042	0.13	1,500	EKZE101E□□271MK30S
	470	18×20	0.045	0.14	1,500	EKZE800E□□471MM20S		330	12.5×35	0.036	0.11	1,650	EKZE101E□□331MK35S
	560	12.5×40	0.032	0.095	1,800	EKZE800E□□561MK40S		330	16×25	0.038	0.12	1,700	EKZE101E□□331ML25S
	680	16×31.5	0.032	0.095	1,850	EKZE800E□□681MLN3S		330	18×20	0.045	0.14	1,500	EKZE101E□□331MM20S
	680	18×25	0.036	0.11	1,750	EKZE800E□□681MM25S		390	12.5×40	0.032	0.095	1,800	EKZE101E□□391MK40S
	820	16×35.5	0.029	0.086	2,000	EKZE800E□□821MLP1S		470	16×31.5	0.032	0.095	1,850	EKZE101E□□471MLN3S
	820	18×31.5	0.030	0.090	1,900	EKZE800E□□821MMN3S		470	18×25	0.036	0.11	1,750	EKZE101E□□471MM25S
	1,000	16×40	0.027	0.081	2,200	EKZE800E□□102ML40S		560	16×35.5	0.029	0.086	2,000	EKZE101E□□561MLP1S
	1,000	18×35.5	0.027	0.081	2,200	EKZE800E□□102MMP1S		560	18×31.5	0.030	0.090	1,900	EKZE101E□□561MMN3S
	1,200	18×40	0.026	0.077	2,700	EKZE800E□□122MM40S		680	16×40	0.027	0.081	2,200	EKZE101E□□681ML40S
						680		18×35.5	0.027	0.081	2,200	EKZE101E□□681MMP1S	
						820		18×40	0.026	0.077	2,700	EKZE101E□□821MM40S	

□ : Enter the appropriate lead forming or taping code.

◆RATED RIPPLE CURRENT MULTIPLIERS

●Frequency Multipliers

7L

Capacitance(μF)	Frequency (Hz)			
	120	1k	10k	100k
10 to 33	0.42	0.70	0.90	1.00
39 to 220	0.50	0.73	0.92	1.00

11L to 40L

Capacitance(μF)	Frequency (Hz)			
	120	1k	10k	100k
6.8 to 180	0.40	0.75	0.90	1.00
220 to 560	0.50	0.85	0.94	1.00
680 to 1,800	0.60	0.87	0.95	1.00
2,200 to 3,900	0.75	0.90	0.95	1.00
4,700 to	0.85	0.95	0.98	1.00

The endurance of capacitors is reduced with internal heating produced by ripple current at the rate of halving the lifetime with every 5°C rise. When long life performance is required in actual use, the rms ripple current has to be reduced.

New!

KYB Series

- Low impedance, high ripple and long life from KYA series
- Newly innovative electrolyte is employed to minimize impedance
- Endurance with ripple current : 4,000 to 10,000 hours at 105°C
- Non solvent resistant type
- RoHS Compliant

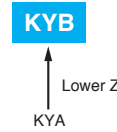

SPECIFICATIONS

Items	Characteristics										
Category	-40 to +105°C										
Temperature Range	-40 to +105°C										
Rated Voltage Range	6.3 to 100V _{dc}										
Capacitance Tolerance	±20% (M) (at 20°C, 120Hz)										
Leakage Current	I=0.01CV or 3μA, whichever is greater. Where, I : Max. leakage current (μA), C : Nominal capacitance (μF), V : Rated voltage (V) (at 20°C after 2 minutes)										
Dissipation Factor (tan δ)	Rated voltage (V _{dc})	6.3V	10V	16V	25V	35V	50V	63V	80V	100V	
	tan δ (Max)	0.22	0.19	0.16	0.14	0.12	0.10	0.09	0.09	0.08	
	When nominal capacitance exceeds 1,000μF, add 0.02 to the value above for each 1,000μF increase. (at 20°C, 120Hz)										
Low Temperature Characteristics (Max. Impedance Ratio)	Rated voltage (V _{dc})	6.3V	10V	16V	25V	35V	50V	63V	80V	100V	
	Z(-25°C)/Z(+20°C)	4	3	2	2	2	2	2	2	2	
	Z(-40°C)/Z(+20°C)	8	6	4	3	3	3	3	3	3	
Endurance	The following specifications shall be satisfied when the capacitors are restored to 20°C after subjected to DC voltage with the rated ripple current is applied (the peak voltage shall not exceed the rated voltage) for the specified period of time at 105°C.										
	Rated Voltage (V _{dc})	6.3 to 10V _{dc}					16 to 100V _{dc}				
	Time	φ5: 4,000hours φ6.3 & 8: 6,000hours φ10 to 18: 8,000hours			φ5: 5,000hours φ6.3 & 8: 7,000hours φ10 to 18: 10,000hours						
	Capacitance change	≤±30% of the initial value					≤±25% of the initial value				
	D.F. (tan δ)	≤200% of the initial specified value					≤200% of the initial specified value				
	Leakage current	≤The initial specified value					≤The initial specified value				
	Shelf Life	The following specifications shall be satisfied when the capacitors are restored to 20°C after exposing them for 500 hours at 105°C without voltage applied. Before the measurement, the capacitor shall be preconditioned by applying voltage according to Item 4.1 of JIS C 5101-4.									
Capacitance change		≤±25% of the initial value									
D.F. (tan δ)		≤200% of the initial specified value									
Leakage current		≤The initial specified value									

DIMENSIONS [mm]

- Terminal Code : E

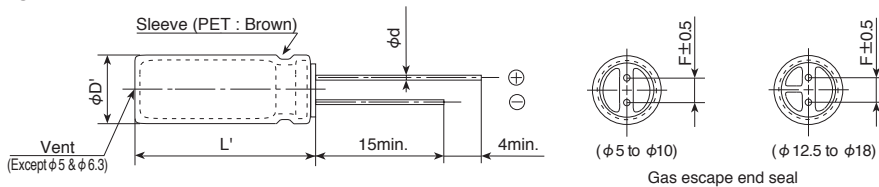

φD	5	6.3	8	10	12.5	16	18
φd	0.5	0.5	0.6	0.6	0.6	0.8	0.8
F	2.0	2.5	3.5	5.0	5.0	7.5	7.5
φD'	φD+0.5max.						
L'	L+1.5max.						

PART NUMBERING SYSTEM

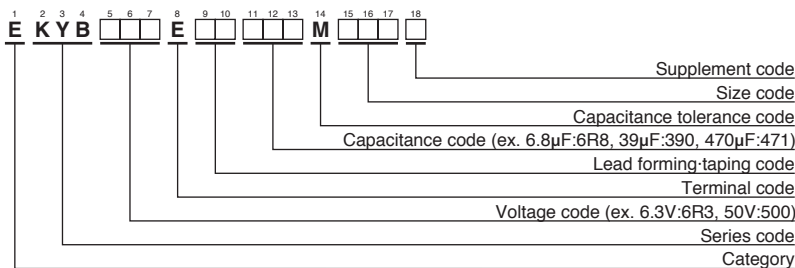

Please refer to "Product code guide (radial lead type)"

◆ STANDARD RATINGS

WV (Vdc)	Cap (μF)	Case size φD×L(mm)	Impedance (Ωmax/100kHz)		Rated ripple current (mA rms/105°C, 100kHz)	Part No.	WV (Vdc)	Cap (μF)	Case size φD×L(mm)	Impedance (Ωmax/100kHz)		Rated ripple current (mA rms/105°C, 100kHz)	Part No.	
			20°C	-10°C						20°C	-10°C			
6.3	180	5×11	0.29	1.2	340	EKYB6R3E□□181ME11D	16	4,700	12.5×35	0.018	0.072	3,140	EKYB160E□□472MK35S	
	390	6.3×11	0.15	0.60	540	EKYB6R3E□□391MF11D		4,700	18×20	0.021	0.084	3,000	EKYB160E□□472MM20S	
	820	8×11.5	0.087	0.35	840	EKYB6R3E□□821MHB5D		5,600	12.5×40	0.017	0.068	3,640	EKYB160E□□562MK40S	
	1,200	8×15	0.069	0.28	1,050	EKYB6R3E□□122MH15D		5,600	16×25	0.020	0.080	3,140	EKYB160E□□562ML25S	
	1,200	10×12.5	0.064	0.26	1,050	EKYB6R3E□□122MJC5S		6,800	16×31.5	0.016	0.064	3,610	EKYB160E□□682MLN3S	
	1,500	8×20	0.060	0.24	1,210	EKYB6R3E□□152MH20D		6,800	18×25	0.017	0.068	3,530	EKYB160E□□682MLM25S	
	1,800	10×16	0.049	0.20	1,400	EKYB6R3E□□182MJ16S		8,200	16×35.5	0.014	0.056	4,080	EKYB160E□□822MLP1S	
	2,200	10×20	0.037	0.15	1,650	EKYB6R3E□□222MJ20S		8,200	18×31.5	0.014	0.056	4,220	EKYB160E□□822MMN3S	
	2,700	10×25	0.031	0.13	1,910	EKYB6R3E□□272MJ25S		10,000	16×40	0.013	0.052	4,220	EKYB160E□□103ML40S	
	3,300	10×30	0.027	0.11	2,230	EKYB6R3E□□332MJ30S		10,000	18×35.5	0.012	0.048	4,280	EKYB160E□□103MMP1S	
	3,900	12.5×20	0.027	0.11	2,230	EKYB6R3E□□392MK20S		12,000	18×40	0.011	0.044	4,700	EKYB160E□□123MM40S	
	4,700	12.5×25	0.024	0.096	2,530	EKYB6R3E□□472MK25S		25	82	5×11	0.29	1.2	340	EKYB250E□□820ME11D
	6,800	12.5×30	0.021	0.084	2,860	EKYB6R3E□□682MK30S			150	6.3×11	0.15	0.60	540	EKYB250E□□151MF11D
	6,800	16×20	0.025	0.10	2,610	EKYB6R3E□□682ML20S			330	8×11.5	0.087	0.35	840	EKYB250E□□821MHB5D
	8,200	12.5×35	0.018	0.072	3,140	EKYB6R3E□□822MK35S			390	8×15	0.069	0.28	1,050	EKYB250E□□391MH15D
	8,200	18×20	0.021	0.084	3,000	EKYB6R3E□□822MM20S			470	10×12.5	0.064	0.26	1,050	EKYB250E□□471MJC5S
	10,000	12.5×40	0.017	0.068	3,640	EKYB6R3E□□103MK40S			560	8×20	0.060	0.24	1,210	EKYB250E□□561MH20D
	10,000	16×25	0.020	0.080	3,140	EKYB6R3E□□103ML25S			680	10×16	0.049	0.20	1,400	EKYB250E□□681MJ16S
	12,000	16×31.5	0.016	0.064	3,610	EKYB6R3E□□123MLN3S			1,000	10×20	0.037	0.15	1,650	EKYB250E□□102MJ20S
	12,000	18×25	0.017	0.068	3,530	EKYB6R3E□□123MM25S			1,200	10×25	0.031	0.13	1,910	EKYB250E□□122MJ25S
	15,000	16×35.5	0.014	0.056	4,080	EKYB6R3E□□153MLP1S			1,500	10×30	0.027	0.11	2,230	EKYB250E□□152MJ30S
	15,000	18×31.5	0.014	0.056	4,220	EKYB6R3E□□153MMN3S			1,500	12.5×20	0.027	0.11	2,230	EKYB250E□□152MK20S
18,000	16×40	0.013	0.052	4,220	EKYB6R3E□□183ML40S	2,200	12.5×25		0.024	0.096	2,530	EKYB250E□□222MK25S		
18,000	18×35.5	0.012	0.048	4,280	EKYB6R3E□□183MMP1S	2,700	12.5×30		0.021	0.084	2,860	EKYB250E□□272MK30S		
22,000	18×40	0.011	0.044	4,700	EKYB6R3E□□223MM40S	2,700	16×20		0.025	0.10	2,610	EKYB250E□□272ML20S		
10	120	5×11	0.29	1.2	340	EKYB100E□□121ME11D	3,300		12.5×35	0.018	0.072	3,140	EKYB250E□□332MK35S	
	330	6.3×11	0.15	0.60	540	EKYB100E□□331MF11D	3,300		18×20	0.021	0.084	3,000	EKYB250E□□332MM20S	
	560	8×11.5	0.087	0.35	840	EKYB100E□□561MHB5D	3,900		12.5×40	0.017	0.068	3,640	EKYB250E□□392MK40S	
	820	8×15	0.069	0.28	1,050	EKYB100E□□821MH15D	3,900		16×25	0.020	0.080	3,140	EKYB250E□□392ML25S	
	1,000	8×20	0.060	0.24	1,210	EKYB100E□□102MH20D	4,700		16×31.5	0.016	0.064	3,610	EKYB250E□□472MLN3S	
	1,000	10×12.5	0.064	0.26	1,050	EKYB100E□□102MJC5S	4,700		18×25	0.017	0.068	3,530	EKYB250E□□472MM25S	
	1,200	10×16	0.049	0.20	1,400	EKYB100E□□122MJ16S	5,600		16×35.5	0.014	0.056	4,080	EKYB250E□□562MLP1S	
	1,800	10×20	0.037	0.15	1,650	EKYB100E□□182MJ20S	6,800		16×40	0.013	0.052	4,220	EKYB250E□□682ML40S	
	2,200	10×25	0.031	0.13	1,910	EKYB100E□□222MJ25S	6,800	18×31.5	0.014	0.056	4,220	EKYB250E□□682MMN3S		
	2,700	10×30	0.027	0.11	2,230	EKYB100E□□272MJ30S	8,200	18×35.5	0.012	0.048	4,280	EKYB250E□□822MMP1S		
	2,700	12.5×20	0.027	0.11	2,230	EKYB100E□□272MK20S	35	47	5×11	0.29	1.2	340	EKYB350E□□470ME11D	
	3,900	12.5×25	0.024	0.096	2,530	EKYB100E□□392MK25S		100	6.3×11	0.15	0.60	540	EKYB350E□□101MF11D	
	4,700	12.5×30	0.021	0.084	2,860	EKYB100E□□472MK30S		180	8×11.5	0.087	0.35	840	EKYB350E□□181MHB5D	
	4,700	16×20	0.025	0.10	2,610	EKYB100E□□472ML20S		270	8×15	0.069	0.28	1,050	EKYB350E□□271MH15D	
	5,600	12.5×35	0.018	0.072	3,140	EKYB100E□□562MK35S		330	8×20	0.060	0.24	1,210	EKYB350E□□331MH20D	
	6,800	12.5×40	0.017	0.068	3,640	EKYB100E□□682MK40S		330	10×12.5	0.064	0.26	1,050	EKYB350E□□331MJC5S	
	6,800	16×25	0.020	0.080	3,140	EKYB100E□□682ML25S		470	10×16	0.049	0.20	1,400	EKYB350E□□471MJ16S	
	6,800	18×20	0.021	0.084	3,000	EKYB100E□□682MM20S		680	10×20	0.037	0.15	1,650	EKYB350E□□681MJ20S	
	8,200	16×31.5	0.016	0.064	3,610	EKYB100E□□822MLN3S		820	10×25	0.031	0.13	1,910	EKYB350E□□821MJ25S	
	8,200	18×25	0.017	0.068	3,530	EKYB100E□□822MM25S		1,000	10×30	0.027	0.11	2,230	EKYB350E□□102MJ30S	
	10,000	16×35.5	0.014	0.056	4,080	EKYB100E□□103MLP1S		1,000	12.5×20	0.027	0.11	2,230	EKYB350E□□102MK20S	
	10,000	18×31.5	0.014	0.056	4,220	EKYB100E□□103MMN3S		1,500	12.5×25	0.024	0.096	2,530	EKYB350E□□152MK25S	
12,000	16×40	0.013	0.052	4,220	EKYB100E□□123ML40S	1,800		12.5×30	0.021	0.084	2,860	EKYB350E□□182MK30S		
12,000	18×35.5	0.012	0.048	4,280	EKYB100E□□123MMP1S	1,800		16×20	0.025	0.10	2,610	EKYB350E□□182ML20S		
15,000	18×40	0.011	0.044	4,700	EKYB100E□□153MM40S	2,200		12.5×35	0.018	0.072	3,140	EKYB350E□□222MK35S		
16	120	5×11	0.29	1.2	340	EKYB160E□□121ME11D		2,200	18×20	0.021	0.084	3,000	EKYB350E□□222MM20S	
	270	6.3×11	0.15	0.60	540	EKYB160E□□271MF11D		2,700	12.5×40	0.017	0.068	3,640	EKYB350E□□272MK40S	
	470	8×11.5	0.087	0.35	840	EKYB160E□□471MHB5D		2,700	16×25	0.020	0.080	3,140	EKYB350E□□272ML25S	
	680	8×15	0.069	0.28	1,050	EKYB160E□□681MH15D		3,300	16×31.5	0.016	0.064	3,610	EKYB350E□□332MLN3S	
	680	10×12.5	0.064	0.26	1,050	EKYB160E□□681MJC5S		3,300	18×25	0.017	0.068	3,530	EKYB350E□□332MM25S	
	820	8×20	0.060	0.24	1,210	EKYB160E□□821MH20D		3,900	16×35.5	0.014	0.056	4,080	EKYB350E□□392MLP1S	
	1,000	10×16	0.049	0.20	1,400	EKYB160E□□102MJ16S		4,700	16×40	0.013	0.052	4,220	EKYB350E□□472ML40S	
	1,500	10×20	0.037	0.15	1,650	EKYB160E□□152MJ20S	4,700	18×31.5	0.014	0.056	4,220	EKYB350E□□472MMN3S		
	1,800	10×25	0.031	0.13	1,910	EKYB160E□□182MJ25S	5,600	18×35.5	0.012	0.048	4,280	EKYB350E□□562MMP1S		
	2,200	10×30	0.027	0.11	2,230	EKYB160E□□222MJ30S	50	27	5×11	0.48	2.0	238	EKYB500E□□270ME11D	
	2,200	12.5×20	0.027	0.11	2,230	EKYB160E□□222MK20S		56	6.3×11	0.20	0.80	385	EKYB500E□□560MF11D	
	3,300	12.5×25	0.024	0.096	2,530	EKYB160E□□332MK25S		100	8×11.5	0.12	0.48	620	EKYB500E□□101MHB5D	
	3,900	12.5×30	0.021	0.084	2,860	EKYB160E□□392MK30S		150	8×15	0.093	0.38	810	EKYB500E□□151MH15D	
	3,900	16×20	0.025	0.10	2,610	EKYB160E□□392ML20S		150	10×12.5	0.10	0.40	810	EKYB500E□□151MJC5S	

□ □ : Enter the appropriate lead forming or taping code.

◆STANDARD RATINGS

WV (Vdc)	Cap (μF)	Case size φD×L(mm)	Impedance (Ωmax/100kHz)		Rated ripple current (mA rms/105°C, 100kHz)	Part No.
			20°C	-10°C		
50	180	8×20	0.075	0.30	980	EKYB500E□□181MH20D
	220	10×16	0.069	0.28	1,100	EKYB500E□□221MJ16S
	270	10×20	0.055	0.22	1,300	EKYB500E□□271MJ20S
	390	10×25	0.043	0.18	1,600	EKYB500E□□391MJ25S
	470	10×30	0.038	0.16	1,820	EKYB500E□□471MJ30S
	470	12.5×20	0.034	0.14	1,820	EKYB500E□□471MK20S
	680	12.5×25	0.030	0.12	2,100	EKYB500E□□681MK25S
	820	12.5×30	0.025	0.10	2,450	EKYB500E□□821MK30S
	820	16×20	0.028	0.12	2,350	EKYB500E□□821ML20S
	1,000	12.5×35	0.021	0.084	2,800	EKYB500E□□102MK35S
	1,000	18×20	0.025	0.10	2,600	EKYB500E□□102MM20S
	1,200	12.5×40	0.019	0.076	3,100	EKYB500E□□122MK40S
	1,200	16×25	0.024	0.096	2,750	EKYB500E□□122ML25S
	1,500	16×31.5	0.019	0.076	3,150	EKYB500E□□152MLN3S
	1,500	18×25	0.021	0.084	2,890	EKYB500E□□152MM25S
	1,800	16×35.5	0.016	0.064	3,550	EKYB500E□□182MLP1S
	2,200	16×40	0.014	0.056	3,900	EKYB500E□□222ML40S
	2,200	18×31.5	0.014	0.056	3,800	EKYB500E□□222MMN3S
2,700	18×35.5	0.013	0.052	4,100	EKYB500E□□272MMP1S	
63	18	5×11	0.50	2.0	220	EKYB630E□□180ME11D
	33	6.3×11	0.25	1.0	350	EKYB630E□□330MF11D
	56	8×11.5	0.16	0.64	530	EKYB630E□□560MHB5D
	82	8×15	0.12	0.48	700	EKYB630E□□820MH15D
	120	8×20	0.085	0.34	880	EKYB630E□□121MH20D
	120	10×12.5	0.11	0.44	725	EKYB630E□□121MJC5S
	180	10×16	0.073	0.30	1,050	EKYB630E□□181MJ16S
	220	10×20	0.055	0.22	1,300	EKYB630E□□221MJ20S
	330	10×25	0.045	0.18	1,550	EKYB630E□□331MJ25S
	390	10×30	0.040	0.16	1,780	EKYB630E□□391MJ30S
	390	12.5×20	0.036	0.15	1,780	EKYB630E□□391MK20S
	560	12.5×25	0.030	0.12	2,100	EKYB630E□□561MK25S
	680	12.5×30	0.026	0.11	2,415	EKYB630E□□681MK30S
	680	16×20	0.028	0.12	2,250	EKYB630E□□681ML20S
	820	12.5×35	0.022	0.088	2,700	EKYB630E□□821MK35S
	820	18×20	0.028	0.12	2,500	EKYB630E□□821MM20S
	1,000	12.5×40	0.020	0.080	3,000	EKYB630E□□102MK40S
	1,000	16×25	0.025	0.10	2,730	EKYB630E□□102ML25S
1,200	16×31.5	0.020	0.080	3,000	EKYB630E□□122MLN3S	
1,200	18×25	0.022	0.088	2,800	EKYB630E□□122MM25S	
1,500	16×35.5	0.018	0.072	3,200	EKYB630E□□152MLP1S	
1,500	18×31.5	0.018	0.072	3,300	EKYB630E□□152MMN3S	
1,800	16×40	0.016	0.064	3,590	EKYB630E□□182ML40S	
1,800	18×35.5	0.017	0.068	3,570	EKYB630E□□182MMP1S	
2,200	18×40	0.016	0.064	3,670	EKYB630E□□222MM40S	
80	12	5×11	0.80	3.2	163	EKYB800E□□120ME11D
	22	6.3×11	0.43	1.8	267	EKYB800E□□220MF11D
	39	8×11.5	0.18	0.72	462	EKYB800E□□390MHB5D
80	56	8×15	0.14	0.56	585	EKYB800E□□560MH15D
	82	8×20	0.11	0.44	735	EKYB800E□□820MH20D
	82	10×12.5	0.14	0.56	624	EKYB800E□□820MJC5S
	120	10×16	0.10	0.40	780	EKYB800E□□121MJ16S
	180	10×20	0.075	0.30	1,040	EKYB800E□□181MJ20S
	220	10×25	0.060	0.24	1,170	EKYB800E□□221MJ25S
	270	10×30	0.053	0.22	1,350	EKYB800E□□271MJ30S
	270	12.5×20	0.048	0.20	1,430	EKYB800E□□271MK20S
	390	12.5×25	0.039	0.16	1,620	EKYB800E□□391MK25S
	470	12.5×30	0.033	0.14	1,950	EKYB800E□□471MK30S
	470	16×20	0.036	0.15	1,750	EKYB800E□□471ML20S
	560	12.5×35	0.026	0.11	2,250	EKYB800E□□561MK35S
	560	18×20	0.032	0.13	2,100	EKYB800E□□561MM20S
	680	12.5×40	0.024	0.096	2,450	EKYB800E□□681MK40S
	680	16×25	0.028	0.12	2,250	EKYB800E□□681ML25S
	820	16×31.5	0.022	0.088	2,400	EKYB800E□□821MLN3S
	820	18×25	0.027	0.11	2,270	EKYB800E□□821MM25S
	1,000	16×35.5	0.020	0.080	2,600	EKYB800E□□102MLP1S
1,200	16×40	0.018	0.072	2,900	EKYB800E□□122ML40S	
1,200	18×31.5	0.020	0.080	2,550	EKYB800E□□122MMN3S	
1,500	18×35.5	0.018	0.072	3,050	EKYB800E□□152MMP1S	
100	6.8	5×11	0.80	3.2	163	EKYB101E□□6R8ME11D
	15	6.3×11	0.43	1.8	267	EKYB101E□□150MF11D
	27	8×11.5	0.18	0.72	462	EKYB101E□□270MHB5D
	39	8×15	0.14	0.56	585	EKYB101E□□390MH15D
	56	8×20	0.11	0.44	735	EKYB101E□□560MH20D
	56	10×12.5	0.14	0.56	624	EKYB101E□□560MJC5S
	82	10×16	0.10	0.40	780	EKYB101E□□820MJ16S
	100	10×20	0.075	0.30	1,040	EKYB101E□□101MJ20S
	120	10×25	0.060	0.24	1,170	EKYB101E□□121MJ25S
	150	10×30	0.053	0.22	1,350	EKYB101E□□151MJ30S
	180	12.5×20	0.048	0.20	1,430	EKYB101E□□181MK20S
	220	12.5×25	0.039	0.16	1,620	EKYB101E□□221MK25S
	270	12.5×30	0.033	0.14	1,950	EKYB101E□□271MK30S
	270	16×20	0.036	0.15	1,750	EKYB101E□□271ML20S
	330	16×25	0.028	0.12	2,250	EKYB101E□□331ML25S
	390	12.5×35	0.026	0.11	2,250	EKYB101E□□391MK35S
	390	18×20	0.032	0.13	2,100	EKYB101E□□391MM20S
	470	12.5×40	0.024	0.096	2,450	EKYB101E□□471MK40S
470	16×31.5	0.022	0.088	2,400	EKYB101E□□471MLN3S	
560	16×35.5	0.020	0.080	2,600	EKYB101E□□561MLP1S	
560	18×25	0.027	0.11	2,270	EKYB101E□□561MM25S	
680	16×40	0.018	0.072	2,900	EKYB101E□□681ML40S	
680	18×31.5	0.020	0.080	2,550	EKYB101E□□681MMN3S	
820	18×35.5	0.018	0.072	3,050	EKYB101E□□821MMP1S	
1,000	18×40	0.017	0.068	3,510	EKYB101E□□102MM40S	

□□ : Enter the appropriate lead forming or taping code.

◆RATED RIPPLE CURRENT MULTIPLIERS

●Frequency Multipliers

Capacitance (μF)	Frequency (Hz)			
	120	1k	10k	100k
6.8 to 180	0.40	0.75	0.90	1.00
220 to 560	0.50	0.85	0.94	1.00
680 to 1,800	0.60	0.87	0.95	1.00
2,200 to 3,900	0.75	0.90	0.95	1.00
4,700 to	0.85	0.95	0.98	1.00

The endurance of capacitors is reduced with internal heating produced by ripple current at the rate of halving the lifetime with every 5°C rise. When long life performance is required in actual use, the rms ripple current has to be reduced.

Upgrade!

KYA Series

- Downsized from KY series
- Newly innovative electrolyte is employed to minimize impedance
- Endurance with ripple current : 4,000 to 10,000 hours at 105°C
- Non solvent resistant type
- RoHS Compliant

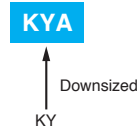

◆ SPECIFICATIONS

Items	Characteristics	
Category	-40 to +105°C	
Temperature Range	-40 to +105°C	
Rated Voltage Range	6.3 to 100V _{dc}	
Capacitance Tolerance	±20% (M) (at 20°C, 120Hz)	
Leakage Current	I=0.01CV or 3μA, whichever is greater. Where, I : Max. leakage current (μA), C : Nominal capacitance (μF), V : Rated voltage (V) (at 20°C after 2 minutes)	
Dissipation Factor (tan δ)	Rated voltage (V _{dc})	6.3V 10V 16V 25V 35V 50V 63V 100V
	tan δ (Max)	0.22 0.19 0.16 0.14 0.12 0.10 0.09 0.08
Low Temperature Characteristics (Max. Impedance Ratio)	When nominal capacitance exceeds 1,000μF, add 0.02 to the value above for each 1,000μF increase. (at 20°C, 120Hz)	
	Rated voltage (V _{dc})	6.3V 10V 16V 25V 35V 50V 63V 100V
	Z(-25°C)/Z(+20°C)	4 3 2 2 2 2 2 2
Endurance	The following specifications shall be satisfied when the capacitors are restored to 20°C after subjected to DC voltage with the rated ripple current is applied (the peak voltage shall not exceed the rated voltage) for the specified period of time at 105°C.	
	Time	6.3 to 10V _{dc} φ5 & 6.3 : 4,000hours φ8 & 10 : 6,000hours φ12.5 to 16 : 8,000hours 16 to 100V _{dc} φ5 & 6.3 : 5,000hours φ8 & 10 : 7,000hours φ12.5 to 16 : 10,000hours
	Capacitance change	≤±25% of the initial value
Shelf Life	The following specifications shall be satisfied when the capacitors are restored to 20°C after exposing them for 500 hours at 105°C without voltage applied. Before the measurement, the capacitor shall be preconditioned by applying voltage according to Item 4.1 of JIS C 5101-4.	
	Capacitance change	≤±25% of the initial value
	D.F. (tan δ)	≤200% of the initial specified value
	Leakage current	≤The initial specified value

◆ DIMENSIONS [mm]

● Terminal Code : E

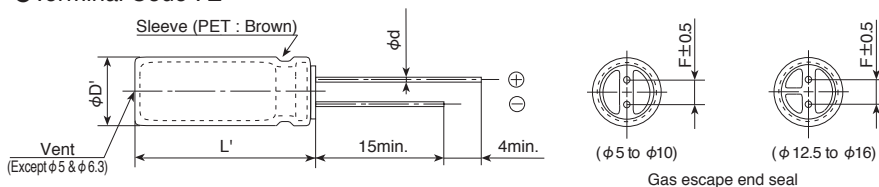

φD	5	6.3	8	10	12.5	16
φd	0.5	0.5	0.6	0.6	0.6	0.8
F	2.0	2.5	3.5	5.0	5.0	7.5
φD'	φD+0.5max.					
L'	L+1.5max.					

◆ PART NUMBERING SYSTEM

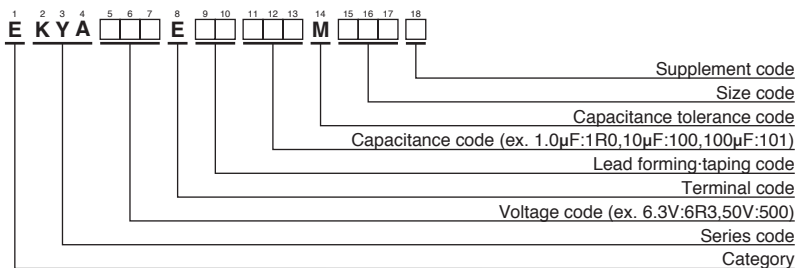

Please refer to "Product code guide (radial lead type)"



Upgrade!

KYA Series

STANDARD RATINGS

Table with columns: WV (Vdc), Cap (µF), Case size (φD×L(mm)), Impedance (Ωmax/100kHz) at 20°C and -10°C, Rated ripple current (mA rms/105°C, 100kHz), Part No. The table is organized into three main sections based on WV (6.3, 10, 25) and further subdivided by Cap and Case size.

□ : Enter the appropriate lead forming or taping code.

◆STANDARD RATINGS

WV (Vdc)	Cap (μF)	Case size φD×L(mm)	Impedance (Ω _{max} /100kHz)		Rated ripple current (mA _{rms} /105°C, 100kHz)	Part No.
			20°C	-10°C		
100	10	6.3×11	0.57	2.3	205	EKYA101E□□100MF11D
	15	6.3×11	0.57	2.3	205	EKYA101E□□150MF11D
	27	8×11.5	0.36	1.4	355	EKYA101E□□270MHB5D
	39	8×15	0.25	1.0	450	EKYA101E□□390MH15D
	47	10×12.5	0.17	0.66	480	EKYA101E□□470MJC5S
	56	8×20	0.19	0.76	565	EKYA101E□□560MH20D
	68	10×16	0.11	0.47	600	EKYA101E□□680MJ16S
	100	10×20	0.084	0.34	800	EKYA101E□□101MJ20S
	150	10×25	0.069	0.28	900	EKYA101E□□151MJ25S
	180	12.5×20	0.062	0.18	1,100	EKYA101E□□181MK20S
	220	12.5×25	0.047	0.14	1,250	EKYA101E□□221MK25S
	330	16×25	0.038	0.12	1,700	EKYA101E□□331ML25S
	470	16×31.5	0.032	0.095	1,850	EKYA101E□□471MLN3S
	560	16×35.5	0.029	0.086	2,000	EKYA101E□□561MLP1S

□□ : Enter the appropriate lead forming or taping code.

◆RATED RIPPLE CURRENT MULTIPLIERS

●Frequency Multipliers

Capacitance (μF)	Frequency (Hz)			
	120	1k	10k	100k
1.0 to 180	0.40	0.75	0.90	1.00
220 to 560	0.50	0.85	0.94	1.00
680 to 1,800	0.60	0.87	0.95	1.00
2,200 to 3,900	0.75	0.90	0.95	1.00
4,700 to	0.85	0.95	0.98	1.00

The endurance of capacitors is reduced with internal heating produced by ripple current at the rate of halving the lifetime with every 5°C rise. When long life performance is required in actual use, the rms ripple current has to be reduced.

KY Series

- Newly innovative electrolyte is employed to minimize ESR
- Endurance with ripple current : 4,000 to 10,000 hours at 105°C
- Non solvent resistant type
- RoHS Compliant

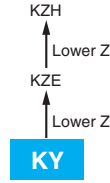

◆ SPECIFICATIONS

Items	Characteristics										
Category Temperature Range	-40 to +105°C										
Rated Voltage Range	6.3 to 100V _{dc}										
Capacitance Tolerance	±20% (M) (at 20°C, 120Hz)										
Leakage Current	I=0.01CV or 3μA, whichever is greater. Where, I : Max. leakage current (μA), C : Nominal capacitance (μF), V : Rated voltage (V) (at 20°C after 2 minutes)										
Dissipation Factor (tan δ)	Rated voltage (V _{dc})	6.3V	10V	16V	25V	35V	50V	63V	80V	100V	
	tan δ (Max)	0.22	0.19	0.16	0.14	0.12	0.10	0.09	0.09	0.08	
Low Temperature Characteristics (Max. Impedance Ratio)	When nominal capacitance exceeds 1,000μF, add 0.02 to the value above for each 1,000μF increase. (at 20°C, 120Hz)										
	Rated voltage (V _{dc})	6.3V	10V	16V	25V	35V	50V	63V	80V	100V	
	Z(-25°C)/Z(+20°C)	4	3	2	2	2	2	2	2	2	
Endurance	The following specifications shall be satisfied when the capacitors are restored to 20°C after subjected to DC voltage with the rated ripple current is applied (the peak voltage shall not exceed the rated voltage) for the specified period of time at 105°C.										
	Time	6.3 to 10V _{dc}	φ 5 & 6.3 : 4,000hours		φ 8 & 10 : 6,000hours		φ 12.5 to 18 : 8,000hours				
		16 to 100V _{dc}	φ 5 & 6.3 : 5,000hours		φ 8 & 10 : 7,000hours		φ 12.5 to 18 : 10,000hours				
	Capacitance change	≤ ±25% of the initial value									
	D.F. (tan δ)	≤ 200% of the initial specified value									
Shelf Life	The following specifications shall be satisfied when the capacitors are restored to 20°C after exposing them for 500 hours at 105°C without voltage applied. Before the measurement, the capacitor shall be preconditioned by applying voltage according to Item 4.1 of JIS C 5101-4.										
	Capacitance change	≤ ±25% of the initial value									
	D.F. (tan δ)	≤ 200% of the initial specified value									
	Leakage current	≤ The initial specified value									

◆ DIMENSIONS [mm]

- Terminal Code : E

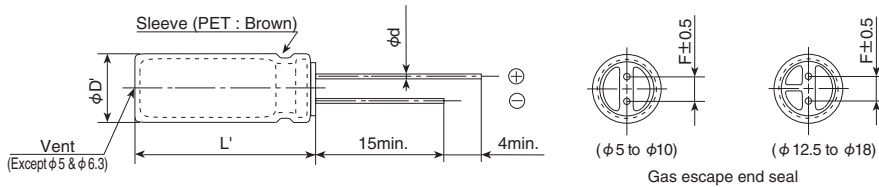

φD	5	6.3	8	10	12.5	16	18
φd	0.5	0.5	0.6	0.6	0.6	0.8	0.8
F	2.0	2.5	3.5	5.0	5.0	7.5	7.5
φD'	φD+0.5max.						
L'	L+1.5max.						

◆ PART NUMBERING SYSTEM

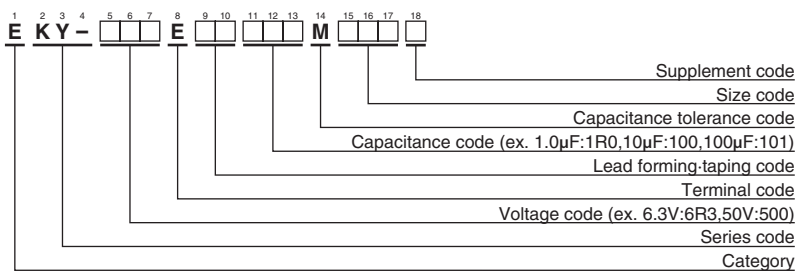

Please refer to "Product code guide (radial lead type)"

◆ STANDARD RATINGS

WV (Vdc)	Cap (μF)	Case size φD×L(mm)	Impedance (Ωmax/100kHz)		Rated ripple current (mArms/ 105°C, 100kHz)	Part No.	WV (Vdc)	Cap (μF)	Case size φD×L(mm)	Impedance (Ωmax/100kHz)		Rated ripple current (mArms/ 105°C, 100kHz)	Part No.		
			20°C	-10°C						20°C	-10°C				
6.3	150	5×11	0.58	2.3	210	EKY-6R3E□□151ME11D	16	1,500	12.5×20	0.035	0.12	1,900	EKY-160E□□152MK20S		
	330	6.3×11	0.22	0.87	340	EKY-6R3E□□331MF11D		1,500	16×15	0.042	0.12	1,940	EKY-160E□□152ML15S		
	680	8×11.5	0.13	0.52	640	EKY-6R3E□□681MHB5D		2,200	12.5×25	0.027	0.089	2,230	EKY-160E□□222MK25S		
	820	10×12.5	0.080	0.32	865	EKY-6R3E□□821MJC5S		2,200	18×15	0.043	0.11	2,210	EKY-160E□□222MM15S		
	1,000	8×15	0.087	0.35	840	EKY-6R3E□□102MH15D		2,700	12.5×30	0.024	0.078	2,650	EKY-160E□□272MK30S		
	1,200	8×20	0.069	0.27	1,050	EKY-6R3E□□122MH20D		2,700	16×20	0.027	0.078	2,530	EKY-160E□□272ML20S		
	1,200	10×16	0.060	0.24	1,210	EKY-6R3E□□122MJ16S		3,300	12.5×35	0.020	0.065	2,880	EKY-160E□□332MK35S		
	1,500	10×20	0.046	0.18	1,400	EKY-6R3E□□152MJ20S		3,900	12.5×40	0.017	0.056	3,350	EKY-160E□□392MK40S		
	1,800	12.5×15	0.049	0.16	1,450	EKY-6R3E□□182MK15S		3,900	16×25	0.021	0.060	2,930	EKY-160E□□392ML25S		
	2,200	10×25	0.042	0.17	1,650	EKY-6R3E□□222MJ25S		3,900	18×20	0.026	0.067	2,860	EKY-160E□□392MM20S		
	2,700	10×30	0.031	0.12	1,910	EKY-6R3E□□272MJ30S		4,700	16×31.5	0.017	0.050	3,450	EKY-160E□□472MLN3S		
	2,700	16×15	0.042	0.12	1,940	EKY-6R3E□□272ML15S		4,700	18×25	0.019	0.049	3,140	EKY-160E□□472MM25S		
	3,300	12.5×20	0.035	0.12	1,900	EKY-6R3E□□332MK20S		5,600	16×35.5	0.015	0.044	3,610	EKY-160E□□562MLP1S		
	3,900	12.5×25	0.027	0.089	2,230	EKY-6R3E□□392MK25S		5,600	18×31.5	0.015	0.040	4,170	EKY-160E□□562MMN3S		
	3,900	18×15	0.043	0.11	2,210	EKY-6R3E□□392MM15S		6,800	16×40	0.013	0.038	4,080	EKY-160E□□682ML40S		
	4,700	12.5×30	0.024	0.078	2,650	EKY-6R3E□□472MK30S		8,200	18×35.5	0.014	0.038	4,220	EKY-160E□□822MMP1S		
	5,600	12.5×35	0.020	0.065	2,880	EKY-6R3E□□562MK35S		10,000	18×40	0.012	0.032	4,280	EKY-160E□□103MM40S		
	5,600	16×20	0.027	0.078	2,530	EKY-6R3E□□562ML20S									
	6,800	12.5×40	0.017	0.056	3,350	EKY-6R3E□□682MK40S									
	6,800	16×25	0.021	0.060	2,930	EKY-6R3E□□682ML25S									
6,800	18×20	0.026	0.067	2,860	EKY-6R3E□□682MM20S										
8,200	16×31.5	0.017	0.050	3,450	EKY-6R3E□□822MLN3S										
10,000	16×35.5	0.015	0.044	3,610	EKY-6R3E□□103MLP1S										
10,000	18×25	0.019	0.049	3,140	EKY-6R3E□□103MM25S										
12,000	16×40	0.013	0.038	4,080	EKY-6R3E□□123ML40S										
12,000	18×31.5	0.015	0.040	4,170	EKY-6R3E□□123MMN3S										
15,000	18×35.5	0.014	0.038	4,220	EKY-6R3E□□153MMP1S										
18,000	18×40	0.012	0.032	4,280	EKY-6R3E□□183MM40S										
10	100	5×11	0.58	2.3	210	EKY-100E□□101ME11D	25	47	5×11	0.58	2.3	210	EKY-250E□□470ME11D		
	220	6.3×11	0.22	0.87	340	EKY-100E□□221MF11D		100	6.3×11	0.22	0.87	340	EKY-250E□□101MF11D		
	470	8×11.5	0.13	0.52	640	EKY-100E□□471MHB5D		220	8×11.5	0.13	0.52	640	EKY-250E□□201MHB5D		
	680	8×15	0.087	0.35	840	EKY-100E□□681MH15D		330	8×15	0.087	0.35	840	EKY-250E□□331MH15D		
	680	10×12.5	0.080	0.32	865	EKY-100E□□681MJC5S		330	10×12.5	0.080	0.32	865	EKY-250E□□331MJC5S		
	1,000	8×20	0.069	0.27	1,050	EKY-100E□□102MH20D		470	8×20	0.069	0.27	1,050	EKY-250E□□471MH20D		
	1,000	10×16	0.060	0.24	1,210	EKY-100E□□102MJ16S		470	10×16	0.060	0.24	1,210	EKY-250E□□471MJ16S		
	1,200	10×20	0.046	0.18	1,400	EKY-100E□□122MJ20S		680	10×20	0.046	0.18	1,400	EKY-250E□□681MJ20S		
	1,500	10×25	0.042	0.17	1,650	EKY-100E□□152MJ25S		680	12.5×15	0.049	0.16	1,450	EKY-250E□□681MK15S		
	1,500	12.5×15	0.049	0.16	1,450	EKY-100E□□152MK15S		820	10×25	0.042	0.17	1,650	EKY-250E□□821MJ25S		
	2,200	10×30	0.031	0.12	1,910	EKY-100E□□222MJ30S		1,000	10×30	0.031	0.12	1,910	EKY-250E□□102MK20S		
	2,200	12.5×20	0.035	0.12	1,900	EKY-100E□□222MK20S		1,000	12.5×20	0.035	0.12	1,900	EKY-250E□□102ML15S		
	2,200	16×15	0.042	0.12	1,940	EKY-100E□□222ML15S		1,200	18×15	0.043	0.11	2,210	EKY-250E□□122MM15S		
	2,700	18×15	0.043	0.11	2,210	EKY-100E□□272MM15S		1,500	12.5×25	0.027	0.089	2,230	EKY-250E□□222MK25S		
	3,300	12.5×25	0.027	0.089	2,230	EKY-100E□□332MK25S		1,800	12.5×30	0.024	0.078	2,650	EKY-250E□□182MK30S		
	3,900	12.5×30	0.024	0.078	2,650	EKY-100E□□392MK30S		1,800	16×20	0.027	0.078	2,530	EKY-250E□□182ML20S		
	3,900	16×20	0.027	0.078	2,530	EKY-100E□□392ML20S		2,200	12.5×35	0.020	0.065	2,880	EKY-250E□□222MK35S		
	4,700	12.5×35	0.020	0.065	2,880	EKY-100E□□472MK35S		2,200	18×20	0.026	0.067	2,860	EKY-250E□□222MM20S		
	5,600	12.5×40	0.017	0.056	3,350	EKY-100E□□562MK40S		2,700	12.5×40	0.017	0.056	3,350	EKY-250E□□272MK40S		
	5,600	16×25	0.021	0.060	2,930	EKY-100E□□562ML25S		2,700	16×25	0.021	0.060	2,930	EKY-250E□□272ML25S		
5,600	18×20	0.026	0.067	2,860	EKY-100E□□562MM20S	3,300	16×31.5	0.017	0.050	3,450	EKY-250E□□332MLN3S				
6,800	16×31.5	0.017	0.050	3,450	EKY-100E□□682MLN3S	3,300	18×25	0.019	0.049	3,140	EKY-250E□□332MM25S				
6,800	18×25	0.019	0.049	3,140	EKY-100E□□682MM25S	3,900	16×35.5	0.015	0.044	3,610	EKY-250E□□392MLP1S				
8,200	16×35.5	0.015	0.044	3,610	EKY-100E□□822MLP1S	3,900	18×31.5	0.015	0.040	4,170	EKY-250E□□392MMN3S				
8,200	18×31.5	0.015	0.040	4,170	EKY-100E□□822MMN3S	4,700	16×40	0.013	0.038	4,080	EKY-250E□□472ML40S				
10,000	16×40	0.013	0.038	4,080	EKY-100E□□103ML40S	4,700	18×35.5	0.014	0.038	4,220	EKY-250E□□472MMP1S				
10,000	18×35.5	0.014	0.038	4,220	EKY-100E□□103MMP1S	5,600	18×40	0.012	0.032	4,280	EKY-250E□□562MM40S				
12,000	18×40	0.012	0.032	4,280	EKY-100E□□123MM40S										
16	56	5×11	0.58	2.3	210	EKY-160E□□560ME11D	35	33	5×11	0.58	2.3	210	EKY-350E□□330ME11D		
	120	6.3×11	0.22	0.87	340	EKY-160E□□121MF11D		56	6.3×11	0.22	0.87	340	EKY-350E□□560MF11D		
	330	8×11.5	0.13	0.52	640	EKY-160E□□331MHB5D		150	8×11.5	0.13	0.52	640	EKY-350E□□151MHB5D		
	470	8×15	0.087	0.35	840	EKY-160E□□471MH15D		220	8×15	0.087	0.35	840	EKY-350E□□221MH15D		
	470	10×12.5	0.080	0.32	865	EKY-160E□□471MJC5S		220	10×12.5	0.080	0.32	865	EKY-350E□□221MJC5S		
	680	8×20	0.069	0.27	1,050	EKY-160E□□681MH20D		270	8×20	0.069	0.27	1,050	EKY-350E□□271MH20D		
	680	10×16	0.060	0.24	1,210	EKY-160E□□681MJ16S		330	10×16	0.060	0.24	1,210	EKY-350E□□331MJ16S		
	1,000	10×20	0.046	0.18	1,400	EKY-160E□□102MJ20S		470	10×20	0.046	0.18	1,400	EKY-350E□□471MJ20S		
	1,000	12.5×15	0.049	0.16	1,450	EKY-160E□□102MK15S		470	12.5×15	0.049	0.16	1,450	EKY-350E□□471MK15S		
	1,200	10×25	0.042	0.17	1,650	EKY-160E□□122MJ25S		560	10×25	0.042	0.17	1,650	EKY-350E□□561MJ25S		
	1,200	10×30	0.031	0.12	1,910	EKY-160E□□152MJ30S		680	10×30	0.031	0.12	1,910	EKY-350E□□681MK20S		
	1,500	10×30	0.031	0.12	1,910	EKY-160E□□152MJ30S		680	16×15	0.042	0.12	1,940	EKY-350E□□681ML15S		
								1,000	12.5×25	0.027	0.089	2,230	EKY-350E□□102MK25S		
								1,000	18×15	0.043	0.11	2,210	EKY-350E□□102MM15S		
						1,200	12.5×30	0.024	0.078	2,650	EKY-350E□□122MK30S				
						1,200	16×20	0.027	0.078	2,530	EKY-350E□□122ML20S				
						1,500	12.5×35	0.020	0.065	2,880	EKY-350E□□152MK35S				
						1,800	12.5×40	0.017	0.056	3,350	EKY-350E□□182MK40S				
						1,800	16×25	0.021	0.060	2,930	EKY-350E□□182ML25S				
						1,800	18×20	0.026	0.067	2,860	EKY-350E□□182MM20S				
						2,200	16×31.5	0.017	0.050	3,450	EKY-350E□□222MLN3S				

□ : Enter the appropriate lead forming or taping code.

◆STANDARD RATINGS

WV (Vdc)	Cap (μF)	Case size φD×L(mm)	Impedance (Ωmax/100kHz)		Rated ripple current (mA rms/105°C/100kHz)	Part No.	
			20°C	-10°C			
35	2,200	18×25	0.019	0.049	3,140	EKY-350E□□222MM25S	
	2,700	16×35.5	0.015	0.044	3,610	EKY-350E□□272MLP1S	
	2,700	18×31.5	0.015	0.040	4,170	EKY-350E□□272MMN3S	
	3,300	16×40	0.013	0.038	4,080	EKY-350E□□332ML40S	
	3,300	18×35.5	0.014	0.038	4,220	EKY-350E□□332MMP1S	
	3,900	18×40	0.012	0.032	4,280	EKY-350E□□392MM40S	
50	1.0	5×11	4.0	16.0	30	EKY-500E□□1R0ME11D	
	2.2	5×11	2.5	10.0	43	EKY-500E□□2R2ME11D	
	3.3	5×11	2.2	8.8	53	EKY-500E□□3R3ME11D	
	4.7	5×11	1.9	7.6	88	EKY-500E□□4R7ME11D	
	10	5×11	1.5	6.0	100	EKY-500E□□100ME11D	
	22	5×11	0.70	2.8	180	EKY-500E□□220ME11D	
	56	6.3×11	0.30	1.2	295	EKY-500E□□560MF11D	
	100	8×11.5	0.17	0.68	555	EKY-500E□□101MHB5D	
	120	8×15	0.12	0.48	730	EKY-500E□□121MH15D	
	150	10×12.5	0.12	0.48	760	EKY-500E□□151MJC5S	
	180	8×20	0.091	0.36	910	EKY-500E□□181MH20D	
	220	10×16	0.084	0.34	1,050	EKY-500E□□221MJ16S	
	270	10×20	0.060	0.24	1,220	EKY-500E□□271MJ20S	
	270	12.5×15	0.061	0.20	1,260	EKY-500E□□271MK15S	
	330	10×25	0.055	0.22	1,440	EKY-500E□□331MJ25S	
	470	10×30	0.043	0.17	1,690	EKY-500E□□471MJ30S	
	470	12.5×20	0.045	0.15	1,660	EKY-500E□□471MK20S	
	470	16×15	0.055	0.17	1,690	EKY-500E□□471ML15S	
	560	12.5×25	0.034	0.11	1,950	EKY-500E□□561MK25S	
	560	18×15	0.054	0.15	1,930	EKY-500E□□561MM15S	
680	12.5×30	0.030	0.10	2,310	EKY-500E□□681MK30S		
820	12.5×35	0.025	0.083	2,510	EKY-500E□□821MK35S		
820	16×20	0.034	0.10	2,210	EKY-500E□□821ML20S		
1,000	12.5×40	0.021	0.069	2,920	EKY-500E□□102MK40S		
1,000	16×25	0.025	0.075	2,555	EKY-500E□□102ML25S		
1,000	18×20	0.036	0.097	2,490	EKY-500E□□102MM20S		
1,200	16×31.5	0.022	0.066	3,010	EKY-500E□□122MLN3S		
1,200	18×25	0.026	0.070	2,740	EKY-500E□□122MM25S		
1,500	16×35.5	0.019	0.057	3,150	EKY-500E□□152MLP1S		
1,800	16×40	0.016	0.048	3,710	EKY-500E□□182ML40S		
1,800	18×31.5	0.021	0.057	3,635	EKY-500E□□182MMN3S		
2,200	18×35.5	0.017	0.046	3,680	EKY-500E□□222MMP1S		
2,700	18×40	0.014	0.038	3,800	EKY-500E□□272MM40S		
63	15	5×11	0.88	3.5	165	EKY-630E□□150ME11D	
	33	6.3×11	0.35	1.4	265	EKY-630E□□330MF11D	
	56	8×11.5	0.22	0.88	500	EKY-630E□□560MHB5D	
	82	8×15	0.16	0.64	665	EKY-630E□□820MH15D	
	82	10×12.5	0.11	0.44	690	EKY-630E□□820MJC5S	
	120	8×20	0.12	0.48	820	EKY-630E□□121MH20D	
	120	10×16	0.076	0.31	950	EKY-630E□□121MJ16S	
	180	10×20	0.056	0.23	1,150	EKY-630E□□181MJ20S	
	180	12.5×16	0.072	0.29	1,150	EKY-630E□□181MK16S	
	220	10×25	0.046	0.19	1,350	EKY-630E□□221MJ25S	
	270	12.5×20	0.041	0.13	1,500	EKY-630E□□271MK20S	
	390	12.5×25	0.031	0.093	1,900	EKY-630E□□391MK25S	
	470	12.5×30	0.028	0.084	2,300	EKY-630E□□471MK30S	
	470	16×20	0.032	0.096	2,000	EKY-630E□□471ML20S	
	560	12.5×35	0.024	0.072	2,500	EKY-630E□□561MK35S	
	680	12.5×40	0.021	0.063	2,800	EKY-630E□□681MK40S	
	63	680	16×25	0.025	0.075	2,600	EKY-630E□□681ML25S
		680	18×20	0.030	0.090	2,500	EKY-630E□□681MM20S
		820	16×31.5	0.021	0.063	2,850	EKY-630E□□821MLN3S
		820	18×25	0.024	0.072	2,800	EKY-630E□□821MM25S
1,000		16×35.5	0.019	0.057	2,900	EKY-630E□□102MLP1S	
1,200		16×40	0.018	0.054	3,400	EKY-630E□□122ML40S	
1,200		18×31.5	0.020	0.060	3,300	EKY-630E□□122MMN3S	
1,500		18×35.5	0.018	0.054	3,400	EKY-630E□□152MMP1S	
1,800		18×40	0.017	0.051	3,500	EKY-630E□□182MM40S	
80		68	10×12.5	0.17	0.66	480	EKY-800E□□680MJC5S
		100	10×16	0.11	0.47	600	EKY-800E□□101MJ16S
		120	10×20	0.084	0.34	800	EKY-800E□□121MJ20S
		150	10×25	0.069	0.28	900	EKY-800E□□151MJ25S
		150	12.5×16	0.11	0.34	750	EKY-800E□□151MK16S
		220	12.5×20	0.062	0.18	1,100	EKY-800E□□221MK20S
		330	12.5×25	0.047	0.14	1,250	EKY-800E□□331MK25S
		330	16×20	0.048	0.15	1,350	EKY-800E□□331ML20S
		390	12.5×30	0.042	0.13	1,500	EKY-800E□□391MK30S
		470	12.5×35	0.036	0.11	1,650	EKY-800E□□471MK35S
		470	16×25	0.038	0.12	1,700	EKY-800E□□471ML25S
	470	18×20	0.045	0.14	1,500	EKY-800E□□471MM20S	
	560	12.5×40	0.032	0.095	1,800	EKY-800E□□561MK40S	
	680	16×31.5	0.032	0.095	1,850	EKY-800E□□681MLN3S	
	680	18×25	0.036	0.11	1,750	EKY-800E□□681MM25S	
	820	16×35.5	0.029	0.086	2,000	EKY-800E□□821MLP1S	
	820	18×31.5	0.030	0.090	1,900	EKY-800E□□821MMN3S	
	1,000	16×40	0.027	0.081	2,200	EKY-800E□□102ML40S	
	1,000	18×35.5	0.027	0.081	2,200	EKY-800E□□102MMP1S	
	1,200	18×40	0.026	0.077	2,700	EKY-800E□□122MM40S	
100	6.8	5×11	1.4	5.6	125	EKY-101E□□6R8ME11D	
	15	6.3×11	0.57	2.3	205	EKY-101E□□150MF11D	
	27	8×11.5	0.36	1.4	355	EKY-101E□□270MHB5D	
	39	8×15	0.25	1.0	450	EKY-101E□□390MH15D	
	47	10×12.5	0.17	0.66	480	EKY-101E□□470MJC5S	
	56	8×20	0.19	0.76	565	EKY-101E□□560MH20D	
	68	10×16	0.11	0.47	600	EKY-101E□□680MJ16S	
	82	10×20	0.084	0.34	800	EKY-101E□□820MJ20S	
	100	12.5×16	0.11	0.34	750	EKY-101E□□101MK16S	
	120	10×25	0.069	0.28	900	EKY-101E□□121MJ25S	
	150	12.5×20	0.062	0.18	1,100	EKY-101E□□151MK20S	
	220	12.5×25	0.047	0.14	1,250	EKY-101E□□221MK25S	
	220	16×20	0.048	0.15	1,350	EKY-101E□□221ML20S	
	270	12.5×30	0.042	0.13	1,500	EKY-101E□□271MK30S	
	330	12.5×35	0.036	0.11	1,650	EKY-101E□□331MK35S	
	330	16×25	0.038	0.12	1,700	EKY-101E□□331ML25S	
	330	18×20	0.045	0.14	1,500	EKY-101E□□331MM20S	
	390	12.5×40	0.032	0.095	1,800	EKY-101E□□391MK40S	
	470	16×31.5	0.032	0.095	1,850	EKY-101E□□471MLN3S	
	470	18×25	0.036	0.11	1,750	EKY-101E□□471MM25S	
560	16×35.5	0.029	0.086	2,000	EKY-101E□□561MLP1S		
560	18×31.5	0.030	0.090	1,900	EKY-101E□□561MMN3S		
680	16×40	0.027	0.081	2,200	EKY-101E□□681MK40S		
680	18×35.5	0.027	0.081	2,200	EKY-101E□□681MMP1S		
820	18×40	0.026	0.077	2,700	EKY-101E□□821MM40S		

□ : Enter the appropriate lead forming or taping code.

◆RATED RIPPLE CURRENT MULTIPLIERS

● Frequency Multipliers

Capacitance (μF)	Frequency (Hz)	120	1k	10k	100k
1.0 to 180		0.40	0.75	0.90	1.00
220 to 560		0.50	0.85	0.94	1.00
680 to 1,800		0.60	0.87	0.95	1.00
2,200 to 3,900		0.75	0.90	0.95	1.00
4,700 to		0.85	0.95	0.98	1.00

The endurance of capacitors is reduced with internal heating produced by ripple current at the rate of halving the lifetime with every 5°C rise. When long life performance is required in actual use, the rms ripple current has to be reduced.

New!

LZA Series

- Adoption of innovative electrolyte and new technologies
- Very low impedance at high frequency
- Endurance with ripple current: 4,000 to 5,000 hours at 105°C
- Solvent resistant type (see PRECAUTIONS AND GUIDELINES)
- RoHS Compliant

LZA

Lower Z
Downsized
LXZ



SPECIFICATIONS

Items	Characteristics					
Category Temperature Range	-55 to +105°C					
Rated Voltage Range	6.3 to 35V _{dc}					
Capacitance Tolerance	±20% (M) (at 20°C, 120Hz)					
Leakage Current	I=0.01CV or 3µA, whichever is greater. Where, I : Max. leakage current (µA), C : Nominal capacitance (µF), V : Rated voltage (V) (at 20°C after 2 minutes)					
Dissipation Factor (tanδ)	Rated voltage (V _{dc})	6.3V	10V	16V	25V	35V
	tanδ (Max.)	0.22	0.19	0.16	0.14	0.12
	When nominal capacitance exceeds 1,000µF, add 0.02 to the value above for each 1,000µF increase. (at 20°C, 120Hz)					
Low Temperature Characteristics (Max. Impedance Ratio)	Rated voltage (V _{dc})	6.3V	10V	16V	25V	35V
	Z(-55°C)/Z(+20°C)	4	3	3	3	3
	(at 120Hz)					
Endurance	The following specifications shall be satisfied when the capacitors are restored to 20°C after subjected to DC voltage with the rated ripple current is applied (the peak voltage shall not exceed the rated voltage) for the specified period of time at 105°C.					
	Time	φ10 : 4,000hours		φ12.5 : 5,000hours		
	Rated voltage	6.3 to 10V _{dc} (φ10)		6.3 to 10V _{dc} (φ12.5)		16 to 35V _{dc}
	Capacitance change	≤±30% of the initial value		≤±20% of the initial value		≤±20% of the initial value
	D.F.(tanδ)	≤300% of the initial specified value		≤200% of the initial specified value		≤200% of the initial specified value
	Leakage current	≤The initial specified value		≤The initial specified value		≤The initial specified value
Shelf Life	The following specifications shall be satisfied when the capacitors are restored to 20°C after exposing them for 1,000 hours at 105°C without voltage applied. Before the measurement, the capacitor shall be preconditioned by applying voltage according to Item 4.1 of JIS C 5101-4.					
	Rated voltage	6.3 to 10V _{dc} (φ10)		6.3 to 10V _{dc} (φ12.5)		16 to 35V _{dc}
	Capacitance change	≤±30% of the initial value		≤±20% of the initial value		≤±20% of the initial value
	D.F.(tanδ)	≤300% of the initial specified value		≤200% of the initial specified value		≤200% of the initial specified value
	Leakage current	≤The initial specified value		≤The initial specified value		≤The initial specified value

DIMENSIONS [mm]

- Terminal Code : E

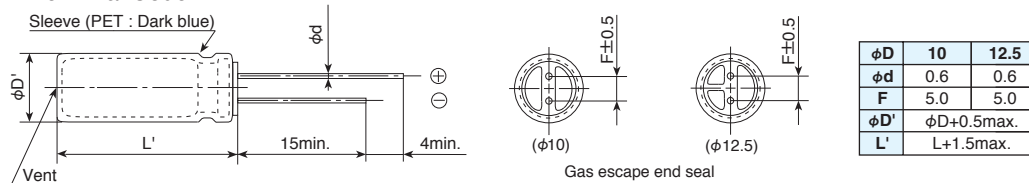

PART NUMBERING SYSTEM

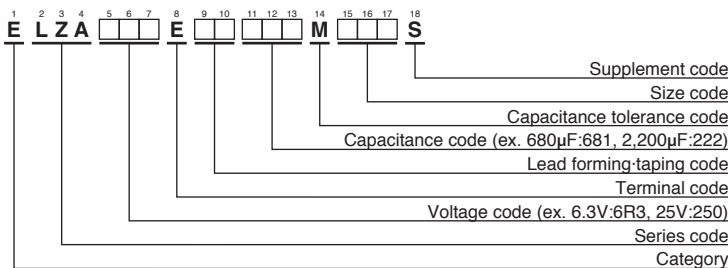

Please refer to "Product code guide (radial lead type)"

New!

LZASeries

◆STANDARD RATINGS

WV (Vdc)	Cap (μF)	Case size φD×L(mm)	Impedance (Ωmax/20°C, 100kHz)	Rated ripple current (mA _{rms} /105°C, 100kHz)	Part No.
6.3	1,500	10×12.5	0.063	960	ELZA6R3E□□152MJC5S
	1,800	10×16	0.049	1,240	ELZA6R3E□□182MJ16S
	2,700	10×20	0.035	1,550	ELZA6R3E□□272MJ20S
	3,300	10×25	0.033	1,740	ELZA6R3E□□332MJ25S
	4,700	12.5×20	0.029	1,890	ELZA6R3E□□472MK20S
	6,800	12.5×25	0.022	2,350	ELZA6R3E□□682MK25S
10	1,000	10×12.5	0.063	960	ELZA100E□□102MJC5S
	1,500	10×16	0.049	1,240	ELZA100E□□152MJ16S
	2,200	10×20	0.035	1,550	ELZA100E□□222MJ20S
	2,700	10×25	0.033	1,740	ELZA100E□□272MJ25S
	3,300	12.5×20	0.029	1,890	ELZA100E□□332MK20S
	4,700	12.5×25	0.022	2,350	ELZA100E□□472MK25S
16	820	10×12.5	0.063	960	ELZA160E□□821MJC5S
	1,000	10×16	0.049	1,240	ELZA160E□□102MJ16S
	1,500	10×20	0.035	1,550	ELZA160E□□152MJ20S
	1,800	10×25	0.033	1,740	ELZA160E□□182MJ25S
	2,200	12.5×20	0.029	1,890	ELZA160E□□222MK20S
	3,300	12.5×25	0.022	2,350	ELZA160E□□332MK25S
25	470	10×12.5	0.063	960	ELZA250E□□471MJC5S
	680	10×16	0.049	1,240	ELZA250E□□681MJ16S
	1,000	10×20	0.035	1,550	ELZA250E□□102MJ20S
	1,200	10×25	0.033	1,740	ELZA250E□□122MJ25S
	1,500	12.5×20	0.029	1,890	ELZA250E□□152MK20S
	2,200	12.5×25	0.022	2,350	ELZA250E□□222MK25S
35	330	10×12.5	0.063	960	ELZA350E□□331MJC5S
	470	10×16	0.049	1,240	ELZA350E□□471MJ16S
	680	10×20	0.035	1,550	ELZA350E□□681MJ20S
	820	10×25	0.033	1,740	ELZA350E□□821MJ25S
	1,000	12.5×20	0.029	1,890	ELZA350E□□102MK20S
	1,500	12.5×25	0.022	2,350	ELZA350E□□152MK25S

□□ : Enter the appropriate lead forming or taping code.

◆RATED RIPPLE CURRENT MULTIPLIERS

●Frequency Multipliers

Capacitance (μF)	Frequency (Hz)			
	120	1k	10k	100k
330 to 470	0.50	0.85	0.94	1.00
680 to 1,800	0.60	0.87	0.95	1.00
2,200 to 3,300	0.75	0.90	0.95	1.00
4,700 to 6,800	0.85	0.95	0.98	1.00

The endurance of capacitors is reduced with internal heating produced by ripple current at the rate of halving the lifetime with every 5°C rise. When long life performance is required in actual use, the rms ripple current has to be reduced.

LXZ Series

- Adoption of innovative electrolyte and new technologies
- Very low impedance at high frequency
- Endurance with ripple current: 2,000 to 8,000 hours at 105°C
- Solvent resistant type (see PRECAUTIONS AND GUIDELINES)
- RoHS Compliant

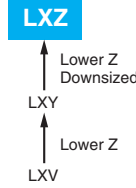

◆SPECIFICATIONS

Items	Characteristics
Category Temperature Range	-55 to +105°C
Rated Voltage Range	6.3 to 63V _{dc}
Capacitance Tolerance	±20% (M) (at 20°C, 120Hz)
Leakage Current	I=0.01CV or 3µA, whichever is greater. Where, I : Max. leakage current (µA), C : Nominal capacitance (µF), V : Rated voltage (V) (at 20°C after 2 minutes)
Dissipation Factor (tanδ)	Rated voltage (V _{dc})
	tan δ (Max.)
Endurance	When nominal capacitance exceeds 1,000µF, add 0.02 to the value above for each 1,000µF increase. (at 20°C, 120Hz)
	The following specifications shall be satisfied when the capacitors are restored to 20°C after subjected to DC voltage with the rated ripple current is applied (the peak voltage shall not exceed the rated voltage) for the specified period of time at 105°C.
	Time
	Capacitance change
Shelf Life	D.F. (tan δ)
	Leakage current
	The following specifications shall be satisfied when the capacitors are restored to 20°C after exposing them for 1,000 hours at 105°C without voltage applied. Before the measurement, the capacitor shall be preconditioned by applying voltage according to Item 4.1 of JIS C 5101-4.
	Capacitance change
	D.F. (tan δ)
	Leakage current

◆DIMENSIONS [mm]

●Terminal Code : E

Sleeve (PET : Dark blue)

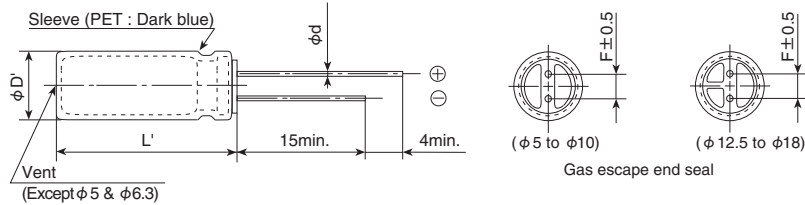

φD	5	6.3	8	10	12.5	16	18
φd	0.5	0.5	0.6	0.6	0.6	0.8	0.8
F	2.0	2.5	3.5	5.0	5.0	7.5	7.5
φD'	φD+0.5max.						
L'	L+1.5max.						

◆PART NUMBERING SYSTEM

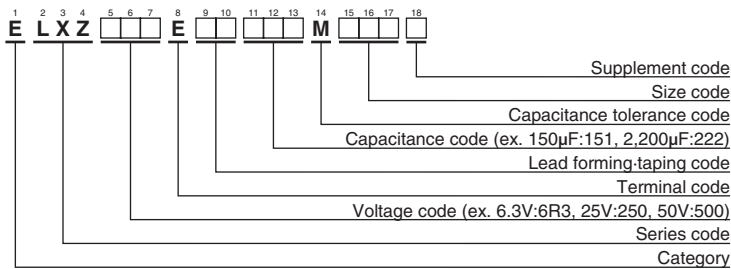

Please refer to "Product code guide (radial lead type)"



◆STANDARD RATINGS

Table with columns: WV (Vdc), Cap (µF), Case size (φD×L(mm)), Impedance (Ω max/100kHz) at 20°C and -10°C, Rated ripple current (mA rms/105°C, 100kHz), Part No. The table is organized into three main sections for WV ratings of 6.3V, 10V, and 16V, each with sub-sections for different capacitance values and case sizes.

□ : Enter the appropriate lead forming or taping code.

◆STANDARD RATINGS

WV (Vdc)	Cap (μF)	Case size φ D × L (mm)	Impedance (Ω max/100kHz)		Rated ripple current (mA _{rms} / 105°C, 100kHz)	Part No.	WV (Vdc)	Cap (μF)	Case size φ D × L (mm)	Impedance (Ω max/100kHz)		Rated ripple current (mA _{rms} / 105°C, 100kHz)	Part No.
			20°C	-10°C						20°C	-10°C		
			50	120						8 × 15	0.16		
120	10 × 12.5	0.16		0.32	620	ELXZ500E□□121MJC5S	68	8 × 12	0.34	0.75	405	ELXZ630E□□680MH12D	
180	8 × 20	0.12		0.24	730	ELXZ500E□□181MH20D	100	8 × 15	0.27	0.65	535	ELXZ630E□□101MH15D	
180	10 × 16	0.13		0.26	850	ELXZ500E□□181MJ16S	100	10 × 12.5	0.255	0.51	540	ELXZ630E□□101MJC5S	
220	10 × 20	0.088		0.18	1,050	ELXZ500E□□221MJ20S	120	10 × 16	0.19	0.38	600	ELXZ630E□□121MJ16S	
330	10 × 25	0.073		0.15	1,250	ELXZ500E□□331MJ25S	150	8 × 20	0.21	0.52	690	ELXZ630E□□151MH20D	
390	10 × 30	0.054		0.11	1,500	ELXZ500E□□391MJ30S	180	10 × 20	0.145	0.29	890	ELXZ630E□□181MJ20S	
390	12.5 × 20	0.059		0.12	1,480	ELXZ500E□□391MK20S	220	10 × 25	0.13	0.26	1,050	ELXZ630E□□221MJ25S	
560	12.5 × 25	0.044		0.088	1,840	ELXZ500E□□561MK25S	330	10 × 30	0.090	0.18	1,300	ELXZ630E□□331MJ30S	
680	12.5 × 30	0.039		0.078	2,220	ELXZ500E□□681MK30S	330	12.5 × 20	0.085	0.17	1,290	ELXZ630E□□331MK20S	
680	16 × 20	0.048		0.096	1,840	ELXZ500E□□681ML20S	390	12.5 × 25	0.070	0.14	1,720	ELXZ630E□□391MK25S	
820	12.5 × 35	0.033		0.066	2,290	ELXZ500E□□821MK35S	470	12.5 × 30	0.055	0.11	2,090	ELXZ630E□□471MK30S	
820	18 × 20	0.042		0.084	1,980	ELXZ500E□□821MM20S	470	16 × 20	0.059	0.12	1,770	ELXZ630E□□471ML20S	
1,000	12.5 × 40	0.029		0.058	2,500	ELXZ500E□□102MK40S	680	12.5 × 35	0.047	0.094	2,270	ELXZ630E□□681MK35S	
1,000	16 × 25	0.034		0.068	2,240	ELXZ500E□□102ML25S	680	16 × 25	0.050	0.10	2,160	ELXZ630E□□681ML25S	
1,200	16 × 30	0.028		0.056	2,700	ELXZ500E□□122ML30S	680	18 × 20	0.055	0.11	2,290	ELXZ630E□□681MM20S	
1,200	18 × 25	0.029		0.058	2,610	ELXZ500E□□122MM25S	820	12.5 × 40	0.042	0.084	2,560	ELXZ630E□□821MK40S	
1,500	16 × 35	0.025		0.050	2,800	ELXZ500E□□152ML35S	820	16 × 30	0.043	0.086	2,670	ELXZ630E□□821ML30S	
1,800	16 × 40	0.021		0.042	3,200	ELXZ500E□□182ML40S	820	18 × 25	0.043	0.086	2,590	ELXZ630E□□821MM25S	
1,800	18 × 30	0.025		0.050	3,000	ELXZ500E□□182MM30S	1,000	16 × 35	0.036	0.072	2,770	ELXZ630E□□102ML35S	
2,200	18 × 35	0.023	0.046	3,100	ELXZ500E□□222MM35S	1,200	16 × 40	0.030	0.060	2,850	ELXZ630E□□122ML40S		
2,700	18 × 40	0.020	0.040	3,400	ELXZ500E□□272MM40S	1,200	18 × 30	0.032	0.064	2,950	ELXZ630E□□122MM30S		
63	12	5 × 11.5	1.9	4.0	145	ELXZ630E□□120MEB5D	1,500	18 × 35	0.030	0.060	3,100	ELXZ630E□□152MM35S	
	22	6.3 × 11.5	1.0	2.0	240	ELXZ630E□□220MFB5D	1,800	18 × 40	0.025	0.050	3,210	ELXZ630E□□182MM40S	

□□ : Enter the appropriate lead forming or taping code.

◆RATED RIPPLE CURRENT MULTIPLIERS

●Frequency Multipliers

Capacitance (μF)	Frequency (Hz)			
	120	1k	10k	100k
12 to 180	0.40	0.75	0.90	1.00
220 to 560	0.50	0.85	0.94	1.00
680 to 1,800	0.60	0.87	0.95	1.00
2,200 to 3,900	0.75	0.90	0.95	1.00
4,700 to 18,000	0.85	0.95	0.98	1.00

The endurance of capacitors is reduced with internal heating produced by ripple current at the rate of halving the lifetime with every 5°C rise. When long life performance is required in actual use, the rms ripple current has to be reduced.

LXY Series

- Adoption of innovative electrolyte and new technologies
- Endurance with ripple current : 2,000 to 8,000 hours at 105°C
- Solvent resistant type (see PRECAUTIONS AND GUIDELINES)
- RoHS Compliant



◆ SPECIFICATIONS

Items	Characteristics	
Category	-55 to +105°C	
Temperature Range	-55 to +105°C	
Rated Voltage Range	10 to 63V _{dc}	
Capacitance Tolerance	±20% (M) (at 20°C, 120Hz)	
Leakage Current	I=0.01CV or 3μA, whichever is greater. Where, I : Max. leakage current (μA), C : Nominal capacitance (μF), V : Rated voltage (V) (at 20°C after 2 minutes)	
Dissipation Factor (tanδ)	Rated voltage (V _{dc})	10V 16V 25V 35V 50V 63V
	tanδ (Max.)	0.19 0.16 0.14 0.12 0.10 0.10
	When nominal capacitance exceeds 1,000μF, add 0.02 to the value above for each 1,000μF increase. (at 20°C, 120Hz)	
Low Temperature Characteristics (Max. Impedance Ratio)	Z(-55°C)/Z(+20°C)	10V _{dc} to 50V _{dc} : 3max. 63V _{dc} : 6max. (at 120Hz)
Endurance	The following specifications shall be satisfied when the capacitors are restored to 20°C after subjected to DC voltage with the rated ripple current is applied (the peak voltage shall not exceed the rated voltage) for the specified period of time at 105°C.	
	Time	φ5 & 6.3 : 2,000hours φ8 : 3,000hours φ10 : 5,000hours φ12.5 : 7,000hours φ16 & 18 : 8,000hours
	Capacitance change	≤ ±20% of the initial value
	D.F. (tanδ)	≤ 200% of the initial specified value
	Leakage current	≤ The initial specified value
Shelf Life	The following specifications shall be satisfied when the capacitors are restored to 20°C after exposing them for 1,000 hours at 105°C without voltage applied. Before the measurement, the capacitor shall be preconditioned by applying voltage according to Item 4.1 of JIS C 5101-4.	
	Capacitance change	≤ ±20% of the initial value
	D.F. (tanδ)	≤ 200% of the initial specified value
	Leakage current	≤ The initial specified value

◆ DIMENSIONS [mm]

- Terminal Code : E

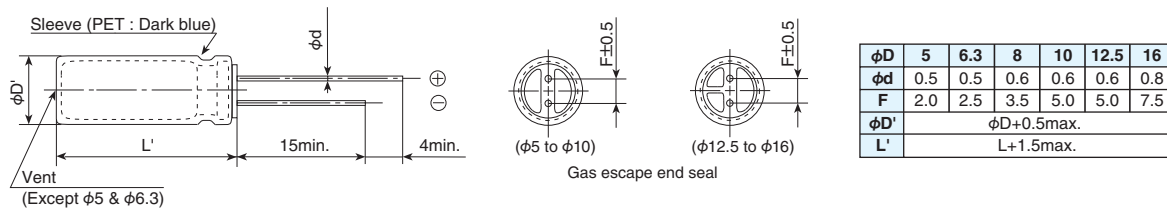

◆ PART NUMBERING SYSTEM

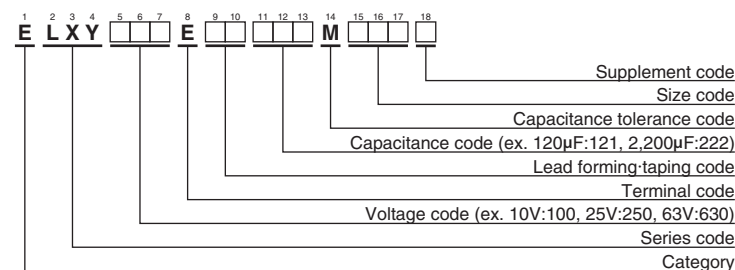

Please refer to "Product code guide (radial lead type)"

◆ RATED RIPPLE CURRENT MULTIPLIERS

- Frequency Multipliers

Capacitance (μF)	Frequency (Hz)			
	120	1k	10k	100k
10 to 180	0.40	0.75	0.90	1.00
220 to 560	0.50	0.85	0.94	1.00
680 to 1,800	0.60	0.87	0.95	1.00
2,200 to 3,900	0.75	0.90	0.95	1.00
4,700 to 8,200	0.85	0.95	0.98	1.00

The endurance of capacitors is reduced with internal heating produced by ripple current at the rate of halving the lifetime with every 5°C rise. When long life performance is required in actual use, the rms ripple current has to be reduced.



◆STANDARD RATINGS

WV (Vdc)	Cap (μF)	Case size φD×L(mm)	Impedance (Ωmax/100kHz)		Rated ripple current (mA rms/105°C, 100kHz)	Part No.	WV (Vdc)	Cap (μF)	Case size φD×L(mm)	Impedance (Ωmax/100kHz)		Rated ripple current (mA rms/105°C, 100kHz)	Part No.
			20°C	-10°C						20°C	-10°C		
10	82	5 × 11.5	0.75	1.5	163	ELXY100E□□820MEB5D	35	27	5 × 11.5	0.75	1.5	163	ELXY350E□□270MEB5D
	180	6.3 × 11.5	0.35	0.70	273	ELXY100E□□181MFB5D		56	6.3 × 11.5	0.35	0.70	273	ELXY350E□□560MFB5D
	220	6.3 × 15	0.25	0.50	390	ELXY100E□□221MF15D		82	6.3 × 15	0.25	0.50	390	ELXY350E□□820MF15D
	330	8 × 12	0.17	0.34	445	ELXY100E□□331MH12D		120	8 × 12	0.17	0.34	445	ELXY350E□□121MH12D
	390	10 × 12.5	0.12	0.24	625	ELXY100E□□391MJC5S		120	10 × 12.5	0.12	0.24	625	ELXY350E□□331MJC5S
	470	8 × 15	0.13	0.26	555	ELXY100E□□471MH15D		180	8 × 15	0.13	0.26	555	ELXY350E□□181MH15D
	680	8 × 20	0.095	0.19	740	ELXY100E□□681MH20D		220	8 × 20	0.095	0.19	740	ELXY350E□□221MH20D
	680	10 × 16	0.084	0.17	825	ELXY100E□□681MJ16S		220	10 × 16	0.084	0.17	825	ELXY350E□□221MJ16S
	1,000	10 × 20	0.062	0.13	1,040	ELXY100E□□102MJ20S		330	10 × 20	0.062	0.13	1,040	ELXY350E□□331MJ20S
	1,200	10 × 25	0.052	0.11	1,260	ELXY100E□□122MJ25S		390	10 × 25	0.052	0.11	1,260	ELXY350E□□391MJ25S
	1,500	10 × 30	0.044	0.088	1,440	ELXY100E□□152MJ30S		560	10 × 30	0.044	0.088	1,440	ELXY350E□□561MJ30S
	1,800	12.5 × 20	0.046	0.092	1,340	ELXY100E□□182MK20S		560	12.5 × 20	0.046	0.092	1,340	ELXY350E□□561MK20S
	2,200	12.5 × 25	0.034	0.068	1,690	ELXY100E□□222MK25S		680	12.5 × 25	0.034	0.068	1,690	ELXY350E□□681MK25S
	2,700	12.5 × 30	0.030	0.060	1,950	ELXY100E□□272MK30S		1,000	12.5 × 30	0.030	0.060	1,950	ELXY350E□□102MK30S
	3,300	12.5 × 35	0.024	0.048	2,220	ELXY100E□□332MK35S		1,000	16 × 20	0.038	0.076	1,630	ELXY350E□□102ML20S
	3,300	16 × 20	0.038	0.076	1,630	ELXY100E□□332ML20S		1,200	12.5 × 35	0.024	0.048	2,220	ELXY350E□□122MK35S
	3,900	12.5 × 40	0.022	0.044	2,390	ELXY100E□□392MK40S		1,200	16 × 25	0.028	0.056	2,070	ELXY350E□□122ML25S
	3,900	16 × 25	0.028	0.056	2,070	ELXY100E□□392ML25S		1,500	12.5 × 40	0.022	0.044	2,390	ELXY350E□□152MK40S
5,600	16 × 30	0.025	0.050	2,350	ELXY100E□□562ML30S	1,800	16 × 30	0.025	0.050	2,350	ELXY350E□□182ML30S		
6,800	16 × 35	0.022	0.044	2,550	ELXY100E□□682ML35S	2,200	16 × 35	0.022	0.044	2,550	ELXY350E□□222ML35S		
8,200	16 × 40	0.018	0.036	2,900	ELXY100E□□822ML40S	2,700	16 × 40	0.018	0.036	2,900	ELXY350E□□272ML40S		
16	56	5 × 11.5	0.75	1.5	163	ELXY160E□□560MEB5D	50	18	5 × 11.5	1.2	2.4	129	ELXY500E□□180MEB5D
	120	6.3 × 11.5	0.35	0.70	273	ELXY160E□□121MFB5D		39	6.3 × 11.5	0.54	1.1	219	ELXY500E□□390MFB5D
	180	6.3 × 15	0.25	0.50	390	ELXY160E□□181MF15D		56	6.3 × 15	0.34	0.68	310	ELXY500E□□560MF15D
	270	8 × 12	0.17	0.34	445	ELXY160E□□271MH12D		68	8 × 12	0.30	0.60	340	ELXY500E□□680MH12D
	270	10 × 12.5	0.12	0.24	625	ELXY160E□□271MJC5S		82	8 × 15	0.20	0.40	470	ELXY500E□□820MH15D
	390	8 × 15	0.13	0.26	555	ELXY160E□□331MH15D		82	10 × 12.5	0.20	0.40	480	ELXY500E□□820MJC5S
	470	8 × 20	0.095	0.19	740	ELXY160E□□471MH20D		120	8 × 20	0.14	0.28	610	ELXY500E□□121MH20D
	470	10 × 16	0.084	0.17	825	ELXY160E□□471MJ16S		120	10 × 16	0.13	0.26	755	ELXY500E□□121MJ16S
	680	10 × 20	0.062	0.13	1,040	ELXY160E□□681MJ20S		180	10 × 20	0.088	0.18	945	ELXY500E□□181MJ20S
	820	10 × 25	0.052	0.11	1,260	ELXY160E□□821MJ25S		220	10 × 25	0.073	0.15	1,150	ELXY500E□□221MJ25S
	1,200	10 × 30	0.044	0.088	1,440	ELXY160E□□122MJ30S		330	10 × 30	0.054	0.11	1,260	ELXY500E□□331MJ30S
	1,200	12.5 × 20	0.046	0.092	1,340	ELXY160E□□122MK20S		330	12.5 × 20	0.059	0.12	1,190	ELXY500E□□331MK20S
	1,500	12.5 × 25	0.034	0.068	1,690	ELXY160E□□152MK25S		470	12.5 × 25	0.044	0.088	1,490	ELXY500E□□471MK25S
	2,200	12.5 × 30	0.030	0.060	1,950	ELXY160E□□222MK30S		560	12.5 × 30	0.039	0.078	1,720	ELXY500E□□561MK30S
	2,200	16 × 20	0.038	0.076	1,630	ELXY160E□□222ML20S		680	12.5 × 35	0.033	0.066	1,890	ELXY500E□□681MK35S
	2,700	12.5 × 35	0.024	0.048	2,220	ELXY160E□□272MK35S		680	16 × 20	0.050	0.10	1,420	ELXY500E□□681ML20S
	2,700	16 × 25	0.028	0.056	2,070	ELXY160E□□272ML25S		820	12.5 × 40	0.029	0.058	2,030	ELXY500E□□821MK40S
	3,300	12.5 × 40	0.022	0.044	2,390	ELXY160E□□332MK40S		820	16 × 25	0.034	0.068	1,880	ELXY500E□□821ML25S
3,900	16 × 30	0.025	0.050	2,350	ELXY160E□□392ML30S	1,000	16 × 30	0.030	0.060	2,150	ELXY500E□□102ML30S		
4,700	16 × 35	0.022	0.044	2,550	ELXY160E□□472ML35S	1,200	16 × 35	0.027	0.054	2,320	ELXY500E□□122ML35S		
5,600	16 × 40	0.018	0.036	2,900	ELXY160E□□562ML40S	1,500	16 × 40	0.024	0.048	2,540	ELXY500E□□152ML40S		
25	39	5 × 11.5	0.75	1.5	163	ELXY250E□□390MEB5D	63	10	5 × 11.5	1.9	4.8	103	ELXY630E□□100MEB5D
	82	6.3 × 11.5	0.35	0.70	273	ELXY250E□□820MFB5D		18	6.3 × 11.5	1.0	2.5	161	ELXY630E□□180MFB5D
	120	6.3 × 15	0.25	0.50	390	ELXY250E□□121MF15D		33	6.3 × 15	0.61	1.6	233	ELXY630E□□330MF15D
	150	8 × 12	0.17	0.34	445	ELXY250E□□151MH12D		47	8 × 12	0.47	1.2	274	ELXY630E□□470MH12D
	180	10 × 12.5	0.12	0.24	625	ELXY250E□□181MJC5S		56	10 × 12.5	0.27	0.68	418	ELXY630E□□560MJC5S
	220	8 × 15	0.13	0.26	555	ELXY250E□□221MH15D		68	8 × 15	0.34	0.85	360	ELXY630E□□680MH15D
	330	8 × 20	0.095	0.19	740	ELXY250E□□331MH20D		68	10 × 16	0.21	0.53	525	ELXY630E□□680MJ16S
	330	10 × 16	0.084	0.17	825	ELXY250E□□331MJ16S		82	8 × 20	0.21	0.53	500	ELXY630E□□820MH20D
	470	10 × 20	0.062	0.13	1,040	ELXY250E□□471MJ20S		120	10 × 20	0.16	0.40	650	ELXY630E□□121MJ20S
	560	10 × 25	0.052	0.11	1,260	ELXY250E□□561MJ25S		150	10 × 25	0.13	0.33	783	ELXY630E□□151MJ25S
	820	10 × 30	0.044	0.088	1,440	ELXY250E□□821MJ30S		180	10 × 30	0.10	0.25	960	ELXY630E□□181MJ30S
	820	12.5 × 20	0.046	0.092	1,340	ELXY250E□□821MK20S		220	12.5 × 20	0.11	0.28	870	ELXY630E□□221MK20S
	1,000	12.5 × 25	0.034	0.068	1,690	ELXY250E□□102MK25S		270	12.5 × 25	0.074	0.19	1,150	ELXY630E□□271MK25S
	1,500	12.5 × 30	0.030	0.060	1,950	ELXY250E□□152MK30S		330	16 × 20	0.085	0.22	1,100	ELXY630E□□331ML20S
	1,500	16 × 20	0.038	0.076	1,630	ELXY250E□□152ML20S		390	12.5 × 30	0.068	0.17	1,280	ELXY630E□□391MK30S
	1,800	12.5 × 35	0.024	0.048	2,220	ELXY250E□□182MK35S		470	12.5 × 35	0.063	0.16	1,390	ELXY630E□□471MK35S
	1,800	16 × 25	0.028	0.056	2,070	ELXY250E□□182ML25S		470	16 × 25	0.055	0.14	1,480	ELXY630E□□471ML25S
	2,200	12.5 × 40	0.022	0.044	2,390	ELXY250E□□222MK40S		560	12.5 × 40	0.051	0.13	1,530	ELXY630E□□561MK40S
2,700	16 × 30	0.025	0.050	2,350	ELXY250E□□272ML30S	680	16 × 30	0.046	0.12	1,720	ELXY630E□□681ML30S		
3,300	16 × 35	0.022	0.044	2,550	ELXY250E□□332ML35S	820	16 × 35	0.040	0.10	1,910	ELXY630E□□821ML35S		
3,900	16 × 40	0.018	0.036	2,900	ELXY250E□□392ML40S	1,000	16 × 40	0.036	0.09	2,070	ELXY630E□□102ML40S		

□□ : Enter the appropriate lead forming or taping code.

LXV Series

- Low impedance
- Endurance with ripple current : 2,000 to 5,000 hours at 105°C
- Solvent resistant type (see PRECAUTIONS AND GUIDELINES)
- RoHS Compliant

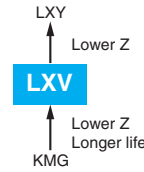

◆ SPECIFICATIONS

Items	Characteristics	
Category	-55 to +105°C	
Temperature Range		
Rated Voltage Range	6.3 to 100V _{dc}	
Capacitance Tolerance	±20% (M) (at 20°C, 120Hz)	
Leakage Current	I=0.01CV or 3μA, whichever is greater. Where, I : Max. leakage current (μA), C : Nominal capacitance (μF), V : Rated voltage (V) (at 20°C after 2 minutes)	
Dissipation Factor (tanδ)	Rated voltage (V _{dc})	6.3V 10V 16V 25V 35V 50V 63V 80V 100V
	tanδ (Max.)	0.22 0.19 0.16 0.14 0.12 0.10 0.10 0.09 0.08
	When nominal capacitance exceeds 1,000μF, add 0.02 to the value above for each 1,000μF increase. (at 20°C, 120Hz)	
Low Temperature Characteristics	Capacitance change ΔC (-55°C/+20°C)	0.7min.
	Max. impedance ratio (-55°C/+20°C)	3max.(6.3V _{dc} : 4max.) (at 120Hz)
Endurance	The following specifications shall be satisfied when the capacitors are restored to 20°C after subjected to DC voltage with the rated ripple current is applied (the peak voltage shall not exceed the rated voltage) for the specified period of time at 105°C.	
	Time	φ5 to 6.3 : 2,000hours φ8 & 10 : 3,000hours φ12.5 to φ18 : 5,000hours
	Capacitance change	≤±20% of the initial value
	D.F. (tanδ)	≤200% of the initial specified value
	Leakage current	≤The initial specified value
Shelf Life	The following specifications shall be satisfied when the capacitors are restored to 20°C after exposing them for 1,000 hours at 105°C without voltage applied. Before the measurement, the capacitor shall be preconditioned by applying voltage according to Item 4.1 of JIS C 5101-4.	
	Capacitance change	≤±20% of the initial value
	D.F. (tanδ)	≤200% of the initial specified value
	Leakage current	≤The initial specified value

◆ DIMENSIONS [mm]

- Terminal Code : E

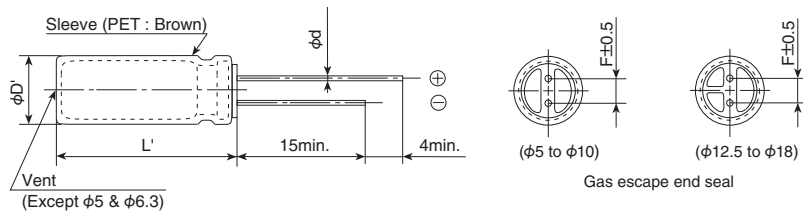

φD	5	6.3	8	10	12.5	16	18
φd	0.5	0.5	0.6	0.6	0.6	0.8	0.8
F	2.0	2.5	3.5	5.0	5.0	7.5	7.5
φD'	φD+0.5max.						
L'	L+1.5max.						

◆ PART NUMBERING SYSTEM

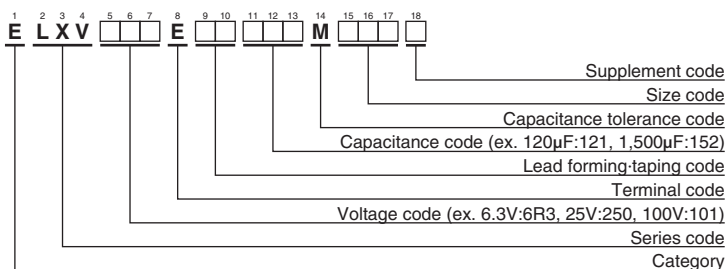

Please refer to "Product code guide (radial lead type)"

◆STANDARD RATINGS

WV (Vdc)	Cap (μF)	Case size φD×L(mm)	Impedance (Ωmax/100kHz)		Rated ripple current (mA rms/105°C, 100kHz)	Part No.	WV (Vdc)	Cap (μF)	Case size φD×L(mm)	Impedance (Ωmax/100kHz)		Rated ripple current (mA rms/105°C, 100kHz)	Part No.
			20°C	-10°C						20°C	-10°C		
6.3	120	5 × 11.5	0.72	1.8	165	ELXV6R3E□□121MEB5D	16	2,700	12.5 × 35	0.027	0.068	2,230	ELXV160E□□272MK35S
	220	6.3 × 11.5	0.38	0.95	255	ELXV6R3E□□221MFB5D		2,700	16 × 25	0.028	0.070	2,190	ELXV160E□□272ML25S
	330	6.3 × 15	0.27	0.68	330	ELXV6R3E□□331MF15D		3,300	12.5 × 40	0.024	0.060	2,460	ELXV160E□□332MK40S
	390	8 × 12	0.20	0.50	415	ELXV6R3E□□391MH12D		3,300	18 × 20	0.036	0.090	1,940	ELXV160E□□332MM20S
	470	10 × 12.5	0.12	0.30	635	ELXV6R3E□□471MJC5S		3,900	16 × 30	0.025	0.063	2,510	ELXV160E□□392ML30S
	560	8 × 15	0.16	0.40	495	ELXV6R3E□□561MH15D		3,900	18 × 25	0.027	0.068	2,350	ELXV160E□□392MM25S
	680	10 × 16	0.084	0.21	825	ELXV6R3E□□681MJ16S		4,700	16 × 35	0.022	0.055	2,770	ELXV160E□□472ML35S
	820	8 × 20	0.11	0.28	640	ELXV6R3E□□821MH20D		4,700	18 × 30	0.024	0.060	2,720	ELXV160E□□472MM30S
	1,200	10 × 20	0.062	0.16	1,060	ELXV6R3E□□122MJ20S		5,600	16 × 40	0.018	0.045	3,110	ELXV160E□□562ML40S
	1,500	10 × 25	0.052	0.13	1,260	ELXV6R3E□□152MJ25S		6,800	18 × 35	0.021	0.053	3,050	ELXV160E□□682MM35S
	2,200	10 × 30	0.044	0.11	1,450	ELXV6R3E□□222MJ30S		8,200	18 × 40	0.017	0.043	3,300	ELXV160E□□822MM40S
	2,200	12.5 × 20	0.046	0.12	1,360	ELXV6R3E□□222MK20S		39	5 × 11.5	0.72	1.8	165	ELXV250E□□390MEB5D
	2,700	12.5 × 25	0.034	0.085	1,700	ELXV6R3E□□272MK25S		82	6.3 × 11.5	0.38	0.95	255	ELXV250E□□820MFB5D
	3,900	12.5 × 30	0.030	0.075	1,980	ELXV6R3E□□392MK30S		120	6.3 × 15	0.27	0.68	330	ELXV250E□□121MF15D
	3,900	16 × 20	0.038	0.095	1,770	ELXV6R3E□□392ML20S		150	8 × 12	0.20	0.50	415	ELXV250E□□151MH12D
4,700	12.5 × 35	0.027	0.068	2,230	ELXV6R3E□□472MK35S	180	10 × 12.5	0.12	0.30	635	ELXV250E□□181MJC5S		
5,600	12.5 × 40	0.024	0.060	2,460	ELXV6R3E□□562MK40S	220	8 × 15	0.16	0.40	495	ELXV250E□□221MH15D		
5,600	16 × 25	0.028	0.070	2,190	ELXV6R3E□□562ML25S	330	8 × 20	0.11	0.28	640	ELXV250E□□331MH20D		
5,600	18 × 20	0.036	0.090	1,940	ELXV6R3E□□562MM20S	330	10 × 16	0.084	0.21	825	ELXV250E□□331MJ16S		
6,800	16 × 30	0.025	0.063	2,510	ELXV6R3E□□682ML30S	470	10 × 20	0.062	0.16	1,060	ELXV250E□□471MJC5S		
6,800	18 × 25	0.027	0.068	2,350	ELXV6R3E□□682MM25S	560	10 × 25	0.052	0.13	1,260	ELXV250E□□561MJ25S		
8,200	16 × 35	0.022	0.055	2,770	ELXV6R3E□□822ML35S	820	10 × 30	0.044	0.11	1,450	ELXV250E□□821MJ30S		
10,000	16 × 40	0.018	0.045	3,110	ELXV6R3E□□103ML40S	820	12.5 × 20	0.046	0.12	1,360	ELXV250E□□821MK20S		
10,000	18 × 30	0.024	0.060	2,720	ELXV6R3E□□103MM30S	1,000	12.5 × 25	0.034	0.085	1,700	ELXV250E□□102MK25S		
12,000	18 × 35	0.021	0.053	3,050	ELXV6R3E□□123MM35S	1,500	12.5 × 30	0.030	0.075	1,980	ELXV250E□□152MK30S		
15,000	18 × 40	0.017	0.043	3,300	ELXV6R3E□□153MM40S	1,500	16 × 20	0.038	0.095	1,770	ELXV250E□□152ML20S		
	82	5 × 11.5	0.72	1.8	165	ELXV100E□□820MEB5D	1,800	12.5 × 35	0.027	0.068	2,230	ELXV250E□□182MK35S	
	180	6.3 × 11.5	0.38	0.95	255	ELXV100E□□181MFB5D	1,800	16 × 25	0.028	0.070	2,190	ELXV250E□□182ML25S	
	270	6.3 × 15	0.27	0.68	330	ELXV100E□□271MF15D	2,200	12.5 × 40	0.024	0.060	2,460	ELXV250E□□222MK40S	
	330	8 × 12	0.20	0.50	415	ELXV100E□□331MH12D	2,200	18 × 20	0.036	0.090	1,940	ELXV250E□□222MM20S	
	390	10 × 12.5	0.12	0.30	635	ELXV100E□□391MJC5S	2,700	16 × 30	0.025	0.063	2,510	ELXV250E□□272ML30S	
	470	8 × 15	0.16	0.40	495	ELXV100E□□471MH15D	2,700	18 × 25	0.027	0.068	2,350	ELXV250E□□272MM25S	
	680	8 × 20	0.11	0.28	640	ELXV100E□□681MH20D	3,300	16 × 35	0.022	0.055	2,770	ELXV250E□□332ML35S	
	680	10 × 16	0.084	0.21	825	ELXV100E□□681MJ16S	3,300	18 × 30	0.024	0.060	2,720	ELXV250E□□332MM30S	
	1,000	10 × 20	0.062	0.16	1,060	ELXV100E□□102MJ20S	3,900	16 × 40	0.018	0.045	3,110	ELXV250E□□392ML40S	
	1,200	10 × 25	0.052	0.13	1,260	ELXV100E□□122MJ25S	3,900	18 × 35	0.021	0.053	3,050	ELXV250E□□392MM35S	
	1,500	10 × 30	0.044	0.11	1,450	ELXV100E□□152MJ30S	4,700	18 × 40	0.017	0.043	3,300	ELXV250E□□472MM40S	
	1,800	12.5 × 20	0.046	0.12	1,360	ELXV100E□□182MK20S	27	5 × 11.5	0.72	1.8	165	ELXV350E□□270MEB5D	
	2,200	12.5 × 25	0.034	0.085	1,700	ELXV100E□□222MK25S	56	6.3 × 11.5	0.38	0.95	255	ELXV350E□□560MFB5D	
	2,700	12.5 × 30	0.030	0.075	1,980	ELXV100E□□272MK30S	82	6.3 × 15	0.27	0.68	330	ELXV350E□□820MF15D	
	3,300	12.5 × 35	0.027	0.068	2,230	ELXV100E□□332MK35S	120	8 × 12	0.20	0.50	415	ELXV350E□□121MH12D	
	3,300	16 × 20	0.038	0.095	1,770	ELXV100E□□332ML20S	120	10 × 12.5	0.12	0.30	635	ELXV350E□□121MJC5S	
	3,900	12.5 × 40	0.024	0.060	2,460	ELXV100E□□392MK40S	180	8 × 15	0.16	0.40	495	ELXV350E□□181MH15D	
	3,900	16 × 25	0.028	0.070	2,190	ELXV100E□□392ML25S	220	8 × 20	0.11	0.28	640	ELXV350E□□181MH20D	
	3,900	18 × 20	0.036	0.090	1,940	ELXV100E□□392MM20S	220	10 × 16	0.084	0.21	825	ELXV350E□□221MJ16S	
	4,700	18 × 25	0.027	0.068	2,350	ELXV100E□□472MM25S	330	10 × 20	0.062	0.16	1,060	ELXV350E□□331MJ20S	
	5,600	16 × 30	0.025	0.063	2,510	ELXV100E□□562ML30S	390	10 × 25	0.052	0.13	1,260	ELXV350E□□391MJ25S	
	6,800	16 × 35	0.022	0.055	2,770	ELXV100E□□682ML35S	560	10 × 30	0.044	0.11	1,450	ELXV350E□□392ML30S	
	6,800	18 × 30	0.024	0.060	2,720	ELXV100E□□682MM30S	560	12.5 × 20	0.046	0.12	1,360	ELXV350E□□561MK20S	
	8,200	16 × 40	0.018	0.045	3,110	ELXV100E□□822ML40S	680	12.5 × 25	0.034	0.085	1,700	ELXV350E□□681MK25S	
	8,200	18 × 35	0.021	0.053	3,050	ELXV100E□□822MM35S	1,000	12.5 × 30	0.030	0.075	1,980	ELXV350E□□102MK30S	
	10,000	18 × 40	0.017	0.043	3,300	ELXV100E□□103MM40S	1,000	16 × 20	0.038	0.095	1,770	ELXV350E□□102ML20S	
	56	5 × 11.5	0.72	1.8	165	ELXV160E□□560MEB5D	1,200	12.5 × 35	0.027	0.068	2,230	ELXV350E□□122MK35S	
	120	6.3 × 11.5	0.38	0.95	255	ELXV160E□□121MFB5D	1,200	16 × 25	0.028	0.070	2,190	ELXV350E□□122ML25S	
	180	6.3 × 15	0.27	0.68	330	ELXV160E□□181MF15D	1,500	12.5 × 40	0.024	0.060	2,460	ELXV350E□□152MK40S	
	270	8 × 12	0.20	0.50	415	ELXV160E□□271MH12D	1,500	18 × 20	0.036	0.090	1,940	ELXV350E□□152MM20S	
	270	10 × 12.5	0.12	0.30	635	ELXV160E□□271MJC5S	1,800	16 × 30	0.025	0.063	2,510	ELXV350E□□182ML30S	
	330	8 × 15	0.16	0.40	495	ELXV160E□□331MH15D	1,800	18 × 25	0.027	0.068	2,350	ELXV350E□□182MM25S	
	470	8 × 20	0.11	0.28	640	ELXV160E□□471MH20D	2,200	16 × 35	0.022	0.055	2,770	ELXV350E□□222ML35S	
	470	10 × 16	0.084	0.21	825	ELXV160E□□471MJ16S	2,200	18 × 30	0.024	0.060	2,720	ELXV350E□□222MM30S	
	680	10 × 20	0.062	0.16	1,060	ELXV160E□□681MJ20S	2,700	16 × 40	0.018	0.045	3,110	ELXV350E□□272ML40S	
	820	10 × 25	0.052	0.13	1,260	ELXV160E□□821MJ25S	2,700	18 × 35	0.021	0.053	3,050	ELXV350E□□272MM35S	
	1,200	10 × 30	0.044	0.11	1,450	ELXV160E□□122MJ30S	3,300	18 × 40	0.017	0.043	3,300	ELXV350E□□332MM40S	
	1,200	12.5 × 20	0.046	0.12	1,360	ELXV160E□□122MK20S	18	5 × 11.5	1.1	3.3	165	ELXV500E□□180MEB5D	
	1,500	12.5 × 25	0.034	0.085	1,700	ELXV160E□□152MK25S	39	6.3 × 11.5	0.56	1.6	255	ELXV500E□□390MFB5D	
	2,200	12.5 × 30	0.030	0.075	1,980	ELXV160E□□222MK30S	56	6.3 × 15	0.41	1.2	310	ELXV500E□□560MF15D	
	2,200	16 × 20	0.038	0.095	1,770	ELXV160E□□222ML20S	68	8 × 12	0.29	0.84	415	ELXV500E□□680MH12D	

□ : Enter the appropriate lead forming or taping code.

◆STANDARD RATINGS

WV (Vdc)	Cap (μF)	Case size φD×L(mm)	Impedance (Ωmax/100kHz)		Rated ripple current (mA _{rms} /105°C, 100kHz)	Part No.	WV (Vdc)	Cap (μF)	Case size φD×L(mm)	Impedance (Ωmax/100kHz)		Rated ripple current (mA _{rms} /105°C, 100kHz)	Part No.
			20°C	-10°C						20°C	-10°C		
50	82	8 × 15	0.24	0.72	505	ELXV500E□□820MH15D	80	27	6.3 × 15	0.62	1.7	220	ELXV800E□□270MF15D
	82	10 × 12.5	0.16	0.40	530	ELXV500E□□820MJC5S		33	8 × 12	0.53	1.5	275	ELXV800E□□330MH12D
	120	8 × 20	0.18	0.52	610	ELXV500E□□121MH20D		39	10 × 12.5	0.47	1.3	380	ELXV800E□□390MJC5S
	120	10 × 16	0.12	0.30	755	ELXV500E□□121MJ16S		47	8 × 15	0.35	0.97	360	ELXV800E□□470MH15D
	180	10 × 20	0.088	0.22	945	ELXV500E□□181MJ20S		56	8 × 20	0.27	0.74	490	ELXV800E□□560MH20D
	220	10 × 25	0.068	0.17	1,150	ELXV500E□□221MJ25S		56	10 × 16	0.33	0.90	500	ELXV800E□□560MJ16S
	330	10 × 30	0.059	0.15	1,260	ELXV500E□□331MJ30S		82	10 × 20	0.26	0.70	620	ELXV800E□□820MJ20S
	330	12.5 × 20	0.059	0.15	1,190	ELXV500E□□331MK20S		100	10 × 25	0.19	0.52	795	ELXV800E□□101MJ25S
	470	12.5 × 25	0.045	0.11	1,500	ELXV500E□□471MK25S		150	10 × 30	0.15	0.41	955	ELXV800E□□151MJ30S
	560	12.5 × 30	0.039	0.098	1,720	ELXV500E□□561MK30S		150	12.5 × 20	0.15	0.41	890	ELXV800E□□151MK20S
	680	12.5 × 35	0.033	0.083	1,900	ELXV500E□□681MK35S		180	12.5 × 25	0.11	0.30	1,040	ELXV800E□□181MK25S
	680	16 × 20	0.043	0.11	1,500	ELXV500E□□681ML20S		270	12.5 × 30	0.094	0.26	1,270	ELXV800E□□271MK30S
	820	12.5 × 40	0.029	0.073	2,120	ELXV500E□□821MK40S		270	16 × 20	0.11	0.30	1,240	ELXV800E□□271ML20S
	820	16 × 25	0.033	0.083	1,880	ELXV500E□□821ML25S		330	12.5 × 35	0.087	0.24	1,450	ELXV800E□□331MK35S
	820	18 × 20	0.039	0.098	1,660	ELXV500E□□821MM20S		330	16 × 25	0.081	0.22	1,440	ELXV800E□□331ML25S
	1,000	16 × 30	0.029	0.073	2,150	ELXV500E□□102ML30S		390	12.5 × 40	0.060	0.17	1,610	ELXV800E□□391MK40S
	1,000	18 × 25	0.030	0.075	2,020	ELXV500E□□102MM25S		390	18 × 20	0.085	0.23	1,450	ELXV800E□□391MM20S
	1,200	16 × 35	0.025	0.063	2,320	ELXV500E□□122ML35S		470	16 × 30	0.058	0.16	1,790	ELXV800E□□471ML30S
	1,500	16 × 40	0.021	0.053	2,650	ELXV500E□□152ML40S		470	18 × 25	0.070	0.19	1,650	ELXV800E□□471MM25S
	1,500	18 × 30	0.026	0.065	2,340	ELXV500E□□152MM30S		560	16 × 35	0.052	0.14	2,000	ELXV800E□□561ML35S
1,800	18 × 35	0.023	0.058	2,620	ELXV500E□□182MM35S	680	16 × 40	0.041	0.11	2,200	ELXV800E□□681ML40S		
2,200	18 × 40	0.020	0.050	2,790	ELXV500E□□222MM40S	680	18 × 30	0.058	0.16	1,850	ELXV800E□□681MM30S		
63	12	5 × 11.5	1.9	4.8	100	ELXV630E□□120MEB5D	1,000	18 × 35	0.052	0.14	1,990	ELXV800E□□821MM35S	
	27	6.3 × 11.5	1.1	2.8	160	ELXV630E□□270MFB5D	1,000	18 × 40	0.041	0.11	2,370	ELXV800E□□102MM40S	
	39	6.3 × 15	0.62	1.6	230	ELXV630E□□390MF15D	100	5.6	5 × 11.5	1.9	5.1	100	ELXV101E□□5R6MEB5D
	47	8 × 12	0.49	1.3	275	ELXV630E□□470MH12D		12	6.3 × 11.5	1.1	3.0	150	ELXV101E□□120MFB5D
	56	10 × 12.5	0.27	0.68	420	ELXV630E□□560MJC5S		18	6.3 × 15	0.62	1.7	220	ELXV101E□□180MF15D
	68	8 × 15	0.34	0.85	360	ELXV630E□□680MH15D		22	8 × 12	0.53	1.5	275	ELXV101E□□220MH12D
	68	10 × 16	0.21	0.53	523	ELXV630E□□680MJ16S		27	10 × 12.5	0.47	1.3	380	ELXV101E□□270MJC5S
	82	8 × 20	0.21	0.53	500	ELXV630E□□820MH20D		33	8 × 15	0.35	0.97	360	ELXV101E□□330MH15D
	120	10 × 20	0.16	0.40	650	ELXV630E□□121MJ20S		33	10 × 16	0.33	0.90	500	ELXV101E□□330MJ16S
	150	10 × 25	0.13	0.33	780	ELXV630E□□151MJ25S		39	8 × 20	0.27	0.74	490	ELXV101E□□390MH20D
	180	10 × 30	0.10	0.25	960	ELXV630E□□181MJ30S		56	10 × 20	0.26	0.70	620	ELXV101E□□560MJ20S
	220	12.5 × 20	0.11	0.28	870	ELXV630E□□221MK20S		68	10 × 25	0.19	0.52	795	ELXV101E□□680MJ25S
	270	12.5 × 25	0.074	0.19	1,150	ELXV630E□□271MK25S		100	10 × 30	0.15	0.41	955	ELXV101E□□101MJ30S
	390	12.5 × 30	0.068	0.17	1,280	ELXV630E□□391MK30S		100	12.5 × 20	0.15	0.41	890	ELXV101E□□101MK20S
	390	16 × 20	0.085	0.22	1,100	ELXV630E□□391ML20S		120	12.5 × 25	0.11	0.30	1,040	ELXV101E□□121MK25S
	470	12.5 × 35	0.063	0.16	1,390	ELXV630E□□471MK35S		180	12.5 × 30	0.094	0.26	1,270	ELXV101E□□181MK30S
	470	16 × 25	0.055	0.14	1,480	ELXV630E□□471ML25S		180	16 × 20	0.11	0.30	1,240	ELXV101E□□181ML20S
	560	12.5 × 40	0.051	0.13	1,530	ELXV630E□□561MK40S		220	12.5 × 35	0.087	0.24	1,450	ELXV101E□□221MK35S
	560	18 × 20	0.085	0.22	1,170	ELXV630E□□561MM20S		220	16 × 25	0.081	0.22	1,440	ELXV101E□□221ML25S
	680	16 × 30	0.046	0.12	1,720	ELXV630E□□681ML30S		270	12.5 × 40	0.060	0.17	1,610	ELXV101E□□271MK40S
680	18 × 25	0.055	0.14	1,520	ELXV630E□□681MM25S	270		18 × 20	0.085	0.23	1,450	ELXV101E□□271MM20S	
820	16 × 35	0.040	0.10	1,910	ELXV630E□□821ML35S	330		16 × 30	0.058	0.16	1,790	ELXV101E□□331ML30S	
820	18 × 30	0.046	0.12	1,770	ELXV630E□□821MM30S	330	18 × 25	0.070	0.19	1,650	ELXV101E□□331MM25S		
1,000	16 × 40	0.036	0.09	2,070	ELXV630E□□102ML40S	390	16 × 35	0.052	0.14	2,000	ELXV101E□□391ML35S		
1,000	18 × 35	0.040	0.10	1,970	ELXV630E□□102MM35S	390	18 × 30	0.058	0.16	1,850	ELXV101E□□391MM30S		
1,200	18 × 40	0.036	0.09	2,130	ELXV630E□□122MM40S	470	16 × 40	0.041	0.11	2,200	ELXV101E□□471ML40S		
80	8.2	5 × 11.5	1.9	5.1	100	ELXV800E□□8R2MEB5D	560	18 × 35	0.052	0.14	1,990	ELXV101E□□561MM35S	
	18	6.3 × 11.5	1.1	3.0	150	ELXV800E□□180MFB5D	680	18 × 40	0.041	0.11	2,370	ELXV101E□□681MM40S	

□ : Enter the appropriate lead forming or taping code.

◆RATED RIPPLE CURRENT MULTIPLIERS

●Frequency Multipliers

Rated voltage (Vdc)	Case size φD (mm)	Frequency (Hz)				Rated voltage (Vdc)	Case size φD (mm)	Frequency (Hz)			
		120	1k	10k	100k			120	1k	10k	100k
6.3 & 10	5 to 8	0.65	0.83	0.95	1.00	35 & 50	5 to 8	0.40	0.66	0.85	1.00
	10 & 12.5	0.70	0.85	0.96	1.00		10 & 12.5	0.50	0.73	0.89	1.00
	16 & 18	0.85	0.92	0.97	1.00		16 & 18	0.60	0.81	0.94	1.00
16 & 25	5 to 8	0.55	0.76	0.91	1.00	63 to 100	5 to 8	0.20	0.55	0.80	1.00
	10 & 12.5	0.65	0.83	0.93	1.00		10 & 12.5	0.35	0.65	0.85	1.00
	16 & 18	0.70	0.87	0.96	1.00		16 & 18	0.50	0.75	0.90	1.00

The endurance of capacitors is reduced with internal heating produced by ripple current at the rate of halving the lifetime with every 5°C rise.

When long life performance is required in actual use, the rms ripple current has to be reduced.

KXJ Series

- Downsized and Longer life from current KXG series
- Endurance with ripple current : 10,000 to 12,000 hours at 105°C
- Rated voltage range : 160 to 450V, Capacitance range : 6.8 to 680μF
- For electronic ballast circuits and other long life applications
- Non solvent resistant type
- RoHS Compliant

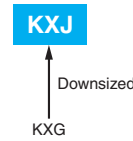

◆ SPECIFICATIONS

Items	Characteristics			
Category	- 40 to +105°C (160 to 400V _{dc}) -25 to +105°C (420, 450V _{dc})			
Temperature Range				
Rated Voltage Range	160 to 450V _{dc}			
Capacitance Tolerance	±20% (M) (at 20°C, 120Hz)			
Leakage Current		After 1 minute	After 5 minutes	
	CV ≤ 1000	I = 0.1CV + 40	I = 0.03CV + 15	
	CV > 1000	I = 0.04CV + 100	I = 0.02CV + 25	
	Where, I : Max. leakage current (μA), C : Nominal capacitance (μF), V : Rated voltage (V) (at 20°C)			
Dissipation Factor (tanδ)	Rated voltage (V _{dc})	160 to 250V	350 to 450V	
	tanδ (Max.)	0.20	0.24	(at 20°C, 120Hz)
Low Temperature Characteristics (Max. Impedance Ratio)	Rated voltage (V _{dc})	160 to 250V	350, 400V	420, 450V
	Z(-25°C)/Z(+20°C)	3	5	6
	Z(-40°C)/Z(+20°C)	6	6	-
	(at 120Hz)			
Endurance	The following specifications shall be satisfied when the capacitors are restored to 20°C after subjected to DC voltage with the rated ripple current is applied (the peak voltage shall not exceed the rated voltage) for 12,000 hours (10,000 hours for 20L max.) at 105°C.			
	Capacitance change	≤ ±20% of the initial value		
	D.F. (tanδ)	≤ 200% of the initial specified value		
	Leakage current	≤ The initial specified value		
Shelf Life	The following specifications shall be satisfied when the capacitors are restored to 20°C after exposing them for 1,000 hours at 105°C without voltage applied. Before the measurement, the capacitor shall be preconditioned by applying voltage according to Item 4.1 of JIS C 5101-4.			
	Capacitance change	≤ ±20% of the initial value		
	D.F. (tanδ)	≤ 200% of the initial specified value		
	Leakage current	≤ 500% of the initial specified value		

◆ DIMENSIONS [mm]

- Terminal Code : E

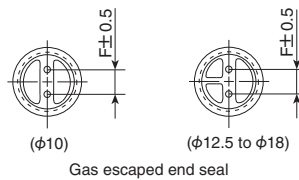
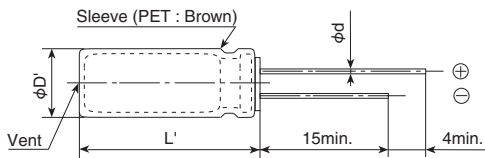

φD	10	12.5	14.5	16	18
φd	0.6	0.6	0.8	0.8	0.8
F	5.0	5.0	7.5	7.5	7.5
φD'	φD+0.5max.				
L'	L+1.5max.				

◆ PART NUMBERING SYSTEM

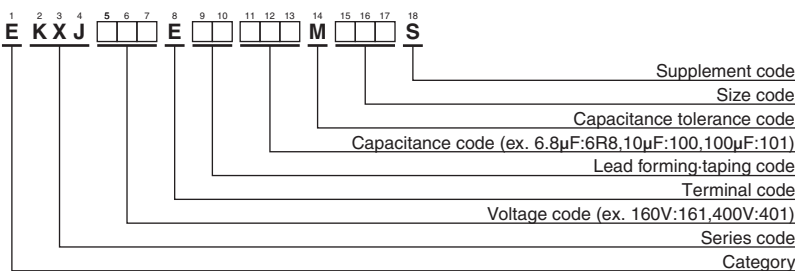

Please refer to "Product code guide (radial lead type)"

◆ RATED RIPPLE CURRENT MULTIPLIERS

- Frequency Multipliers

Frequency (Hz)	120	1k	10k	100k
Less than 100μF	1.00	1.75	2.25	2.50
100μF or more	1.00	1.67	2.05	2.25

The endurance of capacitors is reduced with internal heating produced by ripple current at the rate of halving the lifetime with every 5°C rise. When long life performance is required in actual use, the rms ripple current has to be reduced.

◆STANDARD RATINGS

WV (Vdc)	Cap (μF)	Case size ϕD×L(mm)	tanδ	Rated ripple current (mA rms/105°C, 120Hz)	Part No.	WV (Vdc)	Cap (μF)	Case size ϕD×L(mm)	tanδ	Rated ripple current (mA rms/105°C, 120Hz)	Part No.
160	39	10×16	0.20	245	EKXJ161E□□390MJ16S	220	27	10×16	0.20	200	EKXJ221E□□270MJ16S
	56	10×20	0.20	315	EKXJ161E□□560MJ20S		39	10×20	0.20	265	EKXJ221E□□390MJ20S
	82	10×25	0.20	415	EKXJ161E□□820MJ25S		56	10×25	0.20	345	EKXJ221E□□560MJ25S
	82	10×30	0.20	445	EKXJ161E□□820MJ30S		56	10×30	0.20	370	EKXJ221E□□560MJ30S
	100	12.5×20	0.20	575	EKXJ161E□□101MK20S		68	12.5×20	0.20	475	EKXJ221E□□680MK20S
	120	10×35	0.20	570	EKXJ161E□□121MJ35S		82	10×35	0.20	470	EKXJ221E□□820MJ35S
	120	14.5×20	0.20	675	EKXJ161E□□121MU20S		82	14.5×20	0.20	555	EKXJ221E□□820MU20S
	150	10×40	0.20	665	EKXJ161E□□151MJ40S		100	10×40	0.20	545	EKXJ221E□□101MJ40S
	150	10×45	0.20	695	EKXJ161E□□151MJ45S		100	10×45	0.20	565	EKXJ221E□□101MJ45S
	150	12.5×25	0.20	765	EKXJ161E□□151MK25S		100	12.5×25	0.20	625	EKXJ221E□□101MK25S
	180	10×50	0.20	785	EKXJ161E□□181MJ50S		120	10×50	0.20	645	EKXJ221E□□121MJ50S
	180	12.5×30	0.20	885	EKXJ161E□□181MK30S		120	12.5×30	0.20	725	EKXJ221E□□121MK30S
	180	14.5×25	0.20	890	EKXJ161E□□181MU25S		120	14.5×25	0.20	725	EKXJ221E□□121MU25S
	180	16×20	0.20	855	EKXJ161E□□181ML20S		120	16×20	0.20	695	EKXJ221E□□121ML20S
	220	12.5×35	0.20	1,040	EKXJ161E□□221MK35S		150	12.5×35	0.20	820	EKXJ221E□□151MK35S
	220	16×25	0.20	1,020	EKXJ161E□□221ML25S		150	16×25	0.20	845	EKXJ221E□□151ML25S
	220	18×20	0.20	990	EKXJ161E□□221MM20S		150	18×20	0.20	815	EKXJ221E□□151MM20S
	270	12.5×40	0.20	1,190	EKXJ161E□□271MK40S		180	12.5×40	0.20	975	EKXJ221E□□181MK40S
	270	12.5×45	0.20	1,230	EKXJ161E□□271MK45S		180	12.5×45	0.20	1,005	EKXJ221E□□181MK45S
	270	14.5×31.5	0.20	1,170	EKXJ161E□□271MUN3S		180	14.5×31.5	0.20	955	EKXJ221E□□181MUN3S
	270	14.5×35.5	0.20	1,210	EKXJ161E□□271MUP1S		220	12.5×50	0.20	1,145	EKXJ221E□□221MK50S
	330	12.5×50	0.20	1,400	EKXJ161E□□331MK50S		220	14.5×35.5	0.20	1,095	EKXJ221E□□221MUP1S
	330	14.5×40	0.20	1,385	EKXJ161E□□331MU40S		220	14.5×40	0.20	1,130	EKXJ221E□□221MU40S
	330	16×31.5	0.20	1,350	EKXJ161E□□331MLN3S		220	16×31.5	0.20	1,100	EKXJ221E□□221MLN3S
	330	18×25	0.20	1,290	EKXJ161E□□331MM25S		220	18×25	0.20	1,050	EKXJ221E□□221MM25S
	390	14.5×45	0.20	1,545	EKXJ161E□□391MU45S		270	14.5×45	0.20	1,285	EKXJ221E□□271MU45S
	390	16×35.5	0.20	1,500	EKXJ161E□□391MLP1S		270	14.5×50	0.20	1,315	EKXJ221E□□271MU50S
	470	14.5×50	0.20	1,735	EKXJ161E□□471MU50S		270	16×35.5	0.20	1,245	EKXJ221E□□271MLP1S
	470	16×40	0.20	1,700	EKXJ161E□□471ML40S		270	18×31.5	0.20	1,260	EKXJ221E□□271MMN3S
	470	16×45	0.20	1,730	EKXJ161E□□471ML45S		330	16×40	0.20	1,425	EKXJ221E□□331ML40S
	470	18×31.5	0.20	1,660	EKXJ161E□□471MMN3S		330	16×45	0.20	1,450	EKXJ221E□□331ML45S
	470	18×35.5	0.20	1,715	EKXJ161E□□471MMP1S		330	18×35.5	0.20	1,440	EKXJ221E□□331MMP1S
560	16×50	0.20	1,920	EKXJ161E□□561ML50S	390	16×50	0.20	1,600	EKXJ221E□□391ML50S		
560	18×40	0.20	1,905	EKXJ161E□□561MM40S	390	18×40	0.20	1,590	EKXJ221E□□391MM40S		
680	18×45	0.20	2,130	EKXJ161E□□681MM45S	390	18×45	0.20	1,620	EKXJ221E□□391MM45S		
680	18×50	0.20	2,145	EKXJ161E□□681MM50S	470	18×50	0.20	1,785	EKXJ221E□□471MM50S		
200	27	10×16	0.20	200	EKXJ201E□□270MJ16S	250	22	10×16	0.20	185	EKXJ251E□□220MJ16S
	47	10×20	0.20	290	EKXJ201E□□470MJ20S		33	10×20	0.20	240	EKXJ251E□□330MJ20S
	56	10×25	0.20	345	EKXJ201E□□560MJ25S		47	10×25	0.20	315	EKXJ251E□□470MJ25S
	68	10×30	0.20	405	EKXJ201E□□680MJ30S		47	10×30	0.20	340	EKXJ251E□□470MJ30S
	82	12.5×20	0.20	520	EKXJ201E□□820MK20S		56	12.5×20	0.20	430	EKXJ251E□□560MK20S
	100	10×35	0.20	520	EKXJ201E□□101MJ35S		68	10×35	0.20	430	EKXJ251E□□680MJ35S
	100	12.5×25	0.20	625	EKXJ201E□□101MK25S		68	14.5×20	0.20	505	EKXJ251E□□680MU20S
	100	14.5×20	0.20	615	EKXJ201E□□101MU20S		82	10×40	0.20	495	EKXJ251E□□820MJ40S
	120	10×40	0.20	595	EKXJ201E□□121MJ40S		82	10×45	0.20	515	EKXJ251E□□820MJ45S
	120	10×45	0.20	620	EKXJ201E□□121MJ45S		82	12.5×25	0.20	565	EKXJ251E□□820MK25S
	120	12.5×30	0.20	725	EKXJ201E□□121MK30S		100	10×50	0.20	585	EKXJ251E□□101MJ50S
	120	16×20	0.20	695	EKXJ201E□□121ML20S		100	12.5×30	0.20	660	EKXJ251E□□101MK30S
	150	10×50	0.20	720	EKXJ201E□□151MJ50S		100	14.5×25	0.20	665	EKXJ251E□□101MU25S
	150	12.5×35	0.20	860	EKXJ201E□□151MK35S		100	16×20	0.20	635	EKXJ251E□□121ML20S
	150	14.5×25	0.20	810	EKXJ201E□□151MU25S		120	12.5×35	0.20	770	EKXJ251E□□121MK35S
	180	14.5×31.5	0.20	955	EKXJ201E□□181MUN3S		120	16×25	0.20	755	EKXJ251E□□121ML25S
	180	16×25	0.20	925	EKXJ201E□□181ML25S		120	18×20	0.20	730	EKXJ251E□□121MM20S
	180	18×20	0.20	895	EKXJ201E□□181MM20S		150	12.5×40	0.20	890	EKXJ251E□□151MK40S
	220	12.5×40	0.20	1,075	EKXJ201E□□221MK40S		150	12.5×45	0.20	920	EKXJ251E□□151MK45S
	220	12.5×45	0.20	1,110	EKXJ201E□□221MK45S		150	14.5×31.5	0.20	870	EKXJ251E□□151MUN3S
	220	14.5×35.5	0.20	1,095	EKXJ201E□□221MUP1S		180	12.5×50	0.20	1,035	EKXJ251E□□181MK50S
	220	18×25	0.20	1,050	EKXJ201E□□221MM25S		180	14.5×35.5	0.20	990	EKXJ251E□□181MUP1S
	270	12.5×50	0.20	1,265	EKXJ201E□□271MK50S		180	14.5×40	0.20	1,020	EKXJ251E□□181MU40S
	270	14.5×40	0.20	1,250	EKXJ201E□□271MU40S		180	16×31.5	0.20	995	EKXJ251E□□181MLN3S
	270	14.5×45	0.20	1,290	EKXJ201E□□271MU45S		180	18×25	0.20	950	EKXJ251E□□181MM25S
	270	16×31.5	0.20	1,220	EKXJ201E□□271MLN3S		220	14.5×45	0.20	1,160	EKXJ251E□□221MU45S
	270	16×35.5	0.20	1,250	EKXJ201E□□271MLP1S		220	14.5×50	0.20	1,185	EKXJ251E□□221MU50S
	330	14.5×50	0.20	1,450	EKXJ201E□□331MU50S		220	16×35.5	0.20	1,125	EKXJ251E□□221MUP1S
	330	16×40	0.20	1,425	EKXJ201E□□331ML40S		220	18×31.5	0.20	1,135	EKXJ251E□□221MMN3S
	330	18×31.5	0.20	1,395	EKXJ201E□□331MMN3S		270	16×40	0.20	1,285	EKXJ251E□□271ML40S
	390	16×45	0.20	1,575	EKXJ201E□□391ML45S		270	16×45	0.20	1,310	EKXJ251E□□271ML45S
	390	18×35.5	0.20	1,565	EKXJ201E□□391MMP1S		270	18×35.5	0.20	1,300	EKXJ251E□□271MMP1S
470	16×50	0.20	1,755	EKXJ201E□□471ML50S	330	16×50	0.20	1,475	EKXJ251E□□331ML50S		
470	18×40	0.20	1,745	EKXJ201E□□471MM40S	330	18×40	0.20	1,460	EKXJ251E□□331MM40S		
470	18×45	0.20	1,770	EKXJ201E□□471MM45S	330	18×45	0.20	1,485	EKXJ251E□□331MM45S		
560	18×50	0.20	1,945	EKXJ201E□□561MM50S	390	18×50	0.20	1,625	EKXJ251E□□391MM50S		

□□ : Enter the appropriate lead forming or taping code.



◆STANDARD RATINGS

WV (Vdc)	Cap (μF)	Case size φD×L(mm)	tanδ	Rated ripple current (mA rms/105°C, 120Hz)	Part No.	WV (Vdc)	Cap (μF)	Case size φD×L(mm)	tanδ	Rated ripple current (mA rms/105°C, 120Hz)	Part No.
350	12	10×16	0.24	135	EKXJ351E□□120MJ16S	420	6.8	10×16	0.24	105	EKXJ421E□□6R8MJ16S
	22	10×20	0.24	200	EKXJ351E□□220MJ20S		12	10×20	0.24	150	EKXJ421E□□120MJ20S
	27	10×25	0.24	240	EKXJ351E□□270MJ25S		15	10×25	0.24	185	EKXJ421E□□150MJ25S
	27	10×30	0.24	255	EKXJ351E□□270MJ30S		18	10×30	0.24	215	EKXJ421E□□180MJ30S
	33	12.5×20	0.24	330	EKXJ351E□□330MK20S		22	12.5×20	0.24	285	EKXJ421E□□220MK20S
	39	10×35	0.24	325	EKXJ351E□□390MJ35S		27	10×35	0.24	275	EKXJ421E□□270MJ35S
	47	10×40	0.24	375	EKXJ351E□□470MJ40S		27	10×40	0.24	290	EKXJ421E□□270MJ40S
	47	12.5×25	0.24	425	EKXJ351E□□470MK25S		27	12.5×25	0.24	340	EKXJ421E□□270MK25S
	47	14.5×20	0.24	420	EKXJ351E□□470MU20S		27	14.5×20	0.24	335	EKXJ421E□□270MU20S
	56	10×45	0.24	425	EKXJ351E□□560MJ45S		33	10×45	0.24	335	EKXJ421E□□330MJ45S
	56	12.5×30	0.24	495	EKXJ351E□□560MK30S		33	12.5×30	0.24	400	EKXJ421E□□330MK30S
	56	16×20	0.24	475	EKXJ351E□□560ML20S		33	16×20	0.24	385	EKXJ421E□□330ML20S
	68	10×50	0.24	485	EKXJ351E□□680MJ50S		39	10×50	0.24	375	EKXJ421E□□390MJ50S
	68	12.5×35	0.24	580	EKXJ351E□□680MK35S		39	14.5×25	0.24	435	EKXJ421E□□390MU25S
	68	14.5×25	0.24	545	EKXJ351E□□680MU25S		47	12.5×35	0.24	505	EKXJ421E□□470MK35S
	68	18×20	0.24	550	EKXJ351E□□680MM20S		47	16×25	0.24	500	EKXJ421E□□470ML25S
	82	12.5×40	0.24	655	EKXJ351E□□820MK40S		47	18×20	0.24	480	EKXJ421E□□470MM20S
	82	14.5×31.5	0.24	645	EKXJ351E□□820MUN3S		56	12.5×40	0.24	570	EKXJ421E□□560MK40S
	82	16×25	0.24	625	EKXJ351E□□820ML25S		56	12.5×45	0.24	590	EKXJ421E□□560MK45S
	100	12.5×45	0.24	750	EKXJ351E□□101MK45S		56	14.5×31.5	0.24	560	EKXJ421E□□560MUN3S
	100	12.5×50	0.24	770	EKXJ351E□□101MK50S		68	12.5×50	0.24	670	EKXJ421E□□680MK50S
	100	14.5×35.5	0.24	740	EKXJ351E□□101MUP1S		68	14.5×35.5	0.24	640	EKXJ421E□□680MUP1S
	100	16×31.5	0.24	740	EKXJ351E□□101MLN3S		68	14.5×40	0.24	660	EKXJ421E□□680MU40S
	100	18×25	0.24	710	EKXJ351E□□101MM25S		68	16×31.5	0.24	645	EKXJ421E□□680MLN3S
	120	14.5×40	0.24	835	EKXJ351E□□121MU40S		68	18×25	0.24	615	EKXJ421E□□680MM25S
	120	14.5×45	0.24	860	EKXJ351E□□121MU45S		82	14.5×45	0.24	750	EKXJ421E□□820MU45S
120	16×35.5	0.24	830	EKXJ351E□□121MLP1S	82	16×35.5	0.24	725	EKXJ421E□□820MLP1S		
150	14.5×50	0.24	980	EKXJ351E□□151MU50S	82	18×31.5	0.24	730	EKXJ421E□□820MMN3S		
150	16×40	0.24	960	EKXJ351E□□151ML40S	100	14.5×50	0.24	845	EKXJ421E□□101MU50S		
150	16×45	0.24	975	EKXJ351E□□151ML45S	100	16×40	0.24	825	EKXJ421E□□101ML40S		
150	18×31.5	0.24	940	EKXJ351E□□151MMN3S	100	16×45	0.24	840	EKXJ421E□□101ML45S		
180	16×50	0.24	1,090	EKXJ351E□□181ML50S	100	18×35.5	0.24	835	EKXJ421E□□101MMP1S		
180	18×35.5	0.24	1,065	EKXJ351E□□181MMP1S	120	16×50	0.24	935	EKXJ421E□□121ML50S		
180	18×40	0.24	1,080	EKXJ351E□□181MM40S	120	18×40	0.24	930	EKXJ421E□□121MM40S		
220	18×45	0.24	1,210	EKXJ351E□□221MM45S	120	18×45	0.24	945	EKXJ421E□□121MM45S		
220	18×50	0.24	1,220	EKXJ351E□□221MM50S	150	18×50	0.24	1,060	EKXJ421E□□151MM50S		
400	10	10×16	0.24	125	EKXJ401E□□100MJ16S	450	6.8	10×16	0.24	105	EKXJ451E□□6R8MJ16S
	18	10×20	0.24	180	EKXJ401E□□180MJ20S		12	10×20	0.24	150	EKXJ451E□□120MJ20S
	22	10×25	0.24	215	EKXJ401E□□220MJ25S		15	10×25	0.24	185	EKXJ451E□□150MJ25S
	27	10×30	0.24	255	EKXJ401E□□270MJ30S		18	10×30	0.24	215	EKXJ451E□□180MJ30S
	27	12.5×20	0.24	300	EKXJ401E□□270MK20S		18	12.5×20	0.24	255	EKXJ451E□□180MK20S
	33	10×35	0.24	300	EKXJ401E□□330MJ35S		22	10×35	0.24	250	EKXJ451E□□220MJ35S
	39	10×40	0.24	340	EKXJ401E□□390MJ40S		27	10×40	0.24	290	EKXJ451E□□270MJ40S
	39	10×45	0.24	355	EKXJ401E□□390MJ45S		27	10×45	0.24	305	EKXJ451E□□270MJ45S
	39	12.5×25	0.24	390	EKXJ401E□□390MK25S		27	12.5×25	0.24	340	EKXJ451E□□270MK25S
	39	14.5×20	0.24	385	EKXJ401E□□390MU20S		27	14.5×20	0.24	335	EKXJ451E□□270MU20S
	47	12.5×30	0.24	455	EKXJ401E□□470MK30S		33	12.5×30	0.24	400	EKXJ451E□□330MK30S
	47	16×20	0.24	435	EKXJ401E□□470ML20S		33	14.5×25	0.24	400	EKXJ451E□□330MU25S
	56	10×50	0.24	440	EKXJ401E□□560MJ50S		33	16×20	0.24	385	EKXJ451E□□330ML20S
	56	12.5×35	0.24	525	EKXJ401E□□560MK35S		39	10×50	0.24	375	EKXJ451E□□390MJ50S
	56	14.5×25	0.24	495	EKXJ401E□□560MU25S		39	12.5×35	0.24	460	EKXJ451E□□390MK35S
	56	18×20	0.24	500	EKXJ401E□□560MM20S		39	18×20	0.24	440	EKXJ451E□□390MM20S
	68	12.5×40	0.24	600	EKXJ401E□□680MK40S		47	12.5×40	0.24	525	EKXJ451E□□470MK40S
	68	14.5×31.5	0.24	585	EKXJ401E□□680MUN3S		47	14.5×31.5	0.24	515	EKXJ451E□□470MUN3S
	68	16×25	0.24	570	EKXJ401E□□680ML25S		47	16×25	0.24	500	EKXJ451E□□470ML25S
	82	12.5×45	0.24	680	EKXJ401E□□820MK45S		56	12.5×45	0.24	590	EKXJ451E□□560MK45S
	82	12.5×50	0.24	700	EKXJ401E□□820MK50S		56	14.5×35.5	0.24	580	EKXJ451E□□560MUP1S
	82	14.5×35.5	0.24	670	EKXJ401E□□820MUP1S		56	16×31.5	0.24	585	EKXJ451E□□560MLN3S
	82	16×31.5	0.24	670	EKXJ401E□□820MLN3S		56	18×25	0.24	560	EKXJ451E□□560MM25S
	82	18×25	0.24	640	EKXJ401E□□820MM25S		68	12.5×50	0.24	670	EKXJ451E□□680MK50S
	100	14.5×40	0.24	760	EKXJ401E□□101MU40S		68	14.5×40	0.24	660	EKXJ451E□□680MU40S
	100	14.5×45	0.24	785	EKXJ401E□□101MU45S		68	14.5×45	0.24	680	EKXJ451E□□680MU45S
100	16×35.5	0.24	760	EKXJ401E□□101MLP1S	68	16×35.5	0.24	660	EKXJ451E□□680MLP1S		
120	14.5×50	0.24	875	EKXJ401E□□121MU50S	82	14.5×50	0.24	765	EKXJ451E□□820MU50S		
120	16×40	0.24	860	EKXJ401E□□121ML40S	82	16×40	0.24	750	EKXJ451E□□820ML40S		
120	16×45	0.24	875	EKXJ401E□□121ML45S	82	16×45	0.24	760	EKXJ451E□□820ML45S		
120	18×31.5	0.24	840	EKXJ401E□□121MMN3S	82	18×31.5	0.24	730	EKXJ451E□□820MMN3S		
120	18×35.5	0.24	870	EKXJ401E□□121MMP1S	100	16×50	0.24	855	EKXJ451E□□101ML50S		
150	16×50	0.24	995	EKXJ401E□□151ML50S	100	18×35.5	0.24	835	EKXJ451E□□101MMP1S		
150	18×40	0.24	985	EKXJ401E□□151MM40S	120	18×40	0.24	930	EKXJ451E□□121MM40S		
180	18×45	0.24	1,095	EKXJ401E□□181MM45S	120	18×45	0.24	945	EKXJ451E□□121MM45S		
220	18×50	0.24	1,220	EKXJ401E□□221MM50S	150	18×50	0.24	1,060	EKXJ451E□□151MM50S		

□□ : Enter the appropriate lead forming or taping code.

KXG Series

- For electronic ballast circuits and other long life applications
- Endurance with ripple current : 8,000 to 10,000 hours at 105°C
- Non solvent resistant type
- RoHS Compliant

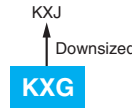

◆ SPECIFICATIONS

Items	Characteristics			
Category	—40 to +105°C (160 to 400V _{dc}) —25 to +105°C (450V _{dc})			
Temperature Range				
Rated Voltage Range	160 to 450V _{dc}			
Capacitance Tolerance	±20% (M) (at 20°C, 120Hz)			
Leakage Current		After 1 minute	After 5 minutes	
	CV ≤ 1,000	I = 0.1CV + 40	I = 0.03CV + 15	
	CV > 1,000	I = 0.04CV + 100	I = 0.02CV + 25	
	Where, I : Max. leakage current (μA), C : Nominal capacitance (μF), V : Rated voltage (V) (at 20°C)			
Dissipation Factor (tanδ)	Rated voltage (V _{dc})	160 to 250V	350 to 450V	
	tanδ (Max.)	0.20	0.24	(at 20°C, 120Hz)
Low Temperature Characteristics (Max. Impedance Ratio)	Rated voltage (V _{dc})	160 to 250V	350 & 400V	450V
	Z(-25°C)/Z(+20°C)	3	5	6
	Z(-40°C)/Z(+20°C)	6	6	—
	(at 120Hz)			
Endurance	The following specifications shall be satisfied when the capacitors are restored to 20°C after subjected to DC voltage with the rated ripple current is applied (the peak voltage shall not exceed the rated voltage) for 10,000 hours (8,000 hours for φ10) at 105°C.			
	Capacitance change	≤ ±20% of the initial value		
	D.F. (tanδ)	≤ 200% of the initial specified value		
	Leakage current	≤ The initial specified value		
Shelf Life	The following specifications shall be satisfied when the capacitors are restored to 20°C after exposing them for 1,000 hours at 105°C without voltage applied. Before the measurement, the capacitor shall be preconditioned by applying voltage according to Item 4.1 of JIS C 5101-4.			
	Capacitance change	≤ ±20% of the initial value		
	D.F. (tanδ)	≤ 200% of the initial specified value		
	Leakage current	≤ 500% of the initial specified value		

◆ DIMENSIONS [mm]

- Terminal Code : E

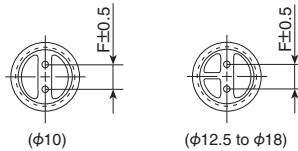
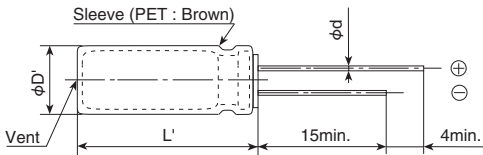

φD	10	12.5	16	18
φd	0.6	0.6	0.8	0.8
F	5.0	5.0	7.5	7.5
φD'	φD+0.5max.			
L'	L+1.5max.			

◆ PART NUMBERING SYSTEM

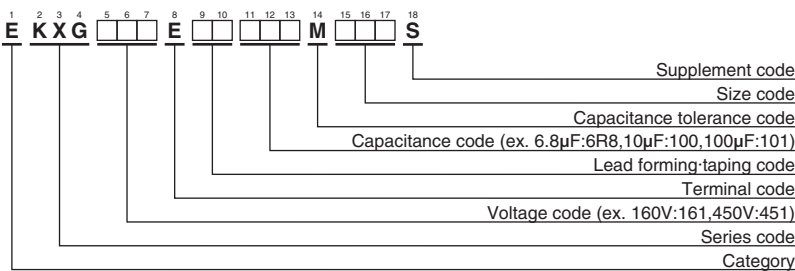

Please refer to "Product code guide (radial lead type)"

◆ RATED RIPPLE CURRENT MULTIPLIERS

- Frequency Multipliers

Capacitance (μF)	Frequency (Hz)			
	120	1k	10k	100k
6.8 to 82	1.00	1.75	2.25	2.50
100 to 330	1.00	1.67	2.05	2.25

The endurance of capacitors is reduced with internal heating produced by ripple current at the rate of halving the lifetime with every 5°C rise. When long life performance is required in actual use, the rms ripple current has to be reduced.



◆STANDARD RATINGS

VV (Vdc)	Cap (μF)	Case size φDXL(mm)	tanδ	Rated ripple current(mArms/105°C)		Part No.
				120Hz	100kHz	
160	10	10 × 16	0.20	125	315	EKXG161E□□100MJ16S
	22	10 × 20	0.20	200	500	EKXG161E□□220MJ20S
	33	10 × 20	0.20	250	625	EKXG161E□□330MJ20S
	47	10 × 20	0.20	300	750	EKXG161E□□470MJ20S
	68	12.5 × 20	0.20	470	1,175	EKXG161E□□680MK20S
	82	12.5 × 20	0.20	510	1,275	EKXG161E□□820MK20S
	100	12.5 × 25	0.20	620	1,395	EKXG161E□□101MK25S
	100	16 × 20	0.20	630	1,420	EKXG161E□□101ML20S
	150	16 × 20	0.20	770	1,735	EKXG161E□□151ML20S
	220	16 × 25	0.20	1,020	2,295	EKXG161E□□221ML25S
330	18 × 31.5	0.20	1,390	3,130	EKXG161E□□331MMN3S	
200	10	10 × 16	0.20	125	315	EKXG201E□□100MJ16S
	22	10 × 20	0.20	200	500	EKXG201E□□220MJ20S
	33	10 × 20	0.20	260	650	EKXG201E□□330MJ20S
	47	12.5 × 20	0.20	390	975	EKXG201E□□470MK20S
	68	12.5 × 20	0.20	470	1,175	EKXG201E□□680MK20S
	82	16 × 20	0.20	550	1,375	EKXG201E□□820ML20S
	100	16 × 20	0.20	630	1,420	EKXG201E□□101ML20S
	150	16 × 25	0.20	840	1,890	EKXG201E□□151ML25S
	220	18 × 25	0.20	1,050	2,365	EKXG201E□□221MM25S
	330	18 × 35.5	0.20	1,430	3,220	EKXG201E□□331MMP1S
250	10	10 × 20	0.20	140	350	EKXG251E□□100MJ20S
	22	10 × 20	0.20	200	500	EKXG251E□□220MJ20S
	33	12.5 × 20	0.20	320	800	EKXG251E□□330MK20S
	47	12.5 × 20	0.20	390	975	EKXG251E□□470MK20S
	68	16 × 20	0.20	520	1,300	EKXG251E□□680ML20S
	82	16 × 20	0.20	550	1,375	EKXG251E□□820ML20S
	100	16 × 25	0.20	680	1,530	EKXG251E□□101ML25S
	150	18 × 25	0.20	860	1,935	EKXG251E□□151MM25S
	220	18 × 31.5	0.20	1,130	2,545	EKXG251E□□221MMN3S
350	6.8	10 × 16	0.24	110	275	EKXG351E□□6R8MJ16S
	10	10 × 20	0.24	140	350	EKXG351E□□100MJ20S
	22	12.5 × 20	0.24	260	650	EKXG351E□□220MK20S
	33	16 × 20	0.24	360	900	EKXG351E□□330ML20S
	47	16 × 20	0.24	430	1,075	EKXG351E□□470ML20S
	68	16 × 25	0.24	560	1,400	EKXG351E□□680ML25S
	68	18 × 20	0.24	550	1,375	EKXG351E□□680MM20S
	82	18 × 25	0.24	610	1,525	EKXG351E□□820MM25S
	100	18 × 25	0.24	700	1,575	EKXG351E□□101MM25S
	120	18 × 31.5	0.24	830	1,865	EKXG351E□□121MMN3S
150	18 × 35.5	0.24	960	2,160	EKXG351E□□151MMP1S	
400	6.8	10 × 16	0.24	110	275	EKXG401E□□6R8MJ16S
	10	10 × 20	0.24	140	350	EKXG401E□□100MJ20S
	15	12.5 × 20	0.24	220	550	EKXG401E□□150MK20S
	22	12.5 × 20	0.24	260	650	EKXG401E□□220MK20S
	33	16 × 20	0.24	360	900	EKXG401E□□330ML20S
	47	16 × 25	0.24	470	1,175	EKXG401E□□470ML25S
	47	18 × 20	0.24	450	1,125	EKXG401E□□470MM20S
	68	18 × 25	0.24	585	1,465	EKXG401E□□680MM25S
	82	18 × 25	0.24	610	1,525	EKXG401E□□820MM25S
	100	18 × 31.5	0.24	765	1,720	EKXG401E□□101MMN3S
120	18 × 35.5	0.24	865	1,945	EKXG401E□□121MMP1S	
150	18 × 40	0.24	985	2,215	EKXG401E□□151MM40S	
450	6.8	10 × 20	0.24	110	275	EKXG451E□□6R8MJ20S
	10	12.5 × 20	0.24	180	450	EKXG451E□□100MK20S
	15	12.5 × 25	0.24	240	600	EKXG451E□□150MK25S
	22	16 × 20	0.24	290	725	EKXG451E□□220ML20S
	33	16 × 25	0.24	390	975	EKXG451E□□330ML25S
	33	18 × 20	0.24	380	950	EKXG451E□□330MM20S
	47	18 × 25	0.24	480	1,200	EKXG451E□□470MM25S
	68	18 × 31.5	0.24	630	1,575	EKXG451E□□680MMN3S
	82	18 × 35.5	0.24	715	1,785	EKXG451E□□820MMP1S
	100	18 × 40	0.24	800	1,800	EKXG451E□□101MM40S

□□ : Enter the appropriate lead forming or taping code.

New!

KHE Series

- Ideal for low profile power supply applications
- Downsize, high ripple design
- Rated voltage range : 400 to 450V_{dc}, Capacitance range : 27 to 120 μF
- Endurance with ripple current : 2,000 hours at 105°C
- Non solvent resistant type
- RoHS Compliant

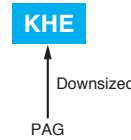

◆ SPECIFICATIONS

Items	Characteristics				
Category Temperature Range	-40 to +105°C (400V _{dc}) -25 to +105°C (420, 450V _{dc})				
Rated Voltage Range	400 to 450V _{dc}				
Capacitance Tolerance	±20% (M) (at 20°C, 120Hz)				
Leakage Current		After 1 minute	After 5 minutes		
	CV ≤ 1,000	I = 0.1CV + 40	I = 0.03CV + 15		
	CV > 1,000	I = 0.04CV + 100	I = 0.02CV + 25		
	Where, I : Max. leakage current (μA), C : Nominal capacitance (μF), V : Rated voltage (V) (at 20°C)				
Dissipation Factor (tanδ)	Rated voltage (V _{dc})	400V	420V	450V	(at 20°C, 120Hz)
	tanδ (Max.)	0.15	0.20	0.20	
Low Temperature Characteristics (Max. Impedance Ratio)	Rated voltage (V _{dc})	400V	420V	450V	(at 120Hz)
	Z(-25°C)/Z(+20°C)	5	6	6	
	Z(-40°C)/Z(+20°C)	6	—	—	
Endurance	The following specifications shall be satisfied when the capacitors are restored to 20°C after subjected to DC voltage with the rated ripple current is applied (the peak voltage shall not exceed the rated voltage) for 2,000 hours at 105°C.				
	Capacitance change	≤ ±20% of the initial value			
	D.F. (tanδ)	≤ 200% of the initial specified value			
	Leakage current	≤ The initial specified value			
Shelf Life	The following specifications shall be satisfied when the capacitors are restored to 20°C after exposing them for 1,000 hours at 105°C without voltage applied. Before the measurement, the capacitor shall be preconditioned by applying voltage according to Item 4.1 of JIS C 5101-4.				
	Capacitance change	≤ ±20% of the initial value			
	D.F. (tanδ)	≤ 200% of the initial specified value			
	Leakage current	≤ 500% of the initial specified value			

◆ DIMENSIONS [mm]

● Terminal Code : E

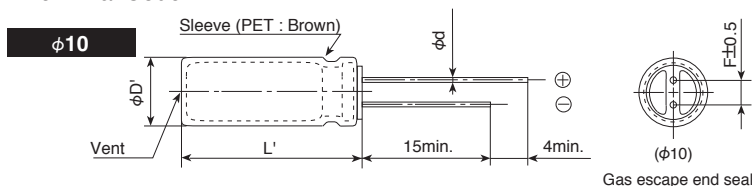

φD	10	12.5	14.5	16	18
φd	0.6	0.6	0.8	0.8	0.8
F	5.0	5.0	7.5	7.5	7.5
φD'	φD+0.5 max.				
L'	L+2.0 max.				

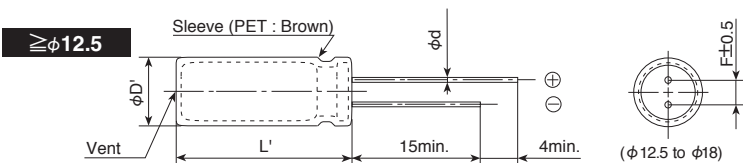

◆ PART NUMBERING SYSTEM

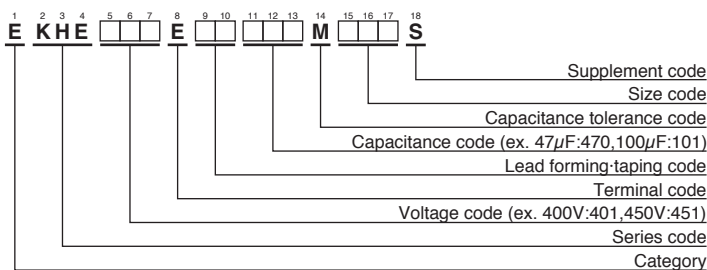

Please refer to "Product code guide (radial lead type)"

◆STANDARD RATINGS

WV (Vdc)	Cap (μF)	Case size φD×L(mm)	tanδ	Rated ripple current (mA _{rms} /105°C, 120Hz)	Part No.	WV (Vdc)	Cap (μF)	Case size φD×L(mm)	tanδ	Rated ripple current (mA _{rms} /105°C, 120Hz)	Part No.
400	33	10×30	0.15	335	EKHE401E□□330MJ30S	450	27	10×30	0.20	305	EKHE451E□□270MJ30S
	39	10×35	0.15	385	EKHE401E□□390MJ35S		33	10×35	0.20	355	EKHE451E□□330MJ35S
	47	10×40	0.15	445	EKHE401E□□470MJ40S		39	10×40	0.20	405	EKHE451E□□390MJ40S
	56	10×45	0.15	505	EKHE401E□□560MJ45S		47	10×45	0.20	460	EKHE451E□□470MJ45S
	56	12.5×30	0.15	480	EKHE401E□□560MK30S		47	12.5×30	0.20	440	EKHE451E□□470MK30S
	68	12.5×35	0.15	560	EKHE401E□□680MK35S		56	12.5×35	0.20	505	EKHE451E□□560MK35S
	82	12.5×40	0.15	640	EKHE401E□□820MK40S		68	12.5×40	0.20	580	EKHE451E□□680MK40S
	82	14.5×31.5	0.15	625	EKHE401E□□820MUN3S		68	14.5×31.5	0.20	570	EKHE451E□□680MUN3S
	100	12.5×45	0.15	730	EKHE401E□□101MK45S		82	12.5×45	0.20	660	EKHE451E□□820MK45S
	100	14.5×35	0.15	715	EKHE401E□□101MU35S		82	14.5×35	0.20	650	EKHE451E□□820MU35S
	100	16×31.5	0.15	720	EKHE401E□□101MLN3S		82	16×31.5	0.20	655	EKHE451E□□820MLN3S
	120	14.5×40	0.15	810	EKHE401E□□121MU40S		100	14.5×40	0.20	740	EKHE451E□□101MU40S
120	16×35	0.15	810	EKHE401E□□121ML35S	100	16×35	0.20	740	EKHE451E□□101ML35S		
120	18×31.5	0.15	815	EKHE401E□□121MMN3S	120	18×31.5	0.20	815	EKHE451E□□121MMN3S		
420	33	10×30	0.20	335	EKHE421E□□330MJ30S						
	39	10×35	0.20	385	EKHE421E□□390MJ35S						
	47	10×40	0.20	445	EKHE421E□□470MJ40S						
	56	10×50	0.20	520	EKHE421E□□560MJ50S						
	56	12.5×30	0.20	480	EKHE421E□□560MK30S						
	68	12.5×35	0.20	560	EKHE421E□□680MK35S						
	82	12.5×40	0.20	640	EKHE421E□□820MK40S						
	82	14.5×31.5	0.20	625	EKHE421E□□820MUN3S						
	100	12.5×50	0.20	750	EKHE421E□□101MK50S						
	100	14.5×40	0.20	740	EKHE421E□□101MU40S						
	100	16×31.5	0.20	720	EKHE421E□□101MLN3S						
	120	14.5×45	0.20	835	EKHE421E□□121MU45S						
120	16×35	0.20	810	EKHE421E□□121ML35S							
120	18×31.5	0.20	815	EKHE421E□□121MMN3S							

□□ : Enter the appropriate lead forming or taping code.

◆RATED RIPPLE CURRENT MULTIPLIERS

●Frequency Multipliers

Capacitance (μF)	Frequency (Hz)			
	120	1k	10k	100k
27 to 82	1.00	1.50	1.75	1.80
100 to 120	1.00	1.30	1.40	1.50

The endurance of capacitors is reduced with internal heating produced by ripple current at the rate of halving the lifetime with every 5°C rise. When long life performance is required in actual use, the rms ripple current has to be reduced.

PAG Series

- Downsize, high ripple design (φ10 to 18)
- Rated voltage range : 200 to 450V_{dc}, Capacitance range : 18 to 560μF
- Endurance with ripple current : 2,000 hours at 105°C
- Ideal for low profile power supply applications
- Non solvent resistant type
- RoHS Compliant

PAG
↓
Downsized
Higher ripple
KMG



◆SPECIFICATIONS

Items	Characteristics				
Category	—40 to +105°C (200, 400V _{dc}) —25 to+105°C (420, 450V _{dc})				
Temperature Range					
Rated Voltage Range	200 to 450V _{dc}				
Capacitance Tolerance	±20% (M) (at 20°C, 120Hz)				
Leakage Current		After 1 minute		After 5 minutes	
	CV ≤ 1,000	I = 0.1CV + 40		I = 0.03CV + 15	
	CV > 1,000	I = 0.04CV + 100		I = 0.02CV + 25	
	Where, I : Max. leakage current (μA), C : Nominal capacitance (μF), V : Rated voltage (V) (at 20°C)				
Dissipation Factor (tanδ)	Rated voltage (V _{dc})	200V	400V	420V	450V
	tanδ (Max.)	0.12	0.15	0.20	0.20
	(at 20°C, 120Hz)				
Low Temperature Characteristics (Max. Impedance Ratio)	Rated voltage (V _{dc})	200V	400V	420V	450V
	Z(-25°C)/Z(+20°C)	3	5	6	6
	Z(-40°C)/Z(+20°C)	6	6	—	—
	(at 120Hz)				
Endurance	The following specifications shall be satisfied when the capacitors are restored to 20°C after subjected to DC voltage with the rated ripple current is applied (the peak voltage shall not exceed the rated voltage) for 2,000 hours at 105°C.				
	Capacitance change	≤ ±20% of the initial value			
	D.F. (tanδ)	≤ 200% of the initial specified value			
	Leakage current	≤ The initial specified value			
Shelf Life	The following specifications shall be satisfied when the capacitors are restored to 20°C after exposing them for 1,000 hours at 105°C without voltage applied. Before the measurement, the capacitor shall be preconditioned by applying voltage according to Item 4.1 of JIS C 5101-4.				
	Capacitance change	≤ ±20% of the initial value			
	D.F. (tanδ)	≤ 200% of the initial specified value			
	Leakage current	≤ 500% of the initial specified value			

◆DIMENSIONS [mm]

- Terminal Code : E

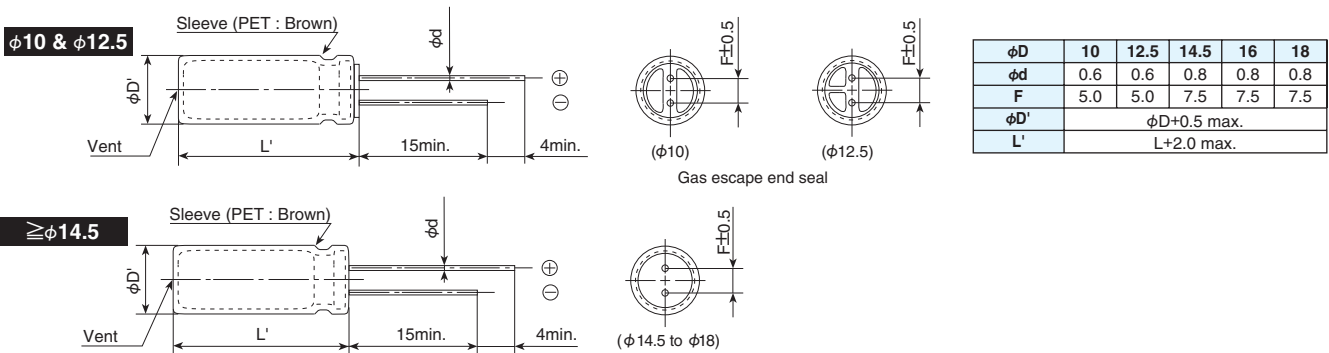

◆PART NUMBERING SYSTEM

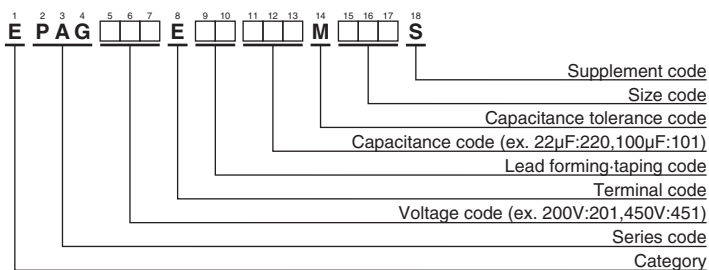

Please refer to "Product code guide (radial lead type)"

◆STANDARD RATINGS

WV (Vdc)	Cap (μF)	Case size φD×L(mm)	tanδ	Rated ripple current (mA _{rms} /105°C,120Hz)	Part No.	WV (Vdc)	Cap (μF)	Case size φD×L(mm)	tanδ	Rated ripple current (mA _{rms} /105°C,120Hz)	Part No.
200	82	10×30	0.12	440	EPAG201E□□820MJ30S	420	22	10×30	0.20	230	EPAG421E□□220MJ30S
	100	10×35	0.12	510	EPAG201E□□101MJ35S		27	10×35	0.20	270	EPAG421E□□270MJ35S
	120	10×40	0.12	590	EPAG201E□□121MJ40S		33	10×40	0.20	310	EPAG421E□□330MJ40S
	150	12.5×30	0.12	650	EPAG201E□□151MK30S		39	12.5×30	0.20	330	EPAG421E□□390MK30S
	180	12.5×35	0.12	750	EPAG201E□□181MK35S		47	12.5×35	0.20	390	EPAG421E□□470MK35S
	220	12.5×40	0.12	830	EPAG201E□□221MK40S		56	12.5×40	0.20	430	EPAG421E□□560MK40S
	220	14.5×30	0.12	830	EPAG201E□□221MU30S		56	14.5×30	0.20	430	EPAG421E□□560MU30S
	270	14.5×35	0.12	960	EPAG201E□□271MU35S		68	14.5×35	0.20	510	EPAG421E□□680MU35S
	270	16×30	0.12	960	EPAG201E□□271ML30S		68	16×30	0.20	510	EPAG421E□□680ML30S
	330	16×35	0.12	1,100	EPAG201E□□331ML35S		82	14.5×40	0.20	570	EPAG421E□□820MU40S
	330	18×30	0.12	1,100	EPAG201E□□331MM30S		82	16×35	0.20	570	EPAG421E□□820ML35S
	390	16×40	0.12	1,240	EPAG201E□□391ML40S		100	16×40	0.20	610	EPAG421E□□101ML40S
	390	18×35	0.12	1,240	EPAG201E□□391MM35S		100	18×30	0.20	610	EPAG421E□□101MM30S
	470	18×40	0.12	1,390	EPAG201E□□471MM40S		120	18×35	0.20	690	EPAG421E□□121MM35S
560	18×45	0.12	1,560	EPAG201E□□561MM45S	150	18×40	0.20	790	EPAG421E□□151MM40S		
400	27	10×30	0.15	260	EPAG401E□□270MJ30S	450	18	10×30	0.20	210	EPAG451E□□180MJ30S
	33	10×35	0.15	300	EPAG401E□□330MJ35S		22	10×35	0.20	240	EPAG451E□□220MJ35S
	39	10×40	0.15	340	EPAG401E□□390MJ40S		27	10×40	0.20	280	EPAG451E□□270MJ40S
	47	12.5×30	0.15	370	EPAG401E□□470MK30S		33	12.5×30	0.20	310	EPAG451E□□330MK30S
	56	12.5×35	0.15	420	EPAG401E□□560MK35S		39	12.5×35	0.20	350	EPAG451E□□390MK35S
	68	12.5×40	0.15	480	EPAG401E□□680MK40S		47	12.5×40	0.20	390	EPAG451E□□470MK40S
	68	14.5×30	0.15	480	EPAG401E□□680MU30S		47	14.5×30	0.20	390	EPAG451E□□470MU30S
	82	14.5×35	0.15	530	EPAG401E□□820MU35S		56	14.5×35	0.20	440	EPAG451E□□560MU35S
	100	14.5×40	0.15	580	EPAG401E□□101MU40S		56	16×30	0.20	440	EPAG451E□□560ML30S
	100	16×30	0.15	580	EPAG401E□□101ML30S		68	14.5×40	0.20	500	EPAG451E□□680MU40S
	120	16×35	0.15	670	EPAG401E□□121ML35S		68	16×35	0.20	500	EPAG451E□□680ML35S
	120	18×30	0.15	670	EPAG401E□□121MM30S		82	16×40	0.20	550	EPAG451E□□820ML40S
	150	16×40	0.15	770	EPAG401E□□151ML40S		82	18×30	0.20	550	EPAG451E□□820MM30S
	150	18×35	0.15	770	EPAG401E□□151MM35S		100	18×35	0.20	650	EPAG451E□□101MM35S
180	18×40	0.15	880	EPAG401E□□181MM40S	120	18×40	0.20	740	EPAG451E□□121MM40S		
220	18×45	0.15	1,000	EPAG401E□□221MM45S	150	18×45	0.20	810	EPAG451E□□151MM45S		

□□ : Enter the appropriate lead forming or taping code.

◆RATED RIPPLE CURRENT MULTIPLIERS
●Frequency Multipliers

Capacitance (μF)	Frequency (Hz)	120	1k	10k	100k
18 to 82		1.00	1.50	1.75	1.80
100 to 560		1.00	1.30	1.40	1.50

The endurance of capacitors is reduced with internal heating produced by ripple current at the rate of halving the lifetime with every 5°C rise. When long life performance is required in actual use, the rms ripple current has to be reduced.

KLJ Series

- Doesn't spark with DC over voltage
- Endurance with ripple current : 2,000 hours at 105°C
- Non solvent resistant type
- ESR value prescribed
- RoHS Compliant

KLJ

↓
Downsized

↑
KLG



◆ SPECIFICATIONS

Items	Characteristics		
Category	-25 to +105°C		
Temperature Range			
Rated Voltage Range	200 & 400V _{dc}		
Capacitance Tolerance	±20% (M) (at 20°C, 120Hz)		
Leakage Current	I=0.04CV+100 Where, I : Max. leakage current (μA), C : Nominal capacitance (μF), V : Rated voltage (V) (at 20°C after 1 minute)		
Dissipation Factor (tanδ)	Rated voltage (V _{dc})	200V	400V
	tanδ (Max.)	0.20	0.24
Low Temperature Characteristics (Max. Impedance Ratio)	Rated voltage (V _{dc})	200V	400V
	Z(-25°C)/Z(+20°C)	4	6
Endurance	The following specifications shall be satisfied when the capacitors are restored to 20°C after subjected to DC voltage with the rated ripple current is applied (the peak voltage shall not exceed the rated voltage) for 2,000 hours at 105°C.		
	Capacitance change	≤±20% of the initial value	
	D.F. (tanδ)	≤200% of the initial specified value	
	Leakage current	≤The initial specified value	
Shelf Life	The following specifications shall be satisfied when the capacitors are restored to 20°C after exposing them for 1,000 hours at 105°C without voltage applied. Before the measurement, the capacitor shall be preconditioned by applying voltage according to Item 4.1 of JIS C 5101-4.		
	Capacitance change	≤±20% of the initial value	
	D.F. (tanδ)	≤200% of the initial specified value	
	Leakage current	≤500% of the initial specified value	

◆ DIMENSIONS [mm]

- Terminal Code : E

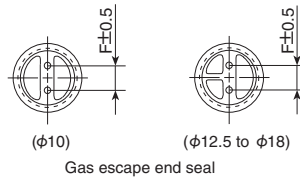
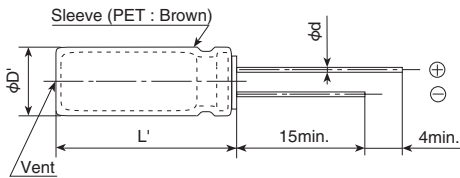

φD	10	12.5	16	18
φd	0.6	0.6	0.8	0.8
F	5.0	5.0	7.5	7.5
φD'	φD+0.5max.			
L'	L+1.5max.			

◆ PART NUMBERING SYSTEM

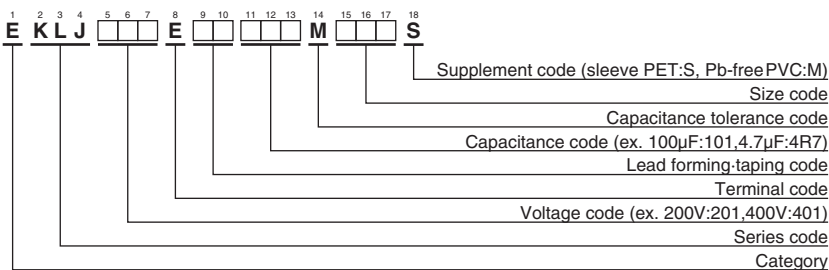

Please refer to "Product code guide (radial lead type)"

◆STANDARD RATINGS

WV (V _{dc})	Cap (μF)	Case size φD×L(mm)	tanδ	ESR (Ω _{max} /20°C, 100kHz)	Rated ripple current (mA _{rms} /105°C, 120Hz)	Part No.
200	33	10×20	0.20	1.8	165	EKLJ201E□□330MJ20S
	39	10×25	0.20	1.4	200	EKLJ201E□□390MJ25S
	56	12.5×20	0.20	1.0	265	EKLJ201E□□560MK20S
	82	12.5×25	0.20	0.72	350	EKLJ201E□□820MK25S
	100	16×20	0.20	0.63	390	EKLJ201E□□101ML20S
	120	16×25	0.20	0.44	465	EKLJ201E□□121ML25S
	150	18×20	0.20	0.31	505	EKLJ201E□□151MM20S
	180	16×31.5	0.20	0.36	615	EKLJ201E□□181MLN3S
	180	18×25	0.20	0.30	585	EKLJ201E□□181MM25S
	220	16×35.5	0.20	0.30	695	EKLJ201E□□221MLP1S
	220	18×31.5	0.20	0.28	700	EKLJ201E□□221MMN3S
270	18×35.5	0.20	0.24	805	EKLJ201E□□271MMP1S	
330	18×40	0.20	0.21	900	EKLJ201E□□331MM40S	
400	4.7	10×12.5	0.24	8.4	36	EKLJ401E□□4R7MJC5S
	10	10×16	0.24	5.7	64	EKLJ401E□□100MJ16S
	15	10×20	0.24	4.0	105	EKLJ401E□□150MJ20S
	18	10×25	0.24	3.2	110	EKLJ401E□□180MJ25S
	22	12.5×20	0.24	2.7	165	EKLJ401E□□220MK20S
	27	12.5×25	0.24	1.9	200	EKLJ401E□□270MK25S
	33	16×20	0.24	1.5	225	EKLJ401E□□330ML20S
	39	18×20	0.24	1.2	255	EKLJ401E□□390MM20S
	39	18×25	0.24	0.72	270	EKLJ401E□□390MM25S
	47	16×25	0.24	1.1	290	EKLJ401E□□470ML25S
	47	18×20	0.24	1.2	280	EKLJ401E□□470MM20S
	56	16×31.5	0.24	0.84	340	EKLJ401E□□560MLN3S
	68	16×35.5	0.24	0.72	385	EKLJ401E□□680MLP1S
	68	18×25	0.24	0.88	360	EKLJ401E□□680MM25S
	82	16×40	0.24	0.65	435	EKLJ401E□□820ML40S
	82	18×31.5	0.24	0.64	425	EKLJ401E□□820MMN3S
	100	18×35.5	0.24	0.54	490	EKLJ401E□□101MMP1S
120	18×40	0.24	0.49	540	EKLJ401E□□121MM40S	

□□ : Enter the appropriate lead forming or taping code.
 Sleeve PET : suffix is S, Pb-free PVC : suffix is M

◆DC OVERVOLTAGE TEST CONDITIONS

The vent will operate and the capacitor shall become an open circuit without burning materials when the following excess DC voltage is applied.

●Test DC voltage

Rated voltage	Nominal capacitance	Current limit	Test DC voltage
200V _{dc}	<330μF	4A	300/375V _{dc}
	330μF	5A	
400V _{dc}	<100μF	2A	500/600V _{dc}
	100μF ≤ C ≤ 120μF	4A	

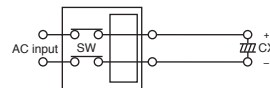
●Test circuit

Constant DC voltage/current power supply

◆RATED RIPPLE CURRENT MULTIPLIERS
●Frequency Multipliers

Frequency (Hz)	50	120	300	1k	10k	50k	100k
4.7 to 10μF	0.65	1.00	1.35	1.75	2.30	2.50	2.70
15 to 47μF	0.75	1.00	1.25	1.50	1.75	1.80	1.85
56 to 330μF	0.80	1.00	1.15	1.30	1.40	1.50	1.60

The endurance of capacitors is reduced with internal heating produced by ripple current at the rate of halving the lifetime with every 5°C rise. When long life performance is required in actual use, the rms ripple current has to be reduced.

KLG Series

- Doesn't spark with DC over voltage
- Endurance with ripple current : 2,000 hours at 105°C
- Non solvent resistant type
- RoHS Compliant

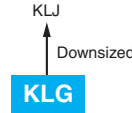

◆ SPECIFICATIONS

Items	Characteristics		
Category	-25 to +105°C		
Temperature Range	-25 to +105°C		
Rated Voltage Range	200 & 400V _{dc}		
Capacitance Tolerance	±20% (M) (at 20°C, 120Hz)		
Leakage Current	I=0.04CV+100 (at 20°C after 1 minute) Where, I : Max. leakage current (μA), C : Nominal capacitance (μF), V : Rated voltage (V)		
Dissipation Factor (tanδ)	Rated voltage (V _{dc})	200V	400V
	tanδ (Max.)	0.20	0.24
Low Temperature Characteristics (Max. Impedance Ratio)	Rated voltage (V _{dc})	200V	400V
	Z(-25°C)/Z(+20°C)	4	6
Endurance	The following specifications shall be satisfied when the capacitors are restored to 20°C after subjected to DC voltage with the rated ripple current is applied (the peak voltage shall not exceed the rated voltage) for 2,000 hours at 105°C.		
	Capacitance change	≤ ±20% of the initial value	
	D.F. (tanδ)	≤ 200% of the initial specified value	
	Leakage current	≤ The initial specified value	
Shelf Life	The following specifications shall be satisfied when the capacitors are restored to 20°C after exposing them for 1,000 hours at 105°C without voltage applied. Before the measurement, the capacitor shall be preconditioned by applying voltage according to Item 4.1 of JIS C 5101-4.		
	Capacitance change	≤ ±20% of the initial value	
	D.F. (tanδ)	≤ 200% of the initial specified value	
	Leakage current	≤ 500% of the initial specified value	

◆ DIMENSIONS [mm]

- Terminal Code : E

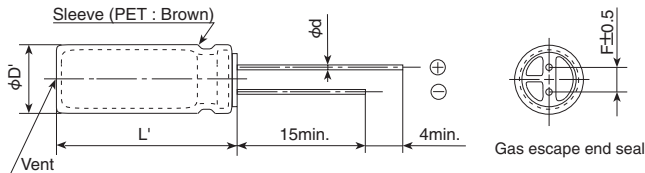

φD	16	18
φd	0.8	
F	7.5	
φD'	φD+0.5max.	
L'	L+1.5max.	

◆ PART NUMBERING SYSTEM

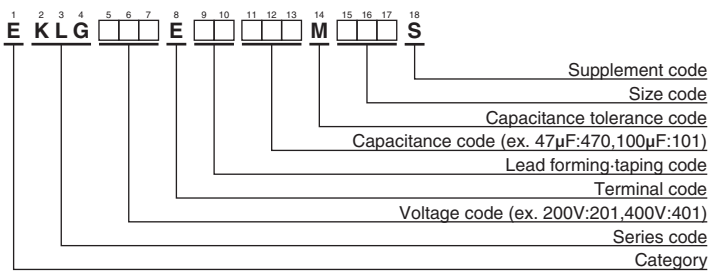

Please refer to "Product code guide (radial lead type)"

◆STANDARD RATINGS

WV (V _{dc})	Cap (μF)	Case size φD×L(mm)	tanδ	Rated ripple current (mA _{rms} /105°C,120Hz)	Part No.
200	82	16×20	0.20	230	EKLG201E□□820ML20S
	100	16×25	0.20	425	EKLG201E□□101ML25S
	100	18×20	0.20	250	EKLG201E□□101MM20S
	120	16×31.5	0.20	500	EKLG201E□□121MLN3S
	120	18×25	0.20	475	EKLG201E□□121MM25S
	130	18×20	0.20	285	EKLG201E□□131MM20S
	150	16×31.5	0.20	560	EKLG201E□□151MLN3S
	150	18×20	0.20	315	EKLG201E□□151MM20S
	150	18×25	0.20	530	EKLG201E□□151MM25S
	180	16×40	0.20	645	EKLG201E□□181ML40S
	180	18×31.5	0.20	630	EKLG201E□□181MMN3S
	220	18×35.5	0.20	725	EKLG201E□□221MMP1S
	220	18×40	0.20	735	EKLG201E□□221MM40S
	270	18×45	0.20	830	EKLG201E□□271MM45S
330	18×45	0.20	920	EKLG201E□□331MM45S	
400	22	16×20	0.24	145	EKLG401E□□220ML20S
	22	16×25	0.24	200	EKLG401E□□220ML25S
	33	16×25	0.24	220	EKLG401E□□330ML25S
	33	18×20	0.24	225	EKLG401E□□330MM20S
	39	16×31.5	0.24	245	EKLG401E□□390MLN3S
	39	18×25	0.24	250	EKLG401E□□390MM25S
	47	16×31.5	0.24	275	EKLG401E□□470MLN3S
	47	18×25	0.24	280	EKLG401E□□470MM25S
	56	16×40	0.24	350	EKLG401E□□560ML40S
	56	18×31.5	0.24	315	EKLG401E□□560MMN3S
	68	18×35.5	0.24	350	EKLG401E□□680MMP1S
	82	18×40	0.24	395	EKLG401E□□820MM40S
	100	18×40	0.24	450	EKLG401E□□101MM40S

□□ : Enter the appropriate lead forming or taping code.

◆DC OVERVOLTAGE TEST CONDITIONS

The vent will operate and the capacitor shall become an open circuit without burning materials when the following excess DC voltage is applied.

●Test DC voltage

Rated voltage	Nominal capacitance	Current limit	Test DC voltage
200V _{dc}	<330μF	4A	300/375V _{dc}
	330μF	5A	
400V _{dc}	<100μF	2A	500/600V _{dc}
	100μF	4A	

●Test circuit

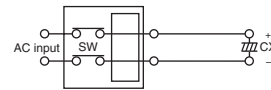

Constant DC voltage/current power supply

◆RATED RIPPLE CURRENT MULTIPLIERS

●Frequency Multipliers

Frequency (Hz)	50	120	300	1k	10k	50k	100k
22 to 47μF	0.75	1.00	1.25	1.50	1.75	1.80	1.85
56 to 330μF	0.80	1.00	1.15	1.30	1.40	1.50	1.60

The endurance of capacitors is reduced with internal heating produced by ripple current at the rate of halving the lifetime with every 5°C rise. When long life performance is required in actual use, the rms ripple current has to be reduced.

New!

LE Series

- Suitable for long life and high reliability products
- Downsize and long life
- Endurance with ripple current : 10,000 hours at 105°C
- Case size range : $\phi 5 \times 11L$ to $\phi 8 \times 11.5L$
- Solvent resistant type (see PRECAUTIONS AND GUIDELINES)
- RoHS Compliant



◆ SPECIFICATION

Items	Characteristics								
Category Temperature Range	-25 to +105°C								
Rated Voltage Range	10 to 100V _{dc}								
Capacitance Tolerance	±20% (M) (at 20°C, 120Hz)								
Leakage Current	I=0.01CV or 3μA, whichever is greater. Where, I : Max. leakage current (μA), C : Nominal capacitance (μF), V : Rated voltage (V) (at 20°C after 2 minutes)								
Dissipation Factor (tanδ)	Rated voltage (V _{dc})	10V	16V	25V	35V	50V	63V	100V	(at 20°C, 120Hz)
	tanδ (Max.)	0.45	0.35	0.30	0.22	0.19	0.17	0.15	
Low Temperature Characteristics (Max. Impedance Ratio)	Rated voltage (V _{dc})	10V	16V	25V	35V	50V	63V	100V	(at 120Hz)
	Z(-25°C)/Z(20°C)	8	6	4	4	3	3	3	
Endurance	The following specifications shall be satisfied when the capacitors are restored to 20°C after subjected to DC voltage with the rated ripple current is applied (the peak voltage shall not exceed the rated voltage) for 10,000 hours at 105°C.								
	Capacitance change	≤ ±25% of the initial value							
	D.F. (tanδ)	≤ 300% of the initial specified value							
	Leakage current	≤ The initial specified value							
Shelf Life	The following specifications shall be satisfied when the capacitors are restored to 20°C after exposing them for 1,000 hours at 105°C without voltage applied. Before the measurement, the capacitor shall be preconditioned by applying voltage according to Item 4.1 of JIS C 5101-4.								
	Capacitance change	≤ ±25% of the initial value							
	D.F. (tanδ)	≤ 300% of the initial specified value							
	Leakage current	≤ The initial specified value							

◆ DIMENSIONS [mm]

● Terminal Code : E

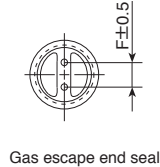
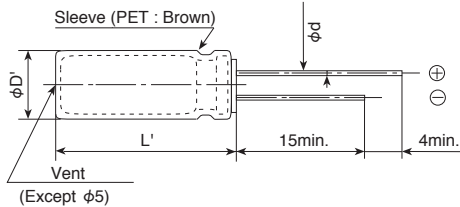

ϕD	5	6.3	8
ϕd	0.5	0.5	0.6
F	2.0	2.5	3.5
$\phi D'$	$\phi D + 0.5 \text{ max.}$		
L'	$L + 1.5 \text{ max.}$		

◆ PART NUMBERING SYSTEM

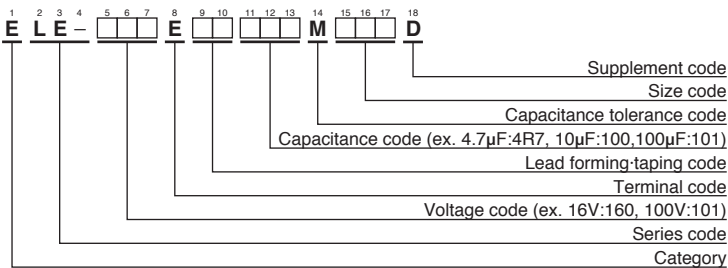

Please refer to "Product code guide (radial lead type)"

New!

LE Series

◆STANDARD RATINGS

WV (V _{dc})	Cap (μF)	Case size φD×L(mm)	tanδ	Rated ripple current (mA _{rms} /105°C, 100kHz)	Part No.
10	100	5×11	0.45	130	ELE-100E□□101ME11D
	220	6.3×11	0.45	210	ELE-100E□□221MF11D
	330	8×11.5	0.45	330	ELE-100E□□331MHB5D
16	47	5×11	0.35	130	ELE-160E□□470ME11D
	100	6.3×11	0.35	210	ELE-160E□□101MF11D
	220	8×11.5	0.35	330	ELE-160E□□221MHB5D
25	33	5×11	0.30	130	ELE-250E□□330ME11D
	47	5×11	0.30	130	ELE-250E□□470ME11D
	100	6.3×11	0.30	210	ELE-250E□□101MF11D
35	33	5×11	0.22	130	ELE-350E□□330ME11D
	47	6.3×11	0.22	210	ELE-350E□□470MF11D
	100	8×11.5	0.22	330	ELE-350E□□101MHB5D
50	1.0	5×11	0.19	25	ELE-500E□□1R0ME11D
	2.2	5×11	0.19	35	ELE-500E□□2R2ME11D
	3.3	5×11	0.19	70	ELE-500E□□3R3ME11D
	4.7	5×11	0.19	80	ELE-500E□□4R7ME11D
	10	5×11	0.19	90	ELE-500E□□100ME11D
	22	5×11	0.19	110	ELE-500E□□220ME11D
	33	6.3×11	0.19	190	ELE-500E□□330MF11D
	47	6.3×11	0.19	190	ELE-500E□□470MF11D
100	8×11.5	0.19	270	ELE-500E□□101MHB5D	
63	10	5×11	0.17	80	ELE-630E□□100ME11D
	22	6.3×11	0.17	170	ELE-630E□□220MF11D
	33	6.3×11	0.17	170	ELE-630E□□330MF11D
	47	8×11.5	0.17	240	ELE-630E□□470MHB5D
100	1.0	5×11	0.15	40	ELE-101E□□1R0ME11D
	2.2	5×11	0.15	50	ELE-101E□□2R2ME11D
	3.3	5×11	0.15	60	ELE-101E□□3R3ME11D
	4.7	5×11	0.15	70	ELE-101E□□4R7ME11D
	10	6.3×11	0.15	150	ELE-101E□□100MF11D
	22	8×11.5	0.15	230	ELE-101E□□220MHB5D

□□ : Enter the appropriate lead forming or taping code.

◆RATED RIPPLE CURRENT MULTIPLIERS

●Frequency Multipliers

Capacitance(μF)	Frequency(Hz)			
	120	1k	10k	100k
1.0 to 10	0.42	0.60	0.80	1.00
22 to 33	0.55	0.75	0.90	1.00
47 to 330	0.70	0.85	0.95	1.00

The endurance of capacitors is reduced with internal heating produced by ripple current at the rate of halving the lifetime with every 5°C rise. When long life performance is required in actual use, the rms ripple current has to be reduced.

FL Series

- Long life and high reliability for $\phi 4 \times 5L$ to $\phi 8 \times 7L$ mm range
- Endurance with ripple current : 3,000 hours at 105°C
- Suitable for long life and high reliability products
- Solvent resistant type (see PRECAUTIONS AND GUIDELINES)
- RoHS Compliant



◆ SPECIFICATIONS

Items	Characteristics							
Category Temperature Range	-40 to +105°C							
Rated Voltage Range	6.3 to 50V _{dc}							
Capacitance Tolerance	±20% (M) (at 20°C, 120Hz)							
Leakage Current	I=0.03CV or 3μA, whichever is greater. Where, I : Max. leakage current (μA), C : Nominal capacitance (μF), V : Rated voltage (V) (at 20°C after 2 minutes)							
Dissipation Factor (tanδ)	Rated voltage (V _{dc})	6.3V	10V	16V	25V	35V	50V	(at 20°C, 120Hz)
	tanδ (Max.)	0.50	0.40	0.35	0.30	0.25	0.25	
Endurance	The following specifications shall be satisfied when the capacitors are restored to 20°C after subjected to DC voltage with the rated ripple current is applied (the peak voltage shall not exceed the rated voltage) for 3,000 hours at 105°C.							
	Capacitance change	≤ ±30% of the initial value						
	D.F. (tanδ)	≤ 300% of the initial specified value						
	Leakage current	≤ The initial specified value						
Shelf Life	The following specifications shall be satisfied when the capacitors are restored to 20°C after exposing them for 1,000 hours at 105°C without voltage applied. Before the measurement, the capacitor shall be preconditioned by applying voltage according to Item 4.1 of JIS C 5101-4.							
	Capacitance change	≤ ±20% of the initial value						
	D.F. (tanδ)	≤ 200% of the initial specified value						
	Leakage current	≤ The initial specified value						

◆ DIMENSIONS [mm]

- Terminal Code : E

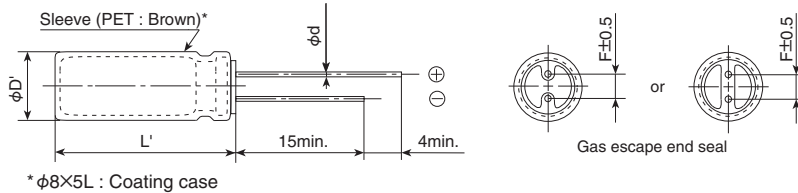

5mm Height

φD	4	5	6.3	8
φd	0.45	0.45	0.45	0.45
F	1.5	2.0	2.5	2.5
φD'	φD+0.5max.			
L'	L+1.0max.			

7mm Height

φD	4	5	6.3	8
φd	0.45	0.45	0.45	0.45
F	1.5	2.0	2.5	3.5
φD'	φD+0.5max.			
L'	L+1.0max.			

◆ PART NUMBERING SYSTEM

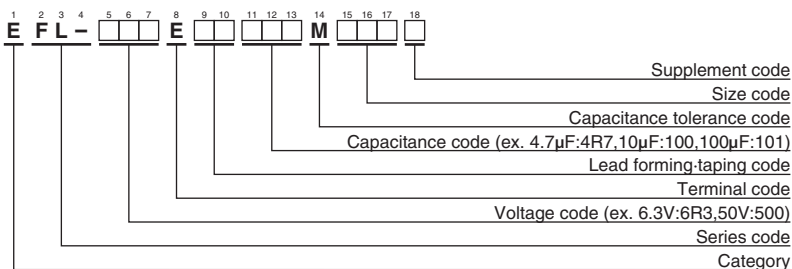

Please refer to "Product code guide (radial lead type)"

◆STANDARD RATINGS

WV (Vdc)	Cap (μF)	Case size $\phi D \times L$ (mm)	$\tan\delta$	Impedance ($\Omega_{\max}/20^\circ\text{C}, 100\text{kHz}$)	Rated ripple current (mA _{rms} /105°C, 100kHz)	Part No.
6.3	33	4×5	0.50	5.4	37	EFL-6R3E□□330MD05D
	47	4×7	0.50	4.5	44	EFL-6R3E□□470MD07D
	56	5×5	0.50	3.1	57	EFL-6R3E□□560ME05D
	82	5×7	0.50	2.5	70	EFL-6R3E□□820ME07D
	100	6.3×5	0.50	1.7	82	EFL-6R3E□□101MF05D
	150	6.3×7	0.50	1.3	116	EFL-6R3E□□151MF07D
	220	8×5	0.50	1.5	110	EFL-6R3E□□221MH05G
270	8×7	0.50	0.90	162	EFL-6R3E□□271MH07D	
10	22	4×5	0.40	5.4	37	EFL-100E□□220MD05D
	33	4×7	0.40	4.5	44	EFL-100E□□330MD07D
	33	5×5	0.40	3.1	57	EFL-100E□□330ME05D
	47	5×7	0.40	2.5	70	EFL-100E□□470ME07D
	68	6.3×5	0.40	1.7	82	EFL-100E□□680MF05D
	100	6.3×7	0.40	1.3	116	EFL-100E□□101MF07D
	150	8×5	0.40	1.5	110	EFL-100E□□151MH05G
220	8×7	0.40	0.90	162	EFL-100E□□221MH07D	
16	15	4×5	0.35	5.4	37	EFL-160E□□150MD05D
	22	4×7	0.35	4.5	44	EFL-160E□□220MD07D
	22	5×5	0.35	3.1	57	EFL-160E□□220ME05D
	33	5×7	0.35	2.5	70	EFL-160E□□330ME07D
	47	6.3×5	0.35	1.7	82	EFL-160E□□470MF05D
	68	6.3×7	0.35	1.3	116	EFL-160E□□680MF07D
	100	8×5	0.35	1.5	110	EFL-160E□□101MH05G
150	8×7	0.35	0.90	162	EFL-160E□□151MH07D	
25	10	4×5	0.30	5.4	37	EFL-250E□□100MD05D
	15	4×7	0.30	4.5	44	EFL-250E□□150MD07D
	15	5×5	0.30	3.1	57	EFL-250E□□150ME05D
	22	5×7	0.30	2.5	70	EFL-250E□□220ME07D
	33	6.3×5	0.30	1.7	82	EFL-250E□□330MF05D
	56	6.3×7	0.30	1.3	116	EFL-250E□□560MF07D
	68	8×5	0.30	1.5	110	EFL-250E□□680MH05G
100	8×7	0.30	0.90	162	EFL-250E□□101MH07D	
35	4.7	4×5	0.25	5.4	37	EFL-350E□□4R7MD05D
	6.8	4×7	0.25	4.5	44	EFL-350E□□6R8MD07D
	10	5×5	0.25	3.1	57	EFL-350E□□100ME05D
	10	5×7	0.25	2.5	70	EFL-350E□□100ME07D
	22	6.3×5	0.25	1.7	82	EFL-350E□□220MF05D
	22	6.3×7	0.25	1.3	116	EFL-350E□□220MF07D
	33	8×5	0.25	1.5	110	EFL-350E□□330MH05G
47	8×7	0.25	0.90	162	EFL-350E□□470MH07D	
50	1.0	4×5	0.25	19	18	EFL-500E□□1R0MD05D
	2.2	4×5	0.25	14	22	EFL-500E□□2R2MD05D
	3.3	4×5	0.25	11	26	EFL-500E□□3R3MD05D
	4.7	4×7	0.25	9.0	30	EFL-500E□□4R7MD07D
	4.7	5×5	0.25	6.0	40	EFL-500E□□4R7ME05D
	6.8	5×7	0.25	4.8	50	EFL-500E□□6R8ME07D
	10	6.3×5	0.25	2.9	63	EFL-500E□□100MF05D
	15	6.3×7	0.25	2.2	90	EFL-500E□□150MF07D
	22	8×5	0.25	2.6	84	EFL-500E□□220MH05G
22	8×7	0.25	1.6	120	EFL-500E□□220MH07D	

□□ : Enter the appropriate lead forming or taping code.

◆RATED RIPPLE CURRENT MULTIPLIERS
●Frequency Multipliers

Capacitance(μF)	Frequency(Hz)			
	120	1k	10k	100k
to 3.3	0.20	0.66	0.90	1.00
4.7 to 6.8	0.35	0.70	0.90	1.00
10 to 150	0.40	0.75	0.90	1.00
220 to 270	0.50	0.85	0.94	1.00

The endurance of capacitors is reduced with internal heating produced by ripple current at the rate of halving the lifetime with every 5°C rise. When long life performance is required in actual use, the rms ripple current has to be reduced.

Upgrade!

GPA Series

- Downsized, low impedance and high-ripple current version of GXE series
- Specified ESR after endurance test
- For high ripple current automotive applications.
(Direct fuel injection and electric power steering etc.)
- Endurance with ripple current : 3,000 to 5,000 hours at 125°C
- Solvent resistant type (see PRECAUTIONS AND GUIDELINES)
- RoHS Compliant

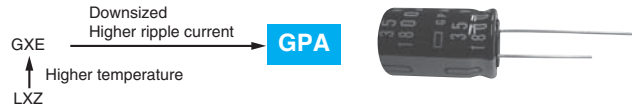

◆ SPECIFICATIONS

Items	Characteristics						
Category	-40 to +125°C						
Temperature Range	-40 to +125°C						
Rated Voltage Range	25 to 100V _{dc}						
Capacitance Tolerance	±20% (M) (at 20°C, 120Hz)						
Leakage Current	I=0.03CV or 4μA, whichever is greater. Where, I : Max. leakage current (μA), C : Nominal capacitance (μF), V : Rated voltage (V) (at 20°C, 1 minute)						
Dissipation Factor (tanδ)	Rated voltage (V _{dc})	25V	35V	50V	63V	80V	100V
	tanδ (Max.)	0.14	0.12	0.10	0.10	0.08	0.08
When nominal capacitance exceeds 1,000μF, add 0.02 to the value above for each 1,000μF increase. (at 20°C, 120Hz)							
Low Temperature Characteristics (Max. Impedance Ratio)	Rated voltage (V _{dc})	25V	35V	50V	63V	80V	100V
	Z(-25°C)/Z(+20°C)	2	2	2	2	2	2
	Z(-40°C)/Z(+20°C)	4	4	4	4	4	4
(at 120Hz)							
Endurance	The following specifications shall be satisfied when the capacitors are restored to 20°C after subjected to DC voltage with the rated ripple current is applied (the peak voltage shall not exceed the rated voltage) for 5,000 hours (3,000 hours for 25L and less) at 125 °C.						
	Capacitance change	≤ ±30% of the initial value					
	D.F. (tanδ)	≤ 300% of the initial specified value					
	Leakage current	≤ The initial specified value					
Shelf Life	The following specifications shall be satisfied when the capacitors are restored to 20°C after exposing them for 1,000 hours at 125°C without voltage applied. Before the measurement, the capacitor shall be preconditioned by applying voltage according to Item 4.1 of JIS C 5101-4.						
	Capacitance change	≤ ±30% of the initial value					
	D.F. (tanδ)	≤ 300% of the initial specified value					
	Leakage current	≤ The initial specified value					

◆ DIMENSIONS [mm]

● Terminal Code : E

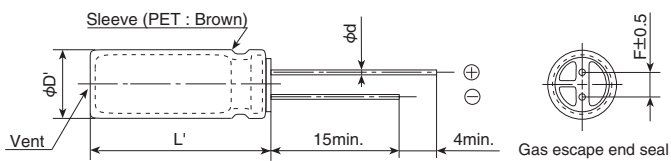

φD	12.5	14.5	16	18
φd	0.6	0.8	0.8	0.8
F	5.0	7.5	7.5	7.5
φD'	φD+0.5max.			
L'	L+1.5max.			

◆ PART NUMBERING SYSTEM

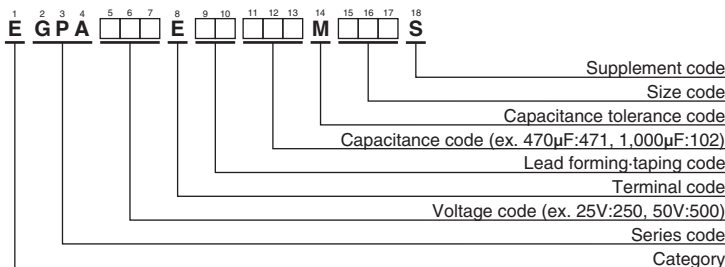

Please refer to "Product code guide (radial lead type)"



Upgrade!

GPA Series

◆STANDARD RATINGS

WV (Vdc)	Cap (μF)	Case size φ D×L(mm)	ESR (Initial) (Ω max/100kHz)		ESR (End of Life) (Ω max/100kHz)		Rated ripple current (mArms/125°C,100kHz)	Part No.
			20°C	-40°C	20°C	-40°C		
25	1,200	12.5×20	0.044	0.22	0.18	2.2	1,820	EGPA250E□□122MK20S
	1,500	14.5×20	0.037	0.19	0.11	1.3	2,100	EGPA250E□□152MU20S
	1,800	12.5×25	0.033	0.17	0.13	1.6	2,280	EGPA250E□□182MK25S
	1,800	16×20	0.034	0.17	0.10	1.3	2,280	EGPA250E□□182ML20S
	2,200	12.5×30	0.029	0.13	0.11	1.3	2,560	EGPA250E□□222MK30S
	2,200	14.5×25	0.028	0.14	0.080	0.90	2,620	EGPA250E□□222MU25S
	2,700	12.5×35	0.024	0.11	0.090	0.80	2,970	EGPA250E□□272MK35S
	2,700	14.5×30	0.023	0.10	0.070	0.70	3,060	EGPA250E□□272MU30S
	2,700	16×25	0.026	0.13	0.080	1.1	2,860	EGPA250E□□272ML25S
	2,700	18×20	0.032	0.16	0.090	0.60	2,490	EGPA250E□□272MM20S
	3,300	12.5×40	0.021	0.095	0.080	0.50	3,340	EGPA250E□□332MK40S
	3,300	14.5×35	0.021	0.095	0.060	0.70	3,380	EGPA250E□□332MU35S
	3,300	16×30	0.023	0.10	0.070	0.90	3,160	EGPA250E□□332ML30S
	3,900	16×35	0.020	0.090	0.060	0.70	3,590	EGPA250E□□392ML35S
	3,900	18×25	0.024	0.12	0.070	0.50	3,010	EGPA250E□□392MM25S
	4,700	14.5×40	0.018	0.081	0.050	0.50	3,730	EGPA250E□□472MU40S
	4,700	18×30	0.022	0.099	0.080	0.60	3,390	EGPA250E□□472MM30S
	5,600	16×40	0.017	0.077	0.040	0.60	3,970	EGPA250E□□562ML40S
5,600	18×35	0.019	0.086	0.070	0.50	3,840	EGPA250E□□562MM35S	
6,800	18×40	0.016	0.072	0.030	0.40	4,230	EGPA250E□□682MM40S	
35	680	12.5×20	0.044	0.22	0.18	2.2	1,820	EGPA350E□□681MK20S
	1,000	12.5×25	0.033	0.17	0.13	1.6	2,280	EGPA350E□□102MK25S
	1,000	14.5×20	0.037	0.19	0.11	1.3	2,100	EGPA350E□□102MU20S
	1,200	12.5×30	0.029	0.13	0.11	1.3	2,560	EGPA350E□□122MK30S
	1,200	16×20	0.034	0.17	0.10	1.3	2,280	EGPA350E□□122ML20S
	1,200	14.5×25	0.028	0.14	0.080	0.90	2,620	EGPA350E□□122MU25S
	1,500	12.5×35	0.024	0.11	0.090	0.80	2,970	EGPA350E□□152MK35S
	1,500	14.5×30	0.023	0.10	0.070	0.70	3,060	EGPA350E□□152MU30S
	1,500	18×20	0.032	0.16	0.090	0.60	2,490	EGPA350E□□152MM20S
	1,800	12.5×40	0.021	0.095	0.080	0.50	3,340	EGPA350E□□182MK40S
	1,800	16×25	0.026	0.13	0.080	1.1	2,860	EGPA350E□□182ML25S
	2,200	14.5×35	0.021	0.095	0.060	0.70	3,380	EGPA350E□□222MU35S
	2,200	16×30	0.023	0.10	0.070	0.90	3,160	EGPA350E□□222ML30S
	2,200	18×25	0.024	0.12	0.070	0.50	3,010	EGPA350E□□222MM25S
	2,700	14.5×40	0.018	0.081	0.050	0.50	3,730	EGPA350E□□272MU40S
	2,700	16×35	0.020	0.090	0.060	0.70	3,590	EGPA350E□□272ML35S
	2,700	18×30	0.022	0.099	0.080	0.60	3,390	EGPA350E□□272MM30S
	3,300	16×40	0.017	0.077	0.040	0.60	3,970	EGPA350E□□332ML40S
3,300	18×35	0.019	0.086	0.070	0.50	3,840	EGPA350E□□332MM35S	
4,700	18×40	0.016	0.072	0.030	0.40	4,230	EGPA350E□□472MM40S	
50	470	12.5×20	0.065	0.33	0.18	2.2	1,500	EGPA500E□□471MK20S
	560	14.5×20	0.055	0.28	0.11	1.3	1,740	EGPA500E□□561MU20S
	680	12.5×25	0.048	0.24	0.13	1.6	1,900	EGPA500E□□681MK25S
	680	16×20	0.043	0.22	0.10	1.3	2,040	EGPA500E□□681ML20S
	820	12.5×30	0.041	0.18	0.11	1.3	2,150	EGPA500E□□821MK30S
	820	14.5×25	0.040	0.20	0.080	0.90	2,190	EGPA500E□□821MU25S
	1,000	12.5×35	0.034	0.15	0.090	0.80	2,510	EGPA500E□□102MK35S
	1,000	14.5×30	0.036	0.16	0.070	0.70	2,470	EGPA500E□□102MU30S
	1,000	16×25	0.031	0.16	0.080	1.1	2,620	EGPA500E□□102ML25S
	1,000	18×20	0.039	0.20	0.090	0.60	2,240	EGPA500E□□102MM20S
	1,200	12.5×40	0.028	0.13	0.080	0.50	2,870	EGPA500E□□122MK40S
	1,200	14.5×35	0.029	0.13	0.060	0.70	2,840	EGPA500E□□122MU35S
	1,200	16×30	0.027	0.13	0.070	0.90	2,940	EGPA500E□□122ML30S
	1,200	18×25	0.029	0.15	0.070	0.50	2,750	EGPA500E□□122MM25S
	1,500	16×35	0.023	0.10	0.060	0.70	3,300	EGPA500E□□152ML35S
	1,800	14.5×40	0.024	0.11	0.050	0.50	3,230	EGPA500E□□182MU40S
	1,800	18×30	0.026	0.12	0.080	0.60	3,140	EGPA500E□□182MM30S
	2,200	16×40	0.020	0.090	0.040	0.60	3,720	EGPA500E□□222ML40S
2,200	18×35	0.022	0.10	0.070	0.50	3,510	EGPA500E□□222MM35S	
2,700	18×40	0.018	0.080	0.030	0.40	3,940	EGPA500E□□272MM40S	

□□ : Enter the appropriate lead forming or taping code.



Upgrade!

GPA Series

◆STANDARD RATINGS

WV (Vdc)	Cap (μF)	Case size φD×L(mm)	ESR (Initial) (Ω max/100kHz)		ESR (End of Life) (Ω max/100kHz)		Rated ripple current (mA rms/125°C, 100kHz)	Part No.
			20°C	-40°C	20°C	-40°C		
63	470	16×20	0.085	0.58	0.19	3.0	1,790	EGPA630E□□471ML20S
	680	16×25	0.061	0.48	0.14	2.0	2,030	EGPA630E□□681ML25S
	680	18×20	0.070	0.49	0.19	3.0	1,910	EGPA630E□□681MM20S
	820	16×30	0.053	0.41	0.090	1.3	2,330	EGPA630E□□821ML30S
	1,000	16×35	0.044	0.33	0.070	0.90	2,580	EGPA630E□□102ML35S
	1,000	18×25	0.049	0.34	0.14	2.0	2,280	EGPA630E□□102MM25S
	1,200	16×40	0.036	0.26	0.060	0.80	2,900	EGPA630E□□122ML40S
	1,200	18×30	0.041	0.26	0.090	1.3	2,580	EGPA630E□□122MM30S
	1,500	18×35	0.035	0.21	0.070	0.90	2,890	EGPA630E□□152MM35S
	1,800	18×40	0.030	0.18	0.060	0.80	3,210	EGPA630E□□182MM40S
80	330	16×20	0.085	0.58	0.19	3.0	1,790	EGPA800E□□331ML20S
	470	16×25	0.061	0.48	0.14	2.0	2,030	EGPA800E□□471ML25S
	470	18×20	0.070	0.49	0.19	3.0	1,910	EGPA800E□□471MM20S
	560	16×30	0.053	0.41	0.090	1.3	2,330	EGPA800E□□561ML30S
	560	18×25	0.049	0.34	0.14	2.0	2,280	EGPA800E□□561MM25S
	680	16×35	0.044	0.33	0.070	0.90	2,580	EGPA800E□□681ML35S
	680	18×30	0.041	0.26	0.090	1.3	2,580	EGPA800E□□681MM30S
	820	16×40	0.036	0.26	0.060	0.80	2,900	EGPA800E□□821ML40S
	820	18×35	0.035	0.21	0.070	0.90	2,890	EGPA800E□□821MM35S
	1,200	18×40	0.030	0.18	0.060	0.80	3,210	EGPA800E□□122MM40S
100	200	16×20	0.11	0.88	0.25	3.9	1,580	EGPA101E□□201ML20S
	270	18×20	0.091	0.73	0.22	3.9	1,690	EGPA101E□□271MM20S
	300	16×25	0.079	0.72	0.18	2.7	1,990	EGPA101E□□301ML25S
	360	16×30	0.068	0.62	0.13	1.9	2,250	EGPA101E□□361ML30S
	390	18×25	0.064	0.50	0.15	2.7	2,110	EGPA101E□□391MM25S
	470	16×35	0.056	0.50	0.090	1.3	2,500	EGPA101E□□471ML35S
	510	18×30	0.054	0.39	0.13	1.9	2,410	EGPA101E□□511MM30S
	560	16×40	0.046	0.39	0.080	1.1	2,700	EGPA101E□□561ML40S
	620	18×35	0.044	0.32	0.090	1.3	2,690	EGPA101E□□621MM35S
	750	18×40	0.039	0.27	0.080	1.1	2,880	EGPA101E□□751MM40S

□□ : Enter the appropriate lead forming or taping code.

◆RATED RIPPLE CURRENT MULTIPLIERS

●Frequency Multipliers

Capacitance(μF) \ Frequency(Hz)	120	1k	10k	100k
200	0.40	0.82	0.93	1.00
270 to 560	0.50	0.85	0.94	1.00
620 to 1,800	0.60	0.87	0.95	1.00
2,200 to 3,900	0.75	0.90	0.95	1.00
4,700 to 6,800	0.85	0.95	0.98	1.00

The endurance of capacitors is reduced with internal heating produced by ripple current at the rate of halving the lifetime with every 5°C rise. When long life performance is required in actual use, the rms ripple current has to be reduced.

GXE Series

- For automobile modules and other high temperature applications
- Downsize, long life, low impedance and better low temperature characteristics
- Endurance with ripple current : 2,000 to 5,000 hours at 125°C
- Solvent resistant type except 63 to 450V (see PRECAUTIONS AND GUIDELINES)
- RoHS Compliant



◆ SPECIFICATIONS

Items	Characteristics										
Category	-40 to +125°C (10 to 250V _{dc}) -25 to +125°C (350 to 450V _{dc})										
Temperature Range											
Rated Voltage Range	10 to 450V _{dc}										
Capacitance Tolerance	±20% (M) (at 20°C, 120Hz)										
Leakage Current	10 to 100V _{dc}					160 to 450V _{dc}					
	I=0.03CV or 4µA, whichever is greater.					CV≤1,000 I=0.1CV+40					
						CV>1,000 I=0.04CV+100					
Where, I : Max. leakage current (µA), C : Nominal capacitance (µF), V : Rated voltage (V) (at 20°C, 1 minute)											
Dissipation Factor (tanδ)	Rated voltage (V _{dc})	10V	16V	25V	35V	50V	63V	80V	100V	160 to 250V	350 to 450V
	tanδ (Max.)	0.20	0.16	0.14	0.12	0.10	0.10	0.08	0.08	0.20	0.24
When nominal capacitance exceeds 1,000µF, add 0.02 to the value above for each 1,000µF increase. (at 20°C, 120Hz)											
Low Temperature Characteristics (Max. Impedance Ratio)	Rated voltage (V _{dc})	10V	16V	25V	35V	50V	63V	80V	100V	160 to 250V	350 to 450V
	Z(-25°C)/Z(+20°C)	3	2	2	2	2	2	2	2	3	6
	Z(-40°C)/Z(+20°C)	6	4	4	4	4	4	4	4	6	—
(at 120Hz)											
Endurance	The following specifications shall be satisfied when the capacitors are restored to 20°C after subjected to DC voltage with the rated ripple current is applied (the peak voltage shall not exceed the rated voltage) for the specified time at 125°C.										
		10 to 100V _{dc}					160 to 450V _{dc}				
	Time	φ8 : 2,000hours φ10 : 3,000hours φ12.5 & φ16 : 5,000hours					2,000hours				
	Capacitance change	≤±30% of the initial value					≤±20% of the initial value				
	D.F. (tanδ)	≤300% of the initial specified value					≤200% of the initial specified value				
Leakage current	≤The initial specified value					≤The initial specified value					
Shelf Life	The following specifications shall be satisfied when the capacitors are restored to 20°C after exposing them for 1,000 hours (500 hours for 350 to 450V _{dc}) at 125°C without voltage applied. Before the measurement, the capacitor shall be preconditioned by applying voltage according to Item 4.1 of JIS C 5101-4.										
		10 to 100V _{dc}					160 to 450V _{dc}				
	Capacitance change	≤±30% of the initial value					≤±20% of the initial value				
	D.F. (tanδ)	≤300% of the initial specified value					≤200% of the initial specified value				
	Leakage current	≤The initial specified value					≤500% of the initial specified value				

◆ DIMENSIONS [mm]

- Terminal Code : E

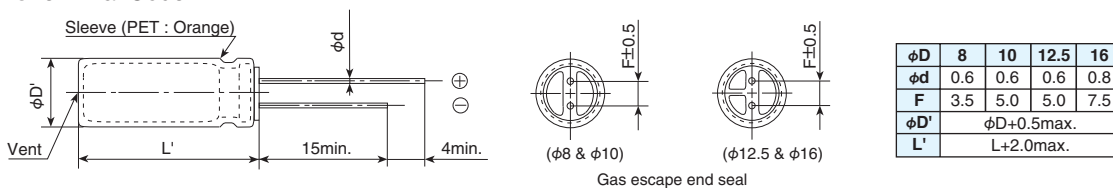

◆ PART NUMBERING SYSTEM

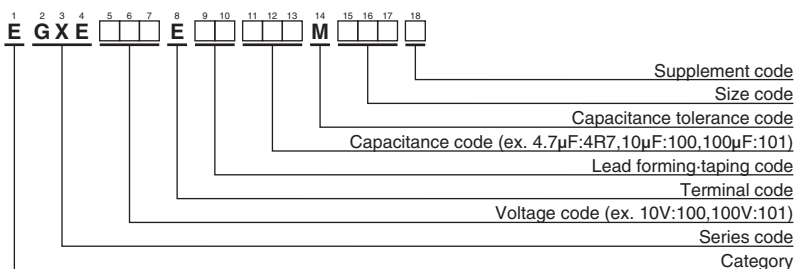

Please refer to "Product code guide (radial lead type)"

◆STANDARD RATINGS

□ is not solvent resistant.

VV (Vdc)	Cap (μF)	Case size φD×L(mm)	Impedance (Ωmax/20°C, 100kHz)	Rated ripple current (mA _{rms} /125°C, Note1)	Part No.	VV (Vdc)	Cap (μF)	Case size φD×L(mm)	Impedance (Ωmax/20°C, 100kHz)	Rated ripple current (mA _{rms} /125°C, Note1)	Part No.	
10	220	8×12	0.32	340	EGXE100E□□221MH12D	80	47	10×12.5	0.80	480	EGXE800E□□470MJC5S	
	330	10×12.5	0.15	620	EGXE100E□□331MJC5S		100	10×20	0.39	790	EGXE800E□□101MJ20S	
	470	10×12.5	0.15	620	EGXE100E□□471MJC5S		220	12.5×25	0.18	1,240	EGXE800E□□221MK25S	
	1,000	10×20	0.075	950	EGXE100E□□102MJ20S		330	12.5×30	0.16	1,390	EGXE800E□□331MK30S	
	2,200	12.5×25	0.040	1,350	EGXE100E□□222MK25S		470	16×25	0.11	1,500	EGXE800E□□471ML25S	
	3,300	16×25	0.031	1,620	EGXE100E□□332ML25S		100	4.7	8×12	2.0	130	EGXE101E□□4R7MH12D
	4,700	16×31.5	0.025	1,860	EGXE100E□□472MLN3S			10	8×12	1.5	150	EGXE101E□□100MH12D
16	100	8×12	0.32	340	EGXE160E□□101MH12D	22		10×12.5	0.80	480	EGXE101E□□220MJC5S	
	220	10×12.5	0.15	620	EGXE160E□□221MJC5S	33		10×12.5	0.80	480	EGXE101E□□330MJC5S	
	330	10×12.5	0.15	620	EGXE160E□□331MJC5S	47		10×16	0.55	630	EGXE101E□□470MJ16S	
	470	10×16	0.094	790	EGXE160E□□471MJ16S	100		12.5×20	0.25	990	EGXE101E□□101MK20S	
	1,000	12.5×20	0.058	1,080	EGXE160E□□102MK20S	220		16×25	0.11	1,500	EGXE101E□□221ML25S	
	2,200	16×25	0.031	1,620	EGXE160E□□222ML25S	330	16×31.5	0.079	1,790	EGXE101E□□331MLN3S		
	3,300	16×31.5	0.025	1,860	EGXE160E□□332MLN3S	160	22	10×20	—	115	EGXE161E□□220MJ20S	
25	100	8×12	0.32	340	EGXE250E□□101MH12D		33	10×25	—	154	EGXE161E□□330MJ25S	
	220	10×12.5	0.15	620	EGXE250E□□221MJC5S		47	12.5×20	—	187	EGXE161E□□470MK20S	
	330	10×16	0.094	790	EGXE250E□□331MJ16S		68	12.5×25	—	245	EGXE161E□□680MK25S	
	470	10×20	0.075	950	EGXE250E□□471MJ20S		100	16×25	—	329	EGXE161E□□101ML25S	
	1,000	12.5×25	0.040	1,350	EGXE250E□□102MK25S		150	16×31.5	—	434	EGXE161E□□151MLN3S	
	2,200	16×31.5	0.025	1,860	EGXE250E□□222MLN3S		200	10	10×20	—	78	EGXE201E□□100MJ20S
	35	100	8×12	0.32	340	EGXE350E□□101MH12D		22	10×25	—	126	EGXE201E□□220MJ25S
100		10×12.5	0.15	620	EGXE350E□□101MJC5S	33		12.5×20	—	157	EGXE201E□□330MK20S	
220		10×16	0.094	790	EGXE350E□□221MJ16S	47		12.5×25	—	204	EGXE201E□□470MK25S	
330		10×20	0.075	950	EGXE350E□□331MJ20S	68		16×20	—	250	EGXE201E□□680ML20S	
470		12.5×20	0.058	1,080	EGXE350E□□471MK20S	100		16×25	—	329	EGXE201E□□101ML25S	
1,000		16×25	0.031	1,620	EGXE350E□□102ML25S	250		10	10×20	—	78	EGXE251E□□100MJ20S
50		10	8×12	0.75	180		EGXE500E□□100MH12D	22	12.5×20	—	128	EGXE251E□□220MK20S
	22	8×12	0.50	250	EGXE500E□□220MH12D		33	12.5×25	—	171	EGXE251E□□330MK25S	
	33	8×12	0.50	280	EGXE500E□□330MH12D		47	16×25	—	225	EGXE251E□□470ML25S	
	47	8×12	0.50	280	EGXE500E□□470MH12D		68	16×31.5	—	292	EGXE251E□□680MLN3S	
	100	10×12.5	0.20	520	EGXE500E□□101MJC5S	350	4.7	10×20	—	53	EGXE351E□□4R7MJ20S	
220	10×20	0.098	880	EGXE500E□□221MJ20S	10		10×25	—	85	EGXE351E□□100MJ25S		
330	12.5×20	0.081	990	EGXE500E□□331MK20S	22		12.5×25	—	139	EGXE351E□□220MK25S		
470	12.5×25	0.059	1,150	EGXE500E□□471MK25S	33		16×25	—	189	EGXE351E□□330ML25S		
1,000	16×31.5	0.032	1,590	EGXE500E□□102MLN3S	47		16×31.5	—	243	EGXE351E□□470MLN3S		
63	33	8×12	1.5	150	EGXE630E□□330MH12D	400	4.7	10×20	—	53	EGXE401E□□4R7MJ20S	
	47	10×12.5	0.59	530	EGXE630E□□470MJC5S		10	10×25	—	86	EGXE401E□□100MJ25S	
	100	10×16	0.41	690	EGXE630E□□101MJ16S		22	12.5×30	—	142	EGXE401E□□220MK30S	
	220	12.5×20	0.16	1,050	EGXE630E□□221MK20S		33	16×25	—	189	EGXE401E□□330ML25S	
	330	12.5×25	0.12	1,290	EGXE630E□□331MK25S		47	16×31.5	—	243	EGXE401E□□470MLN3S	
	470	12.5×30	0.097	1,460	EGXE630E□□471MK30S		450	4.7	10×25	—	58	EGXE451E□□4R7MJ25S
	1,000	16×31.5	0.059	1,850	EGXE630E□□102MLN3S			10	12.5×20	—	86	EGXE451E□□100MK20S
22	8×12	1.5	150	EGXE800E□□220MH12D	22	16×25		—	154	EGXE451E□□220ML25S		
80	33	10×12.5	0.8	480	EGXE800E□□330MJC5S	33	16×31.5	—	203	EGXE451E□□330MLN3S		

□□ : Enter the appropriate lead forming or taping code.
 (Note1) Ripple current frequency
 10 to 100V = 100kHz
 160 to 450V = 120Hz

◆RATED RIPPLE CURRENT MULTIPLIERS

●(10 to 100Vdc) Frequency Multipliers

Capacitance (μF)	Frequency (Hz)	120	1k	10k	100k
4.7 to 100		0.40	0.75	0.90	1.00
220 to 470		0.50	0.85	0.94	1.00
1,000		0.60	0.87	0.95	1.00
2,200 to 3,300		0.75	0.90	0.95	1.00
4,700		0.85	0.95	0.98	1.00

●(160 to 450Vdc) Frequency Multipliers

Capacitance (μF)	Frequency (Hz)	50	120	300	1k	10k	100k
4.7 to 33		0.75	1.00	1.25	1.50	1.75	1.80
47 to 150		0.80	1.00	1.15	1.30	1.40	1.50

The endurance of capacitors is reduced with internal heating produced by ripple current at the rate of halving the lifetime with every 5°C rise. When long life performance is required in actual use, the rms ripple current has to be reduced.

GXL Series

- Long-Life version of GXE series
- For automobile modules and other high temperature applications
- Endurance with ripple current : 5,000 hours at 125°C
- Solvent resistant type (see PRECAUTIONS AND GUIDELINES)
- RoHS Compliant



◆ SPECIFICATIONS

Items	Characteristics					
Category	-40 to +125°C					
Temperature Range	-40 to +125°C					
Rated Voltage Range	10 to 50V _{dc}					
Capacitance Tolerance	±20% (M) (at 20°C, 120Hz)					
Leakage Current	I=0.03CV or 4μA, whichever is greater. (at 20°C, 1 minute) Where, I : Max. leakage current (μA), C : Nominal capacitance (μF), V : Rated voltage (V)					
Dissipation Factor (tanδ)	Rated voltage (V _{dc})	10V	16V	25V	35V	50V
	tanδ (Max.)	0.20	0.16	0.14	0.12	0.10
Low Temperature Characteristics (Max. Impedance Ratio)	Rated voltage (V _{dc})	10V	16V	25V	35V	50V
	Z(-25°C)/Z(+20°C)	3	2	2	2	2
	Z(-40°C)/Z(+20°C)	6	4	4	4	4
Endurance	The following specifications shall be satisfied when the capacitors are restored to 20°C after subjected to DC voltage with the rated ripple current is applied (the peak voltage shall not exceed the rated voltage) for 5,000 hours at 125°C.					
	Capacitance change	≤±30% of the initial value				
	D.F. (tanδ)	≤300% of the initial specified value				
	Leakage current	≤The initial specified value				
Shelf Life	The following specifications shall be satisfied when the capacitors are restored to 20°C after exposing them for 1,000 hours at 125°C without voltage applied. Before the measurement, the capacitor shall be preconditioned by applying voltage according to Item 4.1 of JIS C 5101-4.					
	Capacitance change	≤±30% of the initial value				
	D.F. (tanδ)	≤300% of the initial specified value				
	Leakage current	≤The initial specified value				

◆ DIMENSIONS [mm]

- Terminal Code : E

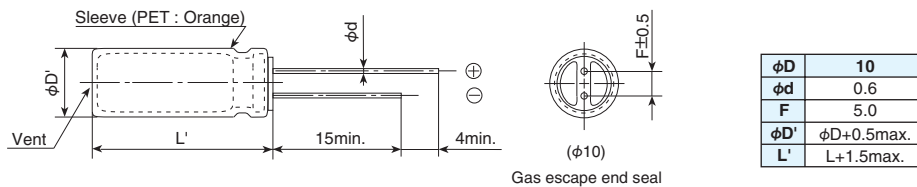

◆ PART NUMBERING SYSTEM

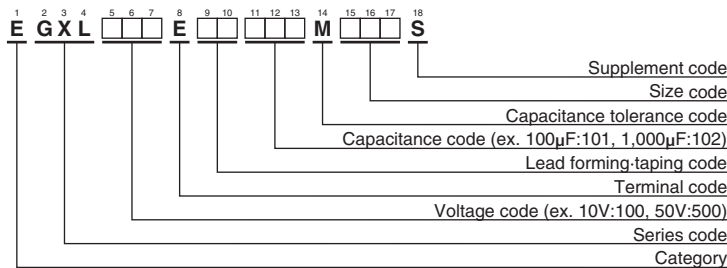

Please refer to "Product code guide (radial lead type)"

◆STANDARD RATINGS

WV (Vdc)	Cap (μF)	Case size φD×L(mm)	Impedance (Ω max/20°C, 100kHz)	Rated ripple current (mA rms/125°C, 100kHz)	Part No.
10	330	10 × 12.5	0.17	800	EGXL100E□□331MJC5S
	470	10 × 12.5	0.17	800	EGXL100E□□471MJC5S
	1,000	10 × 20	0.094	1,300	EGXL100E□□102MJ20S
16	220	10 × 12.5	0.17	800	EGXL160E□□221MJC5S
	330	10 × 12.5	0.17	800	EGXL160E□□331MJC5S
	470	10 × 16	0.12	1,050	EGXL160E□□471MJ16S
25	220	10 × 12.5	0.17	800	EGXL250E□□221MJC5S
	330	10 × 16	0.12	1,050	EGXL250E□□331MJ16S
	470	10 × 20	0.094	1,300	EGXL250E□□471MJ20S
35	100	10 × 12.5	0.17	800	EGXL350E□□101MJC5S
	220	10 × 16	0.12	1,050	EGXL350E□□221MJ16S
	330	10 × 20	0.094	1,300	EGXL350E□□331MJ20S
50	100	10 × 12.5	0.30	590	EGXL500E□□101MJC5S
	220	10 × 20	0.19	970	EGXL500E□□221MJ20S

□□ : Enter the appropriate lead forming or taping code.

◆RATED RIPPLE CURRENT MULTIPLIERS
●Frequency Multipliers

Capacitance(μF)	Frequency(Hz)	120	1k	10k	100k
100		0.40	0.75	0.90	1.00
220 to 470		0.50	0.85	0.94	1.00
1,000		0.60	0.87	0.95	1.00

The endurance of capacitors is reduced with internal heating produced by ripple current at the rate of halving the lifetime with every 5°C rise. When long life performance is required in actual use, the rms ripple current has to be reduced.

GXH Series

- For automobile modules and other high temperature applications
- Endurance with ripple current : 1,500 to 2,000 hours at 135°C
- Solvent resistant type (see PRECAUTIONS AND GUIDELINES)
- RoHS Compliant

GXE $\xrightarrow{\text{Higher temperature}}$ GXH



SPECIFICATIONS

Items	Characteristics					
Category	-40 to +135°C					
Temperature Range	-40 to +135°C					
Rated Voltage Range	10 to 50V _{dc}					
Capacitance Tolerance	±20% (M) (at 20°C, 120Hz)					
Leakage Current	I=0.03CV or 4μA, whichever is greater. Where, I : Max. leakage current (μA), C : Nominal capacitance (μF), V : Rated voltage (V) (at 20°C, 1 minute)					
Dissipation Factor (tanδ)	Rated voltage (V _{dc})	10V	16V	25V	35V	50V
	tanδ (Max.)	0.20	0.16	0.14	0.12	0.10
	When nominal capacitance exceeds 1,000μF, add 0.02 to the value above for each 1,000μF increase. (at 20°C, 120Hz)					
Low Temperature Characteristics (Max. Impedance Ratio)	Rated voltage (V _{dc})	10V	16V	25V	35V	50V
	Z(-25°C)/Z(+20°C)	3	2	2	2	2
	Z(-40°C)/Z(+20°C)	6	4	4	4	4
	(at 120Hz)					
Endurance	The following specifications shall be satisfied when the capacitors are restored to 20°C after subjected to DC voltage with the rated ripple current is applied (the peak voltage shall not exceed the rated voltage) for the specified time at 135°C.					
	Time	φ10 : 1,500hours		φ12.5 & φ16 : 2,000hours		
	Capacitance change	≤±30% of the initial value				
	D.F. (tanδ)	≤300% of the initial specified value				
	Leakage current	≤The initial specified value				
Shelf Life	The following specifications shall be satisfied when the capacitors are restored to 20°C after exposing them for 1,000 hours at 135°C without voltage applied. Before the measurement, the capacitor shall be preconditioned by applying voltage according to Item 4.1 of JIS C 5101-4.					
	Capacitance change	≤±30% of the initial value				
	D.F. (tanδ)	≤300% of the initial specified value				
	Leakage current	≤The initial specified value				

DIMENSIONS [mm]

- Terminal Code : E

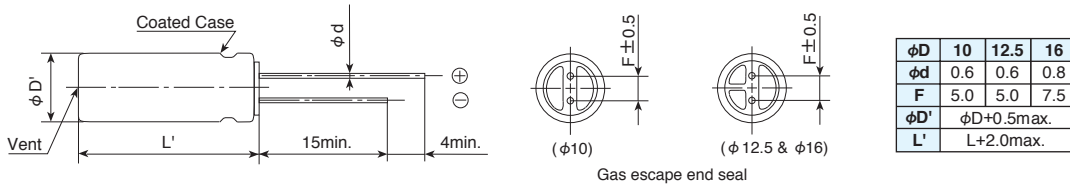

PART NUMBERING SYSTEM

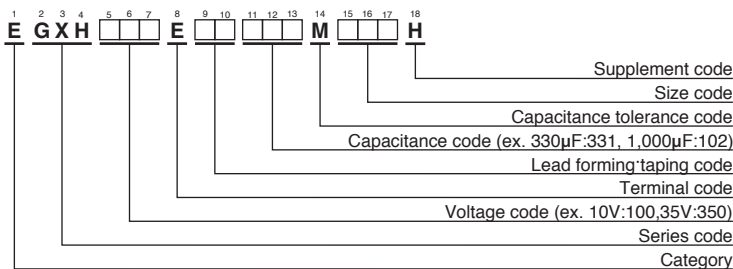

Please refer to "Product code guide (radial lead type)"

MARKING

EX) 35V470μF



◆STANDARD RATINGS

WV (Vdc)	Cap (μF)	Case size φD×L(mm)	Impedance (Ω _{max} /20°C, 100kHz)	Rated ripple current (mA _{rms} /135°C, 100kHz)	Part No.
10	330	10 × 12.5	0.15	620	EGXH100E□□331MJC5H
	470	10 × 12.5	0.15	620	EGXH100E□□471MJC5H
	1,000	10 × 20	0.075	950	EGXH100E□□102MJ20H
	2,200	12.5 × 25	0.040	1,350	EGXH100E□□222MK25H
	3,300	16 × 25	0.031	1,620	EGXH100E□□332ML25H
	4,700	16 × 31.5	0.025	1,860	EGXH100E□□472MLN3H
16	220	10 × 12.5	0.15	620	EGXH160E□□221MJC5H
	330	10 × 12.5	0.15	620	EGXH160E□□331MJC5H
	470	10 × 16	0.094	790	EGXH160E□□471MJ16H
	1,000	12.5 × 20	0.058	1,080	EGXH160E□□102MK20H
	2,200	16 × 25	0.031	1,620	EGXH160E□□222ML25H
	3,300	16 × 31.5	0.025	1,860	EGXH160E□□332MLN3H
25	220	10 × 12.5	0.15	620	EGXH250E□□221MJC5H
	330	10 × 16	0.094	790	EGXH250E□□331MJ16H
	470	10 × 20	0.075	950	EGXH250E□□471MJ20H
	1,000	12.5 × 25	0.040	1,350	EGXH250E□□102MK25H
	2,200	16 × 31.5	0.025	1,860	EGXH250E□□222MLN3H
35	100	10 × 12.5	0.15	620	EGXH350E□□101MJC5H
	220	10 × 16	0.094	790	EGXH350E□□221MJ16H
	330	10 × 20	0.075	950	EGXH350E□□331MJ20H
	470	12.5 × 20	0.058	1,080	EGXH350E□□471MK20H
	1,000	16 × 25	0.031	1,620	EGXH350E□□102ML25H
50	100	10 × 12.5	0.20	520	EGXH500E□□101MJC5H
	220	10 × 20	0.098	880	EGXH500E□□221MJ20H
	330	12.5 × 20	0.081	990	EGXH500E□□331MK20H
	470	12.5 × 25	0.059	1,150	EGXH500E□□471MK25H
	1,000	16 × 31.5	0.032	1,590	EGXH500E□□102MLN3H

□□ : Enter the appropriate lead forming or taping code.

◆RATED RIPPLE CURRENT MULTIPLIERS

●Frequency Multipliers

Capacitance (μF)	Frequency (Hz)			
	120	1k	10k	100k
100	0.40	0.75	0.90	1.00
220 to 470	0.50	0.85	0.94	1.00
1,000	0.60	0.87	0.95	1.00
2,200 to 3,300	0.75	0.90	0.95	1.00
4,700	0.85	0.95	0.98	1.00

The endurance of capacitors is reduced with internal heating produced by ripple current at the rate of halving the lifetime with every 5°C rise. When long life performance is required in actual use, the rms ripple current has to be reduced.

LBG Series

- For airbag application
- High capacitance, low impedance, and good low temperature behavior
- Endurance with ripple current : 5,000 hours at 105°C
- Solvent resistant type (see PRECAUTIONS AND GUIDELINES)
- RoHS Compliant



◆ SPECIFICATIONS

Items	Characteristics		
Category			
Temperature Range	-55 to +105°C		
Rated Voltage Range	25 & 35V _{dc}		
Capacitance Range	1,000 to 11,000µF (at 20°C, 120Hz)		
Capacitance Tolerance	0 to +30% (A) (at 20°C, 120Hz)		
Leakage Current	I=0.01CV Where, I : Max. leakage current (µA), C : Nominal capacitance (µF), V : Rated voltage (V) (at 20°C after 2 minutes)		
Dissipation Factor (tanδ)	Rated voltage (V _{dc})	25V	35V
	tanδ (Max.)	0.20	0.16
	When nominal capacitance exceeds 1,000µF, add 0.02 to the value above for each 1,000µF increase. (at 20°C, 120Hz)		
Low Temperature Characteristics (Max. Impedance Ratio)	Rated voltage (V _{dc})	25V	35V
	Z(-55°C)/Z(+20°C)	3	3
	Impedance at -40°C and 20°C 100kHz in the STANDARD RATINGS (at 120Hz)		
Endurance	The following specifications shall be satisfied when the capacitors are restored to 20°C after subjected to DC voltage with the rated ripple current is applied (the peak voltage shall not exceed the rated voltage) for 5,000 hours at 105°C.		
	Capacitance change	≤±20% of the initial value	
	D.F. (tanδ)	≤200% of the initial specified value	
	Leakage current	≤The initial specified value	
Shelf Life	The following specifications shall be satisfied when the capacitors are restored to 20°C after exposing them for 1,000 hours at 105°C without voltage applied. Before the measurement, the capacitor shall be preconditioned by applying voltage according to Item 4.1 of JIS C 5101-4.		
	Capacitance change	≤±20% of the initial value	
	D.F. (tanδ)	≤200% of the initial specified value	
	Leakage current	≤The initial specified value	

◆ DIMENSIONS [mm]

● Terminal Code : E

Sleeve (PET : Dark blue)

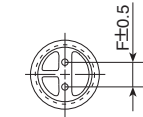
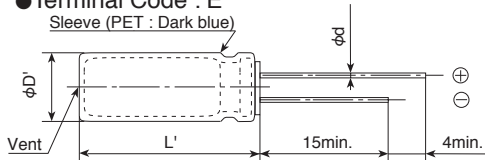

Gas escape end seal

φD	12.5	14.5	16	18
φd	0.6	0.8	0.8	0.8
F	5.0	7.5	7.5	7.5
φD'	φD+0.5max.			
L'	L+1.5max.			

◆ PART NUMBERING SYSTEM

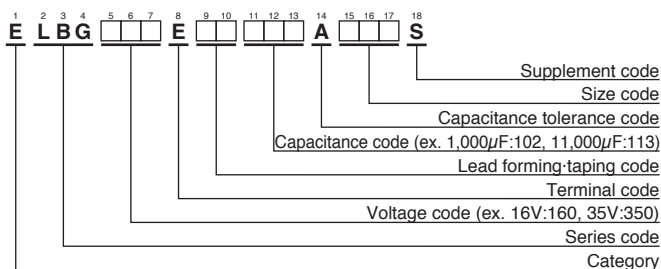

Please refer to "Product code guide (radial lead type)"

◆STANDARD RATINGS

VV (Vdc)	Cap (μF)	Case size φD×L(mm)	Impedance (Ωmax/100kHz)		Rated ripple current (mA _{rms} /105°C,100kHz)	Part No.
			20°C	-40°C		
25	1,700	12.5 × 20	0.057	0.29	1,700	ELBG250E□□172AK20S
	2,400	12.5 × 25	0.045	0.23	2,000	ELBG250E□□242AK25S
	2,400	14.5 × 20	0.051	0.26	2,000	ELBG250E□□242AU20S
	2,800	12.5 × 30	0.039	0.20	2,300	ELBG250E□□282AK30S
	3,000	16 × 20	0.044	0.22	2,250	ELBG250E□□302AL20S
	3,400	14.5 × 25	0.041	0.21	2,400	ELBG250E□□342AU25S
	3,500	12.5 × 35	0.033	0.17	2,700	ELBG250E□□352AK35S
	4,200	16 × 25	0.033	0.17	2,600	ELBG250E□□422AL25S
	4,200	18 × 20	0.042	0.21	2,500	ELBG250E□□422AM20S
	4,500	12.5 × 40	0.027	0.14	3,100	ELBG250E□□452AK40S
	4,600	14.5 × 31.5	0.032	0.16	2,700	ELBG250E□□462AUN3S
	5,400	14.5 × 35.5	0.028	0.14	3,100	ELBG250E□□542AUP1S
	5,600	16 × 31.5	0.026	0.13	3,200	ELBG250E□□562ALN3S
	6,000	18 × 25	0.030	0.15	2,800	ELBG250E□□602AM25S
	6,400	14.5 × 40	0.025	0.13	3,400	ELBG250E□□642AU40S
	6,600	16 × 35.5	0.023	0.12	3,500	ELBG250E□□662ALP1S
	7,800	16 × 40	0.021	0.11	3,800	ELBG250E□□782AL40S
7,900	18 × 31.5	0.024	0.12	3,500	ELBG250E□□792AMN3S	
9,200	18 × 35.5	0.022	0.11	3,700	ELBG250E□□922AMP1S	
11,000	18 × 40	0.020	0.10	4,000	ELBG250E□□113AM40S	
35	1,000	12.5 × 20	0.057	0.29	1,700	ELBG350E□□102AK20S
	1,400	12.5 × 25	0.045	0.23	2,000	ELBG350E□□142AK25S
	1,400	14.5 × 20	0.051	0.26	2,000	ELBG350E□□142AU20S
	1,600	12.5 × 30	0.039	0.20	2,300	ELBG350E□□162AK30S
	1,800	16 × 20	0.044	0.22	2,250	ELBG350E□□182AL20S
	2,000	14.5 × 25	0.041	0.21	2,400	ELBG350E□□202AU25S
	2,100	12.5 × 35	0.033	0.17	2,700	ELBG350E□□212AK35S
	2,500	16 × 25	0.033	0.17	2,600	ELBG350E□□252AL25S
	2,500	18 × 20	0.042	0.21	2,500	ELBG350E□□252AM20S
	2,700	12.5 × 40	0.027	0.14	3,100	ELBG350E□□272AK40S
	2,800	14.5 × 31.5	0.032	0.16	2,700	ELBG350E□□282AUN3S
	3,200	14.5 × 35.5	0.028	0.14	3,100	ELBG350E□□322AUP1S
	3,400	16 × 31.5	0.026	0.13	3,200	ELBG350E□□342ALN3S
	3,600	18 × 25	0.030	0.15	2,800	ELBG350E□□362AM25S
	3,800	14.5 × 40	0.025	0.13	3,400	ELBG350E□□382AU40S
	4,000	16 × 35.5	0.023	0.12	3,500	ELBG350E□□402ALP1S
	4,700	16 × 40	0.021	0.11	3,800	ELBG350E□□472AL40S
4,800	18 × 31.5	0.024	0.12	3,500	ELBG350E□□482AMN3S	
5,600	18 × 35.5	0.022	0.11	3,700	ELBG350E□□562AMP1S	
6,700	18 × 40	0.020	0.10	4,000	ELBG350E□□672AM40S	

□□ : Enter the appropriate lead forming or taping code.

◆RATED RIPPLE CURRENT MULTIPLIERS
●Frequency Multipliers

Capacitance (μF)	Frequency (Hz)			
	120	1k	10k	100k
1,000 to 2,000	0.60	0.87	0.95	1.00
2,100 to 3,800	0.75	0.90	0.95	1.00
4,000 to 11,000	0.85	0.95	0.98	1.00

The endurance of capacitors is reduced with internal heating produced by ripple current at the rate of halving the lifetime with every 5°C rise. When long life performance is required in actual use, the rms ripple current has to be reduced.



◆SPECIFICATIONS

Items	Characteristics						
Category							
Temperature Range	-20 to +65°C						
Rated Voltage Range	300, 315, 330V _{dc}						
Capacitance Tolerance	-10 to +20% (V) (at 20°C, 120Hz)						
Leakage Current	I=1×C Where, I : Max. leakage current (µA), C : Nominal capacitance (µF) (at 20°C after 5 minutes)						
Dissipation Factor (tanδ)	0.06max. (at 20°C, 120Hz)						
Charge and Discharge Characteristics	The following specifications shall be satisfied when the capacitors are restored to 20°C after charge and discharge are repeated 5,000 times at room temperature (5 to 35°C). Discharge resistance or Xenon tube : 0.7 to 1.0Ω. <table border="1"> <tr> <td>Capacitance change</td> <td>≤±10% of the initial value</td> </tr> <tr> <td>D.F. (tanδ)</td> <td>≤150% of the initial specified value</td> </tr> <tr> <td>Leakage current</td> <td>≤150% of the initial specified value</td> </tr> </table>	Capacitance change	≤±10% of the initial value	D.F. (tanδ)	≤150% of the initial specified value	Leakage current	≤150% of the initial specified value
Capacitance change	≤±10% of the initial value						
D.F. (tanδ)	≤150% of the initial specified value						
Leakage current	≤150% of the initial specified value						
Shelf Life	The following specifications shall be satisfied when the capacitors are restored to 20°C after exposing them for 1,000 hours at 65°C without voltage applied. Before the measurement, the capacitor shall be preconditioned by applying voltage according to Item 4.1 of JIS C 5101-4. <table border="1"> <tr> <td>Capacitance change</td> <td>≤±10% of the initial value</td> </tr> <tr> <td>D.F. (tanδ)</td> <td>≤150% of the initial specified value</td> </tr> <tr> <td>Leakage current</td> <td>≤150% of the initial specified value</td> </tr> </table>	Capacitance change	≤±10% of the initial value	D.F. (tanδ)	≤150% of the initial specified value	Leakage current	≤150% of the initial specified value
Capacitance change	≤±10% of the initial value						
D.F. (tanδ)	≤150% of the initial specified value						
Leakage current	≤150% of the initial specified value						

◆DIMENSIONS [mm]

●Terminal Code : E

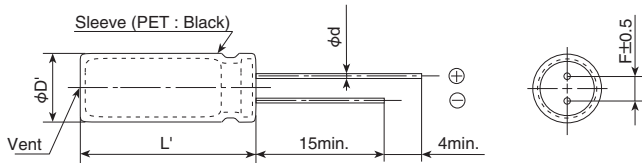

φD	6.0 to 7.5	8.0 to 8.5	9.0 to 9.5	10.0 to 14.0	14.5 to 18.0
φd	0.5	0.6	0.6	0.6	0.8
F	2.5	3.5	4	5	7.5
φD'	φD+0.5max.				
L'	L+1.0max.				

◆PART NUMBERING SYSTEM

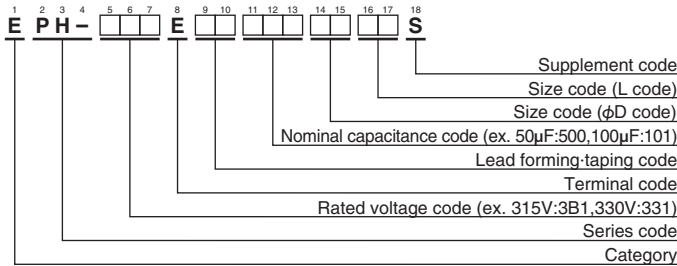

Please refer to "Product code guide (radial lead type)"

●Size Code

φD code (14th, 15th)

φD(mm)	φD code	
	14th	15th
6.0	6	0
6.5	6	5
7.0	7	0
7.5	7	5
8.0	8	0
8.5	8	5
9.0	9	0
9.5	9	5
10.0	A	0
10.5	A	5
11.0	B	0
11.5	B	5
12.0	C	0
12.5	C	5
13.0	D	0
13.5	D	5
14.0	E	0
14.5	E	5
15.0	F	0
15.5	F	5
16.0	G	0
16.5	G	5
17.0	H	0
17.5	H	5
18.0	J	0

L code (16th, 17th)

L(mm)	L code	
	16th	17th
15.0	1	5
16.0	1	6
17.0	1	7
18.0	1	8
19.0	1	9
20.0	2	0
21.0	2	1
22.0	2	2
23.0	2	3
24.0	2	4
25.0	2	5
26.0	2	6
27.0	2	7
28.0	2	8
29.0	2	9
30.0	3	0
31.0	3	1
32.0	3	2
33.0	3	3
34.0	3	4
35.0	3	5
36.0	3	6
37.0	3	7
38.0	3	8
39.0	3	9
40.0	4	0
41.0	4	1
42.0	4	2
43.0	4	3
44.0	4	4
45.0	4	5

◆ RATINGS (REFERENCE)

WV (Vdc)	Cap (μF)	Case size φD×L(mm)	tan δ	Part No.
315	86	10×30	0.06	EPH-3B1E□□860A030S
	122	10×40	0.06	EPH-3B1E□□121A040S
	144	12.5×30	0.06	EPH-3B1E□□1E1C530S
	209	12.5×40	0.06	EPH-3B1E□□211C540S
330	80	10×30	0.06	EPH-331E□□800A030S
	114	10×40	0.06	EPH-331E□□1B1A040S
	137	12.5×30	0.06	EPH-331E□□1D1C530S
	194	12.5×40	0.06	EPH-331E□□1K1C540S

□□ : Enter the appropriate lead forming or taping code.

● Products of vents on the sealing rubber

DIMENSIONS[mm]

<In the case of diameter 10mm>

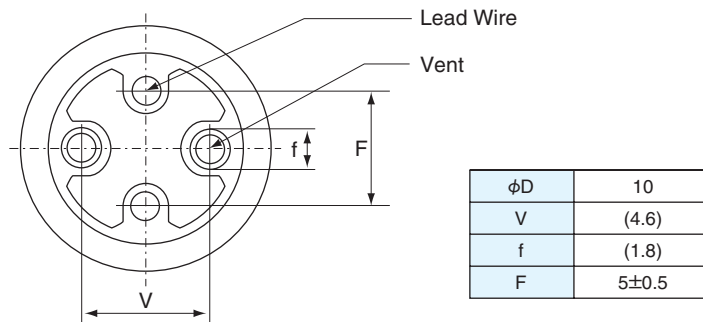

Products of vent on rubber type, please make clearance about 1mm minimum between rubber and board. If it is difficult to make clearance 1mm minimum between rubber and board, please arrange gas escaping hole on the board (same position and 40% minimum diameter from the vent).

The products of dual vents on rubber, requires placement one or two gas escaping hole on the board.

● Products of a vent on the case

Please make the following open space over the vent so that the vent can operate correctly.

Case diameter	Clearance
φ6 to 16mm	2mm minimum
φ16.5mm and up	3mm minimum

Above part numbers are only reference.

Please consult with us about detail specifications (rated voltage, capacitance, case size, type of rubber, etc...).

Snap-in Aluminum Electrolytic Capacitors

(Large Capacitors)



Product code guide (Snap-in type)

(Example : KMM series, 400V-220 μ F, ϕ 30 \times 30L)

Please refer to the following table

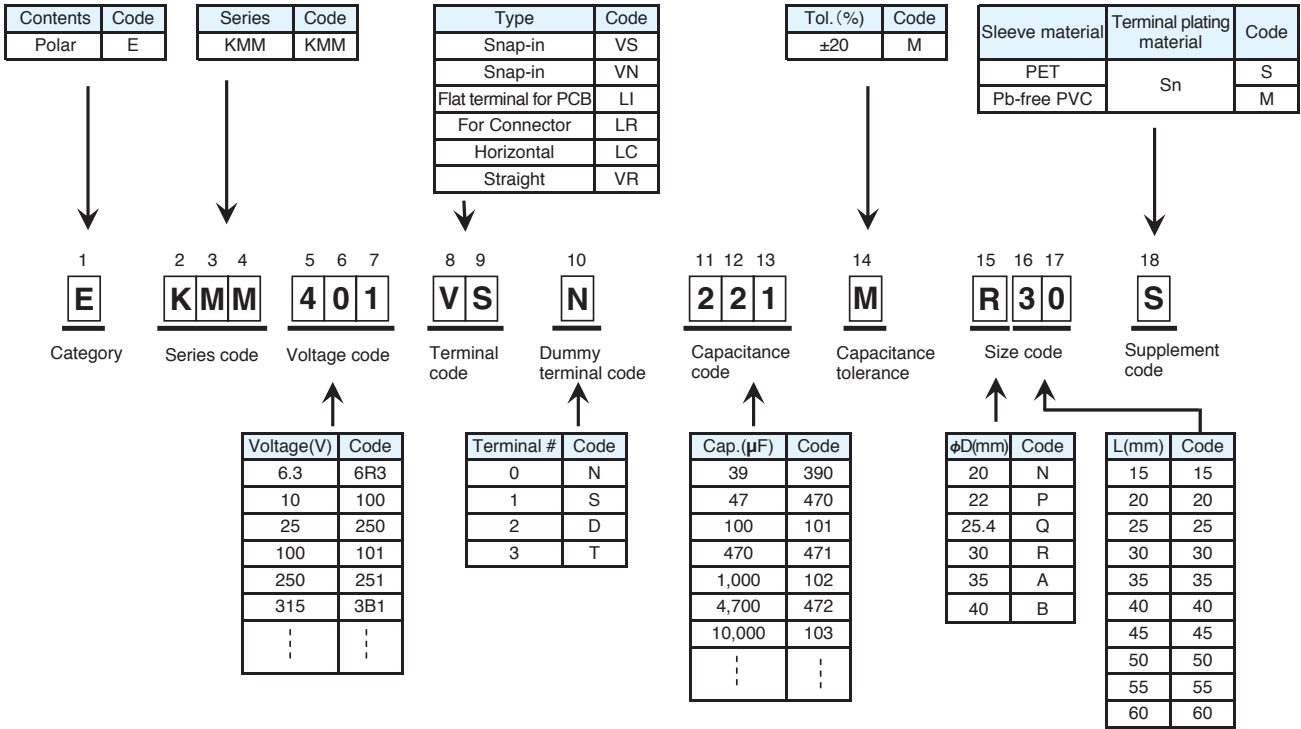

*Refer to the appendix (Part number) for codes not listed here.

SMQ Series

- Endurance with ripple current : 2,000 hours at 85°C
- Non solvent resistant type
- RoHS Compliant

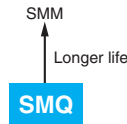

◆SPECIFICATIONS

Items	Characteristics			
Category	-25 to +85°C			
Temperature Range	-25 to +85°C			
Rated Voltage Range	160 to 450V _{dc}			
Capacitance Tolerance	±20% (M) (at 20°C, 120Hz)			
Leakage Current	I ≤ 3√CV Where, I : Max. leakage current (µA), C : Nominal capacitance (µF), V : Rated voltage (V) (at 20°C after 5 minutes)			
Dissipation Factor (tanδ)	Rated voltage (V _{dc})	160 to 250V	315 to 400V	420 & 450V
	tanδ (Max.)	0.15	0.15	0.20
Low Temperature Characteristics (Max. Impedance Ratio)	Rated voltage (V _{dc})	160 to 250V	315 to 400V	420 & 450V
	Z(-25°C)/Z(+20°C)	4	8	8
Endurance	The following specifications shall be satisfied when the capacitors are restored to 20°C after subjected to DC voltage with the rated ripple current is applied (the peak voltage shall not exceed the rated voltage) for 2,000 hours at 85°C.			
	Capacitance change	≤ ±20% of the initial value		
	D. F. (tanδ)	≤ 200% of the initial specified value		
	Leakage current	≤ The initial specified value		
Shelf Life	The following specifications shall be satisfied when the capacitors are restored to 20°C after exposing them for 1,000 hours at 85°C without voltage applied. Before the measurement, the capacitor shall be preconditioned by applying voltage according to Item 4.1 of JIS C 5101-4.			
	Capacitance change	≤ ±15% of the initial value		
	D. F. (tanδ)	≤ 150% of the initial specified value		
	Leakage current	≤ The initial specified value		

◆DIMENSIONS [mm]

●Terminal Code : VS (φ22 to φ35) : Standard

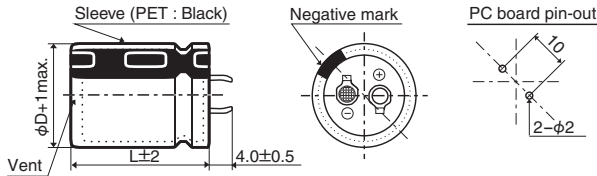

●Terminal Code : LI (φ35)

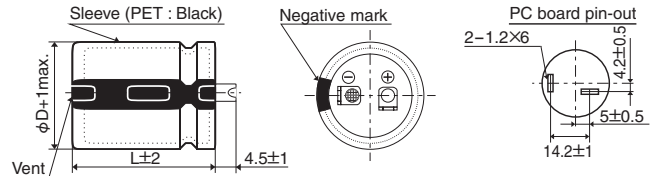

The standard design has no plastic disc.

◆PART NUMBERING SYSTEM

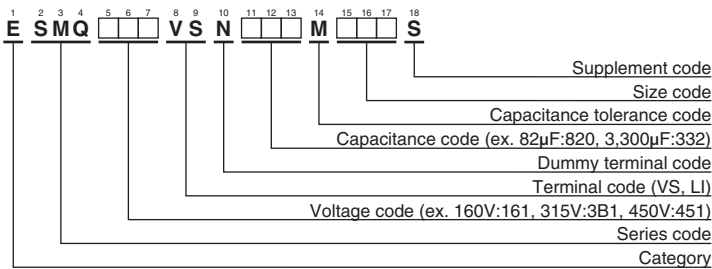

Please refer to "Product code guide (snap-in type)"

◆STANDARD RATINGS

WV (Vdc)	Cap (μF)	Case size φD×L(mm)	tan δ	Rated ripple current (Arms/85°C, 120Hz)	Part No.	WV (Vdc)	Cap (μF)	Case size φD×L(mm)	tan δ	Rated ripple current (Arms/85°C, 120Hz)	Part No.
160	560	22×25	0.15	2.25	ESMQ161VSN561MP25S	250	270	22×25	0.15	1.31	ESMQ251VSN271MP25S
	680	22×30	0.15	2.50	ESMQ161VSN681MP30S		330	22×30	0.15	1.75	ESMQ251VSN331MP30S
	820	22×35	0.15	2.75	ESMQ161VSN821MP35S		390	22×30	0.15	1.91	ESMQ251VSN391MP30S
	1,000	22×40	0.15	3.00	ESMQ161VSN102MP40S		390	25.4×25	0.15	1.91	ESMQ251VSN391MQ25S
	1,000	25.4×30	0.15	3.00	ESMQ161VSN102MQ30S		470	22×35	0.15	2.11	ESMQ251VSN471MP35S
	1,200	22×45	0.15	3.25	ESMQ161VSN122MP45S		470	25.4×30	0.15	2.11	ESMQ251VSN471MQ30S
	1,200	25.4×35	0.15	3.25	ESMQ161VSN122MQ35S		560	22×40	0.15	2.25	ESMQ251VSN561MP40S
	1,200	30×25	0.15	3.25	ESMQ161VSN122MR25S		560	25.4×30	0.15	2.25	ESMQ251VSN561MQ30S
	1,500	22×50	0.15	3.73	ESMQ161VSN152MP50S		560	30×25	0.15	2.25	ESMQ251VSN561MR25S
	1,500	25.4×40	0.15	3.73	ESMQ161VSN152MQ40S		680	22×45	0.15	2.50	ESMQ251VSN681MP45S
	1,500	30×30	0.15	3.73	ESMQ161VSN152MR30S		680	25.4×35	0.15	2.50	ESMQ251VSN681MQ35S
	1,500	35×25	0.15	3.73	ESMQ161VSN152MA25S		680	30×30	0.15	2.50	ESMQ251VSN681MR30S
	1,800	25.4×45	0.15	4.20	ESMQ161VSN182MQ45S		820	22×50	0.15	2.77	ESMQ251VSN821MP50S
	1,800	30×35	0.15	4.20	ESMQ161VSN182MR35S		820	25.4×40	0.15	2.77	ESMQ251VSN821MQ40S
	1,800	35×30	0.15	4.20	ESMQ161VSN182MA30S		820	30×30	0.15	2.77	ESMQ251VSN821MR30S
	2,200	30×40	0.15	4.78	ESMQ161VSN222MR40S		820	35×25	0.15	2.77	ESMQ251VSN821MA25S
	2,200	35×35	0.15	4.78	ESMQ161VSN222MA35S		1,000	25.4×45	0.15	3.32	ESMQ251VSN102MQ45S
	2,700	35×40	0.15	5.45	ESMQ161VSN272MA40S		1,000	30×35	0.15	3.32	ESMQ251VSN102MR35S
	3,300	35×45	0.15	5.75	ESMQ161VSN332MA45S		1,000	35×30	0.15	3.32	ESMQ251VSN102MA30S
	3,900	35×50	0.15	6.00	ESMQ161VSN392MA50S		1,200	30×40	0.15	3.53	ESMQ251VSN122MR40S
180	470	22×25	0.15	2.08	ESMQ181VSN471MP25S	1,200	35×35	0.15	3.53	ESMQ251VSN122MA35S	
	560	22×30	0.15	2.25	ESMQ181VSN561MP30S	1,500	30×50	0.15	4.04	ESMQ251VSN152MR50S	
	680	22×30	0.15	2.50	ESMQ181VSN681MP30S	1,500	35×40	0.15	4.04	ESMQ251VSN152MA40S	
	680	25.4×25	0.15	2.50	ESMQ181VSN681MQ25S	1,800	35×45	0.15	4.55	ESMQ251VSN182MA45S	
	820	22×35	0.15	2.75	ESMQ181VSN821MP35S	180	22×25	0.15	1.21	ESMQ3B1VSN181MP25S	
	820	25.4×30	0.15	2.75	ESMQ181VSN821MQ30S	220	22×30	0.15	1.41	ESMQ3B1VSN221MP30S	
	1,000	22×45	0.15	3.00	ESMQ181VSN102MP45S	270	22×30	0.15	1.60	ESMQ3B1VSN271MP30S	
	1,000	25.4×35	0.15	3.00	ESMQ181VSN102MQ35S	330	22×40	0.15	1.82	ESMQ3B1VSN331MP40S	
	1,000	30×25	0.15	3.00	ESMQ181VSN102MR25S	330	25.4×30	0.15	1.82	ESMQ3B1VSN331MQ30S	
	1,200	22×50	0.15	3.31	ESMQ181VSN122MP50S	330	30×25	0.15	1.82	ESMQ3B1VSN331MR25S	
	1,200	25.4×40	0.15	3.31	ESMQ181VSN122MQ40S	390	22×45	0.15	2.01	ESMQ3B1VSN391MP45S	
	1,200	30×30	0.15	3.31	ESMQ181VSN122MR30S	390	25.4×35	0.15	2.01	ESMQ3B1VSN391MQ35S	
	1,200	35×25	0.15	3.31	ESMQ181VSN122MA25S	390	30×30	0.15	2.01	ESMQ3B1VSN391MR30S	
	1,500	25.4×45	0.15	3.83	ESMQ181VSN152MQ45S	470	22×50	0.15	2.27	ESMQ3B1VSN471MP50S	
	1,500	30×35	0.15	3.83	ESMQ181VSN152MR35S	470	25.4×40	0.15	2.27	ESMQ3B1VSN471MQ40S	
	1,500	35×30	0.15	3.83	ESMQ181VSN152MA30S	470	30×30	0.15	2.27	ESMQ3B1VSN471MR30S	
	1,800	25.4×50	0.15	4.32	ESMQ181VSN182MQ50S	470	35×25	0.15	2.27	ESMQ3B1VSN471MA25S	
	1,800	30×40	0.15	4.32	ESMQ181VSN182MR40S	560	25.4×45	0.15	2.56	ESMQ3B1VSN561MQ45S	
	1,800	35×30	0.15	4.32	ESMQ181VSN182MA30S	560	30×35	0.15	2.56	ESMQ3B1VSN561MR35S	
	2,200	30×45	0.15	4.92	ESMQ181VSN222MR45S	560	35×30	0.15	2.56	ESMQ3B1VSN561MA30S	
2,200	35×40	0.15	4.92	ESMQ181VSN222MA40S	680	30×40	0.15	2.87	ESMQ3B1VSN681MR40S		
2,700	35×45	0.15	5.52	ESMQ181VSN272MA45S	680	35×35	0.15	2.87	ESMQ3B1VSN681MQ35S		
3,300	35×50	0.15	5.75	ESMQ181VSN332MA50S	820	30×45	0.15	3.25	ESMQ3B1VSN821MR45S		
200	390	22×25	0.15	1.68	ESMQ201VSN391MP25S	820	35×40	0.15	3.25	ESMQ3B1VSN821MA40S	
	470	22×30	0.15	1.85	ESMQ201VSN471MP30S	1,000	30×50	0.15	3.63	ESMQ3B1VSN102MR50S	
	560	22×30	0.15	2.43	ESMQ201VSN561MP30S	1,000	35×45	0.15	3.63	ESMQ3B1VSN102MA45S	
	560	25.4×25	0.15	2.43	ESMQ201VSN561MQ25S	150	22×25	0.15	1.12	ESMQ351VSN151MP25S	
	680	22×35	0.15	2.68	ESMQ201VSN681MP35S	180	22×30	0.15	1.22	ESMQ351VSN181MP30S	
	680	25.4×30	0.15	2.68	ESMQ201VSN681MQ30S	220	22×35	0.15	1.44	ESMQ351VSN221MP35S	
	820	22×40	0.15	2.93	ESMQ201VSN821MP40S	270	22×40	0.15	1.66	ESMQ351VSN271MP40S	
	820	25.4×30	0.15	2.93	ESMQ201VSN821MQ30S	270	25.4×30	0.15	1.66	ESMQ351VSN271MQ30S	
	820	30×25	0.15	2.93	ESMQ201VSN821MR25S	330	22×45	0.15	1.88	ESMQ351VSN331MP45S	
	1,000	22×45	0.15	3.25	ESMQ201VSN102MP45S	330	25.4×35	0.15	1.88	ESMQ351VSN331MQ35S	
	1,000	25.4×35	0.15	3.25	ESMQ201VSN102MQ35S	390	22×50	0.15	2.06	ESMQ351VSN391MP50S	
	1,000	30×30	0.15	3.25	ESMQ201VSN102MR30S	390	25.4×40	0.15	2.06	ESMQ351VSN391MQ40S	
	1,000	35×25	0.15	3.25	ESMQ201VSN102MA25S	390	30×30	0.15	2.06	ESMQ351VSN391MR30S	
	1,200	25.4×40	0.15	3.50	ESMQ201VSN122MQ40S	390	35×25	0.15	2.06	ESMQ351VSN391MA25S	
	1,200	30×30	0.15	3.50	ESMQ201VSN122MR30S	470	25.4×45	0.15	2.40	ESMQ351VSN471MQ45S	
	1,200	35×30	0.15	3.50	ESMQ201VSN122MA30S	470	30×35	0.15	2.40	ESMQ351VSN471MR35S	
	1,500	25.4×50	0.15	3.87	ESMQ201VSN152MQ50S	470	35×30	0.15	2.40	ESMQ351VSN471MA30S	
	1,500	30×35	0.15	3.87	ESMQ201VSN152MR35S	560	25.4×50	0.15	2.60	ESMQ351VSN561MQ50S	
	1,500	35×30	0.15	3.87	ESMQ201VSN152MA30S	560	30×40	0.15	2.60	ESMQ351VSN561MR40S	
	1,800	30×45	0.15	4.32	ESMQ201VSN182MR45S	560	35×30	0.15	2.60	ESMQ351VSN561MA30S	
1,800	35×35	0.15	4.32	ESMQ201VSN182MA35S	680	30×45	0.15	2.96	ESMQ351VSN681MR45S		
2,200	30×50	0.15	4.92	ESMQ201VSN222MR50S	680	35×35	0.15	2.96	ESMQ351VSN681MA35S		
2,200	35×40	0.15	4.92	ESMQ201VSN222MA40S	820	30×50	0.15	3.25	ESMQ351VSN821MR50S		
2,700	35×50	0.15	5.45	ESMQ201VSN272MA50S	820	35×45	0.15	3.25	ESMQ351VSN821MA45S		

◆STANDARD RATINGS

WV (V _{dc})	Cap (μF)	Case size φD×L(mm)	tan δ	Rated ripple current (Arms/85°C,120Hz)	Part No.	WV (V _{dc})	Cap (μF)	Case size φD×L(mm)	tan δ	Rated ripple current (Arms/85°C,120Hz)	Part No.	
350	1,000	35×50	0.15	3.54	ESMQ351VSN102MA50S	420	270	30×30	0.20	1.94	ESMQ421VSN271MR30S	
	120	22×25	0.15	1.02	ESMQ401VSN121MP25S		330	25.4×45	0.20	2.17	ESMQ421VSN331MQ45S	
	150	22×30	0.15	1.16	ESMQ401VSN151MP30S		330	30×35	0.20	2.17	ESMQ421VSN331MR35S	
	180	22×35	0.15	1.44	ESMQ401VSN181MP35S		330	35×30	0.20	2.17	ESMQ421VSN331MA30S	
	220	22×40	0.15	1.49	ESMQ401VSN221MP40S		390	25.4×50	0.20	2.27	ESMQ421VSN391MQ50S	
	220	25.4×30	0.15	1.49	ESMQ401VSN221MQ30S		390	30×35	0.20	2.27	ESMQ421VSN391MR35S	
	270	22×45	0.15	1.67	ESMQ401VSN271MP45S		390	35×30	0.20	2.27	ESMQ421VSN391MA30S	
	270	25.4×35	0.15	1.67	ESMQ401VSN271MQ35S		470	30×40	0.20	2.61	ESMQ421VSN471MR40S	
	270	30×25	0.15	1.67	ESMQ401VSN271MP25S		470	35×35	0.20	2.61	ESMQ421VSN471MA35S	
	330	22×50	0.15	1.90	ESMQ401VSN331MP50S		560	30×50	0.20	2.82	ESMQ421VSN561MR50S	
	330	25.4×40	0.15	1.90	ESMQ401VSN331MQ40S		560	35×40	0.20	2.82	ESMQ421VSN561MA40S	
	330	30×30	0.15	1.90	ESMQ401VSN331MR30S		680	35×45	0.20	3.11	ESMQ421VSN681MA45S	
	330	35×25	0.15	1.90	ESMQ401VSN331MA25S		450	82	22×25	0.20	0.83	ESMQ451VSN820MP25S
	390	25.4×45	0.15	2.13	ESMQ401VSN391MQ45S			100	22×25	0.20	0.93	ESMQ451VSN101MP25S
	390	30×35	0.15	2.13	ESMQ401VSN391MR35S			120	22×30	0.20	1.04	ESMQ451VSN121MP30S
	390	35×30	0.15	2.13	ESMQ401VSN391MA30S			150	22×35	0.20	1.19	ESMQ451VSN151MP35S
	470	25.4×50	0.15	2.39	ESMQ401VSN471MQ50S			150	25.4×25	0.20	1.19	ESMQ451VSN151MQ25S
470	30×40	0.15	2.39	ESMQ401VSN471MR40S	180	22×40		0.20	1.35	ESMQ451VSN181MP40S		
470	35×30	0.15	2.39	ESMQ401VSN471MA30S	180	25.4×30		0.20	1.35	ESMQ451VSN181MQ30S		
560	30×45	0.15	2.69	ESMQ401VSN561MR45S	220	22×45		0.20	1.55	ESMQ451VSN221MP45S		
560	35×35	0.15	2.69	ESMQ401VSN561MA35S	220	25.4×40		0.20	1.55	ESMQ451VSN221MQ40S		
680	30×50	0.15	2.96	ESMQ401VSN681MR50S	220	30×30		0.20	1.55	ESMQ451VSN221MR30S		
680	35×40	0.15	2.96	ESMQ401VSN681MA40S	220	35×25		0.20	1.55	ESMQ451VSN221MA25S		
820	35×45	0.15	3.25	ESMQ401VSN821MA45S	270	22×50		0.20	1.78	ESMQ451VSN271MP50S		
400	100	22×25	0.20	0.97	ESMQ421VSN101MP25S	270		25.4×40	0.20	1.78	ESMQ451VSN271MQ40S	
	120	22×25	0.20	1.08	ESMQ421VSN121MP25S	270		30×30	0.20	1.78	ESMQ451VSN271MR30S	
	150	22×30	0.20	1.30	ESMQ421VSN151MP30S	330		25.4×50	0.20	2.01	ESMQ451VSN331MQ50S	
	150	25.4×25	0.20	1.30	ESMQ421VSN151MQ25S	330		30×40	0.20	2.01	ESMQ451VSN331MR40S	
	180	22×35	0.20	1.48	ESMQ421VSN181MP35S	330		35×30	0.20	2.01	ESMQ451VSN331MA30S	
	180	25.4×30	0.20	1.48	ESMQ421VSN181MQ30S	390	30×40	0.20	2.24	ESMQ451VSN391MR40S		
	220	22×40	0.20	1.65	ESMQ421VSN221MP40S	390	35×35	0.20	2.24	ESMQ451VSN391MA35S		
	220	25.4×35	0.20	1.65	ESMQ421VSN221MQ35S	470	30×45	0.20	2.53	ESMQ451VSN471MR45S		
	220	30×25	0.20	1.65	ESMQ421VSN221MR25S	470	35×40	0.20	2.53	ESMQ451VSN471MA40S		
	270	22×50	0.20	1.94	ESMQ421VSN271MP50S	560	30×50	0.20	2.82	ESMQ451VSN561MR50S		
	270	25.4×35	0.20	1.94	ESMQ421VSN271MQ35S	560	35×45	0.20	2.82	ESMQ451VSN561MA45S		

◆RATED RIPPLE CURRENT MULTIPLIERS

●Frequency Multipliers

Frequency(Hz)	50	120	300	1k	10k	50k
160 to 250V _{dc}	0.81	1.00	1.17	1.32	1.45	1.50
315 to 450V _{dc}	0.77	1.00	1.16	1.30	1.41	1.43

The endurance of capacitors is reduced with internal heating produced by ripple current at the rate of halving the lifetime with every 5°C rise. When long life performance is required in actual use, the rms ripple current has to be reduced.

New!

KMW Series

- Downsized from KMR series
- Endurance with ripple current : 2,000 hours at 105°C
- Rated voltage range : 400 to 450V_{dc}, Capacitance range : 120 to 1,000μF
- Non solvent resistant type
- RoHS Compliant

KMW

↓
Downsized

KMR



◆ SPECIFICATIONS

Items	Characteristics		
Category	-25 to +105°C		
Temperature Range	-25 to +105°C		
Rated Voltage Range	160 to 450V _{dc}		
Capacitance Tolerance	±20% (M) (at 20°C, 120Hz)		
Leakage Current	I ≤ 3√CV Where, I : Max. leakage current (μA), C : Nominal capacitance (μF), V : Rated voltage (V) (at 20°C after 5 minutes)		
Dissipation Factor (tanδ)	Rated voltage (V _{dc})	400V	420 & 450V
	tanδ (Max.)	0.15	0.20
Low Temperature Characteristics (Max. Impedance Ratio)	Rated voltage (V _{dc})	400 to 450V	
	Z(-25°C)/Z(+20°C)	8	
Endurance	The following specifications shall be satisfied when the capacitors are restored to 20°C after subjected to DC voltage with the rated ripple current is applied (the peak voltage shall not exceed the rated voltage) for 2,000 hours at 105°C.		
	Capacitance change	≤ ±20% of the initial value	
	D.F. (tanδ)	≤ 200% of the initial specified value	
	Leakage current	≤ The initial specified value	
Shelf Life	The following specifications shall be satisfied when the capacitors are restored to 20°C after exposing them for 1,000 hours at 105°C without voltage applied. Before the measurement, the capacitor shall be preconditioned by applying voltage according to Item 4.1 of JIS C 5101-4.		
	Capacitance change	≤ ±15% of the initial value	
	D.F. (tanδ)	≤ 150% of the initial specified value	
	Leakage current	≤ The initial specified value	

◆ DIMENSIONS [mm]

● Terminal Code : VS (φ22 to φ35) : Standard

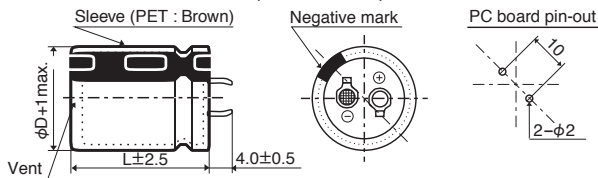

● Terminal Code : LI (φ35)

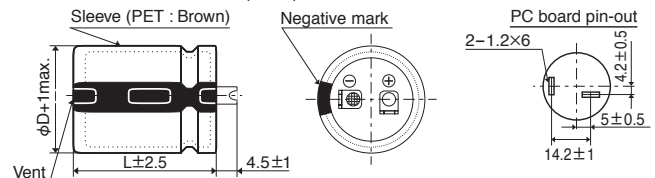

The standard design has no plastic disc.

◆ PART NUMBERING SYSTEM

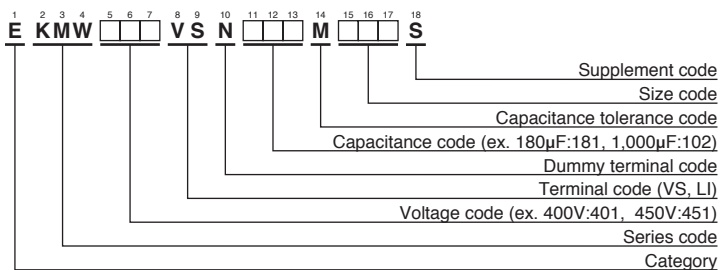

Please refer to "Product code guide (snap-in type)"

New!

KMW Series

◆STANDARD RATINGS

WV (Vdc)	Cap (μF)	Case size φD×L(mm)	tan δ	Rated ripple current (Arms/105°C,120Hz)	Part No.	WV (Vdc)	Cap (μF)	Case size φD×L(mm)	tan δ	Rated ripple current (Arms/105°C,120Hz)	Part No.
400	150	22×25	0.15	0.91	EKMW401VSN151MP25S	420	330	35×25	0.20	1.38	EKMW421VSN331MA25S
	180	22×30	0.15	1.04	EKMW401VSN181MP30S		390	25.4×45	0.20	1.67	EKMW421VSN391MQ45S
	220	22×35	0.15	1.18	EKMW401VSN221MP35S		390	25.4×50	0.20	1.70	EKMW421VSN391MQ50S
	220	25.4×25	0.15	1.15	EKMW401VSN221MQ25S		390	30×35	0.20	1.59	EKMW421VSN391MR35S
	270	25.4×30	0.15	1.31	EKMW401VSN271MQ30S		470	30×40	0.20	1.79	EKMW421VSN471MR40S
	330	22×45	0.15	1.50	EKMW401VSN331MP45S		470	35×30	0.20	1.67	EKMW421VSN471MA30S
	330	25.4×30	0.15	1.51	EKMW401VSN331MR35S		560	30×45	0.20	2.01	EKMW421VSN561MR45S
	330	30×25	0.15	1.46	EKMW401VSN331MR25S		560	35×35	0.20	1.85	EKMW421VSN561MA35S
	390	22×50	0.15	1.67	EKMW401VSN391MP50S		680	35×40	0.20	2.11	EKMW421VSN681MA40S
	390	25.4×40	0.15	1.67	EKMW401VSN391MQ40S		450	120	22×25	0.20	0.78
	390	30×30	0.15	1.61	EKMW401VSN391MR30S	150		22×30	0.20	0.91	EKMW451VSN151MP30S
	390	35×25	0.15	1.40	EKMW401VSN391MA25S	150		25.4×25	0.20	0.93	EKMW451VSN151MQ25S
	470	25.4×45	0.15	1.87	EKMW401VSN471MQ45S	180		22×35	0.20	1.02	EKMW451VSN181MP35S
	470	30×35	0.15	1.81	EKMW401VSN471MR35S	180		25.4×30	0.20	1.05	EKMW451VSN181MQ30S
	560	30×40	0.15	2.03	EKMW401VSN561MR40S	220		22×40	0.20	1.15	EKMW451VSN221MR40S
	560	35×30	0.15	1.70	EKMW401VSN561MA30S	220		25.4×35	0.20	1.21	EKMW451VSN221MQ35S
	680	30×45	0.15	2.29	EKMW401VSN681MR45S	220		30×25	0.20	1.15	EKMW451VSN221MR25S
	680	30×50	0.15	2.33	EKMW401VSN681MR50S	270		22×50	0.20	1.36	EKMW451VSN271MP50S
	680	35×35	0.15	1.90	EKMW401VSN681MA35S	270		25.4×40	0.20	1.36	EKMW451VSN271MQ40S
	820	35×40	0.15	2.16	EKMW401VSN821MA40S	270	30×30	0.20	1.29	EKMW451VSN271MR30S	
1,000	35×50	0.15	2.50	EKMW401VSN102MA50S	330	25.4×45	0.20	1.54	EKMW451VSN331MQ45S		
420	120	22×25	0.20	0.78	EKMW421VSN121MP25S	330	30×35	0.20	1.46	EKMW451VSN331MR35S	
	150	22×30	0.20	0.91	EKMW421VSN151MP30S	390	25.4×50	0.20	1.70	EKMW451VSN391MQ50S	
	180	25.4×25	0.20	1.02	EKMW421VSN181MQ25S	390	30×40	0.20	1.63	EKMW451VSN391MR40S	
	220	25.4×30	0.20	1.16	EKMW421VSN221MQ30S	390	35×30	0.20	1.52	EKMW451VSN391MA30S	
	270	22×45	0.20	1.30	EKMW421VSN271MP45S	470	30×45	0.20	1.85	EKMW451VSN471MR45S	
	270	25.4×35	0.20	1.34	EKMW421VSN271MQ35S	470	35×35	0.20	1.77	EKMW451VSN471MA35S	
	270	30×25	0.20	1.28	EKMW421VSN271MR25S	560	30×50	0.20	2.04	EKMW451VSN561MR50S	
	330	22×50	0.20	1.47	EKMW421VSN331MP50S	560	35×40	0.20	2.02	EKMW451VSN561MA40S	
	330	25.4×40	0.20	1.51	EKMW421VSN331MQ40S	680	35×45	0.20	2.16	EKMW451VSN681MA45S	
	330	30×30	0.20	1.43	EKMW421VSN331MR30S	820	35×50	0.20	2.42	EKMW451VSN821MA50S	

◆RATED RIPPLE CURRENT MULTIPLIERS

●Frequency Multipliers

Frequency(Hz)	50	120	300	1k	10k	50k
400 to 450V _{dc}	0.77	1.00	1.16	1.30	1.41	1.43

The endurance of capacitors is reduced with internal heating produced by ripple current at the rate of halving the lifetime with every 5°C rise. When long life performance is required in actual use, the rms ripple current has to be reduced.

KMR Series

- Downsized 5mm in height from current snap-ins KMQ series
- Max. 50% up ripple current than same case size of KMQ series
- Endurance with ripple current : 2,000 hours at 105°C
- Rated voltage range : 160 to 450V_{dc}, Capacitance range : 100 to 3,300μF
- For inverter control, switching power supplies
- Non solvent resistant type
- RoHS Compliant

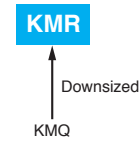

◆ SPECIFICATIONS

Items	Characteristics			
Category	-25 to +105°C			
Temperature Range				
Rated Voltage Range	160 to 450V _{dc}			
Capacitance Tolerance	±20% (M) (at 20°C, 120Hz)			
Leakage Current	I ≤ 3√CV Where, I : Max. leakage current (μA), C : Nominal capacitance (μF), V : Rated voltage (V) (at 20°C after 5 minutes)			
Dissipation Factor (tanδ)	Rated voltage (V _{dc})	160 to 250V	315 to 400V	420 & 450V
	tanδ (Max.)	0.15	0.15	0.20
		(at 20°C, 120Hz)		
Low Temperature Characteristics (Max. Impedance Ratio)	Rated voltage (V _{dc})	160 to 250V	315 to 400V	420 & 450V
	Z(-25°C)/Z(+20°C)	4	8	8
		(at 120Hz)		
Endurance	The following specifications shall be satisfied when the capacitors are restored to 20°C after subjected to DC voltage with the rated ripple current is applied (the peak voltage shall not exceed the rated voltage) for 2,000 hours at 105°C.			
	Capacitance change	≤ ±20% of the initial value		
	D.F. (tanδ)	≤ 200% of the initial specified value		
	Leakage current	≤ The initial specified value		
Shelf Life	The following specifications shall be satisfied when the capacitors are restored to 20°C after exposing them for 1,000 hours at 105°C without voltage applied. Before the measurement, the capacitor shall be preconditioned by applying voltage according to Item 4.1 of JIS C 5101-4.			
	Capacitance change	≤ ±15% of the initial value		
	D.F. (tanδ)	≤ 150% of the initial specified value		
	Leakage current	≤ The initial specified value		

◆ DIMENSIONS [mm]

● Terminal Code : VS (φ22 to φ35) : Standard

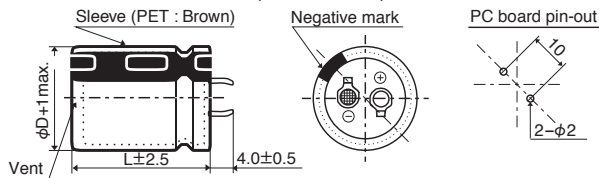

● Terminal Code : LI (φ35)

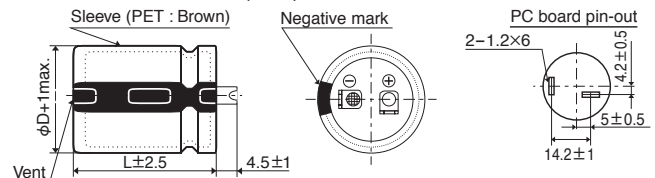

The standard design has no plastic disc.

◆ PART NUMBERING SYSTEM

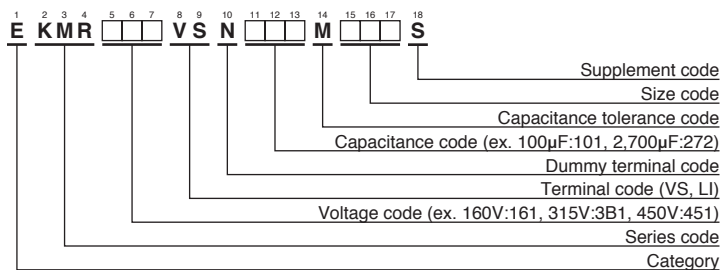

Please refer to "Product code guide (snap-in type)"



◆STANDARD RATINGS

WV (Vdc)	Cap (μF)	Case size φD×L(mm)	Rated ripple current (Arms/105°C,120Hz)	Part No.	WV (Vdc)	Cap (μF)	Case size φD×L(mm)	Rated ripple current (Arms/105°C,120Hz)	Part No.
160	560	22×25	1.58	EKMR161VSN561MP25S	250	330	22×25	1.21	EKMR251VSN331MP25S
	680	22×30	1.83	EKMR161VSN681MP30S		390	22×30	1.38	EKMR251VSN391MP30S
	820	22×35	2.06	EKMR161VSN821MP35S		470	22×35	1.56	EKMR251VSN471MP35S
	820	25.4×25	1.89	EKMR161VSN821MQ25S		560	22×40	1.74	EKMR251VSN561MP40S
	1,000	22×40	2.33	EKMR161VSN102MP40S		560	25.4×30	1.61	EKMR251VSN561MQ30S
	1,000	25.4×30	2.15	EKMR161VSN102MQ30S		560	30×25	1.42	EKMR251VSN561MR25S
	1,000	30×25	1.90	EKMR161VSN102MR25S		680	22×45	1.97	EKMR251VSN681MP45S
	1,200	22×45	2.61	EKMR161VSN122MP45S		680	25.4×35	1.85	EKMR251VSN681MQ35S
	1,200	22×50	2.69	EKMR161VSN122MP50S		820	25.4×40	2.08	EKMR251VSN821MQ40S
	1,200	25.4×35	2.45	EKMR161VSN122MQ35S		820	25.4×45	2.13	EKMR251VSN821MQ45S
	1,500	25.4×40	2.82	EKMR161VSN152MQ40S		820	30×30	1.77	EKMR251VSN821MP30S
	1,500	25.4×45	2.88	EKMR161VSN152MQ45S		820	35×25	1.60	EKMR251VSN821MA25S
	1,500	30×30	2.39	EKMR161VSN152MR30S		1,000	25.4×50	2.40	EKMR251VSN102MQ50S
	1,500	35×25	2.17	EKMR161VSN152MA25S		1,000	30×35	2.03	EKMR251VSN102MR35S
	1,800	25.4×50	3.22	EKMR161VSN182MQ50S		1,200	30×40	2.31	EKMR251VSN122MR40S
	1,800	30×35	2.73	EKMR161VSN182MR35S		1,200	30×45	2.38	EKMR251VSN122MR45S
	1,800	30×40	2.82	EKMR161VSN182MR40S		1,200	35×35	2.06	EKMR251VSN122MA35S
	1,800	35×30	2.47	EKMR161VSN182MA30S		1,500	30×50	2.73	EKMR251VSN152MR50S
	2,200	30×45	3.23	EKMR161VSN222MR45S		1,500	35×40	2.41	EKMR251VSN152MA40S
	2,200	35×35	2.79	EKMR161VSN222MA35S		1,800	35×45	2.72	EKMR251VSN182MA45S
2,700	30×50	3.66	EKMR161VSN272MR50S	2,200	35×50	3.10	EKMR251VSN222MA50S		
2,700	35×40	3.23	EKMR161VSN272MA40S	315	180	22×25	0.91	EKMR3B1VSN181MP25S	
3,300	35×45	3.68	EKMR161VSN332MA45S		220	22×30	1.06	EKMR3B1VSN221MP30S	
180	470	22×25	1.45		EKMR181VSN471MP25S	270	22×35	1.20	EKMR3B1VSN271MP35S
	560	22×30	1.66		EKMR181VSN561MP30S	270	25.4×25	1.15	EKMR3B1VSN271MQ25S
	680	22×35	1.87		EKMR181VSN681MP35S	330	22×40	1.37	EKMR3B1VSN331MP40S
	680	25.4×25	1.72		EKMR181VSN681MQ25S	330	25.4×30	1.30	EKMR3B1VSN331MQ30S
	820	22×40	2.11		EKMR181VSN821MP40S	390	22×45	1.52	EKMR3B1VSN391MP45S
	820	25.4×30	1.94		EKMR181VSN821MQ30S	390	25.4×35	1.48	EKMR3B1VSN391MQ35S
	1,000	22×45	2.38		EKMR181VSN102MP45S	390	30×25	1.39	EKMR3B1VSN391MR25S
	1,000	25.4×35	2.24		EKMR181VSN102MQ35S	470	22×50	1.72	EKMR3B1VSN471MP50S
	1,000	30×25	1.90		EKMR181VSN102MR25S	470	25.4×40	1.67	EKMR3B1VSN471MQ40S
	1,200	22×50	2.69		EKMR181VSN122MP50S	470	30×30	1.57	EKMR3B1VSN471MR30S
	1,200	25.4×40	2.52		EKMR181VSN122MQ40S	470	35×25	1.52	EKMR3B1VSN471MA25S
	1,200	30×30	2.14		EKMR181VSN122MR30S	560	25.4×45	1.86	EKMR3B1VSN561MQ45S
	1,200	35×25	1.94		EKMR181VSN122MA25S	560	30×35	1.78	EKMR3B1VSN561MP35S
	1,500	25.4×45	2.88		EKMR181VSN152MQ45S	680	25.4×50	2.10	EKMR3B1VSN681MQ50S
	1,500	25.4×50	2.94		EKMR181VSN152MQ50S	680	30×40	2.03	EKMR3B1VSN681MR40S
	1,500	30×35	2.49		EKMR181VSN152MR35S	680	35×30	1.90	EKMR3B1VSN681MA30S
	1,800	30×40	2.82		EKMR181VSN182MR40S	820	30×45	2.31	EKMR3B1VSN821MR45S
	1,800	35×30	2.47		EKMR181VSN182MA30S	820	35×35	2.13	EKMR3B1VSN821MA35S
	2,200	30×45	3.23	EKMR181VSN222MR45S	1,000	30×50	2.61	EKMR3B1VSN102MR50S	
	2,200	30×50	3.31	EKMR181VSN222MR50S	1,000	35×40	2.46	EKMR3B1VSN102MA40S	
2,200	35×35	2.79	EKMR181VSN222MA35S	1,200	35×45	2.78	EKMR3B1VSN122MA45S		
2,200	35×40	2.92	EKMR181VSN222MA40S	1,200	35×50	2.86	EKMR3B1VSN122MA50S		
2,700	35×45	3.33	EKMR181VSN272MA45S	350	150	22×25	0.84	EKMR351VSN151MP25S	
200	560	22×30	1.66		EKMR201VSN561MP30S	220	22×30	1.06	EKMR351VSN221MP30S
	560	25.4×25	1.56		EKMR201VSN561MQ25S	220	25.4×25	1.04	EKMR351VSN221MQ25S
	680	22×35	1.87		EKMR201VSN681MP35S	270	22×35	1.20	EKMR351VSN271MP35S
	680	25.4×30	1.77		EKMR201VSN681MQ30S	270	25.4×30	1.18	EKMR351VSN271MQ30S
	820	22×40	2.11		EKMR201VSN821MP40S	330	22×40	1.37	EKMR351VSN331MP40S
	820	25.4×35	2.03		EKMR201VSN821MQ35S	330	22×45	1.40	EKMR351VSN331MP45S
	820	30×25	1.72		EKMR201VSN821MR25S	330	25.4×35	1.36	EKMR351VSN331MQ35S
	1,000	22×50	2.45		EKMR201VSN102MP50S	330	30×25	1.28	EKMR351VSN331MR25S
	1,000	25.4×40	2.30		EKMR201VSN102MQ40S	390	22×50	1.56	EKMR351VSN391MP50S
	1,000	30×30	1.95		EKMR201VSN102MR30S	390	25.4×40	1.52	EKMR351VSN391MQ40S
	1,200	25.4×45	2.58		EKMR201VSN122MQ45S	390	30×30	1.43	EKMR351VSN391MR30S
	1,200	30×35	2.23		EKMR201VSN122MR35S	390	35×25	1.38	EKMR351VSN391MA25S
	1,200	35×25	1.94		EKMR201VSN122MA25S	470	25.4×45	1.71	EKMR351VSN471MQ45S
	1,500	25.4×50	2.94		EKMR201VSN152MQ50S	560	25.4×50	1.90	EKMR351VSN561MQ50S
	1,500	30×40	2.58		EKMR201VSN152MR40S	560	30×35	1.78	EKMR351VSN561MR35S
	1,500	35×30	2.25		EKMR201VSN152MA30S	560	30×40	1.84	EKMR351VSN561MR40S
	1,800	30×45	2.92		EKMR201VSN182MR45S	560	35×30	1.72	EKMR351VSN561MA30S
	1,800	35×35	2.53		EKMR201VSN182MA35S	680	30×45	2.10	EKMR351VSN681MR45S
	2,200	30×50	3.31		EKMR201VSN222MR50S	680	35×35	1.94	EKMR351VSN681MA35S
	2,200	35×40	2.92	EKMR201VSN222MA40S	820	30×50	2.36	EKMR351VSN821MR50S	
2,700	35×45	3.33	EKMR201VSN272MA45S						

◆STANDARD RATINGS

WV (V _{dc})	Cap (μF)	Case size φD×L(mm)	Rated ripple current (Arms/105°C, 120Hz)	Part No.	WV (V _{dc})	Cap (μF)	Case size φD×L(mm)	Rated ripple current (Arms/105°C, 120Hz)	Part No.	
350	820	35×40	2.23	EKMR351VSN821MA40S	420	270	25.4×40	1.32	EKMR421VSN271MQ40S	
	1,000	35×45	2.54	EKMR351VSN102MA45S		270	30×30	1.26	EKMR421VSN271MR30S	
	1,200	35×50	2.86	EKMR351VSN122MA50S		270	35×25	1.26	EKMR421VSN271MA25S	
400	120	22×25	0.75	EKMR401VSN121MP25S		330	25.4×45	1.49	EKMR421VSN331MQ45S	
	180	22×30	0.96	EKMR401VSN181MP30S		330	30×35	1.45	EKMR421VSN331MR35S	
	180	25.4×25	0.94	EKMR401VSN181MQ25S		390	25.4×50	1.66	EKMR421VSN391MQ50S	
	220	22×35	1.09	EKMR401VSN221MP35S		390	30×40	1.63	EKMR421VSN391MR40S	
	220	25.4×30	1.07	EKMR401VSN221MQ30S		390	35×30	1.58	EKMR421VSN391MA30S	
	270	22×40	1.24	EKMR401VSN271MP40S		470	30×45	1.85	EKMR421VSN471MR45S	
	270	22×45	1.26	EKMR401VSN271MP45S		470	35×35	1.77	EKMR421VSN471MA35S	
	270	25.4×35	1.23	EKMR401VSN271MQ35S		560	30×50	2.07	EKMR421VSN561MR50S	
	270	30×25	1.16	EKMR401VSN271MR25S		560	35×40	2.02	EKMR421VSN561MA40S	
	330	22×50	1.44	EKMR401VSN331MP50S		680	35×45	2.29	EKMR421VSN681MA45S	
	330	25.4×40	1.40	EKMR401VSN331MQ40S		820	35×50	2.59	EKMR421VSN821MA50S	
	330	30×30	1.31	EKMR401VSN331MR30S		450	100	22×25	0.71	EKMR451VSN101MP25S
	330	35×25	1.27	EKMR401VSN331MA25S			120	22×30	0.82	EKMR451VSN121MP30S
	390	25.4×45	1.55	EKMR401VSN391MQ45S			150	22×35	0.94	EKMR451VSN151MP35S
	390	30×35	1.49	EKMR401VSN391MR35S			150	25.4×25	0.89	EKMR451VSN151MQ25S
	470	25.4×50	1.74	EKMR401VSN471MQ50S	180		22×40	1.05	EKMR451VSN181MP40S	
	470	30×40	1.69	EKMR401VSN471MR40S	180		25.4×30	1.00	EKMR451VSN181MQ30S	
	470	35×30	1.58	EKMR401VSN471MA30S	220		22×45	1.19	EKMR451VSN221MP45S	
	560	30×45	1.91	EKMR401VSN561MR45S	220		25.4×35	1.16	EKMR451VSN221MQ35S	
	560	35×35	1.76	EKMR401VSN561MA35S	220		30×25	1.11	EKMR451VSN221MR25S	
	680	30×50	2.15	EKMR401VSN681MR50S	270		22×50	1.36	EKMR451VSN271MP50S	
	680	35×40	2.03	EKMR401VSN681MA40S	270		25.4×40	1.32	EKMR451VSN271MQ40S	
	820	35×45	2.30	EKMR401VSN821MA45S	270		25.4×45	1.35	EKMR451VSN271MQ45S	
	820	35×50	2.37	EKMR401VSN821MA50S	270		30×30	1.26	EKMR451VSN271MR30S	
	1,000	35×50	2.50	EKMR401VSN102MA50S	270		35×25	1.26	EKMR451VSN271MA25S	
	420	120	35×50	0.78	EKMR421VSN121MP25S		330	25.4×50	1.52	EKMR451VSN331MQ50S
		150	22×30	0.91	EKMR421VSN151MP30S		330	30×35	1.45	EKMR451VSN331MR35S
150		25.4×25	0.89	EKMR421VSN151MQ25S	330		35×30	1.45	EKMR451VSN331MA30S	
180		22×35	1.03	EKMR421VSN181MP35S	390		30×40	1.63	EKMR451VSN391MR40S	
180		25.4×30	1.00	EKMR421VSN181MQ30S	470	30×45	1.85	EKMR451VSN471MR45S		
220		22×40	1.16	EKMR421VSN221MP40S	470	30×50	1.90	EKMR451VSN471MR50S		
220		22×45	1.19	EKMR421VSN221MP45S	470	35×35	1.77	EKMR451VSN471MA35S		
220		25.4×35	1.16	EKMR421VSN221MQ35S	560	35×40	2.02	EKMR451VSN561MA40S		
220		30×25	1.11	EKMR421VSN221MR25S	560	35×45	2.08	EKMR451VSN561MA45S		
270		22×50	1.36	EKMR421VSN271MP50S	680	35×50	2.36	EKMR451VSN681MA50S		

◆RATED RIPPLE CURRENT MULTIPLIERS

●Frequency Multipliers

Frequency(Hz)	50	120	300	1k	10k	50k
160 to 250V _{dc}	0.81	1.00	1.17	1.32	1.45	1.50
315 to 450V _{dc}	0.77	1.00	1.16	1.30	1.41	1.43

The endurance of capacitors is reduced with internal heating produced by ripple current at the rate of halving the lifetime with every 5°C rise. When long life performance is required in actual use, the rms ripple current has to be reduced.



KMQ Series

- Endurance with ripple current : 2,000 hours at 105°C
- Non solvent resistant type
- RoHS Compliant

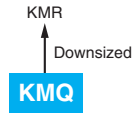

◆ SPECIFICATIONS

Items	Characteristics								
Category	Temperature Range								
Temperature Range	-40 to +105°C (35&50V _{dc}), -25 to +105°C (160 to 450V _{dc})								
Rated Voltage Range	35&50V _{dc} , 160 to 450V _{dc}								
Capacitance Tolerance	±20% (M) (at 20°C, 120Hz)								
Leakage Current	I ≤ 3√CV Where, I : Max. leakage current (μA), C : Nominal capacitance (μF), V : Rated voltage (V) (at 20°C after 5 minutes)								
Dissipation Factor (tanδ)	Rated voltage (V _{dc})	35V		50V		160 to 250V	315 to 400V	420 & 450V	(at 20°C, 120Hz)
	Nominal capacitance (μF)	10,000>C	C ≥ 10,000	10,000>C	C ≥ 10,000	—	—	—	
	tanδ (Max.)	0.30	0.35	0.25	0.30	0.15	0.15	0.20	
Low Temperature Characteristics (Max. Impedance Ratio)	Rated voltage (V _{dc})	35&50V	160 to 250V	315 to 450V					
	Z(-25°C)/Z(+20°C)	4	4	8					
	Z(-40°C)/Z(+20°C)	10	—	—					
Endurance	The following specifications shall be satisfied when the capacitors are restored to 20°C after subjected to DC voltage with the rated ripple current is applied (the peak voltage shall not exceed the rated voltage) for 2,000 hours at 105°C.								
	Capacitance change	≤ ±20% of the initial value							
	D.F. (tanδ)	≤ 200% of the initial specified value							
	Leakage current	≤ The initial specified value							
Shelf Life	The following specifications shall be satisfied when the capacitors are restored to 20°C after exposing them for 1,000 hours at 105°C without voltage applied. Before the measurement, the capacitor shall be preconditioned by applying voltage according to Item 4.1 of JIS C 5101-4.								
	Capacitance change	≤ ±15% of the initial value							
	D.F. (tanδ)	≤ 150% of the initial specified value							
	Leakage current	≤ The initial specified value							

◆ DIMENSIONS [mm]

● Terminal Code : VS (φ22 to φ35) : Standard

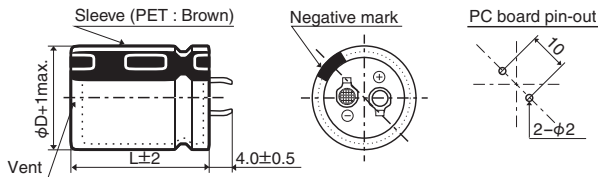

● Terminal Code : LI (φ35)

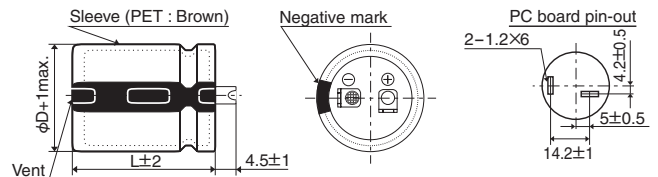

The standard design has no plastic disc.

◆ PART NUMBERING SYSTEM

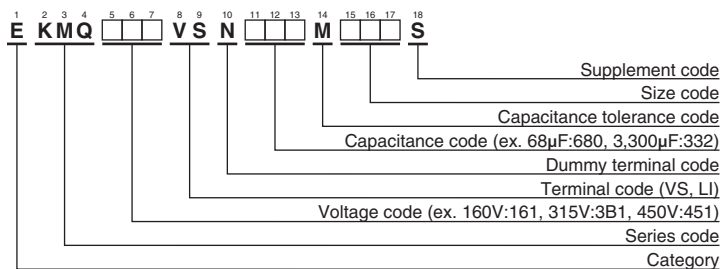

Please refer to "Product code guide (snap-in type)"



◆STANDARD RATINGS

WV (Vdc)	Cap (μF)	Case size φD×L(mm)	tanδ	Rated ripple current (Arms/105°C, 120Hz)	Part No.	WV (Vdc)	Cap (μF)	Case size φD×L(mm)	tanδ	Rated ripple current (Arms/105°C, 120Hz)	Part No.	
35	4,700	22×25	0.30	1.87	EKMQ350VSN472MP25S	160	1,800	30×40	0.15	2.70	EKMQ161VSN182MR40S	
	5,600	22×25	0.30	2.04	EKMQ350VSN562MP25S		1,800	35×30	0.15	2.70	EKMQ161VSN182MA30S	
	5,600	25.4×25	0.30	2.00	EKMQ350VSN562MQ25S		2,200	30×45	0.15	2.90	EKMQ161VSN222MR45S	
	6,800	22×30	0.30	2.36	EKMQ350VSN682MP30S		2,200	35×35	0.15	2.90	EKMQ161VSN222MA35S	
	6,800	25.4×25	0.30	2.21	EKMQ350VSN682MQ25S		2,700	30×50	0.15	3.10	EKMQ161VSN272MR50S	
	8,200	22×35	0.30	2.65	EKMQ350VSN822MP35S		2,700	35×40	0.15	3.10	EKMQ161VSN272MA40S	
	8,200	25.4×30	0.30	2.49	EKMQ350VSN822MQ30S		3,300	35×50	0.15	3.30	EKMQ161VSN332MA50S	
	8,200	30×25	0.30	2.62	EKMQ350VSN822MR25S		180	390	22×25	0.15	1.30	EKMQ181VSN391MP25S
	10,000	22×40	0.35	3.00	EKMQ350VSN103MP40S			470	22×30	0.15	1.40	EKMQ181VSN471MP30S
	10,000	25.4×35	0.35	2.88	EKMQ350VSN103MQ35S			560	22×30	0.15	1.50	EKMQ181VSN561MP30S
	10,000	30×25	0.35	2.90	EKMQ350VSN103MR25S	560		25.4×25	0.15	1.50	EKMQ181VSN561MQ25S	
	12,000	22×50	0.35	3.47	EKMQ350VSN123MP50S	680		22×35	0.15	1.70	EKMQ181VSN681MP35S	
	12,000	25.4×35	0.35	3.15	EKMQ350VSN123MQ35S	680		25.4×30	0.15	1.70	EKMQ181VSN681MQ30S	
	12,000	30×30	0.35	3.25	EKMQ350VSN123MR30S	820		22×40	0.15	2.00	EKMQ181VSN821MP40S	
	12,000	35×25	0.35	3.20	EKMQ350VSN123MA25S	820		25.4×30	0.15	2.00	EKMQ181VSN821MQ30S	
	15,000	25.4×40	0.35	3.61	EKMQ350VSN153MQ40S	820		30×25	0.15	2.00	EKMQ181VSN821MR25S	
	15,000	30×35	0.35	3.78	EKMQ350VSN153MR35S	1,000		22×45	0.15	2.20	EKMQ181VSN102MP45S	
	15,000	35×25	0.35	3.60	EKMQ350VSN153MA25S	1,000	25.4×40	0.15	2.20	EKMQ181VSN102MQ40S		
	18,000	25.4×50	0.35	4.14	EKMQ350VSN183MQ50S	1,000	30×30	0.15	2.20	EKMQ181VSN102MR30S		
	18,000	30×40	0.35	4.30	EKMQ350VSN183MR40S	1,000	35×25	0.15	2.20	EKMQ181VSN102MA25S		
18,000	35×30	0.35	4.10	EKMQ350VSN183MA30S	1,200	25.4×45	0.15	2.30	EKMQ181VSN122MQ45S			
22,000	30×50	0.35	5.00	EKMQ350VSN223MR50S	1,200	30×35	0.15	2.30	EKMQ181VSN122MR35S			
22,000	35×35	0.35	4.64	EKMQ350VSN223MA35S	1,200	35×30	0.15	2.30	EKMQ181VSN122MA30S			
27,000	35×40	0.35	5.37	EKMQ350VSN273MA40S	1,500	25.4×50	0.15	2.50	EKMQ181VSN152MQ50S			
33,000	35×50	0.35	6.00	EKMQ350VSN333MA50S	1,500	30×40	0.15	2.50	EKMQ181VSN152MR40S			
50	2,700	22×25	0.25	1.65	EKMQ500VSN272MP25S	1,500	35×30	0.15	2.50	EKMQ181VSN152MA30S		
	3,300	22×30	0.25	1.92	EKMQ500VSN332MP30S	1,800	30×45	0.15	2.70	EKMQ181VSN182MR45S		
	3,300	25.4×25	0.25	1.76	EKMQ500VSN332MQ25S	1,800	35×35	0.15	2.70	EKMQ181VSN182MA35S		
	3,900	22×30	0.25	2.08	EKMQ500VSN392MP30S	2,200	30×50	0.15	2.90	EKMQ181VSN222MR50S		
	3,900	25.4×25	0.25	2.04	EKMQ500VSN392MQ25S	2,200	35×40	0.15	2.90	EKMQ181VSN222MA40S		
	4,700	22×35	0.25	2.43	EKMQ500VSN472MP35S	2,700	35×50	0.15	3.10	EKMQ181VSN272MA50S		
	4,700	25.4×30	0.25	2.50	EKMQ500VSN472MQ30S	200	390	22×25	0.15	1.31	EKMQ201VSN391MP25S	
	4,700	30×25	0.25	2.29	EKMQ500VSN472MR25S		470	22×30	0.15	1.45	EKMQ201VSN471MP30S	
	5,600	22×40	0.25	2.63	EKMQ500VSN562MP40S		560	22×30	0.15	1.67	EKMQ201VSN561MP30S	
	5,600	25.4×35	0.25	2.61	EKMQ500VSN562MQ35S		560	25.4×25	0.15	1.67	EKMQ201VSN561MQ25S	
	5,600	30×25	0.25	2.80	EKMQ500VSN562MR25S		680	22×40	0.15	1.75	EKMQ201VSN681MP40S	
	6,800	22×50	0.25	3.05	EKMQ500VSN682MP50S		680	25.4×30	0.15	1.75	EKMQ201VSN681MQ30S	
	6,800	25.4×40	0.25	2.94	EKMQ500VSN682MQ40S		820	22×45	0.15	2.04	EKMQ201VSN821MP45S	
	6,800	30×30	0.25	3.30	EKMQ500VSN682MR30S		820	25.4×35	0.15	2.04	EKMQ201VSN821MQ35S	
	6,800	35×25	0.25	2.77	EKMQ500VSN682MA25S		820	30×25	0.15	2.04	EKMQ201VSN821MR25S	
	8,200	25.4×45	0.25	3.60	EKMQ500VSN822MQ45S		1,000	22×50	0.15	2.30	EKMQ201VSN102MP50S	
	8,200	30×35	0.25	3.60	EKMQ500VSN822MR35S	1,000	25.4×45	0.15	2.30	EKMQ201VSN102MQ45S		
	8,200	35×30	0.25	3.60	EKMQ500VSN822MA30S	1,000	30×30	0.15	2.30	EKMQ201VSN102MR30S		
	10,000	25.4×50	0.30	4.00	EKMQ500VSN103MQ50S	1,000	35×25	0.15	2.30	EKMQ201VSN102MA25S		
	10,000	30×40	0.30	4.00	EKMQ500VSN103MR40S	1,200	25.4×50	0.15	2.65	EKMQ201VSN122MQ50S		
10,000	35×30	0.30	4.00	EKMQ500VSN103MA30S	1,200	30×35	0.15	2.65	EKMQ201VSN122MR35S			
12,000	30×50	0.30	4.29	EKMQ500VSN123MR50S	1,200	35×30	0.15	2.65	EKMQ201VSN122MA30S			
12,000	35×35	0.30	4.37	EKMQ500VSN123MA35S	1,500	30×40	0.15	2.80	EKMQ201VSN152MR40S			
15,000	35×40	0.30	4.50	EKMQ500VSN153MA40S	1,500	35×30	0.15	2.80	EKMQ201VSN152MA30S			
18,000	35×50	0.30	5.30	EKMQ500VSN183MA50S	1,800	30×45	0.15	3.08	EKMQ201VSN182MR45S			
160	470	22×25	0.15	1.40	EKMQ161VSN471MP25S	1,800	35×40	0.15	3.08	EKMQ201VSN182MA40S		
	560	22×30	0.15	1.50	EKMQ161VSN561MP30S	2,200	35×45	0.15	3.48	EKMQ201VSN222MA45S		
	680	22×30	0.15	1.70	EKMQ161VSN681MP30S	250	220	22×25	0.15	1.00	EKMQ251VSN221MP25S	
	680	25.4×25	0.15	1.70	EKMQ161VSN681MQ25S		270	22×25	0.15	1.10	EKMQ251VSN271MP25S	
	820	22×35	0.15	2.00	EKMQ161VSN821MP35S		330	22×30	0.15	1.20	EKMQ251VSN331MP30S	
	820	25.4×30	0.15	2.00	EKMQ161VSN821MQ30S		330	25.4×25	0.15	1.20	EKMQ251VSN331MQ25S	
	820	30×25	0.15	2.00	EKMQ161VSN821MR25S		390	22×35	0.15	1.30	EKMQ251VSN391MP35S	
	1,000	22×40	0.15	2.20	EKMQ161VSN102MP40S		390	25.4×25	0.15	1.30	EKMQ251VSN391MQ25S	
	1,000	25.4×35	0.15	2.20	EKMQ161VSN102MQ35S		470	22×40	0.15	1.40	EKMQ251VSN471MP40S	
	1,000	30×25	0.15	2.20	EKMQ161VSN102MR25S		470	25.4×30	0.15	1.40	EKMQ251VSN471MQ30S	
	1,200	25.4×40	0.15	2.30	EKMQ161VSN122MQ40S		470	30×25	0.15	1.40	EKMQ251VSN471MR25S	
	1,200	30×30	0.15	2.30	EKMQ161VSN122MR30S		560	22×45	0.15	1.50	EKMQ251VSN561MP45S	
	1,200	35×25	0.15	2.30	EKMQ161VSN122MA25S	560	25.4×35	0.15	1.50	EKMQ251VSN561MQ35S		
	1,500	25.4×45	0.15	2.50	EKMQ161VSN152MQ45S	560	30×25	0.15	1.50	EKMQ251VSN561MR25S		
	1,500	30×35	0.15	2.50	EKMQ161VSN152MR35S	680	22×50	0.15	1.70	EKMQ251VSN681MP50S		
	1,500	35×30	0.15	2.50	EKMQ161VSN152MA30S	680	25.4×40	0.15	1.70	EKMQ251VSN681MQ40S		
	1,800	25.4×50	0.15	2.70	EKMQ161VSN182MQ50S	680	30×30	0.15	1.70	EKMQ251VSN681MR30S		

◆STANDARD RATINGS

WV (Vdc)	Cap (μF)	Case size φD×L(mm)	tanδ	Rated ripple current (Arms/105°C, 120Hz)	Part No.	WV (Vdc)	Cap (μF)	Case size φD×L(mm)	tanδ	Rated ripple current (Arms/105°C, 120Hz)	Part No.
250	680	35×25	0.15	1.70	EKMQ251VSN681MA25S	400	270	25.4×40	0.15	1.22	EKMQ401VSN271MQ40S
	820	25.4×45	0.15	2.00	EKMQ251VSN821MQ45S		270	30×30	0.15	1.22	EKMQ401VSN271MR30S
	820	30×35	0.15	2.00	EKMQ251VSN821MR35S		270	35×25	0.15	1.22	EKMQ401VSN271MA25S
	820	35×30	0.15	2.00	EKMQ251VSN821MA30S		330	25.4×45	0.15	1.44	EKMQ401VSN331MQ45S
	1,000	30×40	0.15	2.20	EKMQ251VSN102MR40S		330	30×35	0.15	1.44	EKMQ401VSN331MR35S
	1,000	35×30	0.15	2.20	EKMQ251VSN102MA30S		330	35×30	0.15	1.44	EKMQ401VSN331MA30S
	1,200	30×45	0.15	2.30	EKMQ251VSN122MR45S		390	25.4×50	0.15	1.55	EKMQ401VSN391MQ50S
	1,200	35×35	0.15	2.30	EKMQ251VSN122MA35S		390	30×40	0.15	1.55	EKMQ401VSN391MR40S
	1,500	35×45	0.15	2.50	EKMQ251VSN152MA45S		390	35×30	0.15	1.55	EKMQ401VSN391MA30S
	1,800	35×50	0.15	2.70	EKMQ251VSN182MA50S		470	30×45	0.15	1.68	EKMQ401VSN471MR45S
315	150	22×25	0.15	0.82	EKMQ3B1VSN151MP25S	470	35×35	0.15	1.68	EKMQ401VSN471MA35S	
	180	22×30	0.15	0.90	EKMQ3B1VSN181MP30S	560	30×50	0.15	1.90	EKMQ401VSN561MR50S	
	220	22×30	0.15	1.00	EKMQ3B1VSN221MP30S	560	35×40	0.15	1.90	EKMQ401VSN561MA40S	
	220	25.4×25	0.15	1.00	EKMQ3B1VSN221MQ25S	680	35×45	0.15	2.12	EKMQ401VSN681MA45S	
	270	22×35	0.15	1.10	EKMQ3B1VSN271MP35S	82	22×25	0.20	0.64	EKMQ421VSN820MP25S	
	270	25.4×30	0.15	1.10	EKMQ3B1VSN271MQ30S	100	22×25	0.20	0.66	EKMQ421VSN101MP25S	
	330	22×45	0.15	1.20	EKMQ3B1VSN331MP45S	100	25.4×25	0.20	0.66	EKMQ421VSN101MQ25S	
	330	25.4×35	0.15	1.20	EKMQ3B1VSN331MQ35S	120	22×30	0.20	0.81	EKMQ421VSN121MP30S	
	330	30×25	0.15	1.20	EKMQ3B1VSN331MR25S	120	25.4×25	0.20	0.81	EKMQ421VSN121MQ25S	
	390	22×45	0.15	1.30	EKMQ3B1VSN391MP45S	150	22×35	0.20	0.84	EKMQ421VSN151MP35S	
	390	25.4×40	0.15	1.30	EKMQ3B1VSN391MQ40S	150	25.4×30	0.20	0.84	EKMQ421VSN151MQ30S	
	390	30×30	0.15	1.30	EKMQ3B1VSN391MR30S	150	30×25	0.20	0.84	EKMQ421VSN151MR25S	
	390	35×25	0.15	1.30	EKMQ3B1VSN391MA25S	180	22×40	0.20	0.91	EKMQ421VSN181MP40S	
	470	25.4×45	0.15	1.40	EKMQ3B1VSN471MQ45S	180	25.4×30	0.20	0.91	EKMQ421VSN181MQ30S	
	470	30×35	0.15	1.40	EKMQ3B1VSN471MR35S	180	30×25	0.20	0.91	EKMQ421VSN181MR25S	
	470	35×25	0.15	1.40	EKMQ3B1VSN471MA25S	220	22×45	0.20	1.05	EKMQ421VSN221MP45S	
	560	25.4×50	0.15	1.50	EKMQ3B1VSN561MQ50S	220	25.4×35	0.20	1.05	EKMQ421VSN221MQ35S	
	560	30×40	0.15	1.50	EKMQ3B1VSN561MR40S	220	30×30	0.20	1.05	EKMQ421VSN221MR30S	
	560	35×30	0.15	1.50	EKMQ3B1VSN561MA30S	220	35×25	0.20	1.05	EKMQ421VSN221MA25S	
	680	30×45	0.15	1.70	EKMQ3B1VSN681MR45S	270	25.4×40	0.20	1.25	EKMQ421VSN271MQ40S	
680	35×35	0.15	1.70	EKMQ3B1VSN681MA35S	270	30×30	0.20	1.25	EKMQ421VSN271MR30S		
820	30×50	0.15	2.00	EKMQ3B1VSN821MR50S	270	35×25	0.20	1.25	EKMQ421VSN271MA25S		
820	35×40	0.15	2.00	EKMQ3B1VSN821MA40S	330	25.4×50	0.20	1.42	EKMQ421VSN331MQ50S		
1,000	35×45	0.15	2.30	EKMQ3B1VSN102MA45S	330	30×35	0.20	1.42	EKMQ421VSN331MR35S		
350	120	22×25	0.15	0.75	EKMQ351VSN121MP25S	330	35×30	0.20	1.42	EKMQ421VSN331MA30S	
	150	22×30	0.15	0.82	EKMQ351VSN151MP30S	390	30×40	0.20	1.61	EKMQ421VSN391MR40S	
	180	22×30	0.15	0.90	EKMQ351VSN181MP30S	390	35×35	0.20	1.61	EKMQ421VSN391MA35S	
	180	25.4×25	0.15	0.90	EKMQ351VSN181MQ25S	470	30×45	0.20	1.86	EKMQ421VSN471MR45S	
	220	22×35	0.15	1.00	EKMQ351VSN221MP35S	470	35×40	0.20	1.86	EKMQ421VSN471MA40S	
	220	25.4×30	0.15	1.00	EKMQ351VSN221MQ30S	560	35×45	0.20	2.10	EKMQ421VSN561MA45S	
	270	22×40	0.15	1.10	EKMQ351VSN271MP40S	680	35×50	0.20	2.20	EKMQ421VSN681MA50S	
	270	25.4×30	0.15	1.10	EKMQ351VSN271MQ30S	68	22×25	0.20	0.50	EKMQ451VSN680MP25S	
	270	30×25	0.15	1.10	EKMQ351VSN271MR25S	82	22×30	0.20	0.56	EKMQ451VSN820MP30S	
	330	22×45	0.15	1.20	EKMQ351VSN331MP45S	100	22×30	0.20	0.64	EKMQ451VSN101MP30S	
	330	25.4×40	0.15	1.20	EKMQ351VSN331MQ40S	100	25.4×25	0.20	0.64	EKMQ451VSN101MQ25S	
	330	30×30	0.15	1.20	EKMQ351VSN331MR30S	120	22×35	0.20	0.72	EKMQ451VSN121MP35S	
	390	25.4×45	0.15	1.30	EKMQ351VSN391MQ45S	120	25.4×30	0.20	0.72	EKMQ451VSN121MQ30S	
	390	30×35	0.15	1.30	EKMQ351VSN391MR35S	150	22×40	0.20	0.79	EKMQ451VSN151MP40S	
	470	25.4×50	0.15	1.40	EKMQ351VSN471MQ50S	150	25.4×30	0.20	0.79	EKMQ451VSN151MQ30S	
	470	30×35	0.15	1.40	EKMQ351VSN471MR35S	150	30×25	0.20	0.79	EKMQ451VSN151MR25S	
	470	35×30	0.15	1.40	EKMQ351VSN471MA30S	180	22×45	0.20	0.87	EKMQ451VSN181MP45S	
	560	30×45	0.15	1.50	EKMQ351VSN561MR45S	180	25.4×40	0.20	0.87	EKMQ451VSN181MQ40S	
	560	35×35	0.15	1.50	EKMQ351VSN561MA35S	180	30×30	0.20	0.87	EKMQ451VSN181MR30S	
	680	30×50	0.15	1.70	EKMQ351VSN681MR50S	220	25.4×45	0.20	1.00	EKMQ451VSN221MQ45S	
680	35×40	0.15	1.70	EKMQ351VSN681MA40S	220	30×30	0.20	1.00	EKMQ451VSN221MR30S		
820	35×45	0.15	1.90	EKMQ351VSN821MA45S	220	35×25	0.20	1.00	EKMQ451VSN221MA25S		
400	100	22×25	0.15	0.70	EKMQ401VSN101MP25S	270	25.4×50	0.20	1.19	EKMQ451VSN271MQ50S	
	120	22×30	0.15	0.75	EKMQ401VSN121MP30S	270	30×40	0.20	1.19	EKMQ451VSN271MR40S	
	150	22×30	0.15	0.88	EKMQ401VSN151MP30S	270	35×30	0.20	1.19	EKMQ451VSN271MA30S	
	150	25.4×25	0.15	0.88	EKMQ401VSN151MQ25S	330	30×45	0.20	1.38	EKMQ451VSN331MR45S	
	180	22×35	0.15	0.95	EKMQ401VSN181MP35S	330	35×35	0.20	1.38	EKMQ451VSN331MA35S	
	180	25.4×30	0.15	0.95	EKMQ401VSN181MQ30S	390	30×50	0.20	1.55	EKMQ451VSN391MR50S	
	220	22×45	0.15	1.10	EKMQ401VSN221MP45S	390	35×40	0.20	1.55	EKMQ451VSN391MA40S	
	220	25.4×35	0.15	1.10	EKMQ401VSN221MQ35S	470	35×45	0.20	1.74	EKMQ451VSN471MA45S	
	220	30×25	0.15	1.10	EKMQ401VSN221MR25S	560	35×50	0.20	1.90	EKMQ451VSN561MA50S	
	270	22×50	0.15	1.22	EKMQ401VSN271MP50S						



KMQ Series

◆ RATED RIPPLE CURRENT MULTIPLIERS

● Frequency Multipliers

Frequency(Hz)	50	120	300	1k	10k	50k
35, 50V _{dc}	0.95	1.00	1.03	1.05	1.08	1.08
160 to 250V _{dc}	0.81	1.00	1.17	1.32	1.45	1.50
315 to 450V _{dc}	0.77	1.00	1.16	1.30	1.41	1.43

The endurance of capacitors is reduced with internal heating produced by ripple current at the rate of halving the lifetime with every 5°C rise. When long life performance is required in actual use, the rms ripple current has to be reduced.

SMM Series

- Longer life from SMQ series
- Endurance with ripple current : 3,000 hours at 85°C
- Non solvent resistant type
- RoHS Compliant

SMM

↑ Longer life
SMQ



◆ SPECIFICATIONS

Items	Characteristics		
Category Temperature Range	-25 to +85°C		
Rated Voltage Range	160 to 450V _{dc}		
Capacitance Tolerance	±20% (M) (at 20°C, 120Hz)		
Leakage Current	I ≤ 3√CV Where, I : Max. leakage current (µA), C : Nominal capacitance (µF), V : Rated voltage (V) (at 20°C after 5 minutes)		
Dissipation Factor (tanδ)	Rated voltage (V _{dc})	160 to 400V	420 & 450V
	tanδ (Max.)	0.15	0.20
Low Temperature Characteristics (Max. Impedance Ratio)	Rated voltage (V _{dc})	160 to 400V	420 & 450V
	Z(-25°C)/Z(+20°C)	4	8
Endurance	The following specifications shall be satisfied when the capacitors are restored to 20°C after subjected to DC voltage with the rated ripple current is applied (the peak voltage shall not exceed the rated voltage) for 3,000 hours at 85°C.		
	Capacitance change	≤ ±20% of the initial value	
	D.F. (tanδ)	≤ 200% of the initial specified value	
	Leakage current	≤ The initial specified value	
Shelf Life	The following specifications shall be satisfied when the capacitors are restored to 20°C after exposing them for 1,000 hours at 85°C without voltage applied. Before the measurement, the capacitor shall be preconditioned by applying voltage according to Item 4.1 of JIS C 5101-4.		
	Capacitance change	≤ ±15% of the initial value	
	D.F. (tanδ)	≤ 150% of the initial specified value	
	Leakage current	≤ The initial specified value	

◆ DIMENSIONS [mm]

- Terminal Code : VS (φ20 to φ35) : Standard

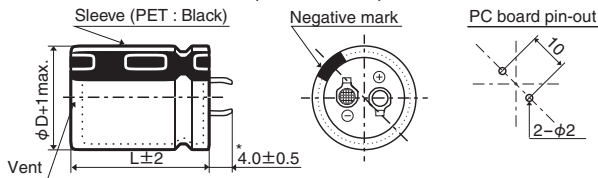

* φD=35mm : 3.5±0.5mm

The standard design has no plastic disc.

- Terminal Code : LI (φ35)

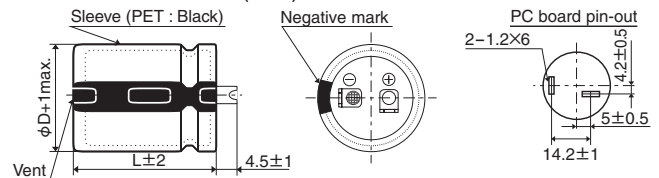

◆ PART NUMBERING SYSTEM

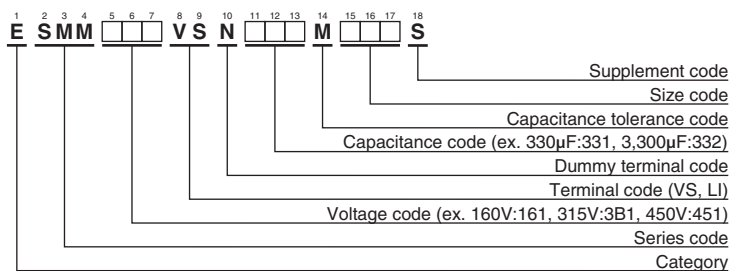

Please refer to "Product code guide (snap-in type)"

◆ RATED RIPPLE CURRENT MULTIPLIERS

- Frequency Multipliers

Frequency(Hz)	50	120	300	1k	10k	50k
160 to 250V _{dc}	0.81	1.00	1.17	1.32	1.45	1.50
315 to 450V _{dc}	0.77	1.00	1.16	1.30	1.41	1.43

The endurance of capacitors is reduced with internal heating produced by ripple current at the rate of halving the lifetime with every 5°C rise. When long life performance is required in actual use, the rms ripple current has to be reduced.



SMM Series

◆STANDARD RATINGS

VV (Vdc)	Cap (μF)	Case size φD×L(mm)	tan δ	Rated ripple current (Arms/85°C,120Hz)	Part No.	VV (Vdc)	Cap (μF)	Case size φD×L(mm)	tan δ	Rated ripple current (Arms/85°C,120Hz)	Part No.	
160	270	20×25	0.15	1.28	ESMM161VSN271MN25S	180	1,200	25.4×45	0.15	3.63	ESMM181VSN122MQ45S	
	270	22×20	0.15	1.30	ESMM161VSN271MP20S		1,200	30×35	0.15	3.55	ESMM181VSN122MR35S	
	330	20×25	0.15	1.55	ESMM161VSN331MN25S		1,200	35×30	0.15	3.49	ESMM181VSN122MA30S	
	390	20×30	0.15	1.63	ESMM161VSN391MN30S		1,500	30×40	0.15	4.10	ESMM181VSN152MR40S	
	390	22×25	0.15	1.63	ESMM161VSN391MP25S		1,500	35×35	0.15	4.02	ESMM181VSN152MA35S	
	390	25.4×20	0.15	1.62	ESMM161VSN391MQ20S		1,800	30×45	0.15	4.55	ESMM181VSN182MR45S	
	470	20×30	0.15	1.90	ESMM161VSN471MN30S		1,800	35×35	0.15	4.54	ESMM181VSN182MA35S	
	470	22×30	0.15	1.86	ESMM161VSN471MP30S		2,200	35×40	0.15	4.83	ESMM181VSN222MA40S	
	470	25.4×25	0.15	1.86	ESMM161VSN471MQ25S		2,700	35×50	0.15	5.30	ESMM181VSN272MA50S	
	560	20×35	0.15	2.14	ESMM161VSN561MN35S		200	220	20×25	0.15	1.19	ESMM201VSN221MN25S
	560	22×30	0.15	2.15	ESMM161VSN561MP30S			220	22×20	0.15	1.18	ESMM201VSN221MP20S
	560	25.4×25	0.15	2.15	ESMM161VSN561MQ25S			270	20×25	0.15	1.39	ESMM201VSN271MN25S
	560	30×20	0.15	2.05	ESMM161VSN561MP20S			270	22×25	0.15	1.37	ESMM201VSN271MP25S
	680	20×40	0.15	2.35	ESMM161VSN681MN40S			270	25.4×20	0.15	1.35	ESMM201VSN271MQ20S
	680	22×35	0.15	2.35	ESMM161VSN681MP35S			330	20×30	0.15	1.56	ESMM201VSN331MN30S
	680	25.4×30	0.15	2.33	ESMM161VSN681MQ30S	330		22×25	0.15	1.51	ESMM201VSN331MP25S	
	680	30×25	0.15	2.33	ESMM161VSN681MR25S	330		25.4×20	0.15	1.49	ESMM201VSN331MQ20S	
	680	35×20	0.15	2.26	ESMM161VSN681MA20S	390		20×35	0.15	1.74	ESMM201VSN391MN35S	
	820	20×45	0.15	2.64	ESMM161VSN821MN45S	390		22×30	0.15	1.73	ESMM201VSN391MP30S	
	820	22×40	0.15	2.68	ESMM161VSN821MP40S	390		25.4×25	0.15	1.71	ESMM201VSN391MQ25S	
	820	25.4×30	0.15	2.65	ESMM161VSN821MQ30S	390		30×20	0.15	1.71	ESMM201VSN391MR20S	
	820	30×25	0.15	2.64	ESMM161VSN821MR25S	470		20×35	0.15	2.03	ESMM201VSN471MN35S	
	820	35×20	0.15	2.49	ESMM161VSN821MA20S	470		22×30	0.15	1.97	ESMM201VSN471MP30S	
	1,000	22×45	0.15	3.02	ESMM161VSN102MP45S	470		25.4×25	0.15	1.95	ESMM201VSN471MQ25S	
	1,000	25.4×35	0.15	3.00	ESMM161VSN102MQ35S	470		30×20	0.15	1.88	ESMM201VSN471MR20S	
	1,000	30×30	0.15	2.96	ESMM161VSN102MR30S	560		20×40	0.15	2.18	ESMM201VSN561MN40S	
	1,000	35×25	0.15	3.13	ESMM161VSN102MA25S	560		22×35	0.15	2.18	ESMM201VSN561MP35S	
	1,200	22×50	0.15	3.47	ESMM161VSN122MP50S	560	25.4×30	0.15	2.15	ESMM201VSN561MQ30S		
	1,200	25.4×40	0.15	3.43	ESMM161VSN122MQ40S	560	30×25	0.15	2.15	ESMM201VSN561MR25S		
	1,200	30×30	0.15	3.41	ESMM161VSN122MR30S	560	35×20	0.15	2.05	ESMM201VSN561MA20S		
	1,200	35×25	0.15	3.40	ESMM161VSN122MA25S	680	20×50	0.15	2.48	ESMM201VSN681MN50S		
	1,500	25.4×50	0.15	3.96	ESMM161VSN152MQ50S	680	22×40	0.15	2.48	ESMM201VSN681MP40S		
	1,500	30×35	0.15	3.96	ESMM161VSN152MR35S	680	25.4×30	0.15	2.48	ESMM201VSN681MQ30S		
1,500	35×30	0.15	3.94	ESMM161VSN152MA30S	680	30×25	0.15	2.48	ESMM201VSN681MR25S			
1,800	30×40	0.15	4.31	ESMM161VSN182MR40S	680	35×20	0.15	2.36	ESMM201VSN681MA20S			
1,800	35×35	0.15	4.28	ESMM161VSN182MA35S	820	22×45	0.15	2.81	ESMM201VSN821MP45S			
2,200	30×50	0.15	4.96	ESMM161VSN222MR50S	820	25.4×35	0.15	2.79	ESMM201VSN821MQ35S			
2,200	35×40	0.15	4.96	ESMM161VSN222MA40S	820	30×30	0.15	2.80	ESMM201VSN821MR30S			
2,700	35×45	0.15	5.57	ESMM161VSN272MA45S	820	35×25	0.15	2.83	ESMM201VSN821MA25S			
3,300	35×50	0.15	6.21	ESMM161VSN332MA50S	1,000	22×50	0.15	3.28	ESMM201VSN102MP50S			
180	220	22×20	0.15	1.18	ESMM181VSN221MP20S	1,000	25.4×40	0.15	3.28	ESMM201VSN102MQ40S		
	270	20×25	0.15	1.29	ESMM181VSN271MN25S	1,000	30×35	0.15	3.15	ESMM201VSN102MR35S		
	330	20×30	0.15	1.77	ESMM181VSN331MN30S	1,000	35×30	0.15	3.26	ESMM201VSN102MA30S		
	330	22×25	0.15	1.77	ESMM181VSN331MP25S	1,200	25.4×45	0.15	3.61	ESMM201VSN122MQ45S		
	330	25.4×20	0.15	1.49	ESMM181VSN331MQ20S	1,200	30×35	0.15	3.61	ESMM201VSN122MR35S		
	390	20×30	0.15	1.84	ESMM181VSN391MN30S	1,200	35×30	0.15	3.57	ESMM201VSN122MA30S		
	390	22×25	0.15	1.84	ESMM181VSN391MP25S	1,500	30×45	0.15	4.13	ESMM201VSN152MR45S		
	470	20×35	0.15	1.91	ESMM181VSN471MN35S	1,500	35×35	0.15	4.06	ESMM201VSN152MA35S		
	470	22×30	0.15	1.91	ESMM181VSN471MP30S	1,800	30×50	0.15	4.60	ESMM201VSN182MR50S		
	470	25.4×25	0.15	2.08	ESMM181VSN471MQ25S	1,800	35×40	0.15	4.59	ESMM201VSN182MA40S		
	470	30×20	0.15	1.88	ESMM181VSN471MR20S	2,200	35×45	0.15	5.25	ESMM201VSN222MA45S		
	560	20×40	0.15	2.15	ESMM181VSN561MN40S	220	180	22×20	0.15	1.06	ESMM221VSN181MP20S	
	560	22×35	0.15	2.25	ESMM181VSN561MP35S		220	20×25	0.15	1.25	ESMM221VSN221MN25S	
	560	25.4×25	0.15	2.25	ESMM181VSN561MQ25S		270	20×30	0.15	1.46	ESMM221VSN271MN30S	
	680	20×45	0.15	2.41	ESMM181VSN681MN45S		270	22×25	0.15	1.47	ESMM221VSN271MP25S	
	680	22×35	0.15	2.48	ESMM181VSN681MP35S		270	25.4×20	0.15	1.35	ESMM221VSN271MQ20S	
	680	25.4×30	0.15	2.50	ESMM181VSN681MQ30S		330	20×35	0.15	1.64	ESMM221VSN331MN35S	
	680	30×25	0.15	2.46	ESMM181VSN681MR25S		330	22×30	0.15	1.70	ESMM221VSN331MP30S	
	680	35×20	0.15	2.26	ESMM181VSN681MA20S		330	25.4×25	0.15	1.69	ESMM221VSN331MQ25S	
	820	20×50	0.15	2.72	ESMM181VSN821MN50S		330	30×20	0.15	1.58	ESMM221VSN331MR20S	
	820	22×40	0.15	2.86	ESMM181VSN821MP40S		390	20×35	0.15	1.84	ESMM221VSN391MN35S	
	820	25.4×35	0.15	2.75	ESMM181VSN821MQ35S		390	22×30	0.15	1.89	ESMM221VSN391MP30S	
	820	30×25	0.15	2.69	ESMM181VSN821MR25S		390	25.4×25	0.15	1.84	ESMM221VSN391MQ25S	
	1,000	22×50	0.15	3.10	ESMM181VSN102MP50S		390	30×20	0.15	1.71	ESMM221VSN391MR20S	
	1,000	25.4×40	0.15	3.06	ESMM181VSN102MQ40S		470	20×40	0.15	2.12	ESMM221VSN471MN40S	
	1,000	30×30	0.15	3.10	ESMM181VSN102MR30S		470	22×35	0.15	2.08	ESMM221VSN471MP35S	
	1,000	35×25	0.15	2.98	ESMM181VSN102MA25S		470	25.4×30	0.15	2.08	ESMM221VSN471MQ30S	

Product specifications in this catalog are subject to change without notice. Request our product specifications before purchase and/or use. Please use our products based on the information contained in this catalog and product specifications.

◆STANDARD RATINGS

WV (Vdc)	Cap (μF)	Case size φD×L(mm)	tanδ	Rated ripple current (Arms/85°C,120Hz)	Part No.	WV (Vdc)	Cap (μF)	Case size φD×L(mm)	tanδ	Rated ripple current (Arms/85°C,120Hz)	Part No.
220	470	30×25	0.15	2.12	ESMM221VSN471MR25S	315	180	22×30	0.15	1.29	ESMM3B1VSN181MP30S
	470	35×20	0.15	1.88	ESMM221VSN471MA20S		180	25.4×25	0.15	1.38	ESMM3B1VSN181MQ25S
	560	20×50	0.15	2.33	ESMM221VSN561MN50S		180	30×20	0.15	1.16	ESMM3B1VSN181MR20S
	560	22×40	0.15	2.33	ESMM221VSN561MP40S		220	20×35	0.15	1.30	ESMM3B1VSN221MN35S
	560	25.4×35	0.15	2.38	ESMM221VSN561MQ35S		220	22×30	0.15	1.41	ESMM3B1VSN221MP30S
	560	30×25	0.15	2.31	ESMM221VSN561MR25S		220	25.4×25	0.15	1.47	ESMM3B1VSN221MQ25S
	560	35×20	0.15	2.14	ESMM221VSN561MA20S		220	30×20	0.15	1.28	ESMM3B1VSN221MR20S
	680	22×45	0.15	2.63	ESMM221VSN681MP45S		270	20×45	0.15	1.52	ESMM3B1VSN271MN45S
	680	25.4×35	0.15	2.68	ESMM221VSN681MQ35S		270	22×35	0.15	1.68	ESMM3B1VSN271MP35S
	680	30×30	0.15	2.62	ESMM221VSN681MR30S		270	25.4×30	0.15	1.70	ESMM3B1VSN271MQ30S
	680	35×25	0.15	2.58	ESMM221VSN681MA25S		270	30×25	0.15	1.55	ESMM3B1VSN271MR25S
	820	25.4×45	0.15	3.01	ESMM221VSN821MQ45S		270	35×20	0.15	1.43	ESMM3B1VSN271MA20S
	820	30×35	0.15	2.99	ESMM221VSN821MP35S		330	20×50	0.15	1.73	ESMM3B1VSN331MP30S
	820	35×30	0.15	2.79	ESMM221VSN821MA30S		330	22×40	0.15	1.91	ESMM3B1VSN331MP40S
	1,000	25.4×50	0.15	3.40	ESMM221VSN102MQ50S		330	25.4×35	0.15	1.94	ESMM3B1VSN331MQ35S
	1,000	30×35	0.15	3.42	ESMM221VSN102MR35S		330	30×25	0.15	1.98	ESMM3B1VSN331MR25S
	1,000	35×30	0.15	3.29	ESMM221VSN102MA30S		390	22×45	0.15	2.07	ESMM3B1VSN391MP45S
	1,200	30×40	0.15	3.88	ESMM221VSN122MR40S		390	25.4×40	0.15	2.11	ESMM3B1VSN391MQ40S
	1,200	35×35	0.15	3.68	ESMM221VSN122MA35S		390	30×30	0.15	2.15	ESMM3B1VSN391MR30S
	1,500	30×50	0.15	4.44	ESMM221VSN152MR50S		390	35×25	0.15	1.95	ESMM3B1VSN391MA25S
1,500	35×40	0.15	4.10	ESMM221VSN152MA40S	470	25.4×45	0.15	2.31	ESMM3B1VSN471MQ45S		
1,800	35×45	0.15	4.52	ESMM221VSN182MA45S	470	30×35	0.15	2.38	ESMM3B1VSN471MR35S		
250	150	22×20	0.15	0.97	ESMM251VSN151MP20S	470	35×30	0.15	2.46	ESMM3B1VSN471MA30S	
	180	20×25	0.15	1.20	ESMM251VSN181MN25S	560	25.4×50	0.15	2.46	ESMM3B1VSN561MQ50S	
	180	22×20	0.15	1.06	ESMM251VSN181MP20S	560	30×35	0.15	2.63	ESMM3B1VSN561MR35S	
	220	20×25	0.15	1.26	ESMM251VSN221MN25S	560	35×30	0.15	2.69	ESMM3B1VSN561MA30S	
	220	22×25	0.15	1.24	ESMM251VSN221MP25S	680	30×45	0.15	2.82	ESMM3B1VSN681MR45S	
	220	25.4×20	0.15	1.22	ESMM251VSN221MQ20S	680	35×35	0.15	3.05	ESMM3B1VSN681MA35S	
	270	20×30	0.15	1.42	ESMM251VSN271MN30S	820	30×50	0.15	3.28	ESMM3B1VSN821MR50S	
	270	22×25	0.15	1.50	ESMM251VSN271MP25S	820	35×40	0.15	3.45	ESMM3B1VSN821MA40S	
	330	20×35	0.15	1.68	ESMM251VSN331MN35S	1,000	35×45	0.15	3.59	ESMM3B1VSN102MA45S	
	330	22×30	0.15	1.66	ESMM251VSN331MP30S	350	82	22×20	0.15	0.72	ESMM351VSN820MP20S
	330	25.4×25	0.15	1.61	ESMM251VSN331MQ25S		100	20×25	0.15	0.81	ESMM351VSN101MN25S
	330	30×20	0.15	1.58	ESMM251VSN331MR20S		120	20×30	0.15	0.96	ESMM351VSN121MN30S
	390	20×40	0.15	1.92	ESMM251VSN391MN40S		120	22×25	0.15	1.04	ESMM351VSN121MP25S
	390	22×35	0.15	1.88	ESMM251VSN391MP35S		120	25.4×20	0.15	0.90	ESMM351VSN121MQ20S
	390	25.4×30	0.15	1.88	ESMM251VSN391MQ30S		150	20×30	0.15	1.10	ESMM351VSN151MN30S
	390	30×25	0.15	1.86	ESMM251VSN391MR25S		150	22×30	0.15	1.20	ESMM351VSN151MP30S
	390	35×20	0.15	1.71	ESMM251VSN391MA20S		150	25.4×25	0.15	1.22	ESMM351VSN151MQ25S
	470	20×50	0.15	2.06	ESMM251VSN471MN50S		150	30×20	0.15	1.06	ESMM351VSN151MR20S
	470	22×35	0.15	2.15	ESMM251VSN471MP35S		180	20×35	0.15	1.24	ESMM351VSN181MN35S
	470	25.4×35	0.15	2.15	ESMM251VSN471MQ35S		180	22×30	0.15	1.34	ESMM351VSN181MP30S
470	30×25	0.15	2.05	ESMM251VSN471MR25S	180		25.4×25	0.15	1.37	ESMM351VSN181MQ25S	
470	35×20	0.15	1.88	ESMM251VSN471MA20S	180		30×20	0.15	1.16	ESMM351VSN181MR20S	
560	22×40	0.15	2.48	ESMM251VSN561MP40S	220		20×45	0.15	1.37	ESMM351VSN221MN45S	
560	25.4×35	0.15	2.35	ESMM251VSN561MQ35S	220		22×35	0.15	1.47	ESMM351VSN221MP35S	
560	30×25	0.15	2.35	ESMM251VSN561MR25S	220		25.4×30	0.15	1.53	ESMM351VSN221MQ30S	
680	22×50	0.15	2.61	ESMM251VSN681MP50S	220		30×25	0.15	1.54	ESMM351VSN221MR25S	
680	25.4×40	0.15	2.67	ESMM251VSN681MQ40S	220		35×20	0.15	1.29	ESMM351VSN221MA20S	
680	30×30	0.15	2.71	ESMM251VSN681MR30S	270		20×50	0.15	1.56	ESMM351VSN271MN50S	
680	35×25	0.15	2.58	ESMM251VSN681MA25S	270		22×40	0.15	1.70	ESMM351VSN271MP40S	
820	25.4×45	0.15	3.01	ESMM251VSN821MQ45S	270	25.4×35	0.15	1.73	ESMM351VSN271MQ35S		
820	30×35	0.15	2.98	ESMM251VSN821MP35S	270	30×25	0.15	1.80	ESMM351VSN271MR25S		
820	35×30	0.15	2.96	ESMM251VSN821MA30S	270	35×20	0.15	1.49	ESMM351VSN271MA20S		
1,000	30×40	0.15	3.56	ESMM251VSN102MR40S	330	22×45	0.15	1.87	ESMM351VSN331MP45S		
1,000	35×35	0.15	3.48	ESMM251VSN102MA35S	330	25.4×35	0.15	1.97	ESMM351VSN331MQ35S		
1,200	30×45	0.15	3.99	ESMM251VSN122MR45S	330	30×30	0.15	2.03	ESMM351VSN331MR30S		
1,200	35×35	0.15	3.84	ESMM251VSN122MA35S	330	35×25	0.15	1.80	ESMM351VSN331MA25S		
1,500	35×40	0.15	4.33	ESMM251VSN152MA40S	390	25.4×40	0.15	2.14	ESMM351VSN391MQ40S		
1,800	35×50	0.15	4.54	ESMM251VSN182MA50S	390	30×35	0.15	2.23	ESMM351VSN391MR35S		
315	100	22×20	0.15	0.79	ESMM3B1VSN101MP20S	390	35×30	0.15	2.30	ESMM351VSN391MA30S	
	120	20×25	0.15	0.89	ESMM3B1VSN121MN25S	470	25.4×50	0.15	2.55	ESMM351VSN471MQ50S	
	120	25.4×20	0.15	0.90	ESMM3B1VSN121MQ20S	470	30×35	0.15	2.53	ESMM351VSN471MR35S	
	150	20×30	0.15	1.05	ESMM3B1VSN151MN30S	470	35×30	0.15	2.55	ESMM351VSN471MA30S	
	150	22×25	0.15	1.06	ESMM3B1VSN151MP25S	560	30×40	0.15	2.73	ESMM351VSN561MR40S	
	150	25.4×20	0.15	1.00	ESMM3B1VSN151MQ20S	560	35×35	0.15	2.75	ESMM351VSN561MA35S	
	180	20×35	0.15	1.18	ESMM3B1VSN181MN35S	680	30×50	0.15	3.15	ESMM351VSN681MR50S	

SMM Series

◆STANDARD RATINGS

WV (Vdc)	Cap (μF)	Case size φD×L(mm)	tan δ	Rated ripple current (Arms/85°C,120Hz)	Part No.	WV (Vdc)	Cap (μF)	Case size φD×L(mm)	tan δ	Rated ripple current (Arms/85°C,120Hz)	Part No.	
350	680	35×40	0.15	3.15	ESMM351VSN681MA40S	420	180	20×50	0.20	1.27	ESMM421VSN181MN50S	
	820	35×45	0.15	3.47	ESMM351VSN821MA45S		180	22×40	0.20	1.33	ESMM421VSN181MP40S	
	1,000	35×50	0.15	3.60	ESMM351VSN102MA50S		180	25.4×35	0.20	1.42	ESMM421VSN181MQ35S	
400	68	20×25	0.15	0.75	ESMM401VSN680MN25S		180	30×25	0.20	1.48	ESMM421VSN181MR25S	
	68	22×20	0.15	0.65	ESMM401VSN680MP20S		180	35×20	0.20	1.16	ESMM421VSN181MA20S	
	82	20×25	0.15	0.82	ESMM401VSN820MN25S		220	22×45	0.20	1.55	ESMM421VSN221MP45S	
	82	22×25	0.15	0.84	ESMM401VSN820MP25S		220	25.4×35	0.20	1.58	ESMM421VSN221MQ35S	
	82	25.4×20	0.15	0.74	ESMM401VSN820MQ20S		220	30×30	0.20	1.65	ESMM421VSN221MR30S	
	100	20×30	0.15	0.95	ESMM401VSN101MP30S		220	35×25	0.20	1.47	ESMM421VSN221MA25S	
	100	22×25	0.15	0.99	ESMM401VSN101MP25S		270	25.4×40	0.20	1.74	ESMM421VSN271MQ40S	
	100	25.4×20	0.15	0.82	ESMM401VSN101MQ20S		270	30×35	0.20	1.90	ESMM421VSN271MR35S	
	120	20×35	0.15	1.07	ESMM401VSN121MN35S		270	35×30	0.20	1.94	ESMM421VSN271MA30S	
	120	22×30	0.15	1.09	ESMM401VSN121MP30S		330	25.4×50	0.20	2.20	ESMM421VSN331MQ50S	
	120	25.4×25	0.15	1.13	ESMM401VSN121MQ25S		330	30×35	0.20	1.98	ESMM421VSN331MR35S	
	120	30×20	0.15	0.95	ESMM401VSN121MR20S		330	35×35	0.20	2.17	ESMM421VSN331MA35S	
	150	20×40	0.15	1.22	ESMM401VSN151MN40S		390	30×40	0.20	2.22	ESMM421VSN391MR40S	
	150	22×35	0.15	1.24	ESMM401VSN151MP35S		390	35×35	0.20	2.27	ESMM421VSN391MA35S	
	150	25.4×30	0.15	1.27	ESMM401VSN151MQ30S		470	30×45	0.20	2.50	ESMM421VSN471MR45S	
	150	30×25	0.15	1.20	ESMM401VSN151MR25S		470	35×40	0.20	2.61	ESMM421VSN471MA40S	
	180	20×45	0.15	1.28	ESMM401VSN181MN45S		560	35×45	0.20	2.95	ESMM421VSN561MA45S	
	180	22×40	0.15	1.41	ESMM401VSN181MP40S		680	35×50	0.20	3.15	ESMM421VSN681MA50S	
	180	25.4×30	0.15	1.44	ESMM401VSN181MQ30S		450	47	22×20	0.20	0.54	ESMM451VSN470MP20S
	180	30×25	0.15	1.52	ESMM401VSN181MR25S			56	20×25	0.20	0.61	ESMM451VSN560MN25S
	180	35×20	0.15	1.16	ESMM401VSN181MA20S			56	22×20	0.20	0.59	ESMM451VSN560MP20S
	220	20×50	0.15	1.41	ESMM401VSN221MN50S	68		20×30	0.20	0.71	ESMM451VSN680MN30S	
	220	22×45	0.15	1.58	ESMM401VSN221MP45S	68		22×25	0.20	0.71	ESMM451VSN680MP25S	
	220	25.4×35	0.15	1.64	ESMM401VSN221MQ35S	68		25.4×20	0.20	0.68	ESMM451VSN680MQ20S	
	220	30×30	0.15	1.66	ESMM401VSN221MR30S	82		20×35	0.20	0.80	ESMM451VSN820MN35S	
	220	35×25	0.15	1.47	ESMM401VSN221MA25S	82		22×25	0.20	0.86	ESMM451VSN820MP25S	
	270	22×50	0.15	1.65	ESMM401VSN271MP50S	82		25.4×20	0.20	0.74	ESMM451VSN820MQ20S	
	270	25.4×40	0.15	1.79	ESMM401VSN271MQ40S	82		30×20	0.20	0.79	ESMM451VSN820MR20S	
	270	30×30	0.15	1.82	ESMM401VSN271MR30S	100		20×35	0.20	0.88	ESMM451VSN101MN35S	
	270	35×25	0.15	1.63	ESMM401VSN271MA25S	100		22×30	0.20	0.95	ESMM451VSN101MP30S	
	330	25.4×45	0.15	2.00	ESMM401VSN331MQ45S	100		25.4×25	0.20	0.97	ESMM451VSN101MQ25S	
	330	30×35	0.15	2.05	ESMM401VSN331MR35S	100		30×20	0.20	0.87	ESMM451VSN101MR20S	
	330	35×30	0.15	2.05	ESMM401VSN331MA30S	120		20×40	0.20	0.99	ESMM451VSN121MN40S	
	390	25.4×50	0.15	2.12	ESMM401VSN391MQ50S	120		22×35	0.20	1.07	ESMM451VSN121MP35S	
	390	30×40	0.15	2.26	ESMM401VSN391MR40S	120		25.4×30	0.20	1.09	ESMM451VSN121MQ30S	
	390	35×35	0.15	2.28	ESMM401VSN391MA35S	120		30×25	0.20	1.12	ESMM451VSN121MR25S	
470	30×45	0.15	2.51	ESMM401VSN471MR45S	120	35×20		0.20	0.99	ESMM451VSN121MA20S		
470	35×35	0.15	2.54	ESMM401VSN471MA35S	150	20×45		0.20	1.13	ESMM451VSN151MN45S		
560	30×50	0.15	2.85	ESMM401VSN561MR50S	150	22×40		0.20	1.18	ESMM451VSN151MP40S		
560	35×40	0.15	2.85	ESMM401VSN561MA40S	150	25.4×30		0.20	1.25	ESMM451VSN151MQ30S		
680	35×50	0.15	3.10	ESMM401VSN681MA50S	150	30×25		0.20	1.29	ESMM451VSN151MR25S		
420	47	22×20	0.20	0.54	ESMM421VSN470MP20S	150		35×20	0.20	1.06	ESMM451VSN151MA20S	
	56	20×25	0.20	0.58	ESMM421VSN560MN25S	180		22×45	0.20	1.32	ESMM451VSN181MP45S	
	56	22×20	0.20	0.59	ESMM421VSN560MP20S	180		25.4×35	0.20	1.40	ESMM451VSN181MQ35S	
	68	20×25	0.20	0.70	ESMM421VSN680MN25S	180		30×30	0.20	1.45	ESMM451VSN181MR30S	
	68	25.4×20	0.20	0.68	ESMM421VSN680MQ20S	180		35×25	0.20	1.33	ESMM451VSN181MA25S	
	82	20×30	0.20	0.80	ESMM421VSN820MN30S	220		22×50	0.20	1.48	ESMM451VSN221MP50S	
	82	22×25	0.20	0.85	ESMM421VSN820MP25S	220		25.4×40	0.20	1.59	ESMM451VSN221MQ40S	
	82	25.4×20	0.20	0.74	ESMM421VSN820MQ20S	220		30×30	0.20	1.64	ESMM451VSN221MR30S	
	100	20×35	0.20	0.90	ESMM421VSN101MN35S	220		35×25	0.20	1.66	ESMM451VSN221MA25S	
	100	22×30	0.20	0.97	ESMM421VSN101MP30S	270		25.4×45	0.20	1.73	ESMM451VSN271MQ45S	
	100	25.4×25	0.20	0.98	ESMM421VSN101MQ25S	270		30×35	0.20	1.89	ESMM451VSN271MR35S	
	100	30×20	0.20	0.87	ESMM421VSN101MR20S	270		35×30	0.20	1.90	ESMM451VSN271MA30S	
	120	20×35	0.20	1.04	ESMM421VSN121MN35S	330		25.4×50	0.20	2.12	ESMM451VSN331MQ50S	
	120	22×30	0.20	1.07	ESMM421VSN121MP30S	330	30×40	0.20	2.12	ESMM451VSN331MR40S		
	120	25.4×25	0.20	1.08	ESMM421VSN121MQ25S	330	35×35	0.20	2.15	ESMM451VSN331MA35S		
	120	30×20	0.20	0.95	ESMM421VSN121MR20S	390	30×45	0.20	2.35	ESMM451VSN391MR45S		
	150	20×40	0.20	1.17	ESMM421VSN151MN40S	390	35×40	0.20	2.38	ESMM451VSN391MA40S		
	150	22×35	0.20	1.21	ESMM421VSN151MP35S	470	30×50	0.20	2.65	ESMM451VSN471MR50S		
	150	25.4×30	0.20	1.26	ESMM421VSN151MQ30S	470	35×45	0.20	2.68	ESMM451VSN471MA45S		
	150	30×25	0.20	1.30	ESMM421VSN151MR25S	560	35×50	0.20	2.88	ESMM451VSN561MA50S		
	150	35×20	0.20	1.11	ESMM421VSN151MA20S							

New!

KMT Series

- Higher ripple current from KMS series
- Endurance with ripple current : 3,000 hours at 105°C
- Rated voltage range : 420, 450V_{dc}, Capacitance range : 82 to 680μF
- For inverter control, switching power supplies
- Non solvent resistant type
- RoHS Compliant

KMT

Higher ripple

KMS



SPECIFICATIONS

Items	Characteristics	
Category	Temperature Range	
Temperature Range	-25 to +105°C	
Rated Voltage Range	420, 450V _{dc}	
Capacitance Tolerance	±20% (M) (at 20°C, 120Hz)	
Leakage Current	$I \leq 3\sqrt{CV}$ Where, I : Max. leakage current (μA), C : Nominal capacitance (μF), V : Rated voltage (V) (at 20°C after 5 minutes)	
Dissipation Factor (tanδ)	Rated voltage (V _{dc})	420 & 450V
	tanδ (Max.)	0.20 (at 20°C, 120Hz)
Low Temperature Characteristics (Max. Impedance Ratio)	Rated voltage (V _{dc})	420 & 450V
	Z(-25°C)/Z(+20°C)	8 (at 120Hz)
Endurance	The following specifications shall be satisfied when the capacitors are restored to 20°C after subjected to DC voltage with the rated ripple current is applied (the peak voltage shall not exceed the rated voltage) for 3,000 hours at 105°C.	
	Capacitance change	≤ ±20% of the initial value
	D.F. (tanδ)	≤ 200% of the initial specified value
	Leakage current	≤ The initial specified value
Shelf Life	The following specifications shall be satisfied when the capacitors are restored to 20°C after exposing them for 1,000 hours at 105°C without voltage applied. Before the measurement, the capacitor shall be preconditioned by applying voltage according to Item 4.1 of JIS C 5101-4.	
	Capacitance change	≤ ±15% of the initial value
	D.F. (tanδ)	≤ 150% of the initial specified value
	Leakage current	≤ The initial specified value

DIMENSIONS [mm]

● Terminal Code : VS (φ22 to φ35) : Standard

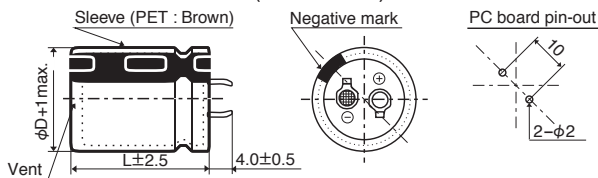

● Terminal Code : LI (φ35)

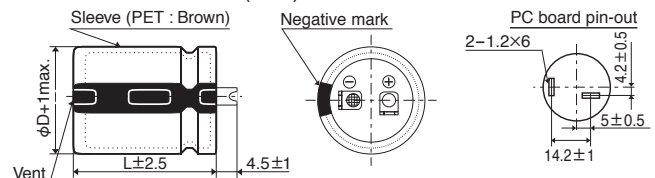

The standard design has no plastic disc.

PART NUMBERING SYSTEM

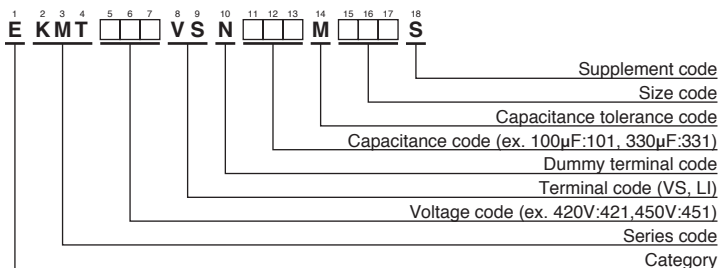

Please refer to "Product code guide (snap-in type)"

◆STANDARD RATINGS

WV (V _{dc})	Cap (μF)	Case size φD×L(mm)	tan δ	Rated ripple current (A _{rms} /105°C,120Hz)	Part No.	WV (V _{dc})	Cap (μF)	Case size φD×L(mm)	tan δ	Rated ripple current (A _{rms} /105°C,120Hz)	Part No.
420	100	22×25	0.20	0.89	EKMT421VSN101MP25S	450	82	22×25	0.20	0.81	EKMT451VSN820MP25S
	120	22×30	0.20	1.06	EKMT421VSN121MP30S		100	22×30	0.20	0.97	EKMT451VSN101MP30S
	120	25.4×25	0.20	1.09	EKMT421VSN121MQ25S		100	25.4×25	0.20	1.04	EKMT451VSN101MQ25S
	150	22×35	0.20	1.21	EKMT421VSN151MP35S		120	22×35	0.20	1.08	EKMT451VSN121MP35S
	180	22×40	0.20	1.34	EKMT421VSN181MP40S		150	22×40	0.20	1.22	EKMT451VSN151MP40S
	180	25.4×30	0.20	1.28	EKMT421VSN181MQ30S		150	25.4×35	0.20	1.31	EKMT451VSN151MQ35S
	180	30×25	0.20	1.42	EKMT421VSN221MR30S		150	30×25	0.20	1.31	EKMT451VSN151MR25S
	220	22×45	0.20	1.47	EKMT421VSN221MP45S		180	22×45	0.20	1.35	EKMT451VSN181MP45S
	220	22×50	0.20	1.60	EKMT421VSN221MP50S		180	22×50	0.20	1.42	EKMT451VSN181MP50S
	220	25.4×35	0.20	1.47	EKMT421VSN221MQ35S		180	25.4×40	0.20	1.35	EKMT451VSN181MQ40S
	220	30×30	0.20	1.64	EKMT421VSN221MR30S		180	30×30	0.20	1.49	EKMT451VSN181MR30S
	220	35×25	0.20	1.64	EKMT421VSN221MA25S		180	35×25	0.20	1.60	EKMT451VSN181MA25S
	270	25.4×40	0.20	1.63	EKMT421VSN271MQ40S		220	25.4×45	0.20	1.55	EKMT451VSN221MQ45S
	270	25.4×45	0.20	1.79	EKMT421VSN271MQ45S		220	30×35	0.20	1.71	EKMT451VSN221MR35S
	270	30×35	0.20	1.87	EKMT421VSN271MR35S		270	25.4×50	0.20	1.74	EKMT451VSN271MQ50S
	330	25.4×50	0.20	1.93	EKMT421VSN331MQ50S		270	30×40	0.20	1.90	EKMT451VSN271MR40S
	330	30×40	0.20	2.10	EKMT421VSN331MR40S		270	35×30	0.20	1.90	EKMT451VSN271MA30S
	330	35×30	0.20	2.05	EKMT421VSN331MA30S		330	30×45	0.20	2.20	EKMT451VSN331MR45S
	390	30×45	0.20	2.32	EKMT421VSN391MR45S		330	35×35	0.20	2.20	EKMT451VSN331MA35S
	390	35×35	0.20	2.32	EKMT421VSN391MA35S		390	30×50	0.20	2.40	EKMT451VSN391MR50S
470	30×50	0.20	2.51	EKMT421VSN471MR50S	390	35×40	0.20	2.42	EKMT451VSN391MA40S		
470	35×40	0.20	2.62	EKMT421VSN471MA40S	470	35×45	0.20	2.67	EKMT451VSN471MA45S		
560	35×45	0.20	2.88	EKMT421VSN561MA45S	560	35×50	0.20	2.85	EKMT451VSN561MA50S		
680	35×50	0.20	3.10	EKMT421VSN681MA50S							

◆RATED RIPPLE CURRENT MULTIPLIERS

●Frequency Multipliers

Frequency(Hz)	50	120	300	1k	10k	50k
420, 450V _{dc}	0.68	1.00	1.16	1.30	1.41	1.43

The endurance of capacitors is reduced with internal heating produced by ripple current at the rate of halving the lifetime with every 5°C rise. When long life performance is required in actual use, the rms ripple current has to be reduced.

KMS Series

- For solar power generation
- Endurance with ripple current : 105°C 3,000 hours
- Rated voltage range : 160 to 500V
- Capacitance range : 47 to 3,300μF
- Non solvent resistant type
- RoHS Compliant

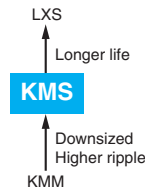

500V Lineup!



◆ SPECIFICATIONS

Items	Characteristics	
Category	-25 to +105°C	
Temperature Range		
Rated Voltage Range	160 to 500V _{dc}	
Capacitance Tolerance	±20% (M) (at 20°C, 120Hz)	
Leakage Current	I ≤ 3√CV Where, I : Max. leakage current (μA), C : Nominal capacitance (μF), V : Rated voltage (V) (at 20°C after 5 minutes)	
Dissipation Factor (tanδ)	Rated voltage (V _{dc})	160 to 400V 420 to 500V
	tanδ (Max.)	0.15 0.20 (at 20°C, 120Hz)
Low Temperature Characteristics (Max. Impedance Ratio)	Rated voltage (V _{dc})	160 to 400V 420 to 500V
	Z(-25°C)/Z(+20°C)	4 8 (at 120Hz)
Endurance	The following specifications shall be satisfied when the capacitors are restored to 20°C after subjected to DC voltage with the rated ripple current is applied (the peak voltage shall not exceed the rated voltage) for 3,000 hours at 105°C.	
	Capacitance change	≤ ±20% of the initial value
	D.F. (tanδ)	≤ 200% of the initial specified value
Shelf Life	The following specifications shall be satisfied when the capacitors are restored to 20°C after exposing them for 1,000 hours at 105°C without voltage applied. Before the measurement, the capacitor shall be preconditioned by applying voltage according to Item 4.1 of JIS C 5101-4.	
	Capacitance change	≤ ±15% of the initial value
	D.F. (tanδ)	≤ 150% of the initial specified value
	Leakage current	≤ The initial specified value

◆ DIMENSIONS [mm]

- Terminal Code : VS (φ22 to φ35) : Standard

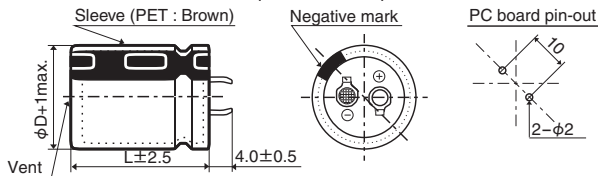

- Terminal Code : LI (φ35)

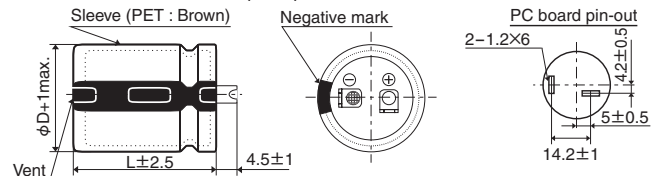

The standard design has no plastic disc.

◆ PART NUMBERING SYSTEM

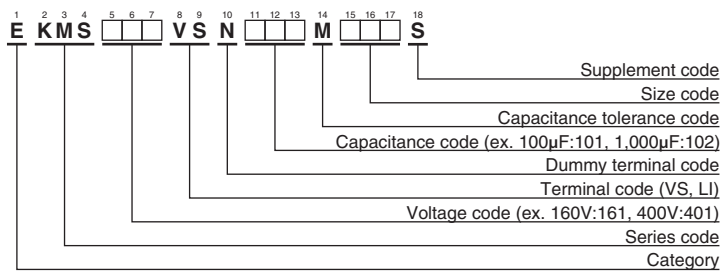

Please refer to "Product code guide (snap-in type)"

◆STANDARD RATINGS

WV (Vdc)	Cap (μF)	Case size φD×L(mm)	tanδ	Rated ripple current (Arms/105°C, 120Hz)	Part No.	WV (Vdc)	Cap (μF)	Case size φD×L(mm)	tanδ	Rated ripple current (Arms/105°C, 120Hz)	Part No.
160	470	22×25	0.15	1.47	EKMS161VSN471MP25S	200	1,800	30×45	0.15	3.66	EKMS201VSN182MR45S
	680	22×30	0.15	1.86	EKMS161VSN681MP30S		1,800	30×50	0.15	3.72	EKMS201VSN182MR50S
	680	25.4×25	0.15	1.84	EKMS161VSN681MQ25S		1,800	35×40	0.15	3.81	EKMS201VSN182MA40S
	820	22×35	0.15	2.09	EKMS161VSN821MP35S		2,200	35×45	0.15	4.32	EKMS201VSN222MA45S
	820	25.4×30	0.15	2.08	EKMS161VSN821MQ30S		2,700	35×50	0.15	4.88	EKMS201VSN272MA50S
	1,000	22×40	0.15	2.35	EKMS161VSN102MP40S		270	22×25	0.15	1.11	EKMS251VSN271MP25S
	1,000	22×45	0.15	2.40	EKMS161VSN102MP45S		330	22×30	0.15	1.29	EKMS251VSN271MP30S
	1,000	25.4×35	0.15	2.40	EKMS161VSN102MQ35S		390	22×35	0.15	1.44	EKMS251VSN391MP35S
	1,000	30×25	0.15	2.50	EKMS161VSN102MR25S		390	25.4×25	0.15	1.40	EKMS251VSN391MQ25S
	1,200	22×50	0.15	2.69	EKMS161VSN122MP50S		470	22×40	0.15	1.61	EKMS251VSN471MP40S
	1,200	25.4×40	0.15	2.68	EKMS161VSN122MQ40S		470	25.4×30	0.15	1.57	EKMS251VSN471MQ30S
	1,200	30×30	0.15	2.77	EKMS161VSN122MR30S		560	22×45	0.15	1.79	EKMS251VSN561MP45S
	1,200	35×25	0.15	2.91	EKMS161VSN122MA25S		560	25.4×35	0.15	1.79	EKMS251VSN561MQ35S
	1,500	25.4×45	0.15	3.05	EKMS161VSN152MQ45S		560	30×25	0.15	1.87	EKMS251VSN561MR25S
	1,500	30×35	0.15	3.17	EKMS161VSN152MR35S		680	22×50	0.15	2.02	EKMS251VSN681MP50S
	1,800	25.4×50	0.15	3.40	EKMS161VSN182MQ50S		680	25.4×40	0.15	2.02	EKMS251VSN681MQ40S
	1,800	30×40	0.15	3.57	EKMS161VSN182MR40S		680	30×30	0.15	2.08	EKMS251VSN681MR30S
	1,800	35×30	0.15	3.62	EKMS161VSN182MA30S		680	35×25	0.15	2.19	EKMS251VSN681MA25S
	2,200	30×45	0.15	4.05	EKMS161VSN222MR45S		820	25.4×45	0.15	2.26	EKMS251VSN821MQ45S
	2,200	35×35	0.15	4.07	EKMS161VSN222MA35S		820	30×35	0.15	2.34	EKMS251VSN821MR35S
2,700	30×50	0.15	4.56	EKMS161VSN272MR50S	1,000	25.4×50	0.15	2.53	EKMS251VSN102MQ50S		
2,700	35×40	0.15	4.67	EKMS161VSN272MA40S	1,000	30×40	0.15	2.66	EKMS251VSN102MR40S		
2,700	35×45	0.15	4.78	EKMS161VSN272MA45S	1,000	35×30	0.15	2.70	EKMS251VSN102MA30S		
3,300	35×50	0.15	5.40	EKMS161VSN332MA50S	1,200	30×45	0.15	2.99	EKMS251VSN122MR45S		
180	390	22×25	0.15	1.34	EKMS181VSN391MP25S	1,200	30×50	0.15	3.04	EKMS251VSN122MR50S	
	560	22×30	0.15	1.68	EKMS181VSN561MP30S	1,200	35×35	0.15	3.00	EKMS251VSN122MA35S	
	560	25.4×25	0.15	1.67	EKMS181VSN561MQ25S	1,500	35×40	0.15	3.48	EKMS251VSN152MA40S	
	680	22×35	0.15	1.90	EKMS181VSN681MP35S	1,500	35×45	0.15	3.56	EKMS251VSN152MA45S	
	820	22×40	0.15	2.13	EKMS181VSN821MP40S	1,800	35×50	0.15	3.98	EKMS251VSN182MA50S	
	820	25.4×30	0.15	2.08	EKMS181VSN821MQ30S	180	22×25	0.15	0.95	EKMS3B1VSN181MP25S	
	820	30×25	0.15	2.26	EKMS181VSN821MR25S	220	22×30	0.15	1.10	EKMS3B1VSN221MP30S	
	1,000	22×45	0.15	2.40	EKMS181VSN102MP45S	220	25.4×25	0.15	1.10	EKMS3B1VSN221MQ25S	
	1,000	22×50	0.15	2.45	EKMS181VSN102MP50S	270	22×35	0.15	1.24	EKMS3B1VSN271MP35S	
	1,000	25.4×35	0.15	2.40	EKMS181VSN102MQ35S	330	22×40	0.15	1.40	EKMS3B1VSN331MP40S	
	1,000	25.4×40	0.15	2.45	EKMS181VSN102MQ40S	330	25.4×30	0.15	1.38	EKMS3B1VSN331MQ30S	
	1,000	30×30	0.15	2.52	EKMS181VSN102MR30S	330	30×25	0.15	1.43	EKMS3B1VSN331MR25S	
	1,200	25.4×45	0.15	2.73	EKMS181VSN122MQ45S	390	22×45	0.15	1.56	EKMS3B1VSN391MP45S	
	1,200	30×35	0.15	2.83	EKMS181VSN122MR35S	390	22×50	0.15	1.59	EKMS3B1VSN391MP50S	
	1,200	35×25	0.15	2.91	EKMS181VSN122MA25S	390	25.4×35	0.15	1.57	EKMS3B1VSN391MQ35S	
	1,500	25.4×50	0.15	3.10	EKMS181VSN152MQ50S	470	25.4×40	0.15	1.76	EKMS3B1VSN471MQ40S	
	1,500	30×40	0.15	3.26	EKMS181VSN152MR40S	470	30×30	0.15	1.73	EKMS3B1VSN471MR30S	
	1,500	35×30	0.15	3.31	EKMS181VSN152MA30S	470	35×25	0.15	1.82	EKMS3B1VSN471MA25S	
	1,800	30×45	0.15	3.66	EKMS181VSN182MR45S	560	25.4×45	0.15	1.96	EKMS3B1VSN561MQ45S	
	1,800	35×35	0.15	3.68	EKMS181VSN182MA35S	560	25.4×50	0.15	1.99	EKMS3B1VSN561MQ50S	
2,200	30×50	0.15	4.11	EKMS181VSN222MR50S	560	30×35	0.15	1.93	EKMS3B1VSN561MR35S		
2,200	35×40	0.15	4.22	EKMS181VSN222MA40S	560	35×30	0.15	2.02	EKMS3B1VSN561MA30S		
2,700	35×45	0.15	4.78	EKMS181VSN272MA45S	680	30×40	0.15	2.19	EKMS3B1VSN681MR40S		
2,700	35×50	0.15	4.88	EKMS181VSN272MA50S	680	35×35	0.15	2.26	EKMS3B1VSN681MA35S		
200	390	22×25	0.15	1.34	EKMS201VSN391MP25S	820	30×45	0.15	2.47	EKMS3B1VSN821MR45S	
	470	22×30	0.15	1.54	EKMS201VSN471MP30S	820	30×50	0.15	2.51	EKMS3B1VSN821MR50S	
	560	22×35	0.15	1.72	EKMS201VSN561MP35S	820	35×40	0.15	2.57	EKMS3B1VSN821MA40S	
	560	25.4×25	0.15	1.67	EKMS201VSN561MQ25S	1,000	35×45	0.15	2.91	EKMS3B1VSN102MA45S	
	680	22×40	0.15	1.94	EKMS201VSN681MP40S	1,200	35×50	0.15	3.25	EKMS3B1VSN122MA50S	
	680	25.4×30	0.15	1.89	EKMS201VSN681MQ30S	120	22×25	0.15	0.77	EKMS401VSN121MP25S	
	820	22×45	0.15	2.17	EKMS201VSN821MP45S	150	22×30	0.15	0.90	EKMS401VSN151MP30S	
	820	25.4×35	0.15	2.17	EKMS201VSN821MQ35S	180	22×35	0.15	1.02	EKMS401VSN181MP35S	
	820	30×25	0.15	2.26	EKMS201VSN821MR25S	180	25.4×25	0.15	0.99	EKMS401VSN181MQ25S	
	1,000	22×50	0.15	2.45	EKMS201VSN102MP50S	220	22×40	0.15	1.15	EKMS401VSN221MP40S	
	1,000	25.4×40	0.15	2.45	EKMS201VSN102MQ40S	220	25.4×30	0.15	1.13	EKMS401VSN221MQ30S	
	1,000	30×30	0.15	2.52	EKMS201VSN102MR30S	270	22×45	0.15	1.29	EKMS401VSN271MP45S	
	1,000	35×25	0.15	2.66	EKMS201VSN102MA25S	270	25.4×35	0.15	1.30	EKMS401VSN271MQ35S	
	1,200	25.4×45	0.15	2.73	EKMS201VSN122MQ45S	270	30×25	0.15	1.29	EKMS401VSN271MR25S	
	1,200	25.4×50	0.15	2.78	EKMS201VSN122MQ50S	330	22×50	0.15	1.47	EKMS401VSN331MP50S	
	1,200	30×35	0.15	2.83	EKMS201VSN122MR35S	330	25.4×40	0.15	1.47	EKMS401VSN331MQ40S	
	1,200	35×30	0.15	2.96	EKMS201VSN122MA30S	330	30×30	0.15	1.45	EKMS401VSN331MR30S	
	1,500	30×40	0.15	3.26	EKMS201VSN152MR40S	330	35×25	0.15	1.52	EKMS401VSN331MA25S	
	1,500	35×35	0.15	3.36	EKMS201VSN152MA35S	390	25.4×45	0.15	1.63	EKMS401VSN391MQ45S	

◆STANDARD RATINGS

WV (V _{dc})	Cap (μF)	Case size φD×L(mm)	tanδ	Rated ripple current (Arms/105°C, 120Hz)	Part No.	WV (V _{dc})	Cap (μF)	Case size φD×L(mm)	tanδ	Rated ripple current (Arms/105°C, 120Hz)	Part No.	
400	390	25.4×50	0.15	1.66	EKMS401VSN391MQ50S	450	180	25.4×35	0.20	1.06	EKMS451VSN181MQ35S	
	390	30×35	0.15	1.61	EKMS401VSN391MR35S		180	30×25	0.20	1.06	EKMS451VSN181MR25S	
	470	30×40	0.15	1.82	EKMS401VSN471MR40S		220	22×50	0.20	1.20	EKMS451VSN221MP50S	
	470	35×30	0.15	1.85	EKMS401VSN471MA30S		220	25.4×40	0.20	1.20	EKMS451VSN221MQ40S	
	560	30×45	0.15	2.04	EKMS401VSN561MR45S		220	30×30	0.20	1.18	EKMS451VSN221MR30S	
	560	30×50	0.15	2.07	EKMS401VSN561MR50S		220	35×25	0.20	1.24	EKMS451VSN221MA25S	
	560	35×35	0.15	2.05	EKMS401VSN561MA35S		270	25.4×45	0.20	1.36	EKMS451VSN271MQ45S	
	680	35×40	0.15	2.34	EKMS401VSN681MA40S		270	25.4×50	0.20	1.38	EKMS451VSN271MQ50S	
	680	35×45	0.15	2.40	EKMS401VSN681MA45S		270	30×35	0.20	1.34	EKMS451VSN271MR35S	
	820	35×50	0.15	2.69	EKMS401VSN821MA50S		270	35×30	0.20	1.40	EKMS451VSN271MA30S	
420	100	22×25	0.20	0.70	EKMS421VSN101MP25S	450	330	30×40	0.20	1.52	EKMS451VSN331MQ40S	
	120	22×30	0.20	0.81	EKMS421VSN121MP30S		390	30×45	0.20	1.70	EKMS451VSN391MR45S	
	120	25.4×25	0.20	0.81	EKMS421VSN121MQ25S		390	30×50	0.20	1.73	EKMS451VSN391MR50S	
	150	22×35	0.20	0.93	EKMS421VSN151MP35S		390	35×35	0.20	1.71	EKMS451VSN391MA35S	
	180	22×40	0.20	1.04	EKMS421VSN181MP40S		470	35×40	0.20	1.95	EKMS451VSN471MA40S	
	180	25.4×30	0.20	1.02	EKMS421VSN181MQ30S		470	35×45	0.20	1.99	EKMS451VSN471MA45S	
	180	30×25	0.20	1.06	EKMS421VSN181MR25S		560	35×50	0.20	2.22	EKMS451VSN561MA50S	
	220	22×45	0.20	1.17	EKMS421VSN221MP45S		500	47	22×25	0.20	0.51	EKMS501VSN470MP25S
	220	22×50	0.20	1.20	EKMS421VSN221MP50S			56	22×30	0.20	0.58	EKMS501VSN560MP30S
	220	25.4×35	0.20	1.18	EKMS421VSN221MQ35S			68	25.4×25	0.20	0.65	EKMS501VSN680MQ25S
	220	30×30	0.20	1.18	EKMS421VSN221MR30S	82		22×35	0.20	0.72	EKMS501VSN820MP35S	
	270	25.4×40	0.20	1.33	EKMS421VSN271MQ40S	82		25.4×30	0.20	0.74	EKMS501VSN820MQ30S	
	270	25.4×45	0.20	1.36	EKMS421VSN271MQ45S	100		22×45	0.20	0.83	EKMS501VSN101MP45S	
	270	35×25	0.20	1.38	EKMS421VSN271MA25S	100		30×25	0.20	0.82	EKMS501VSN101MR25S	
	330	25.4×50	0.20	1.52	EKMS421VSN331MQ50S	120		22×50	0.20	0.93	EKMS501VSN121MP50S	
	330	30×35	0.20	1.48	EKMS421VSN331MR35S	120		25.4×35	0.20	0.93	EKMS501VSN121MQ35S	
	330	30×40	0.20	1.52	EKMS421VSN331MR40S	120		30×30	0.20	0.91	EKMS501VSN121MR30S	
	330	35×30	0.20	1.55	EKMS421VSN331MA30S	150	25.4×45	0.20	1.08	EKMS501VSN151MQ45S		
	390	30×45	0.20	1.70	EKMS421VSN391MR45S	150	30×35	0.20	1.04	EKMS501VSN151MR35S		
	390	35×35	0.20	1.71	EKMS421VSN391MA35S	150	35×25	0.20	0.99	EKMS501VSN151MA25S		
470	30×50	0.20	1.90	EKMS421VSN471MR50S	180	25.4×50	0.20	1.20	EKMS501VSN181MQ50S			
470	35×40	0.20	1.95	EKMS421VSN471MA40S	180	30×40	0.20	1.17	EKMS501VSN181MR40S			
560	35×45	0.20	2.17	EKMS421VSN561MA45S	180	35×30	0.20	1.10	EKMS501VSN181MA30S			
680	35×50	0.20	2.45	EKMS421VSN681MA50S	220	30×45	0.20	1.33	EKMS501VSN221MR45S			
450	82	22×25	0.20	0.64	EKMS451VSN820MP25S	220	35×35	0.20	1.23	EKMS501VSN221MA35S		
	120	22×30	0.20	0.81	EKMS451VSN121MP30S	270	30×50	0.20	1.50	EKMS501VSN271MR50S		
	120	22×35	0.20	0.83	EKMS451VSN121MP35S	270	35×40	0.20	1.42	EKMS501VSN271MA40S		
	120	25.4×25	0.20	0.81	EKMS451VSN121MQ25S	330	35×45	0.20	1.60	EKMS501VSN331MA45S		
	150	22×40	0.20	0.94	EKMS451VSN151MP40S	390	35×50	0.20	1.78	EKMS501VSN391MA50S		
	150	25.4×30	0.20	0.93	EKMS451VSN151MQ30S	470	35×60	0.20	2.03	EKMS501VSN471MA60S		
	180	22×45	0.20	1.06	EKMS451VSN181MP45S							

◆RATED RIPPLE CURRENT MULTIPLIERS

●Frequency Multipliers

Frequency(Hz)	50	120	300	1k	10k	50k
160 to 250V _{dc}	0.81	1.00	1.17	1.32	1.45	1.50
315 to 450V _{dc}	0.77	1.00	1.16	1.30	1.41	1.43
500V _{dc}	0.70	1.00	1.16	1.30	1.41	1.43

The endurance of capacitors is reduced with internal heating produced by ripple current at the rate of halving the lifetime with every 5°C rise.

When long life performance is required in actual use, the rms ripple current has to be reduced.

KMM Series

- Longer life from KMQ series
- Endurance with ripple current : 2,000 to 3,000 hours at 105°C
- Non solvent resistant type
- RoHS Compliant

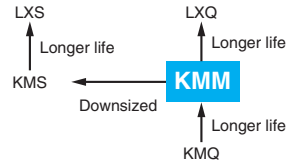

SPECIFICATIONS

Items	Characteristics		
Category	Temperature Range		
Temperature Range	-25 to +105°C		
Rated Voltage Range	160 to 450V _{dc}		
Capacitance Tolerance	±20% (M) (at 20°C, 120Hz)		
Leakage Current	$I \leq 3\sqrt{CV}$ Where, I : Max. leakage current (µA), C : Nominal capacitance (µF), V : Rated voltage (V) (at 20°C after 5 minutes)		
Dissipation Factor (tanδ)	Rated voltage (V _{dc})	160 to 400V	420 & 450V
	tanδ (Max.)	0.15	0.20
Low Temperature Characteristics (Max. Impedance Ratio)	Rated voltage (V _{dc})	160 to 400V	420 & 450V
	Z(-25°C)/Z(+20°C)	4	8
Endurance	The following specifications shall be satisfied when the capacitors are restored to 20°C after subjected to DC voltage with the rated ripple current is applied (the peak voltage shall not exceed the rated voltage) for 3,000 hours (2,000 hours for φ20×20L products) at 105°C.		
	Capacitance change	≤±20% of the initial value	
	D.F. (tanδ)	≤200% of the initial specified value	
	Leakage current	≤The initial specified value	
Shelf Life	The following specifications shall be satisfied when the capacitors are restored to 20°C after exposing them for 1,000 hours at 105°C without voltage applied. Before the measurement, the capacitor shall be preconditioned by applying voltage according to Item 4.1 of JIS C 5101-4.		
	Capacitance change	≤±15% of the initial value	
	D.F. (tanδ)	≤150% of the initial specified value	
	Leakage current	≤The initial specified value	

DIMENSIONS [mm]

- Terminal Code : VS (φ20 to φ35) : Standard

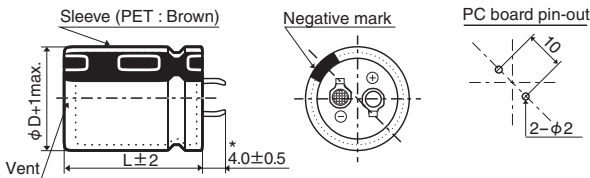

- Terminal Code : LI (φ35)

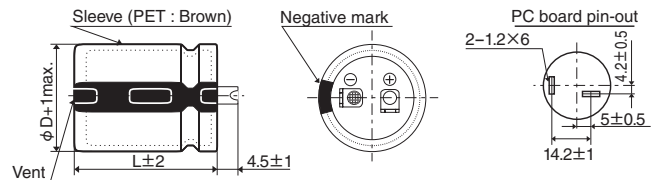

* φD=35mm : 3.5±0.5mm

The standard design has no plastic disc.

PART NUMBERING SYSTEM

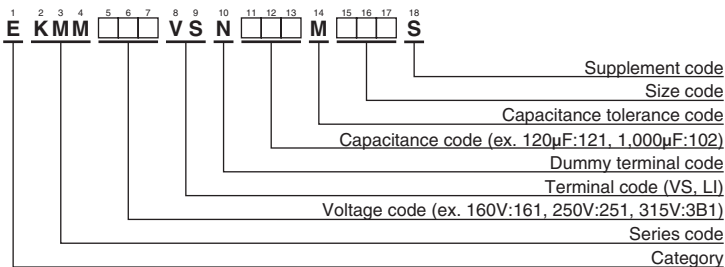

Please refer to "Product code guide (snap-in type)"



KMM Series

◆STANDARD RATINGS

WV (Vdc)	Cap (μF)	Case size φD×L(mm)	tanδ	Rated ripple current (Arms/105°C,120Hz)	Part No.	WV (Vdc)	Cap (μF)	Case size φD×L(mm)	tanδ	Rated ripple current (Arms/105°C,120Hz)	Part No.
160	180	20×20	0.15	0.68	EKMM161VSN181MN20S	180	560	20×45	0.15	1.55	EKMM181VSN561MN45S
	220	20×25	0.15	0.85	EKMM161VSN221MN25S		560	22×40	0.15	1.67	EKMM181VSN561MP40S
	220	22×20	0.15	0.81	EKMM161VSN221MP20S		560	25.4×30	0.15	1.67	EKMM181VSN561MQ30S
	270	20×25	0.15	1.10	EKMM161VSN271MN25S		560	30×25	0.15	1.67	EKMM181VSN561MR25S
	270	25.4×20	0.15	0.98	EKMM161VSN271MQ20S		560	35×20	0.15	1.43	EKMM181VSN561MA20S
	330	20×30	0.15	1.20	EKMM161VSN331MN30S		680	20×50	0.15	1.75	EKMM181VSN681MN50S
	330	22×25	0.15	1.20	EKMM161VSN331MP25S		680	22×45	0.15	1.78	EKMM181VSN681MP45S
	330	25.4×20	0.15	1.02	EKMM161VSN331MQ20S		680	25.4×35	0.15	1.78	EKMM181VSN681MQ35S
	390	20×30	0.15	1.30	EKMM161VSN391MN30S		680	30×30	0.15	1.78	EKMM181VSN681MR30S
	390	22×25	0.15	1.30	EKMM161VSN391MP25S		680	35×25	0.15	1.83	EKMM181VSN681MA25S
	390	25.4×25	0.15	1.26	EKMM161VSN391MQ25S		820	22×50	0.15	2.04	EKMM181VSN821MP50S
	390	30×20	0.15	1.25	EKMM161VSN391MR20S		820	25.4×40	0.15	2.04	EKMM181VSN821MQ40S
	470	20×35	0.15	1.34	EKMM161VSN471MN35S		820	30×30	0.15	2.04	EKMM181VSN821MR30S
	470	22×30	0.15	1.55	EKMM161VSN471MP30S		820	35×25	0.15	2.04	EKMM181VSN821MA25S
	470	25.4×25	0.15	1.55	EKMM161VSN471MQ25S		1,000	25.4×45	0.15	2.30	EKMM181VSN102MQ45S
	470	30×20	0.15	1.30	EKMM161VSN471MR20S		1,000	30×35	0.15	2.30	EKMM181VSN102MR35S
	560	20×40	0.15	1.50	EKMM161VSN561MN40S		1,000	35×30	0.15	2.30	EKMM181VSN102MA30S
	560	22×35	0.15	1.67	EKMM161VSN561MP35S		1,200	25.4×50	0.15	2.55	EKMM181VSN122MQ50S
	560	25.4×30	0.15	1.67	EKMM161VSN561MQ30S		1,200	30×40	0.15	2.55	EKMM181VSN122MR40S
	560	30×25	0.15	1.67	EKMM161VSN561MR25S		1,200	35×30	0.15	2.55	EKMM181VSN122MA30S
	560	35×20	0.15	1.46	EKMM161VSN561MA20S		1,500	30×45	0.15	2.90	EKMM181VSN152MR45S
	680	20×45	0.15	1.70	EKMM161VSN681MN45S		1,500	35×35	0.15	2.90	EKMM181VSN152MA35S
	680	22×40	0.15	1.82	EKMM161VSN681MP40S		1,800	30×60	0.15	3.49	EKMM181VSN182MR60S
	680	25.4×30	0.15	1.82	EKMM161VSN681MQ30S		1,800	35×40	0.15	3.30	EKMM181VSN182MA40S
	680	30×25	0.15	1.82	EKMM161VSN681MR25S		2,200	35×50	0.15	3.65	EKMM181VSN222MA50S
	680	35×20	0.15	1.51	EKMM161VSN681MA20S		2,700	35×60	0.15	4.19	EKMM181VSN272MA60S
	820	22×45	0.15	2.04	EKMM161VSN821MP45S		120	20×20	0.15	0.56	EKMM201VSN121MN20S
	820	25.4×35	0.15	2.04	EKMM161VSN821MQ35S		150	20×25	0.15	0.71	EKMM201VSN151MN25S
	820	30×30	0.15	2.04	EKMM161VSN821MR30S		150	22×20	0.15	0.73	EKMM201VSN151MP20S
	820	35×25	0.15	2.04	EKMM161VSN821MA25S		180	20×25	0.15	0.77	EKMM201VSN181MN25S
	1,000	22×50	0.15	2.25	EKMM161VSN102MP50S		180	22×20	0.15	0.80	EKMM201VSN181MP20S
	1,000	25.4×40	0.15	2.25	EKMM161VSN102MQ40S		220	20×25	0.15	1.00	EKMM201VSN221MN25S
	1,000	30×30	0.15	2.25	EKMM161VSN102MR30S		220	25.4×20	0.15	0.85	EKMM201VSN221MQ20S
	1,000	35×25	0.15	2.25	EKMM161VSN102MA25S		270	20×30	0.15	1.10	EKMM201VSN271MN30S
	1,200	25.4×45	0.15	2.49	EKMM161VSN122MQ45S		270	22×25	0.15	1.10	EKMM201VSN271MP25S
	1,200	30×35	0.15	2.49	EKMM161VSN122MR35S		270	30×20	0.15	1.05	EKMM201VSN271MR20S
	1,200	35×30	0.15	2.49	EKMM161VSN122MA30S		330	20×35	0.15	1.20	EKMM201VSN331MN35S
	1,500	25.4×60	0.15	2.97	EKMM161VSN152MQ60S		330	22×30	0.15	1.25	EKMM201VSN331MP30S
	1,500	30×40	0.15	2.84	EKMM161VSN152MR40S		330	25.4×25	0.15	1.25	EKMM201VSN331MQ25S
	1,500	35×30	0.15	2.84	EKMM161VSN152MA30S		330	30×20	0.15	1.10	EKMM201VSN331MR20S
1,800	30×45	0.15	3.32	EKMM161VSN182MR45S	390	20×40	0.15	1.31	EKMM201VSN391MN40S		
1,800	35×35	0.15	3.00	EKMM161VSN182MA35S	390	22×30	0.15	1.35	EKMM201VSN391MP30S		
2,200	30×60	0.15	3.86	EKMM161VSN222MR60S	390	25.4×25	0.15	1.35	EKMM201VSN391MQ25S		
2,200	35×45	0.15	3.50	EKMM161VSN222MA45S	390	35×20	0.15	1.30	EKMM201VSN391MA20S		
2,700	35×50	0.15	4.00	EKMM161VSN272MA50S	470	20×45	0.15	1.45	EKMM201VSN471MN45S		
3,300	35×60	0.15	4.63	EKMM161VSN332MA60S	470	22×35	0.15	1.50	EKMM201VSN471MP35S		
180	150	20×20	0.15	0.62	EKMM181VSN151MN20S	470	25.4×30	0.15	1.50	EKMM201VSN471MQ30S	
	180	20×25	0.15	0.77	EKMM181VSN181MN25S	470	30×25	0.15	1.50	EKMM201VSN471MR25S	
	180	22×20	0.15	0.80	EKMM181VSN181MP20S	470	35×20	0.15	1.41	EKMM201VSN471MA20S	
	220	20×25	0.15	1.00	EKMM181VSN221MN25S	560	20×50	0.15	1.58	EKMM201VSN561MN50S	
	220	25.4×20	0.15	0.90	EKMM181VSN221MQ20S	560	22×40	0.15	1.67	EKMM201VSN561MP40S	
	270	20×30	0.15	1.10	EKMM181VSN271MN30S	560	25.4×30	0.15	1.67	EKMM201VSN561MQ30S	
	270	22×25	0.15	1.00	EKMM181VSN271MP25S	560	30×25	0.15	1.67	EKMM201VSN561MR25S	
	270	25.4×20	0.15	0.95	EKMM181VSN271MQ20S	680	22×45	0.15	1.78	EKMM201VSN681MP45S	
	330	20×30	0.15	1.20	EKMM181VSN331MN30S	680	25.4×35	0.15	1.78	EKMM201VSN681MQ35S	
	330	22×25	0.15	1.20	EKMM181VSN331MP25S	680	30×30	0.15	1.78	EKMM201VSN681MR30S	
	330	25.4×25	0.15	1.16	EKMM181VSN331MQ25S	680	35×25	0.15	1.78	EKMM201VSN681MA25S	
	330	30×20	0.15	1.15	EKMM181VSN331MR20S	820	25.4×45	0.15	2.04	EKMM201VSN821MQ45S	
	390	20×35	0.15	1.30	EKMM181VSN391MN35S	820	30×30	0.15	2.04	EKMM201VSN821MR30S	
	390	22×30	0.15	1.35	EKMM181VSN391MP30S	820	35×25	0.15	2.04	EKMM201VSN821MA25S	
	390	25.4×25	0.15	1.35	EKMM181VSN391MQ25S	1,000	25.4×50	0.15	2.30	EKMM201VSN102MQ50S	
	390	30×20	0.15	1.20	EKMM181VSN391MR20S	1,000	30×35	0.15	2.30	EKMM201VSN102MR35S	
	470	20×40	0.15	1.40	EKMM181VSN471MN40S	1,000	35×30	0.15	2.30	EKMM201VSN102MA30S	
	470	22×35	0.15	1.50	EKMM181VSN471MP35S	1,200	25.4×60	0.15	2.66	EKMM201VSN122MQ60S	
	470	25.4×30	0.15	1.50	EKMM181VSN471MQ30S	1,200	30×40	0.15	2.65	EKMM201VSN122MR40S	
	470	30×25	0.15	1.50	EKMM181VSN471MR25S	1,200	35×35	0.15	2.65	EKMM201VSN122MA35S	
470	35×20	0.15	1.36	EKMM181VSN471MA20S	1,500	30×50	0.15	3.08	EKMM201VSN152MR50S		

Product specifications in this catalog are subject to change without notice. Request our product specifications before purchase and/or use. Please use our products based on the information contained in this catalog and product specifications.

◆STANDARD RATINGS

WV (Vdc)	Cap (μF)	Case size φD×L(mm)	tanδ	Rated ripple current (Arms/105°C, 120Hz)	Part No.	WV (Vdc)	Cap (μF)	Case size φD×L(mm)	tanδ	Rated ripple current (Arms/105°C, 120Hz)	Part No.	
200	1,500	35×40	0.15	3.08	EKMM201VSN152MA40S	250	330	30×25	0.15	1.30	EKMM251VSN331MR25S	
	1,800	30×60	0.15	3.49	EKMM201VSN182MR60S		330	35×20	0.15	1.16	EKMM251VSN331MA20S	
	1,800	35×45	0.15	3.48	EKMM201VSN182MA45S		390	20×50	0.15	1.45	EKMM251VSN391MN50S	
	2,200	35×50	0.15	3.78	EKMM201VSN222MA50S		390	22×40	0.15	1.49	EKMM251VSN391MP40S	
220	120	20×20	0.15	0.56	EKMM221VSN121MN20S		390	25.4×35	0.15	1.49	EKMM251VSN391MQ35S	
	150	20×25	0.15	0.73	EKMM221VSN151MN25S		390	30×25	0.15	1.49	EKMM251VSN391MR25S	
	150	22×20	0.15	0.67	EKMM221VSN151MP20S		470	22×45	0.15	1.65	EKMM251VSN471MP45S	
	180	20×25	0.15	0.90	EKMM221VSN181MN25S		470	25.4×35	0.15	1.65	EKMM251VSN471MQ35S	
	180	25.4×20	0.15	0.76	EKMM221VSN181MQ20S		470	30×30	0.15	1.65	EKMM251VSN471MR30S	
	220	20×30	0.15	1.00	EKMM221VSN221MN30S		470	35×25	0.15	1.65	EKMM251VSN471MA25S	
	220	22×25	0.15	1.00	EKMM221VSN221MP25S		560	22×50	0.15	1.67	EKMM251VSN561MP50S	
	220	25.4×20	0.15	0.84	EKMM221VSN221MQ20S		560	25.4×40	0.15	1.80	EKMM251VSN561MQ40S	
	270	20×35	0.15	1.15	EKMM221VSN271MN35S		560	30×30	0.15	1.80	EKMM251VSN561MR30S	
	270	22×30	0.15	1.15	EKMM221VSN271MP30S		560	35×25	0.15	1.80	EKMM251VSN561MA25S	
	270	25.4×25	0.15	1.08	EKMM221VSN271MQ25S		680	25.4×50	0.15	2.00	EKMM251VSN681MQ50S	
	270	30×20	0.15	0.98	EKMM221VSN271MR20S		680	30×35	0.15	2.00	EKMM251VSN681MR35S	
	330	20×40	0.15	1.25	EKMM221VSN331MN40S		680	35×30	0.15	2.00	EKMM251VSN681MA30S	
	330	22×35	0.15	1.25	EKMM221VSN331MP35S		820	25.4×60	0.15	2.20	EKMM251VSN821MQ60S	
	330	25.4×25	0.15	1.25	EKMM221VSN331MQ25S		820	30×40	0.15	2.30	EKMM251VSN821MR40S	
	330	35×20	0.15	1.13	EKMM221VSN331MA20S		820	35×35	0.15	2.30	EKMM251VSN821MA35S	
	390	20×45	0.15	1.40	EKMM221VSN391MN45S		1,000	30×50	0.15	2.47	EKMM251VSN102MR50S	
	390	22×35	0.15	1.40	EKMM221VSN391MP35S		1,000	35×40	0.15	2.47	EKMM251VSN102MA40S	
	390	25.4×30	0.15	1.40	EKMM221VSN391MQ30S		1,200	30×60	0.15	2.85	EKMM251VSN122MR60S	
	390	30×25	0.15	1.36	EKMM221VSN391MR25S		1,200	35×45	0.15	2.60	EKMM251VSN122MA45S	
	390	35×20	0.15	1.23	EKMM221VSN391MA20S		1,500	35×50	0.15	3.00	EKMM251VSN152MA50S	
	470	20×50	0.15	1.51	EKMM221VSN471MN50S		1,800	35×60	0.15	3.42	EKMM251VSN182MA60S	
	470	22×40	0.15	1.51	EKMM221VSN471MP40S		315	56	20×20	0.15	0.38	EKMM3B1VSN560MN20S
	470	25.4×35	0.15	1.54	EKMM221VSN471MQ35S			68	20×25	0.15	0.47	EKMM3B1VSN680MN25S
	470	30×25	0.15	1.50	EKMM221VSN471MR25S			68	22×20	0.15	0.45	EKMM3B1VSN680MP20S
	560	22×45	0.15	1.70	EKMM221VSN561MP45S			82	20×25	0.15	0.64	EKMM3B1VSN820MN25S
	560	25.4×40	0.15	1.72	EKMM221VSN561MQ40S			82	22×20	0.15	0.47	EKMM3B1VSN820MP20S
	560	30×30	0.15	1.70	EKMM221VSN561MR30S			100	20×30	0.15	0.69	EKMM3B1VSN101MN30S
	560	35×25	0.15	1.71	EKMM221VSN561MA25S			100	22×25	0.15	0.61	EKMM3B1VSN101MP25S
	680	25.4×45	0.15	1.94	EKMM221VSN681MQ45S			100	25.4×20	0.15	0.56	EKMM3B1VSN101MQ20S
	680	30×35	0.15	1.93	EKMM221VSN681MR35S			120	20×30	0.15	0.75	EKMM3B1VSN121MN30S
	680	35×25	0.15	1.89	EKMM221VSN681MA25S			120	22×25	0.15	0.75	EKMM3B1VSN121MP25S
	820	25.4×50	0.15	2.18	EKMM221VSN821MQ50S			120	25.4×20	0.15	0.62	EKMM3B1VSN121MQ20S
	820	30×40	0.15	2.19	EKMM221VSN821MR40S			120	30×20	0.15	0.65	EKMM3B1VSN121MR20S
	820	35×30	0.15	2.16	EKMM221VSN821MA30S			150	20×35	0.15	0.82	EKMM3B1VSN151MN35S
	1,000	25.4×60	0.15	2.54	EKMM221VSN102MQ60S			150	22×30	0.15	0.82	EKMM3B1VSN151MP30S
	1,000	30×45	0.15	2.50	EKMM221VSN102MR45S			150	25.4×25	0.15	0.82	EKMM3B1VSN151MQ25S
	1,000	35×35	0.15	2.44	EKMM221VSN102MA35S			150	30×20	0.15	0.70	EKMM3B1VSN151MR20S
	1,200	30×50	0.15	2.81	EKMM221VSN122MR50S			150	35×20	0.15	0.76	EKMM3B1VSN151MA20S
	1,200	35×40	0.15	2.79	EKMM221VSN122MA40S			180	20×40	0.15	0.90	EKMM3B1VSN181MN40S
	1,500	30×60	0.15	3.30	EKMM221VSN152MR60S			180	22×35	0.15	0.92	EKMM3B1VSN181MP35S
	1,500	35×45	0.15	3.22	EKMM221VSN152MA45S			180	25.4×25	0.15	0.92	EKMM3B1VSN181MQ25S
	1,800	35×50	0.15	3.63	EKMM221VSN182MA50S			180	30×25	0.15	0.90	EKMM3B1VSN181MR25S
	2,200	35×60	0.15	4.23	EKMM221VSN222MA60S			180	35×20	0.15	0.85	EKMM3B1VSN181MA20S
	250	100	20×20	0.15	0.51	EKMM251VSN101MN20S		220	20×50	0.15	1.00	EKMM3B1VSN221MN50S
		120	20×25	0.15	0.58	EKMM251VSN121MN25S		220	22×40	0.15	1.04	EKMM3B1VSN221MP40S
		120	22×20	0.15	0.60	EKMM251VSN121MP20S		220	25.4×30	0.15	1.04	EKMM3B1VSN221MQ30S
		150	20×25	0.15	0.79	EKMM251VSN151MN25S		220	30×25	0.15	1.04	EKMM3B1VSN221MR25S
150		25.4×20	0.15	0.74	EKMM251VSN151MQ20S	220		35×20	0.15	0.90	EKMM3B1VSN221MA20S	
180		20×30	0.15	0.90	EKMM251VSN181MN30S	270		22×45	0.15	1.16	EKMM3B1VSN271MP45S	
180		22×25	0.15	0.78	EKMM251VSN181MP25S	270		25.4×35	0.15	1.16	EKMM3B1VSN271MQ35S	
180		25.4×20	0.15	0.75	EKMM251VSN181MQ20S	270		30×25	0.15	1.16	EKMM3B1VSN271MR25S	
220		20×30	0.15	1.00	EKMM251VSN221MN30S	270		35×25	0.15	1.15	EKMM3B1VSN271MA25S	
220		22×25	0.15	1.00	EKMM251VSN221MP25S	330		22×50	0.15	1.33	EKMM3B1VSN331MP50S	
220		25.4×25	0.15	0.95	EKMM251VSN221MQ25S	330		25.4×40	0.15	1.33	EKMM3B1VSN331MQ40S	
220		30×20	0.15	0.95	EKMM251VSN221MR20S	330		30×30	0.15	1.33	EKMM3B1VSN331MR30S	
270		20×35	0.15	1.10	EKMM251VSN271MN35S	330		35×25	0.15	1.33	EKMM3B1VSN331MA25S	
270		22×30	0.15	1.18	EKMM251VSN271MP30S	390		25.4×45	0.15	1.47	EKMM3B1VSN391MQ45S	
270		25.4×25	0.15	1.18	EKMM251VSN271MQ25S	390		30×35	0.15	1.47	EKMM3B1VSN391MR35S	
270		30×20	0.15	1.00	EKMM251VSN271MR20S	390		35×30	0.15	1.47	EKMM3B1VSN391MA30S	
330		20×40	0.15	1.20	EKMM251VSN331MN40S	470		25.4×50	0.15	1.70	EKMM3B1VSN471MQ50S	
330		22×35	0.15	1.30	EKMM251VSN331MP35S	470		30×40	0.15	1.70	EKMM3B1VSN471MR40S	
330		25.4×30	0.15	1.30	EKMM251VSN331MQ30S	470		35×30	0.15	1.70	EKMM3B1VSN471MA30S	

◆STANDARD RATINGS

WV (Vdc)	Cap (μF)	Case size φD×L(mm)	tanδ	Rated ripple current (Arms/105°C, 120Hz)	Part No.	WV (Vdc)	Cap (μF)	Case size φD×L(mm)	tanδ	Rated ripple current (Arms/105°C, 120Hz)	Part No.
315	560	30×45	0.15	2.05	EKMM3B1VSN561MR45S	400	100	30×20	0.15	0.60	EKMM401VSN101MR20S
	560	35×35	0.15	2.05	EKMM3B1VSN561MA35S		120	20×40	0.15	0.75	EKMM401VSN121MN40S
	680	30×50	0.15	2.17	EKMM3B1VSN681MR50S		120	22×35	0.15	0.75	EKMM401VSN121MP35S
	680	35×40	0.15	2.17	EKMM3B1VSN681MA40S		120	25.4×25	0.15	0.75	EKMM401VSN121MQ25S
	820	35×45	0.15	2.20	EKMM3B1VSN821MA45S		120	30×25	0.15	0.73	EKMM401VSN121MR25S
	1,000	35×60	0.15	2.55	EKMM3B1VSN102MA60S		120	35×20	0.15	0.75	EKMM401VSN121MA20S
350	47	20×20	0.15	0.35	EKMM351VSN470MN20S		150	20×45	0.15	0.83	EKMM401VSN151MN45S
	56	20×25	0.15	0.43	EKMM351VSN560MN25S		150	22×40	0.15	0.88	EKMM401VSN151MP40S
	56	22×20	0.15	0.41	EKMM351VSN560MP20S		150	25.4×30	0.15	0.88	EKMM401VSN151MQ30S
	68	20×25	0.15	0.47	EKMM351VSN680MN25S		150	30×25	0.15	0.88	EKMM401VSN151MR25S
	68	25.4×20	0.15	0.46	EKMM351VSN680MQ20S		150	35×20	0.15	0.80	EKMM401VSN151MA20S
	82	20×30	0.15	0.54	EKMM351VSN820MN30S		180	22×45	0.15	0.98	EKMM401VSN181MP45S
	82	22×25	0.15	0.55	EKMM351VSN820MP25S		180	25.4×35	0.15	0.98	EKMM401VSN181MQ35S
	82	25.4×20	0.15	0.51	EKMM351VSN820MQ20S		180	30×30	0.15	0.98	EKMM401VSN181MR30S
	100	20×30	0.15	0.60	EKMM351VSN101MN30S		180	35×25	0.15	0.98	EKMM401VSN181MA25S
	100	22×25	0.15	0.69	EKMM351VSN101MP25S		220	22×50	0.15	1.10	EKMM401VSN221MP50S
	100	30×20	0.15	0.60	EKMM351VSN101MR20S		220	25.4×40	0.15	1.10	EKMM401VSN221MQ40S
	120	20×35	0.15	0.68	EKMM351VSN121MN35S		220	30×30	0.15	1.10	EKMM401VSN221MR30S
	120	22×30	0.15	0.75	EKMM351VSN121MP30S		220	35×25	0.15	1.10	EKMM401VSN221MA25S
	120	25.4×25	0.15	0.75	EKMM351VSN121MQ25S		270	25.4×45	0.15	1.22	EKMM401VSN271MQ45S
	120	30×20	0.15	0.65	EKMM351VSN121MR20S		270	30×35	0.15	1.22	EKMM401VSN271MR35S
	150	20×40	0.15	0.78	EKMM351VSN151MN40S		270	35×30	0.15	1.22	EKMM401VSN271MA30S
	150	22×35	0.15	0.82	EKMM351VSN151MP35S		330	25.4×50	0.15	1.44	EKMM401VSN331MQ50S
	150	25.4×30	0.15	0.83	EKMM351VSN151MQ30S		330	30×40	0.15	1.44	EKMM401VSN331MR40S
	150	30×25	0.15	0.82	EKMM351VSN151MR25S		330	35×30	0.15	1.44	EKMM401VSN331MA30S
	150	35×20	0.15	0.76	EKMM351VSN151MA20S		390	25.4×60	0.15	1.51	EKMM401VSN391MQ60S
	180	20×45	0.15	0.87	EKMM351VSN181MN45S		390	30×45	0.15	1.60	EKMM401VSN391MR45S
	180	22×40	0.15	0.92	EKMM351VSN181MP40S		390	35×35	0.15	1.60	EKMM401VSN391MA35S
	180	25.4×30	0.15	0.92	EKMM351VSN181MQ30S	470	30×50	0.15	1.90	EKMM401VSN471MR50S	
	180	30×25	0.15	0.90	EKMM351VSN181MR25S	470	35×40	0.15	1.90	EKMM401VSN471MA40S	
	220	20×50	0.15	1.00	EKMM351VSN221MN50S	560	30×60	0.15	2.10	EKMM401VSN561MR60S	
	220	22×45	0.15	1.05	EKMM351VSN221MP45S	560	35×45	0.15	2.12	EKMM401VSN561MA45S	
	220	25.4×35	0.15	1.04	EKMM351VSN221MQ35S	680	35×60	0.15	2.27	EKMM401VSN681MA60S	
	220	30×30	0.15	1.02	EKMM351VSN221MR30S	39	20×20	0.20	0.32	EKMM421VSN390MN20S	
	220	35×25	0.15	1.04	EKMM351VSN221MA25S	47	20×25	0.20	0.39	EKMM421VSN470MN25S	
	270	22×50	0.15	1.16	EKMM351VSN271MP50S	47	22×20	0.20	0.37	EKMM421VSN470MP20S	
	270	25.4×40	0.15	1.18	EKMM351VSN271MQ40S	56	20×25	0.20	0.51	EKMM421VSN560MN25S	
	270	30×30	0.15	1.17	EKMM351VSN271MR30S	56	25.4×20	0.20	0.42	EKMM421VSN560MQ20S	
	270	35×25	0.15	1.20	EKMM351VSN271MA25S	68	20×30	0.20	0.56	EKMM421VSN680MN30S	
	330	25.4×45	0.15	1.29	EKMM351VSN331MQ45S	68	22×25	0.20	0.50	EKMM421VSN680MP25S	
	330	30×35	0.15	1.34	EKMM351VSN331MR35S	68	25.4×20	0.20	0.46	EKMM421VSN680MQ20S	
	330	35×30	0.15	1.22	EKMM351VSN331MA30S	82	20×35	0.20	0.64	EKMM421VSN820MN35S	
390	25.4×50	0.15	1.51	EKMM351VSN391MQ50S	82	22×25	0.20	0.64	EKMM421VSN820MP25S		
390	30×40	0.15	1.51	EKMM351VSN391MR40S	82	25.4×25	0.20	0.58	EKMM421VSN820MQ25S		
390	35×35	0.15	1.47	EKMM351VSN391MA35S	82	30×20	0.20	0.53	EKMM421VSN820MR20S		
470	25.4×60	0.15	1.66	EKMM351VSN471MQ60S	100	20×35	0.20	0.70	EKMM421VSN101MN35S		
470	30×45	0.15	1.65	EKMM351VSN471MR45S	100	22×30	0.20	0.70	EKMM421VSN101MP30S		
470	35×35	0.15	1.69	EKMM351VSN471MA35S	100	25.4×25	0.20	0.70	EKMM421VSN101MQ25S		
560	30×50	0.15	1.85	EKMM351VSN561MR50S	100	30×20	0.20	0.59	EKMM421VSN101MR20S		
560	35×40	0.15	1.90	EKMM351VSN561MA40S	120	20×40	0.20	0.75	EKMM421VSN121MN40S		
680	30×60	0.15	2.15	EKMM351VSN681MR60S	120	22×35	0.20	0.75	EKMM421VSN121MP35S		
680	35×50	0.15	1.99	EKMM351VSN681MA50S	120	25.4×30	0.20	0.75	EKMM421VSN121MQ30S		
820	35×60	0.15	2.31	EKMM351VSN821MA60S	120	30×25	0.20	0.73	EKMM421VSN121MR25S		
400	39	20×20	0.15	0.32	EKMM401VSN390MN20S	120	35×20	0.20	0.67	EKMM421VSN121MA20S	
	47	20×25	0.15	0.39	EKMM401VSN470MN25S	150	20×50	0.20	0.88	EKMM421VSN151MN50S	
	47	22×20	0.15	0.37	EKMM401VSN470MP20S	150	22×40	0.20	0.88	EKMM421VSN151MP40S	
	56	20×25	0.15	0.51	EKMM401VSN560MN25S	150	25.4×35	0.20	0.88	EKMM421VSN151MQ35S	
	56	25.4×20	0.15	0.42	EKMM401VSN560MQ20S	150	30×25	0.20	0.88	EKMM421VSN151MR25S	
	68	20×30	0.15	0.56	EKMM401VSN680MN30S	180	22×45	0.20	0.95	EKMM421VSN181MP45S	
	68	22×25	0.15	0.50	EKMM401VSN680MP25S	180	25.4×35	0.20	0.95	EKMM421VSN181MQ35S	
	68	25.4×20	0.15	0.46	EKMM401VSN680MQ20S	180	30×30	0.20	0.95	EKMM421VSN181MR30S	
	82	20×30	0.15	0.64	EKMM401VSN820MN30S	180	35×25	0.20	0.94	EKMM421VSN181MA25S	
	82	22×25	0.15	0.64	EKMM401VSN820MP25S	220	22×50	0.20	1.10	EKMM421VSN221MP50S	
	82	30×20	0.15	0.55	EKMM401VSN820MR20S	220	25.4×45	0.20	1.10	EKMM421VSN221MQ45S	
	100	20×35	0.15	0.70	EKMM401VSN101MN35S	220	30×35	0.20	1.10	EKMM421VSN221MR35S	
	100	22×30	0.15	0.70	EKMM401VSN101MP30S	220	35×25	0.20	1.10	EKMM421VSN221MA25S	
	100	25.4×25	0.15	0.70	EKMM401VSN101MQ25S	270	25.4×50	0.20	1.22	EKMM421VSN271MQ50S	

◆STANDARD RATINGS

WV (Vdc)	Cap (μF)	Case size φD×L(mm)	tanδ	Rated ripple current (Arms/105°C,120Hz)	Part No.	WV (Vdc)	Cap (μF)	Case size φD×L(mm)	tanδ	Rated ripple current (Arms/105°C,120Hz)	Part No.
420	270	30×40	0.20	1.22	EKMM421VSN271MR40S	450	120	20×50	0.20	0.75	EKMM451VSN121MN50S
	270	35×30	0.20	1.22	EKMM421VSN271MA30S		120	22×40	0.20	0.80	EKMM451VSN121MP40S
	330	25.4×60	0.20	1.41	EKMM421VSN331MQ60S		120	25.4×30	0.20	0.80	EKMM451VSN121MQ30S
	330	30×45	0.20	1.45	EKMM421VSN331MR45S		120	30×25	0.20	0.80	EKMM451VSN121MR25S
	330	35×35	0.20	1.45	EKMM421VSN331MA35S		120	35×25	0.20	0.73	EKMM451VSN121MA25S
	390	30×50	0.20	1.55	EKMM421VSN391MR50S		150	22×45	0.20	0.88	EKMM451VSN151MP45S
	390	35×40	0.20	1.55	EKMM421VSN391MA40S		150	25.4×35	0.20	0.88	EKMM451VSN151MQ35S
	470	30×60	0.20	1.79	EKMM421VSN471MR60S		150	30×30	0.20	0.88	EKMM451VSN151MR30S
	470	35×45	0.20	1.90	EKMM421VSN471MA45S		150	35×25	0.20	0.75	EKMM451VSN151MA25S
	560	35×50	0.20	2.15	EKMM421VSN561MA50S		180	22×50	0.20	1.00	EKMM451VSN181MP50S
680	35×60	0.20	2.27	EKMM421VSN681MA60S	180		25.4×40	0.20	1.00	EKMM451VSN181MQ40S	
450	39	20×25	0.20	0.34	EKMM451VSN390MN25S		180	30×30	0.20	1.00	EKMM451VSN181MR30S
	47	20×25	0.20	0.39	EKMM451VSN470MN25S		220	25.4×45	0.20	1.12	EKMM451VSN221MA45S
	56	20×30	0.20	0.51	EKMM451VSN560MN30S		220	30×35	0.20	1.12	EKMM451VSN221MR35S
	56	22×25	0.20	0.40	EKMM451VSN560MP25S		220	35×30	0.20	1.12	EKMM451VSN221MA30S
	68	20×35	0.20	0.56	EKMM451VSN680MN35S		270	25.4×60	0.20	1.18	EKMM451VSN271MQ60S
	68	22×30	0.20	0.53	EKMM451VSN680MP30S		270	30×40	0.20	1.28	EKMM451VSN271MR40S
	68	25.4×25	0.20	0.50	EKMM451VSN680MQ25S		270	35×35	0.20	1.28	EKMM451VSN271MA35S
	82	20×35	0.20	0.64	EKMM451VSN820MN35S		330	30×50	0.20	1.45	EKMM451VSN331MR50S
	82	22×30	0.20	0.64	EKMM451VSN820MP30S		330	35×40	0.20	1.45	EKMM451VSN331MA40S
	82	25.4×25	0.20	0.64	EKMM451VSN820MQ25S	390	30×60	0.20	1.51	EKMM451VSN391MR60S	
	100	20×45	0.20	0.69	EKMM451VSN101MN45S	390	35×40	0.20	1.55	EKMM451VSN391MA40S	
	100	22×35	0.20	0.69	EKMM451VSN101MP35S	470	35×50	0.20	1.85	EKMM451VSN471MA50S	
	100	25.4×30	0.20	0.69	EKMM451VSN101MQ30S	560	35×60	0.20	1.91	EKMM451VSN561MA60S	
	100	30×25	0.20	0.64	EKMM451VSN101MR25S						

◆RATED RIPPLE CURRENT MULTIPLIERS

●Frequency Multipliers

Frequency (Hz)	50	120	300	1k	10k	50k
160 to 250V _{dc}	0.81	1.00	1.17	1.32	1.45	1.50
315 to 450V _{dc}	0.77	1.00	1.16	1.30	1.41	1.43

The endurance of capacitors is reduced with internal heating produced by ripple current at the rate of halving the lifetime with every 5°C rise. When long life performance is required in actual use, the rms ripple current has to be reduced.

SMH Series

- Endurance with ripple current : 2,000 hours at 85°C
- Non solvent resistant type
- RoHS Compliant

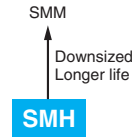

◆ SPECIFICATIONS

Items	Characteristics										
Category	-40 to +85°C										
Temperature Range	-40 to +85°C										
Rated Voltage Range	6.3 to 100V _{dc}										
Capacitance Tolerance	±20% (M) (at 20°C, 120Hz)										
Leakage Current	I=0.02CV or 3mA, whichever is smaller. Where, I : Max. leakage current (µA), C : Nominal capacitance (µF), V : Rated voltage (V) (at 20°C after 5 minutes)										
Dissipation Factor (tanδ)	Rated voltage (V _{dc})	6.3V	10V	16V	25V	35V	50V	63V	80V	100V	(at 20°C, 120Hz)
	tanδ (Max.)	0.60	0.50	0.40	0.30	0.25	0.20	0.15	0.15	0.15	
Low Temperature Characteristics (Max. Impedance Ratio)	Rated voltage (V _{dc})	6.3V	10V	16V	25V	35V	50V	63V	80V	100V	(at 120Hz)
	Z(-25°C)/Z(+20°C)	4	4	4	3	3	2	2	2	2	
	Z(-40°C)/Z(+20°C)	15	15	15	10	8	6	6	5	5	
Endurance	The following specifications shall be satisfied when the capacitors are restored to 20°C after subjected to DC voltage with the rated ripple current is applied (the peak voltage shall not exceed the rated voltage) for 2,000 hours at 85°C.										
	Capacitance change	≤±20% of the initial value									
	D.F. (tanδ)	≤200% of the initial specified value									
	Leakage current	≤The initial specified value									
Shelf Life	The following specifications shall be satisfied when the capacitors are restored to 20°C after exposing them for 1,000 hours at 85°C without voltage applied. Before the measurement, the capacitor shall be preconditioned by applying voltage according to Item 4.1 of JIS C 5101-4.										
	Capacitance change	≤±20% of the initial value									
	D.F. (tanδ)	≤150% of the initial specified value									
	Leakage current	≤The initial specified value									

◆ DIMENSIONS [mm]

● Terminal Code : VS (φ22 to φ35) : Standard

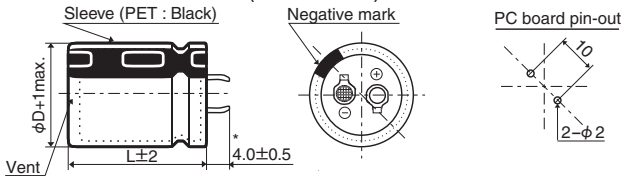

*φD=35mm : 3.5±0.5mm

The standard design has no plastic disc.

● Terminal Code : LI (φ35)

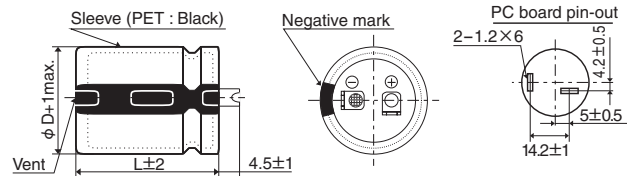

◆ PART NUMBERING SYSTEM

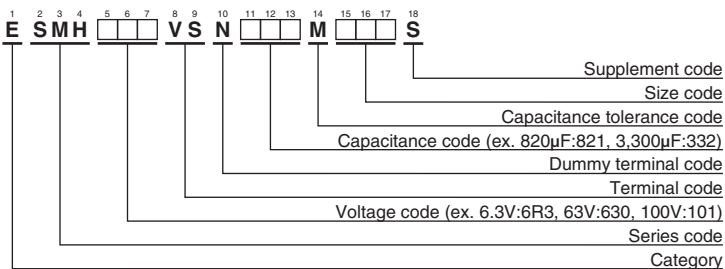

Please refer to "Product code guide (snap-in type)"

◆STANDARD RATINGS

WV (Vdc)	Cap (μF)	Case size φD×L(mm)	tanδ	Rated ripple current (Arms/85°C, 120Hz)	Part No.	WV (Vdc)	Cap (μF)	Case size φD×L(mm)	tanδ	Rated ripple current (Arms/85°C, 120Hz)	Part No.
6.3	15,000	22×25	0.60	2.44	ESMH6R3VSN153MP25S	16	27,000	25.4×45	0.40	4.72	ESMH160VSN273MQ45S
	18,000	22×30	0.60	2.67	ESMH6R3VSN183MP30S		27,000	30×35	0.40	4.82	ESMH160VSN273MR35S
	18,000	25.4×25	0.60	2.70	ESMH6R3VSN183MQ25S		27,000	35×30	0.40	4.65	ESMH160VSN273MA30S
	22,000	22×30	0.60	3.06	ESMH6R3VSN223MP30S		33,000	25.4×50	0.40	5.33	ESMH160VSN333MQ50S
	22,000	25.4×25	0.60	3.07	ESMH6R3VSN223MQ25S		33,000	30×40	0.40	5.36	ESMH160VSN333MR40S
	27,000	22×35	0.60	3.49	ESMH6R3VSN273MP35S		33,000	35×30	0.40	5.15	ESMH160VSN333MA30S
	27,000	25.4×30	0.60	3.52	ESMH6R3VSN273MQ30S		39,000	30×45	0.40	6.01	ESMH160VSN393MR45S
	27,000	30×25	0.60	3.57	ESMH6R3VSN273MR25S		39,000	35×35	0.40	5.95	ESMH160VSN393MA35S
	33,000	22×40	0.60	3.97	ESMH6R3VSN333MP40S		47,000	30×50	0.40	6.79	ESMH160VSN473MR50S
	33,000	25.4×35	0.60	4.02	ESMH6R3VSN333MQ35S		47,000	35×40	0.40	6.76	ESMH160VSN473MA40S
	33,000	30×25	0.60	3.95	ESMH6R3VSN333MR25S		56,000	35×45	0.40	7.62	ESMH160VSN563MA45S
	39,000	22×50	0.60	4.55	ESMH6R3VSN393MP50S		68,000	35×50	0.40	8.63	ESMH160VSN683MA50S
	39,000	25.4×40	0.60	4.50	ESMH6R3VSN393MQ40S		5,600	22×25	0.30	2.21	ESMH250VSN562MP25S
	39,000	30×30	0.60	4.45	ESMH6R3VSN393MR30S		6,800	22×30	0.30	2.40	ESMH250VSN682MP30S
	39,000	35×25	0.60	4.51	ESMH6R3VSN393MA25S		6,800	25.4×25	0.30	2.56	ESMH250VSN682MQ25S
	47,000	25.4×45	0.60	5.09	ESMH6R3VSN473MQ45S		8,200	22×35	0.30	2.72	ESMH250VSN822MP35S
	47,000	30×35	0.60	5.06	ESMH6R3VSN473MR35S		8,200	25.4×25	0.30	2.80	ESMH250VSN822MQ25S
	47,000	35×30	0.60	5.01	ESMH6R3VSN473MA30S		10,000	22×40	0.30	3.09	ESMH250VSN103MP40S
	56,000	25.4×50	0.60	5.71	ESMH6R3VSN563MQ50S		10,000	25.4×30	0.30	3.12	ESMH250VSN103MQ30S
	56,000	30×40	0.60	5.70	ESMH6R3VSN563MR40S		10,000	30×25	0.30	3.21	ESMH250VSN103MR25S
56,000	35×30	0.60	5.77	ESMH6R3VSN563MA30S	12,000	22×45	0.30	3.43	ESMH250VSN123MP45S		
68,000	30×45	0.60	6.48	ESMH6R3VSN683MR45S	12,000	25.4×35	0.30	3.43	ESMH250VSN123MQ35S		
68,000	35×35	0.60	6.42	ESMH6R3VSN683MA35S	12,000	30×30	0.30	3.86	ESMH250VSN123MR30S		
82,000	30×50	0.60	7.32	ESMH6R3VSN823MR50S	12,000	35×25	0.30	3.54	ESMH250VSN123MA25S		
82,000	35×40	0.60	7.29	ESMH6R3VSN823MA40S	15,000	22×50	0.30	4.00	ESMH250VSN153MP50S		
100,000	35×45	0.60	8.31	ESMH6R3VSN104MA45S	15,000	25.4×40	0.30	3.95	ESMH250VSN153MQ40S		
10	12,000	22×25	0.50	2.39	ESMH100VSN123MP25S	15,000	30×30	0.30	4.00	ESMH250VSN153MR30S	
	15,000	22×30	0.50	2.76	ESMH100VSN153MP30S	15,000	35×25	0.30	3.95	ESMH250VSN153MA25S	
	15,000	25.4×25	0.50	2.77	ESMH100VSN153MQ25S	18,000	25.4×45	0.30	4.45	ESMH250VSN183MQ45S	
	18,000	22×35	0.50	3.12	ESMH100VSN183MP35S	18,000	30×35	0.30	4.46	ESMH250VSN183MR35S	
	18,000	25.4×25	0.50	3.04	ESMH100VSN183MQ25S	18,000	35×30	0.30	4.63	ESMH250VSN183MA30S	
	22,000	22×40	0.50	3.55	ESMH100VSN223MP40S	22,000	25.4×50	0.30	5.02	ESMH250VSN223MQ50S	
	22,000	25.4×30	0.50	3.48	ESMH100VSN223MQ30S	22,000	30×45	0.30	5.21	ESMH250VSN223MR45S	
	22,000	30×25	0.50	3.53	ESMH100VSN223MR25S	22,000	35×35	0.30	5.16	ESMH250VSN223MA35S	
	27,000	22×45	0.50	4.04	ESMH100VSN273MP45S	27,000	30×50	0.30	5.94	ESMH250VSN273MR50S	
	27,000	25.4×35	0.50	3.98	ESMH100VSN273MQ35S	27,000	35×40	0.30	5.92	ESMH250VSN273MA40S	
	27,000	30×30	0.50	3.73	ESMH100VSN273MR30S	33,000	35×45	0.30	6.75	ESMH250VSN333MA45S	
	27,000	35×25	0.50	3.73	ESMH100VSN273MA25S	39,000	35×50	0.30	7.56	ESMH250VSN393MA50S	
	33,000	22×50	0.50	4.58	ESMH100VSN333MP50S	3,900	22×25	0.25	2.22	ESMH350VSN392MP25S	
	33,000	25.4×40	0.50	4.54	ESMH100VSN333MQ40S	4,700	22×30	0.25	2.41	ESMH350VSN472MP30S	
	33,000	30×30	0.50	4.13	ESMH100VSN333MR30S	4,700	25.4×25	0.25	2.42	ESMH350VSN472MQ25S	
	33,000	35×25	0.50	4.13	ESMH100VSN333MA25S	5,600	22×35	0.25	2.75	ESMH350VSN562MP35S	
	39,000	25.4×45	0.50	5.08	ESMH100VSN393MQ45S	5,600	25.4×25	0.25	2.64	ESMH350VSN562MQ25S	
	39,000	30×35	0.50	5.05	ESMH100VSN393MR35S	6,800	22×40	0.25	2.80	ESMH350VSN682MP40S	
	39,000	35×30	0.50	4.80	ESMH100VSN393MA30S	6,800	25.4×30	0.25	2.74	ESMH350VSN682MR30S	
	47,000	25.4×50	0.50	5.73	ESMH100VSN473MQ50S	6,800	30×25	0.25	2.97	ESMH350VSN682MR25S	
47,000	30×40	0.50	5.72	ESMH100VSN473MR40S	8,200	22×45	0.25	3.47	ESMH350VSN822MP45S		
47,000	35×30	0.50	5.27	ESMH100VSN473MA30S	8,200	25.4×35	0.25	3.10	ESMH350VSN822MQ35S		
56,000	30×45	0.50	6.44	ESMH100VSN563MR45S	8,200	30×30	0.25	3.13	ESMH350VSN822MR30S		
56,000	35×35	0.50	6.38	ESMH100VSN563MA35S	8,200	35×25	0.25	2.73	ESMH350VSN822MA25S		
68,000	30×50	0.50	7.27	ESMH100VSN683MR50S	10,000	22×50	0.25	3.57	ESMH350VSN103MP50S		
68,000	35×40	0.50	7.27	ESMH100VSN683MA40S	10,000	25.4×40	0.25	3.53	ESMH350VSN103MQ40S		
82,000	35×50	0.50	8.49	ESMH100VSN823MA50S	10,000	30×30	0.25	3.46	ESMH350VSN103MR30S		
16	8,200	22×25	0.40	2.51	ESMH160VSN822MP25S	10,000	35×25	0.25	3.02	ESMH350VSN103MA25S	
	10,000	22×25	0.40	2.77	ESMH160VSN103MP25S	12,000	25.4×45	0.25	3.98	ESMH350VSN123MQ45S	
	12,000	22×30	0.40	2.86	ESMH160VSN123MP30S	12,000	30×35	0.25	4.01	ESMH350VSN123MR35S	
	12,000	25.4×25	0.40	2.95	ESMH160VSN123MQ25S	12,000	35×30	0.25	4.42	ESMH350VSN123MA30S	
	15,000	22×35	0.40	3.29	ESMH160VSN153MP35S	15,000	25.4×50	0.25	4.54	ESMH350VSN153MQ50S	
	15,000	25.4×30	0.40	3.46	ESMH160VSN153MQ30S	15,000	30×40	0.25	4.52	ESMH350VSN153MR40S	
	15,000	30×25	0.40	3.66	ESMH160VSN153MR25S	15,000	35×35	0.25	5.01	ESMH350VSN153MA35S	
	18,000	22×40	0.40	3.72	ESMH160VSN183MP40S	18,000	30×45	0.25	4.71	ESMH350VSN183MR45S	
	18,000	25.4×35	0.40	3.98	ESMH160VSN183MQ35S	18,000	35×40	0.25	5.54	ESMH350VSN183MA40S	
	18,000	30×25	0.40	4.00	ESMH160VSN183MR25S	22,000	30×50	0.25	5.33	ESMH350VSN223MR50S	
	22,000	22×50	0.40	4.37	ESMH160VSN223MP50S	22,000	35×45	0.25	6.04	ESMH350VSN223MA45S	
	22,000	25.4×40	0.40	4.26	ESMH160VSN223MQ40S	27,000	35×50	0.25	6.89	ESMH350VSN273MA50S	
	22,000	30×30	0.40	4.21	ESMH160VSN223MR30S	2,200	22×25	0.20	1.91	ESMH500VSN222MP25S	
	22,000	35×25	0.40	4.15	ESMH160VSN223MA25S	3,300	22×30	0.20	2.37	ESMH500VSN332MP30S	

◆ STANDARD RATINGS

WV (Vdc)	Cap (μF)	Case size φD×L(mm)	tanδ	Rated ripple current (Arms/85°C, 120Hz)	Part No.	WV (Vdc)	Cap (μF)	Case size φD×L(mm)	tanδ	Rated ripple current (Arms/85°C, 120Hz)	Part No.
50	3,300	25.4×25	0.20	2.38	ESMH500VSN332MQ25S	80	1,200	22×25	0.15	1.69	ESMH800VSN122MP25S
	3,900	22×35	0.20	2.65	ESMH500VSN392MP35S		1,500	22×25	0.15	1.88	ESMH800VSN152MP25S
	3,900	25.4×30	0.20	2.68	ESMH500VSN392MQ30S		1,800	22×30	0.15	2.14	ESMH800VSN182MP30S
	3,900	30×25	0.20	2.55	ESMH500VSN392MR25S		1,800	25.4×25	0.15	2.26	ESMH800VSN182MQ25S
	4,700	22×40	0.20	2.99	ESMH500VSN472MP40S		2,200	22×35	0.15	2.44	ESMH800VSN222MP35S
	4,700	25.4×35	0.20	3.03	ESMH500VSN472MQ35S		2,200	25.4×30	0.15	2.46	ESMH800VSN222MQ30S
	4,700	30×25	0.20	2.81	ESMH500VSN472MR25S		2,200	30×25	0.15	2.49	ESMH800VSN222MR25S
	5,600	22×45	0.20	3.36	ESMH500VSN562MP45S		2,700	22×40	0.15	2.78	ESMH800VSN272MP40S
	5,600	25.4×35	0.20	3.31	ESMH500VSN562MQ35S		2,700	25.4×35	0.15	2.81	ESMH800VSN272MQ35S
	5,600	30×30	0.20	3.37	ESMH500VSN562MR30S		2,700	30×25	0.15	2.75	ESMH800VSN272MR25S
	5,600	35×25	0.20	3.42	ESMH500VSN562MA25S		3,300	22×45	0.15	3.16	ESMH800VSN332MP45S
	6,800	22×50	0.20	3.81	ESMH500VSN682MP50S		3,300	25.4×40	0.15	3.21	ESMH800VSN332MQ40S
	6,800	25.4×40	0.20	3.81	ESMH500VSN682MQ40S		3,300	30×30	0.15	3.17	ESMH800VSN332MR30S
	6,800	30×35	0.20	3.85	ESMH500VSN682MR35S		3,300	35×25	0.15	3.21	ESMH800VSN332MA25S
	6,800	35×30	0.20	3.85	ESMH500VSN682MA30S		3,900	22×50	0.15	3.52	ESMH800VSN392MP50S
	8,200	25.4×50	0.20	4.37	ESMH500VSN822MQ50S		3,900	25.4×45	0.15	3.59	ESMH800VSN392MQ45S
	8,200	30×40	0.20	4.36	ESMH500VSN822MR40S		3,900	30×35	0.15	3.57	ESMH800VSN392MR35S
	8,200	35×30	0.20	4.41	ESMH500VSN822MA30S		3,900	35×25	0.15	3.50	ESMH800VSN392MA25S
10,000	30×45	0.20	4.97	ESMH500VSN103MR45S	4,700	25.4×50	0.15	4.05	ESMH800VSN472MQ50S		
10,000	35×35	0.20	4.92	ESMH500VSN103MA35S	4,700	30×40	0.15	4.05	ESMH800VSN472MR40S		
12,000	30×50	0.20	5.60	ESMH500VSN123MR50S	4,700	35×30	0.15	4.09	ESMH800VSN472MA30S		
12,000	35×40	0.20	5.58	ESMH500VSN123MA40S	5,600	30×45	0.15	4.55	ESMH800VSN562MA45S		
15,000	35×45	0.20	6.44	ESMH500VSN153MA45S	5,600	35×35	0.15	4.51	ESMH800VSN562MA35S		
18,000	35×50	0.20	6.71	ESMH500VSN183MA50S	6,800	30×50	0.15	5.16	ESMH800VSN682MR50S		
63	1,800	22×25	0.15	1.82	ESMH630VSN182MP25S	6,800	35×40	0.15	5.14	ESMH800VSN682MA40S	
	2,200	22×30	0.15	2.31	ESMH630VSN222MP30S	8,200	35×45	0.15	5.83	ESMH800VSN822MA45S	
	2,200	25.4×25	0.15	2.30	ESMH630VSN222MQ25S	10,000	35×50	0.15	6.63	ESMH800VSN103MA50S	
	2,700	22×35	0.15	2.40	ESMH630VSN272MP35S	820	22×25	0.15	1.86	ESMH101VSN821MP25S	
	2,700	25.4×25	0.15	2.40	ESMH630VSN272MQ25S	1,200	22×30	0.15	2.09	ESMH101VSN122MP30S	
	3,300	22×35	0.15	2.62	ESMH630VSN332MP35S	1,200	25.4×25	0.15	2.10	ESMH101VSN122MQ25S	
	3,300	25.4×30	0.15	2.64	ESMH630VSN332MQ30S	1,500	22×35	0.15	2.41	ESMH101VSN152MP35S	
	3,300	30×25	0.15	2.78	ESMH630VSN332MR25S	1,500	25.4×30	0.15	2.43	ESMH101VSN152MQ30S	
	3,900	22×40	0.15	2.93	ESMH630VSN392MP40S	1,500	30×25	0.15	2.46	ESMH101VSN152MR25S	
	3,900	25.4×35	0.15	2.97	ESMH630VSN392MQ35S	1,800	22×40	0.15	2.71	ESMH101VSN182MP40S	
	3,900	30×30	0.15	3.00	ESMH630VSN392MR30S	1,800	25.4×35	0.15	2.75	ESMH101VSN182MQ35S	
	3,900	35×25	0.15	3.00	ESMH630VSN392MA25S	1,800	30×25	0.15	2.72	ESMH101VSN182MR25S	
	4,700	22×50	0.15	3.39	ESMH630VSN472MP50S	2,200	22×45	0.15	3.08	ESMH101VSN222MP45S	
	4,700	25.4×40	0.15	3.36	ESMH630VSN472MQ40S	2,200	25.4×40	0.15	3.13	ESMH101VSN222MQ40S	
	4,700	30×30	0.15	3.32	ESMH630VSN472MR30S	2,200	30×30	0.15	3.09	ESMH101VSN222MR30S	
	4,700	35×25	0.15	3.36	ESMH630VSN472MA25S	2,200	35×25	0.15	3.14	ESMH101VSN222MA25S	
	5,600	25.4×45	0.15	3.77	ESMH630VSN562MQ45S	2,700	22×50	0.15	3.53	ESMH101VSN272MP50S	
	5,600	30×35	0.15	3.75	ESMH630VSN562MR35S	2,700	25.4×45	0.15	3.57	ESMH101VSN272MQ45S	
	5,600	35×30	0.15	3.76	ESMH630VSN562MA30S	2,700	30×35	0.15	3.55	ESMH101VSN272MR35S	
	6,800	25.4×50	0.15	4.27	ESMH630VSN682MQ50S	2,700	35×30	0.15	3.71	ESMH101VSN272MA30S	
	6,800	30×40	0.15	4.27	ESMH630VSN682MR40S	3,300	25.4×50	0.15	4.06	ESMH101VSN332MQ50S	
	6,800	35×30	0.15	4.15	ESMH630VSN682MA30S	3,300	30×40	0.15	4.05	ESMH101VSN332MR40S	
	8,200	30×45	0.15	4.83	ESMH630VSN822MR45S	3,300	35×30	0.15	4.05	ESMH101VSN332MA30S	
	8,200	35×35	0.15	4.79	ESMH630VSN822MA35S	3,900	30×45	0.15	4.54	ESMH101VSN392MR45S	
10,000	30×50	0.15	5.49	ESMH630VSN103MR50S	3,900	35×35	0.15	4.49	ESMH101VSN392MA35S		
10,000	35×40	0.15	5.47	ESMH630VSN103MA40S	4,700	30×50	0.15	5.13	ESMH101VSN472MR50S		
12,000	35×45	0.15	6.19	ESMH630VSN123MA45S	4,700	35×40	0.15	5.11	ESMH101VSN472MA40S		
63	1,200	22×25	0.15	1.86	ESMH101VSN821MP25S	5,600	35×45	0.15	5.75	ESMH101VSN562MA45S	
	1,200	22×30	0.15	2.09	ESMH101VSN122MP30S	6,800	35×50	0.15	6.50	ESMH101VSN682MA50S	
	1,200	25.4×25	0.15	2.10	ESMH101VSN122MQ25S						
	1,500	22×35	0.15	2.41	ESMH101VSN152MP35S						
	1,500	25.4×30	0.15	2.43	ESMH101VSN152MQ30S						
	1,500	30×25	0.15	2.46	ESMH101VSN152MR25S						
	1,800	22×40	0.15	2.71	ESMH101VSN182MP40S						
	1,800	25.4×35	0.15	2.75	ESMH101VSN182MQ35S						
	1,800	30×25	0.15	2.72	ESMH101VSN182MR25S						
	2,200	22×45	0.15	3.08	ESMH101VSN222MP45S						
	2,200	25.4×40	0.15	3.13	ESMH101VSN222MQ40S						
	2,200	30×30	0.15	3.09	ESMH101VSN222MR30S						

*For the rated voltage $\geq 160V_{dc}$, please use SMQ series

◆ RATED RIPPLE CURRENT MULTIPLIERS

● Frequency Multipliers

Frequency (Hz)	50	120	300	1k	10k	50k
6.3 to 50V _{dc}	0.95	1.00	1.03	1.05	1.08	1.08
63 to 100V _{dc}	0.92	1.00	1.07	1.13	1.19	1.20

The endurance of capacitors is reduced with internal heating produced by ripple current at the rate of halving the lifetime with every 5°C rise. When long life performance is required in actual use, the rms ripple current has to be reduced.

KMH Series

- Endurance with ripple current : 2,000 hours at 105°C
- Non solvent resistant type
- RoHS Compliant

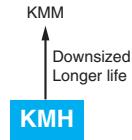

◆SPECIFICATIONS

Items	Characteristics										
Category	-40 to +105°C										
Temperature Range	-40 to +105°C										
Rated Voltage Range	6.3 to 100V _{dc}										
Capacitance Tolerance	±20% (M) (at 20°C, 120Hz)										
Leakage Current	I=0.02CV or 3mA, whichever is smaller Where, I : Max. leakage current (µA), C : Nominal capacitance (µF), V : Rated voltage (V) (at 20°C after 5 minutes)										
Dissipation Factor (tanδ)	Rated voltage (V _{dc})	6.3V	10V	16V	25V	35V	50V	63V	80V	100V	(at 20°C, 120Hz)
	tan δ (Max.)	0.60	0.50	0.40	0.30	0.25	0.20	0.15	0.15	0.15	
Low Temperature Characteristics (Max. Impedance Ratio)	Rated voltage (V _{dc})	6.3V	10V	16V	25V	35V	50V	63V	80V	100V	(at 120Hz)
	Z(-25°C)/Z(+20°C)	4	4	4	3	3	2	2	2	2	
	Z(-45°C)/Z(+20°C)	15	15	15	10	8	6	6	5	5	
Endurance	The following specifications shall be satisfied when the capacitors are restored to 20°C after subjected to DC voltage with the rated ripple current is applied (the peak voltage shall not exceed the rated voltage) for 2,000 hours at 105°C										
	Capacitance change	≤±20% of the initial value									
	D.F. (tanδ)	≤200% of the initial specified value									
	Leakage current	≤The initial specified value									
Shelf Life	The following specifications shall be satisfied when the capacitors are restored to 20°C after exposing them for 1,000 hours at 105°C without voltage applied. Before the measurement, the capacitor shall be preconditioned by applying voltage according to Item 4.1 of JIS C 5101-4.										
	Capacitance change	≤±20% of the initial value									
	D.F. (tanδ)	≤150% of the initial specified value									
	Leakage current	≤The initial specified value									

◆DIMENSIONS [mm]

- Terminal Code : VS (φ22 to φ35) : Standard

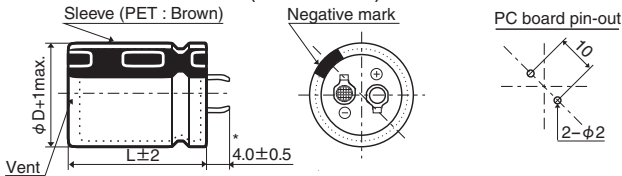

*φD=35mm : 3.5±0.5mm

The standard design has no plastic disc.

- Terminal Code : LI (φ35)

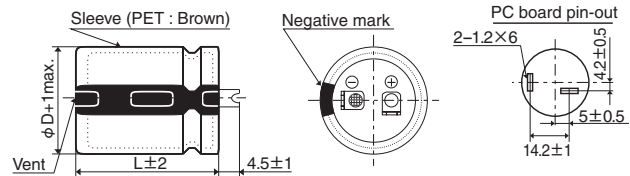

◆PART NUMBERING SYSTEM

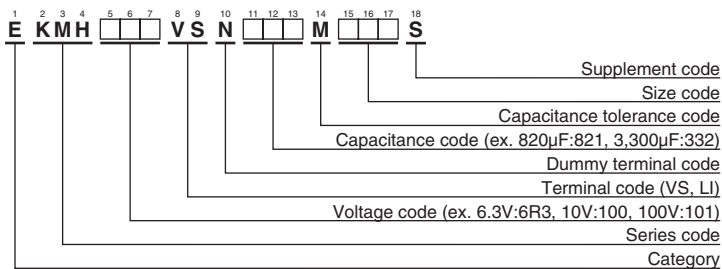

Please refer to "Product code guide (snap-in type)"

◆STANDARD RATINGS

WV (Vdc)	Cap (μF)	Case size φD×L(mm)	tanδ	Rated ripple current (Arms/105°C,120Hz)	Part No.	WV (Vdc)	Cap (μF)	Case size φD×L(mm)	tanδ	Rated ripple current (Arms/105°C,120Hz)	Part No.		
6.3	12,000	22×25	0.60	1.54	EKMH6R3VSN123MP25S	16	27,000	35×30	0.40	3.45	EKMH160VSN273MA30S		
	15,000	22×25	0.60	1.72	EKMH6R3VSN153MP25S		33,000	30×45	0.40	4.30	EKMH160VSN333MR45S		
	18,000	22×30	0.60	1.95	EKMH6R3VSN183MP30S		33,000	35×35	0.40	4.26	EKMH160VSN333MA35S		
	18,000	25.4×25	0.60	1.96	EKMH6R3VSN183MQ25S		39,000	30×50	0.40	4.81	EKMH160VSN393MR50S		
	22,000	22×35	0.60	2.23	EKMH6R3VSN223MP35S		39,000	35×40	0.40	4.79	EKMH160VSN393MA40S		
	22,000	25.4×30	0.60	2.25	EKMH6R3VSN223MQ30S		47,000	35×45	0.40	5.43	EKMH160VSN473MA45S		
	22,000	30×25	0.60	2.28	EKMH6R3VSN223MR25S		25	4,700	22×25	0.30	1.50	EKMH250VSN472MP25S	
	27,000	22×40	0.60	2.54	EKMH6R3VSN273MP40S			5,600	22×25	0.30	1.63	EKMH250VSN562MP25S	
	27,000	25.4×35	0.60	2.57	EKMH6R3VSN273MQ35S			6,800	22×30	0.30	1.86	EKMH250VSN682MP30S	
	27,000	30×25	0.60	2.52	EKMH6R3VSN273MR25S			6,800	25.4×25	0.30	1.87	EKMH250VSN682MQ25S	
	33,000	22×45	0.60	2.88	EKMH6R3VSN333MP45S			8,200	22×35	0.30	2.11	EKMH250VSN822MP35S	
	33,000	25.4×40	0.60	2.93	EKMH6R3VSN333MQ40S			8,200	25.4×30	0.30	2.12	EKMH250VSN822MQ30S	
	33,000	30×30	0.60	2.89	EKMH6R3VSN333MR30S			8,200	30×25	0.30	2.15	EKMH250VSN822MR25S	
	33,000	35×25	0.60	2.93	EKMH6R3VSN333MA25S			10,000	22×40	0.30	2.39	EKMH250VSN103MP40S	
	39,000	25.4×40	0.60	3.18	EKMH6R3VSN393MQ40S			10,000	25.4×35	0.30	2.42	EKMH250VSN103MQ35S	
	39,000	30×35	0.60	3.26	EKMH6R3VSN393MR35S			10,000	30×25	0.30	2.37	EKMH250VSN103MR25S	
	39,000	35×30	0.60	3.40	EKMH6R3VSN393MA30S	12,000		22×45	0.30	2.69	EKMH250VSN123MP45S		
	47,000	25.4×50	0.60	3.69	EKMH6R3VSN473MQ50S	12,000		25.4×40	0.30	2.74	EKMH250VSN123MQ40S		
	47,000	30×40	0.60	3.69	EKMH6R3VSN473MR40S	12,000		30×30	0.30	2.70	EKMH250VSN123MR30S		
	47,000	35×30	0.60	3.73	EKMH6R3VSN473MA30S	12,000		35×25	0.30	2.74	EKMH250VSN123MA25S		
	56,000	30×45	0.60	4.16	EKMH6R3VSN563MR45S	15,000		25.4×45	0.30	3.15	EKMH250VSN153MQ45S		
	56,000	35×35	0.60	4.12	EKMH6R3VSN563MA35S	15,000		30×35	0.30	3.13	EKMH250VSN153MR35S		
	68,000	30×50	0.60	4.71	EKMH6R3VSN683MR50S	15,000	35×30	0.30	3.27	EKMH250VSN153MA30S			
	68,000	35×40	0.60	4.69	EKMH6R3VSN683MA40S	18,000	25.4×50	0.30	3.54	EKMH250VSN183MQ50S			
	82,000	35×45	0.60	5.32	EKMH6R3VSN823MA45S	18,000	30×40	0.30	3.54	EKMH250VSN183MR40S			
	10	10,000	22×25	0.50	1.55	EKMH100VSN103MP25S	18,000	35×30	0.30	3.58	EKMH250VSN183MA30S		
		12,000	22×30	0.50	1.77	EKMH100VSN123MP30S	22,000	30×45	0.30	4.04	EKMH250VSN223MR45S		
		15,000	22×30	0.50	1.97	EKMH100VSN153MP30S	22,000	35×35	0.30	3.64	EKMH250VSN223MA35S		
		15,000	25.4×25	0.50	1.96	EKMH100VSN153MQ25S	27,000	35×45	0.30	4.73	EKMH250VSN273MA45S		
		18,000	22×35	0.50	2.21	EKMH100VSN183MP35S	33,000	35×50	0.30	5.89	EKMH250VSN333MA50S		
		18,000	25.4×30	0.50	2.23	EKMH100VSN183MQ30S	35	3,300	22×25	0.25	1.40	EKMH350VSN332MP25S	
		22,000	22×40	0.50	2.51	EKMH100VSN223MP40S		3,900	22×30	0.25	1.57	EKMH350VSN392MP30S	
22,000		25.4×35	0.50	2.54	EKMH100VSN223MQ35S	4,700		22×30	0.25	1.72	EKMH350VSN472MP30S		
22,000		30×25	0.50	2.40	EKMH100VSN223MR25S	4,700		25.4×25	0.25	1.80	EKMH350VSN472MQ25S		
27,000		22×50	0.50	2.93	EKMH100VSN273MP50S	5,600		22×35	0.25	1.95	EKMH350VSN562MP35S		
27,000		25.4×40	0.50	2.90	EKMH100VSN273MQ40S	5,600		25.4×30	0.25	1.96	EKMH350VSN562MQ30S		
27,000		30×30	0.50	2.87	EKMH100VSN273MR30S	5,600		30×25	0.25	1.99	EKMH350VSN562MR25S		
27,000		35×25	0.50	2.73	EKMH100VSN273MA25S	6,800		22×40	0.25	2.20	EKMH350VSN682MP40S		
33,000		25.4×45	0.50	3.30	EKMH100VSN333MQ45S	6,800		25.4×35	0.25	2.23	EKMH350VSN682MQ35S		
33,000		30×35	0.50	3.28	EKMH100VSN333MR35S	6,800		30×25	0.25	2.19	EKMH350VSN682MR25S		
33,000		35×30	0.50	3.16	EKMH100VSN333MA30S	8,200		22×50	0.25	2.55	EKMH350VSN822MP50S		
39,000		25.4×50	0.50	3.68	EKMH100VSN393MQ50S	8,200		25.4×40	0.25	2.53	EKMH350VSN822MQ40S		
39,000		30×40	0.50	3.69	EKMH100VSN393MR40S	8,200		30×30	0.25	2.75	EKMH350VSN822MR30S		
39,000		35×30	0.50	3.43	EKMH100VSN393MA30S	8,200		35×25	0.25	2.75	EKMH350VSN822MA25S		
47,000		30×45	0.50	4.17	EKMH100VSN473MR45S	10,000		25.4×45	0.25	2.87	EKMH350VSN103MQ45S		
47,000		35×35	0.50	3.76	EKMH100VSN473MA35S	10,000		30×35	0.25	2.90	EKMH350VSN103MR35S		
56,000		30×50	0.50	4.68	EKMH100VSN563MR50S	10,000		35×30	0.25	2.91	EKMH350VSN103MA30S		
56,000		35×40	0.50	4.67	EKMH100VSN563MA40S	12,000		25.4×50	0.25	3.24	EKMH350VSN123MQ50S		
68,000		35×50	0.50	5.46	EKMH100VSN683MA50S	12,000		30×40	0.25	3.23	EKMH350VSN123MR40S		
16		6,800	22×25	0.40	1.57	EKMH160VSN682MP25S		12,000	35×30	0.25	2.99	EKMH350VSN123MA30S	
		10,000	22×30	0.40	1.97	EKMH160VSN103MP30S		15,000	30×45	0.25	3.72	EKMH350VSN153MR45S	
		10,000	25.4×25	0.40	1.97	EKMH160VSN103MQ25S		15,000	35×35	0.25	3.67	EKMH350VSN153MA35S	
		12,000	22×35	0.40	2.22	EKMH160VSN123MP35S		18,000	35×40	0.25	4.37	EKMH350VSN183MA40S	
		12,000	25.4×30	0.40	2.24	EKMH160VSN123MQ30S		22,000	35×50	0.25	4.92	EKMH350VSN223MA50S	
		12,000	30×25	0.40	2.45	EKMH160VSN123MR25S		50	1,800	22×25	0.20	1.33	EKMH500VSN182MP25S
		15,000	22×40	0.40	2.55	EKMH160VSN153MP40S			2,700	22×30	0.20	1.69	EKMH500VSN272MP30S
		15,000	25.4×35	0.40	2.58	EKMH160VSN153MQ35S			2,700	25.4×25	0.20	1.70	EKMH500VSN272MQ25S
	15,000	30×25	0.40	2.52	EKMH160VSN153MR25S	3,300			22×35	0.20	1.93	EKMH500VSN332MP35S	
	18,000	22×45	0.40	2.87	EKMH160VSN183MP45S	3,300			25.4×30	0.20	1.85	EKMH500VSN332MQ30S	
	18,000	25.4×40	0.40	2.92	EKMH160VSN183MQ40S	3,900			22×40	0.20	2.16	EKMH500VSN392MP40S	
	18,000	30×30	0.40	2.88	EKMH160VSN183MR30S	3,900			25.4×35	0.20	2.18	EKMH500VSN392MQ35S	
	18,000	35×25	0.40	2.92	EKMH160VSN183MA25S	3,900			30×25	0.20	1.95	EKMH500VSN392MR25S	
	22,000	25.4×45	0.40	3.32	EKMH160VSN223MQ45S	4,700	22×45		0.20	2.43	EKMH500VSN472MP45S		
	22,000	30×35	0.40	3.29	EKMH160VSN223MR35S	4,700	25.4×35		0.20	2.39	EKMH500VSN472MQ35S		
	22,000	35×25	0.40	3.23	EKMH160VSN223MA25S	4,700	30×30		0.20	2.25	EKMH500VSN472MR30S		
	27,000	25.4×50	0.40	3.78	EKMH160VSN273MQ50S	4,700	35×25		0.20	2.48	EKMH500VSN472MA25S		
	27,000	30×40	0.40	3.77	EKMH160VSN273MR40S	5,600	22×50		0.20	2.75	EKMH500VSN562MP50S		

◆STANDARD RATINGS

WV (V _{dc})	Cap (μF)	Case size φD×L(mm)	tan δ	Rated ripple current (Arms/105°C, 120Hz)	Part No.	WV (V _{dc})	Cap (μF)	Case size φD×L(mm)	tan δ	Rated ripple current (Arms/105°C, 120Hz)	Part No.
50	5,600	25.4×40	0.20	2.70	EKMH500VSN562MQ40S	80	1,800	25.4×30	0.15	1.76	EKMH800VSN182MQ30S
	5,600	30×35	0.20	2.76	EKMH500VSN562MR35S		1,800	30×25	0.15	1.65	EKMH800VSN182MR25S
	5,600	35×25	0.20	2.70	EKMH500VSN562MA25S		2,200	22×45	0.15	2.04	EKMH800VSN222MP45S
	6,800	25.4×50	0.20	3.30	EKMH500VSN682MQ50S		2,200	25.4×35	0.15	2.01	EKMH800VSN222MQ35S
	6,800	30×40	0.20	3.30	EKMH500VSN682MR40S		2,200	30×30	0.15	2.05	EKMH800VSN222MR30S
	6,800	35×30	0.20	3.25	EKMH500VSN682MA30S		2,200	35×25	0.15	2.07	EKMH800VSN222MA25S
	8,200	30×45	0.20	3.60	EKMH500VSN822MR45S		2,700	25.4×45	0.15	2.36	EKMH800VSN272MQ45S
	8,200	35×35	0.20	3.55	EKMH500VSN822MA35S		2,700	30×35	0.15	2.35	EKMH800VSN272MR35S
	10,000	30×50	0.20	4.04	EKMH500VSN103MR50S		2,700	35×25	0.15	2.29	EKMH800VSN272MA25S
	10,000	35×40	0.20	4.03	EKMH500VSN103MA40S		3,300	25.4×50	0.15	2.68	EKMH800VSN332MQ50S
12,000	35×45	0.20	4.55	EKMH500VSN123MA45S	3,300	30×40	0.15	2.68	EKMH800VSN332MR40S		
63	1,200	22×25	0.15	1.19	EKMH630VSN122MP25S	3,300	35×30	0.15	2.45	EKMH800VSN332MA30S	
	1,500	22×25	0.15	1.33	EKMH630VSN152MP25S	3,900	30×45	0.15	3.00	EKMH800VSN392MR45S	
	1,800	22×30	0.15	1.51	EKMH630VSN182MP30S	3,900	35×35	0.15	2.98	EKMH800VSN392MA35S	
	1,800	25.4×25	0.15	1.52	EKMH630VSN182MQ25S	4,700	30×50	0.15	3.39	EKMH800VSN472MR50S	
	2,200	22×35	0.15	1.73	EKMH630VSN222MP35S	4,700	35×40	0.15	3.38	EKMH800VSN472MA40S	
	2,200	25.4×30	0.15	1.74	EKMH630VSN222MQ30S	5,600	35×45	0.15	3.80	EKMH800VSN562MA45S	
	2,700	22×40	0.15	1.97	EKMH630VSN272MP40S	6,800	35×50	0.15	3.90	EKMH800VSN682MA50S	
	2,700	25.4×35	0.15	1.99	EKMH630VSN272MQ35S	100	560	22×25	0.15	1.05	EKMH101VSN561MP25S
	2,700	30×25	0.15	1.76	EKMH630VSN272MR25S		820	22×30	0.15	1.32	EKMH101VSN821MP30S
	3,300	22×50	0.15	2.29	EKMH630VSN332MP50S		820	25.4×25	0.15	1.33	EKMH101VSN821MQ25S
	3,300	25.4×40	0.15	2.27	EKMH630VSN332MQ40S		1,000	22×35	0.15	1.50	EKMH101VSN102MP35S
	3,300	30×30	0.15	2.24	EKMH630VSN332MR30S		1,000	25.4×30	0.15	1.51	EKMH101VSN102MQ30S
	3,300	35×25	0.15	2.06	EKMH630VSN332MA25S		1,200	22×40	0.15	1.69	EKMH101VSN122MP40S
	3,900	25.4×45	0.15	2.54	EKMH630VSN392MQ45S		1,200	25.4×35	0.15	1.71	EKMH101VSN122MQ35S
	3,900	30×35	0.15	2.55	EKMH630VSN392MR35S		1,200	30×25	0.15	1.68	EKMH101VSN122MR25S
	3,900	35×25	0.15	2.24	EKMH630VSN392MA25S		1,500	22×45	0.15	1.94	EKMH101VSN152MP45S
	4,700	25.4×50	0.15	2.86	EKMH630VSN472MQ50S		1,500	25.4×40	0.15	1.98	EKMH101VSN152MQ40S
	4,700	30×40	0.15	2.86	EKMH630VSN472MR40S		1,500	30×30	0.15	1.95	EKMH101VSN152MR30S
	4,700	35×30	0.15	2.79	EKMH630VSN472MA30S		1,500	35×25	0.15	1.98	EKMH101VSN152MA25S
	5,600	30×45	0.15	3.22	EKMH630VSN562MR45S		1,800	25.4×45	0.15	2.23	EKMH101VSN182MQ45S
5,600	35×35	0.15	3.19	EKMH630VSN562MA35S	1,800		30×35	0.15	2.50	EKMH101VSN182MR35S	
6,800	30×50	0.15	3.65	EKMH630VSN682MR50S	1,800		35×25	0.15	2.17	EKMH101VSN182MA25S	
6,800	35×40	0.15	3.64	EKMH630VSN682MA40S	2,200		25.4×50	0.15	2.53	EKMH101VSN222MQ50S	
8,200	35×45	0.15	3.90	EKMH630VSN822MA45S	2,200		30×40	0.15	2.70	EKMH101VSN222MR40S	
10,000	35×50	0.15	4.40	EKMH630VSN103MA50S	2,200		35×30	0.15	2.50	EKMH101VSN222MA30S	
80	820	22×25	0.15	1.11	EKMH800VSN821MP25S		2,700	30×45	0.15	2.88	EKMH101VSN272MR45S
	1,000	22×25	0.15	1.22	EKMH800VSN102MP25S		2,700	35×35	0.15	2.86	EKMH101VSN272MA35S
	1,200	22×30	0.15	1.38	EKMH800VSN122MP30S	3,300	30×50	0.15	3.28	EKMH101VSN332MR50S	
	1,200	25.4×25	0.15	1.39	EKMH800VSN122MQ25S	3,300	35×40	0.15	3.27	EKMH101VSN332MA40S	
	1,500	22×35	0.15	1.59	EKMH800VSN152MP35S	3,900	35×45	0.15	3.67	EKMH101VSN392MA45S	
	1,500	25.4×30	0.15	1.61	EKMH800VSN152MQ30S	4,700	35×50	0.15	3.80	EKMH101VSN472MA50S	
	1,800	22×40	0.15	1.80	EKMH800VSN182MP40S						

*For the rated voltage $\geq 160V_{dc}$, please use KMR and KMQ series

◆RATED RIPPLE CURRENT MULTIPLIERS

●Frequency Multipliers

Frequency (Hz)	50	120	300	1k	10k	50k
6.3 to 50V _{dc}	0.95	1.00	1.03	1.05	1.08	1.08
63 to 100V _{dc}	0.92	1.00	1.07	1.13	1.19	1.20

The endurance of capacitors is reduced with internal heating produced by ripple current at the rate of halving the lifetime with every 5°C rise. When long life performance is required in actual use, the rms ripple current has to be reduced.

SLM Series

- 15mm height snap-ins
- Endurance with ripple current : 2,000 hours at 85°C
- Non solvent resistant type
- RoHS Compliant

SLM

Low profile

SMQ



◆SPECIFICATIONS

Items	Characteristics	
Category	-25 to +85°C	
Temperature Range	-25 to +85°C	
Rated Voltage Range	160 to 400V _{dc}	
Capacitance Tolerance	±20% (M) (at 20°C, 120Hz)	
Leakage Current	I ≤ 3√CV Where, I : Max. leakage current (µA), C : Nominal capacitance (µF), V : Rated voltage (V) (at 20°C after 5 minutes)	
Dissipation Factor (tan δ)	Rated voltage (V _{dc})	160 to 400V
	tan δ (Max.)	0.20 (at 20°C, 120Hz)
Low Temperature Characteristics (Max. Impedance Ratio)	Rated voltage (V _{dc})	160 to 400V
	Z (-25°C)/Z (+20°C)	4 (at 120Hz)
Endurance	The following specifications shall be satisfied when the capacitors are restored to 20°C after subjected to DC voltage with the rated ripple current is applied (the peak voltage shall not exceed the rated voltage) for 2,000 hours at 85°C.	
	Capacitance change	≤±20% of the initial value
	D.F. (tan δ)	≤200% of the initial specified value
	Leakage current	≤The initial specified value
Shelf Life	The following specifications shall be satisfied when the capacitors are restored to 20°C after exposing them for 1,000 hours at 85°C without voltage applied. Before the measurement, the capacitor shall be preconditioned by applying voltage according to Item 4.1 of JIS C 5101-4.	
	Capacitance change	≤±15% of the initial value
	D.F. (tan δ)	≤150% of the initial specified value
	Leakage current	≤The initial specified value

◆DIMENSIONS [mm]

- Terminal Code : VS

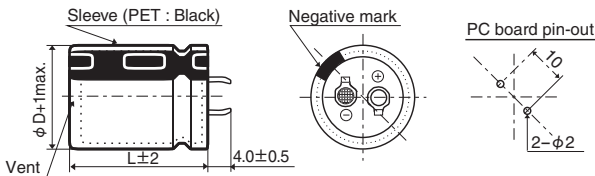

The standard design has no plastic disc.

◆PART NUMBERING SYSTEM

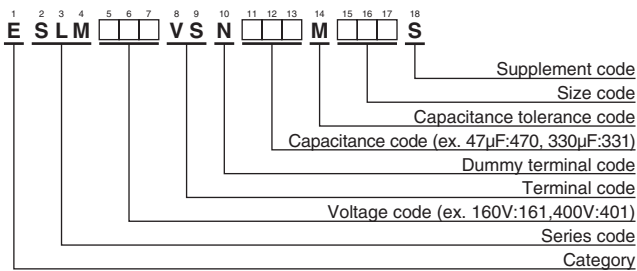

Please refer to "Product code guide (snap-in type)"

◆RATED RIPPLE CURRENT MULTIPLIERS

- Frequency Multipliers

Frequency (Hz)	50	120	300	1k	10k	50k
160 to 250V _{dc}	0.81	1.00	1.17	1.32	1.45	1.50
400V _{dc}	0.77	1.00	1.16	1.30	1.41	1.43

The endurance of capacitors is reduced with internal heating produced by ripple current at the rate of halving the lifetime with every 5°C rise.

When long life performance is required in actual use, the rms ripple current has to be reduced.

◆STANDARD RATINGS

WV (V _{dc})	Cap (µF)	Case size φD×L(mm)	tan δ	Rated ripple current (Arms/85°C, 120Hz)	Part No.	WV (V _{dc})	Cap (µF)	Case size φD×L(mm)	tan δ	Rated ripple current (Arms/85°C, 120Hz)	Part No.
160	180	22×15	0.20	0.99	ESLM161VSN181MP15S	200	270	30×15	0.20	1.22	ESLM201VSN271MR15S
	270	25.4×15	0.20	1.29	ESLM161VSN271MQ15S		390	35×15	0.20	1.46	ESLM201VSN391MA15S
	390	30×15	0.20	1.47	ESLM161VSN391MR15S	250	100	22×15	0.20	0.73	ESLM251VSN101MP15S
	560	35×15	0.20	1.74	ESLM161VSN561MA15S		150	25.4×15	0.20	0.96	ESLM251VSN151MQ15S
180	150	22×15	0.20	0.90	ESLM181VSN151MP15S		220	30×15	0.20	1.10	ESLM251VSN221MR15S
	220	25.4×15	0.20	1.16	ESLM181VSN221MQ15S	330	35×15	0.20	1.34	ESLM251VSN331MA15S	
	330	30×15	0.20	1.35	ESLM181VSN331MR15S	400	47	22×15	0.20	0.50	ESLM401VSN470MP15S
470	35×15	0.20	1.60	ESLM181VSN471MA15S	68		25.4×15	0.20	0.65	ESLM401VSN680MQ15S	
200	150	22×15	0.20	0.90	ESLM201VSN151MP15S		100	30×15	0.20	0.74	ESLM401VSN101MR15S
	220	25.4×15	0.20	1.16	ESLM201VSN221MQ15S	120	35×15	0.20	0.81	ESLM401VSN121MA15S	

KLM Series

- 15mm height snap-ins
- Endurance with ripple current : 2,000 hours at 105°C
- Non solvent resistant type
- RoHS Compliant

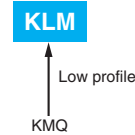

◆ SPECIFICATIONS

Items	Characteristics	
Category Temperature Range	-25 to +105°C	
Rated Voltage Range	160 to 400V _{dc}	
Capacitance Tolerance	±20% (M) (at 20°C, 120Hz)	
Leakage Current	I ≤ 3√CV Where, I : Max. leakage current (µA), C : Nominal capacitance (µF), V : Rated voltage (V) (at 20°C after 5 minutes)	
Dissipation Factor (tan δ)	Rated voltage (V _{dc})	160 to 400V
	tan δ (Max.)	0.20 (at 20°C, 120Hz)
Low Temperature Characteristics (Max. Impedance Ratio)	Rated voltage (V _{dc})	160 to 400V
	Z (-25°C)/Z (+20°C)	4 (at 120Hz)
Endurance	The following specifications shall be satisfied when the capacitors are restored to 20°C after subjected to DC voltage with the rated ripple current is applied (the peak voltage shall not exceed the rated voltage) for 2,000 hours at 105°C.	
	Capacitance change	≤ ±20% of the initial value
	D.F. (tan δ)	≤ 200% of the initial specified value
	Leakage current	≤ The initial specified value
Shelf Life	The following specifications shall be satisfied when the capacitors are restored to 20°C after exposing them for 1,000 hours at 105°C without voltage applied. Before the measurement, the capacitor shall be preconditioned by applying voltage according to Item 4.1 of JIS C 5101-4.	
	Capacitance change	≤ ±15% of the initial value
	D.F. (tan δ)	≤ 150% of the initial specified value
	Leakage current	≤ The initial specified value

◆ DIMENSIONS [mm]

- Terminal Code : VS

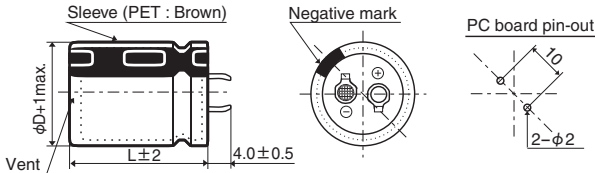

The standard design has no plastic disc.

◆ PART NUMBERING SYSTEM

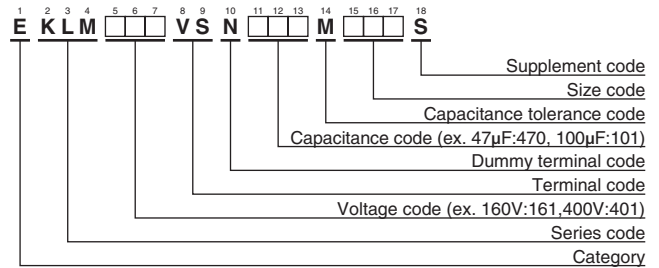

Please refer to "Product code guide (snap-in type)"

◆ STANDARD RATINGS

WV (V _{dc})	Cap (µF)	Case size φD×L(mm)	tan δ	Rated ripple current (Arms/105°C, 120Hz)	Part No.
160	150	22×15	0.20	0.68	EKLM161VSN151MP15S
	180	25.4×15	0.20	0.79	EKLM161VSN181MQ15S
	220	25.4×15	0.20	0.88	EKLM161VSN221MQ15S
	270	30×15	0.20	0.96	EKLM161VSN271MR15S
	330	30×15	0.20	1.06	EKLM161VSN331MR15S
180	390	35×15	0.20	1.20	EKLM161VSN391MA15S
	120	22×15	0.20	0.61	EKLM181VSN121MP15S
	150	25.4×15	0.20	0.73	EKLM181VSN151MQ15S
	180	25.4×15	0.20	0.79	EKLM181VSN181MQ15S
	220	30×15	0.20	0.86	EKLM181VSN221MR15S
200	270	30×15	0.20	0.96	EKLM181VSN271MR15S
	330	35×15	0.20	1.10	EKLM181VSN331MA15S
	390	35×15	0.20	1.17	EKLM181VSN391MA15S
	120	22×15	0.20	0.61	EKLM201VSN121MP15S
	150	25.4×15	0.20	0.73	EKLM201VSN151MQ15S
200	180	30×15	0.20	0.79	EKLM201VSN181MR15S
	220	30×15	0.20	0.86	EKLM201VSN221MR15S
	270	30×15	0.20	0.96	EKLM201VSN271MR15S
	330	35×15	0.20	1.10	EKLM201VSN331MA15S
	390	35×15	0.20	1.17	EKLM201VSN391MA15S
	82	22×15	0.20	0.50	EKLM251VSN820MP15S
	100	25.4×15	0.20	0.59	EKLM251VSN101MQ15S
	120	25.4×15	0.20	0.65	EKLM251VSN121MQ15S
	150	30×15	0.20	0.71	EKLM251VSN151MR15S
	180	30×15	0.20	0.79	EKLM251VSN181MR15S
250	220	35×15	0.20	0.90	EKLM251VSN221MA15S
	39	22×15	0.20	0.35	EKLM401VSN390MP15S
	47	25.4×15	0.20	0.40	EKLM401VSN470MQ15S
	56	25.4×15	0.20	0.44	EKLM401VSN560MQ15S
	68	30×15	0.20	0.46	EKLM401VSN680MR15S
	82	30×15	0.20	0.51	EKLM401VSN820MR15S
	100	35×15	0.20	0.56	EKLM401VSN101MA15S
	120	35×15	0.20	0.62	EKLM401VSN121MA15S

◆ RATED RIPPLE CURRENT MULTIPLIERS

- Frequency Multipliers

Frequency (Hz)	50	120	300	1k	10k	50k
160 to 250V _{dc}	0.81	1.00	1.17	1.32	1.45	1.50
400V _{dc}	0.77	1.00	1.16	1.30	1.41	1.43

The endurance of capacitors is reduced with internal heating produced by ripple current at the rate of halving the lifetime with every 5°C rise. When long life performance is required in actual use, the rms ripple current has to be reduced.

New!

TXH Series

- Endurance with ripple current : 10,000 hours at 105°C
- Non solvent resistant type
- RoHS Compliant

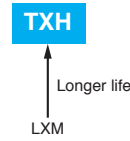

◆SPECIFICATIONS

Items	Characteristics		
Category	-25 to +105°C		
Temperature Range	-25 to +105°C		
Rated Voltage Range	200 to 450V _{dc}		
Capacitance Tolerance	±20% (M) (at 20°C, 120Hz)		
Leakage Current	$I \leq 3\sqrt{CV}$ Where, I : Max. leakage current (µA), C : Nominal capacitance (µF), V : Rated voltage (V) (at 20°C after 5 minutes)		
Dissipation Factor (tanδ)	Rated voltage (V _{dc})	200 to 400V	450V
	tan δ (Max.)	0.15	0.20
Low Temperature Characteristics (Max. Impedance Ratio)	Rated voltage (V _{dc})	200 to 400V	450V
	Z (-25°C)/Z (+20°C)	4	8
Endurance	The following specifications shall be satisfied when the capacitors are restored to 20°C after subjected to DC voltage with the rated ripple current is applied (the peak voltage shall not exceed the rated voltage) for 10,000 hours at 105°C.		
	Capacitance change	≤±20% of the initial value	
	D.F. (tanδ)	≤200% of the initial specified value	
	Leakage current	≤The initial specified value	
Shelf Life	The following specifications shall be satisfied when the capacitors are restored to 20°C after exposing them for 1,000 hours at 105°C without voltage applied. Before the measurement, the capacitor shall be preconditioned by applying voltage according to Item 4.1 of JIS C 5101-4.		
	Capacitance change	≤±15% of the initial value	
	D.F. (tanδ)	≤150% of the initial specified value	
	Leakage current	≤The initial specified value	

◆DIMENSIONS [mm]

●Terminal Code : VS (φ30 to φ40) : Standard

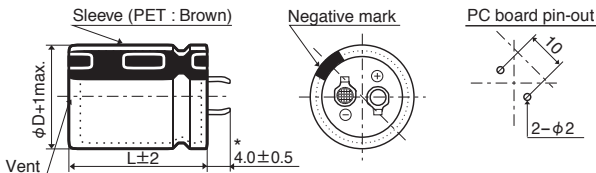

* φD=40mm : 3.5±0.5mm

The standard design has no plastic disc.

●Terminal Code : LI (φ35, φ40)

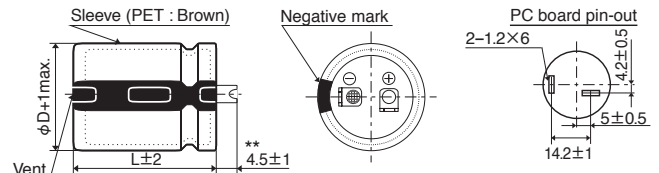

** φD=40mm : 4.0±1

◆PART NUMBERING SYSTEM

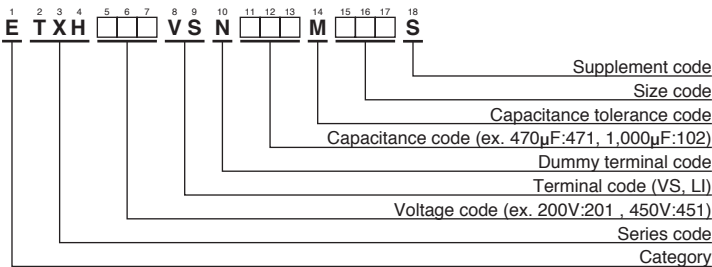

Please refer to "Product code guide (snap-in type)"

New!

TXH Series

◆STANDARD RATINGS

WV (V _{dc})	Cap (μF)	Case size φD×L(mm)	tan δ	Rated ripple current (Arms/105°C,120Hz)	Part No.
200	560	30×30	0.15	1.50	ETXH201VSN561MR30S
	680	30×35	0.15	1.70	ETXH201VSN681MR35S
	820	30×40	0.15	2.00	ETXH201VSN821MR40S
	820	35×30	0.15	2.00	ETXH201VSN821MA30S
	1,000	30×45	0.15	2.20	ETXH201VSN102MR45S
	1,000	35×35	0.15	2.20	ETXH201VSN102MA35S
	1,000	40×30	0.15	2.17	ETXH201VSN102MB30S
	1,200	35×40	0.15	2.40	ETXH201VSN122MA40S
	1,200	40×35	0.15	2.45	ETXH201VSN122MB35S
	1,500	35×50	0.15	2.81	ETXH201VSN152MA50S
	1,500	40×40	0.15	2.79	ETXH201VSN152MB40S
	1,800	40×50	0.15	3.24	ETXH201VSN182MB50S
250	390	30×30	0.15	1.30	ETXH251VSN391MR30S
	470	30×35	0.15	1.42	ETXH251VSN471MR35S
	560	35×30	0.15	1.58	ETXH251VSN561MA30S
	680	30×45	0.15	1.80	ETXH251VSN681MR45S
	680	35×35	0.15	1.76	ETXH251VSN681MA35S
	820	30×50	0.15	2.03	ETXH251VSN821MR50S
	820	35×40	0.15	2.01	ETXH251VSN821MA40S
	820	40×30	0.15	1.96	ETXH251VSN821MB30S
	1,000	35×45	0.15	2.30	ETXH251VSN102MA45S
	1,000	40×35	0.15	2.27	ETXH251VSN102MB35S
	1,200	35×50	0.15	2.55	ETXH251VSN122MA50S
	1,200	40×40	0.15	2.53	ETXH251VSN122MB40S
1,500	40×50	0.15	2.96	ETXH251VSN152MB50S	
1,800	40×60	0.15	3.39	ETXH251VSN182MB60S	
400	220	30×35	0.15	1.00	ETXH401VSN221MR35S
	270	30×40	0.15	1.15	ETXH401VSN271MR40S
	270	35×30	0.15	1.13	ETXH401VSN271MA30S
	330	30×45	0.15	1.29	ETXH401VSN331MR45S
	330	35×35	0.15	1.26	ETXH401VSN331MA35S
	330	40×30	0.15	1.28	ETXH401VSN331MB30S
	390	30×50	0.15	1.44	ETXH401VSN391MR50S
	390	35×40	0.15	1.43	ETXH401VSN391MA40S
	470	35×45	0.15	1.60	ETXH401VSN471MA45S
	470	40×35	0.15	1.58	ETXH401VSN471MB35S
	560	35×50	0.15	1.79	ETXH401VSN561MA50S
	560	40×40	0.15	1.78	ETXH401VSN561MB40S
680	40×50	0.15	2.05	ETXH401VSN681MB50S	
820	40×60	0.15	2.36	ETXH401VSN821MB60S	
450	220	30×40	0.20	1.04	ETXH451VSN221MR40S
	220	35×30	0.20	1.02	ETXH451VSN221MA30S
	270	30×45	0.20	1.19	ETXH451VSN271MR45S
	270	35×35	0.20	1.16	ETXH451VSN271MA35S
	330	30×50	0.20	1.33	ETXH451VSN331MR50S
	330	35×40	0.20	1.32	ETXH451VSN331MA40S
	390	35×45	0.20	1.48	ETXH451VSN391MA45S
	470	35×50	0.20	1.64	ETXH451VSN471MA50S
	560	40×60	0.20	1.98	ETXH451VSN561MB60S

◆RATED RIPPLE CURRENT MULTIPLIERS

●Frequency Multipliers

Frequency(Hz)	50	120	300	1k	10k	50k
200, 250V _{dc}	0.81	1.00	1.17	1.32	1.45	1.50
400, 450V _{dc}	0.77	1.00	1.16	1.30	1.41	1.43

The endurance of capacitors is reduced with internal heating produced by ripple current at the rate of halving the lifetime with every 5°C rise. When long life performance is required in actual use, the rms ripple current has to be reduced.

LXM Series

- Endurance with ripple current : 7,000 hours at 105°C
- Non solvent resistant type
- RoHS Compliant

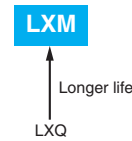

◆SPECIFICATIONS

Items	Characteristics		
Category	-25 to +105°C		
Temperature Range			
Rated Voltage Range	160 to 450V _{dc}		
Capacitance Tolerance	±20% (M) (at 20°C, 120Hz)		
Leakage Current	I ≤ 3√CV Where, I : Max. leakage current (µA), C : Nominal capacitance (µF), V : Rated voltage (V) (at 20°C after 5 minutes)		
Dissipation Factor (tanδ)	Rated voltage (V _{dc})	160 to 400V	420 & 450V
	tanδ (Max.)	0.15	0.20
Low Temperature Characteristics (Max. Impedance Ratio)	Rated voltage (V _{dc})	160 to 400V	420 & 450V
	Z (-25°C)/Z (+20°C)	4	8
Endurance	The following specifications shall be satisfied when the capacitors are restored to 20°C after subjected to DC voltage with the rated ripple current is applied (the peak voltage shall not exceed the rated voltage) for 7,000 hours at 105°C.		
	Capacitance change	≤±20% of the initial value	
	D.F. (tanδ)	≤250% of the initial specified value	
	Leakage current	≤The initial specified value	
Shelf Life	The following specifications shall be satisfied when the capacitors are restored to 20°C after exposing them for 1,000 hours at 105°C without voltage applied. Before the measurement, the capacitor shall be preconditioned by applying voltage according to Item 4.1 of JIS C 5101-4.		
	Capacitance change	≤±15% of the initial value	
	D.F. (tanδ)	≤150% of the initial specified value	
	Leakage current	≤The initial specified value	

◆DIMENSIONS [mm]

●Terminal Code : VS (φ22 to φ35) : Standard

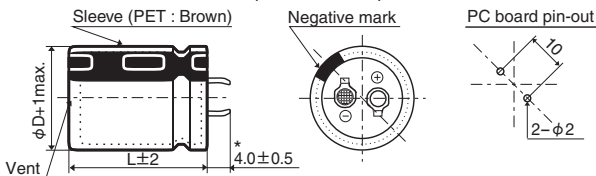

*φD=35mm : 3.5±0.5mm

The standard design has no plastic disc.

●Terminal Code : LI (φ35)

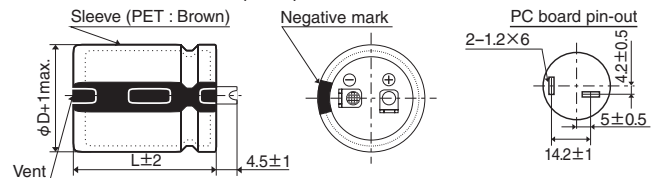

◆PART NUMBERING SYSTEM

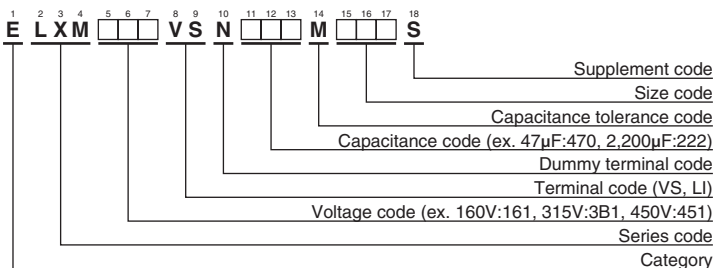

Please refer to "Product code guide (snap-in type)"

◆STANDARD RATINGS

WV (Vdc)	Cap (μF)	Case size φD×L(mm)	tanδ	Rated ripple current (Arms/105°C,120Hz)	Part No.	WV (Vdc)	Cap (μF)	Case size φD×L(mm)	tanδ	Rated ripple current (Arms/105°C,120Hz)	Part No.
160	330	22×25	0.15	1.11	ELXM161VSN331MP25S	220	220	22×25	0.15	0.90	ELXM221VSN221MP25S
	390	22×30	0.15	1.26	ELXM161VSN391MP30S		270	22×30	0.15	1.05	ELXM221VSN271MP30S
	470	22×30	0.15	1.39	ELXM161VSN471MP30S		330	22×35	0.15	1.19	ELXM221VSN331MP35S
	470	25.4×25	0.15	1.38	ELXM161VSN471MQ25S		330	25.4×25	0.15	1.16	ELXM221VSN331MQ25S
	560	22×35	0.15	1.55	ELXM161VSN561MP35S		390	22×40	0.15	1.33	ELXM221VSN391MP40S
	560	25.4×30	0.15	1.55	ELXM161VSN561MQ30S		390	25.4×30	0.15	1.29	ELXM221VSN391MQ30S
	680	22×40	0.15	1.75	ELXM161VSN681MP40S		470	22×45	0.15	1.49	ELXM221VSN471MP45S
	680	25.4×35	0.15	1.78	ELXM161VSN681MQ35S		470	25.4×35	0.15	1.48	ELXM221VSN471MQ35S
	680	30×25	0.15	1.74	ELXM161VSN681MR25S		470	30×25	0.15	1.45	ELXM221VSN471MR25S
	820	22×50	0.15	1.97	ELXM161VSN821MP50S		560	22×50	0.15	1.63	ELXM221VSN561MP50S
	820	25.4×40	0.15	2.01	ELXM161VSN821MQ40S		560	25.4×40	0.15	1.71	ELXM221VSN561MQ40S
	820	30×30	0.15	1.96	ELXM161VSN821MR30S		560	30×30	0.15	1.62	ELXM221VSN561MR30S
	1,000	25.4×45	0.15	2.27	ELXM161VSN102MQ45S		680	25.4×45	0.15	1.87	ELXM221VSN681MQ45S
	1,000	30×35	0.15	2.26	ELXM161VSN102MR35S		680	30×35	0.15	1.86	ELXM221VSN681MR35S
	1,200	25.4×50	0.15	2.54	ELXM161VSN122MQ50S		820	25.4×50	0.15	2.10	ELXM221VSN821MQ50S
	1,200	30×40	0.15	2.56	ELXM161VSN122MR40S		820	30×40	0.15	2.12	ELXM221VSN821MR40S
	1,200	35×30	0.15	2.52	ELXM161VSN122MA30S		820	35×30	0.15	2.08	ELXM221VSN821MA30S
	1,500	30×45	0.15	2.96	ELXM161VSN152MR45S		1,000	30×50	0.15	2.48	ELXM221VSN102MR50S
	1,500	35×35	0.15	2.89	ELXM161VSN152MA35S		1,000	35×40	0.15	2.46	ELXM221VSN102MA40S
	1,800	30×50	0.15	3.32	ELXM161VSN182MR50S		1,200	35×45	0.15	2.78	ELXM221VSN122MA45S
1,800	35×40	0.15	3.30	ELXM161VSN182MA40S	1,500	35×50	0.15	3.20	ELXM221VSN152MA50S		
2,200	35×50	0.15	3.87	ELXM161VSN222MA50S	250	180	22×25	0.15	0.82	ELXM251VSN181MP25S	
180	270	22×25	0.15	1.00		ELXM181VSN271MP25S	220	22×30	0.15	0.95	ELXM251VSN221MP30S
	330	22×30	0.15	1.16		ELXM181VSN331MP30S	270	22×35	0.15	1.08	ELXM251VSN271MP35S
	390	22×30	0.15	1.26		ELXM181VSN391MP30S	270	25.4×25	0.15	1.05	ELXM251VSN271MQ25S
	390	25.4×25	0.15	1.26		ELXM181VSN391MQ25S	330	22×40	0.15	1.22	ELXM251VSN331MP40S
	470	22×35	0.15	1.42		ELXM181VSN471MP35S	330	25.4×30	0.15	1.19	ELXM251VSN331MQ30S
	470	25.4×30	0.15	1.42		ELXM181VSN471MQ30S	390	22×45	0.15	1.36	ELXM251VSN391MP45S
	560	22×40	0.15	1.59		ELXM181VSN561MP40S	390	25.4×35	0.15	1.35	ELXM251VSN391MQ35S
	560	25.4×30	0.15	1.55		ELXM181VSN561MQ30S	390	30×25	0.15	1.32	ELXM251VSN391MR25S
	560	30×25	0.15	1.58		ELXM181VSN561MR25S	470	22×50	0.15	1.49	ELXM251VSN471MP50S
	680	22×45	0.15	1.79		ELXM181VSN681MP45S	470	25.4×40	0.15	1.52	ELXM251VSN471MQ40S
	680	25.4×35	0.15	1.78		ELXM181VSN681MQ35S	470	30×30	0.15	1.49	ELXM251VSN471MR30S
	680	30×30	0.15	1.79		ELXM181VSN681MR30S	560	25.4×45	0.15	1.70	ELXM251VSN561MQ45S
	820	25.4×40	0.15	2.01		ELXM181VSN821MQ40S	560	30×35	0.15	1.69	ELXM251VSN561MR35S
	820	30×35	0.15	2.04		ELXM181VSN821MR35S	680	25.4×50	0.15	1.91	ELXM251VSN681MQ50S
	1,000	25.4×50	0.15	2.32		ELXM181VSN102MQ50S	680	30×40	0.15	1.93	ELXM251VSN681MR40S
	1,000	30×35	0.15	2.26		ELXM181VSN102MR35S	680	35×30	0.15	1.90	ELXM251VSN681MA30S
	1,000	35×30	0.15	2.30		ELXM181VSN102MA30S	820	30×45	0.15	2.19	ELXM251VSN821MR45S
	1,200	30×45	0.15	2.65		ELXM181VSN122MR45S	820	35×35	0.15	2.13	ELXM251VSN821MA35S
	1,200	35×35	0.15	2.58		ELXM181VSN122MA35S	1,000	35×40	0.15	2.46	ELXM251VSN102MA40S
	1,500	30×50	0.15	3.03	ELXM181VSN152MR50S	1,200	35×50	0.15	2.86	ELXM251VSN122MA50S	
1,500	35×40	0.15	3.01	ELXM181VSN152MA40S	315	100	22×25	0.15	0.67	ELXM3B1VSN101MP25S	
1,800	35×45	0.15	3.41	ELXM181VSN182MA45S		120	22×30	0.15	0.77	ELXM3B1VSN121MP30S	
2,200	35×50	0.15	3.87	ELXM181VSN222MA50S		150	22×30	0.15	0.86	ELXM3B1VSN151MP30S	
200	220	22×25	0.15	0.90		ELXM201VSN221MP25S	150	25.4×25	0.15	0.85	ELXM3B1VSN151MQ25S
	270	22×30	0.15	1.05		ELXM201VSN271MP30S	180	22×35	0.15	0.96	ELXM3B1VSN181MP35S
	330	22×30	0.15	1.16		ELXM201VSN331MP30S	180	25.4×30	0.15	0.96	ELXM3B1VSN181MQ30S
	330	25.4×25	0.15	1.16		ELXM201VSN331MQ25S	220	22×40	0.15	1.09	ELXM3B1VSN221MP40S
	390	22×35	0.15	1.29		ELXM201VSN391MP35S	220	25.4×30	0.15	1.06	ELXM3B1VSN221MQ30S
	390	25.4×30	0.15	1.29		ELXM201VSN391MQ30S	220	30×25	0.15	1.08	ELXM3B1VSN221MR25S
	470	22×40	0.15	1.46		ELXM201VSN471MP40S	270	22×45	0.15	1.24	ELXM3B1VSN271MP45S
	470	25.4×30	0.15	1.42		ELXM201VSN471MQ30S	270	25.4×35	0.15	1.23	ELXM3B1VSN271MQ35S
	470	30×25	0.15	1.45		ELXM201VSN471MR25S	270	30×30	0.15	1.23	ELXM3B1VSN271MR30S
	560	22×45	0.15	1.63		ELXM201VSN561MP45S	330	25.4×40	0.15	1.40	ELXM3B1VSN331MQ40S
	560	25.4×35	0.15	1.62		ELXM201VSN561MQ35S	330	30×35	0.15	1.42	ELXM3B1VSN331MR35S
	560	30×30	0.15	1.62		ELXM201VSN561MR30S	330	35×30	0.15	1.45	ELXM3B1VSN331MA30S
	680	25.4×40	0.15	1.83		ELXM201VSN681MQ40S	390	25.4×50	0.15	1.59	ELXM3B1VSN391MQ50S
	680	30×30	0.15	1.79		ELXM201VSN681MR30S	390	30×35	0.15	1.54	ELXM3B1VSN391MR35S
	820	25.4×45	0.15	2.06		ELXM201VSN821MQ45S	390	35×30	0.15	1.57	ELXM3B1VSN391MA30S
	820	30×35	0.15	2.04		ELXM201VSN821MR35S	470	30×45	0.15	1.81	ELXM3B1VSN471MR45S
	1,000	30×45	0.15	2.42		ELXM201VSN102MR45S	470	35×35	0.15	1.77	ELXM3B1VSN471MA35S
	1,000	35×30	0.15	2.30	ELXM201VSN102MA30S	560	30×50	0.15	2.03	ELXM3B1VSN561MR50S	
	1,200	30×50	0.15	2.71	ELXM201VSN122MR50S	560	35×40	0.15	2.02	ELXM3B1VSN561MA40S	
	1,200	35×40	0.15	2.70	ELXM201VSN122MA40S	680	35×45	0.15	2.29	ELXM3B1VSN681MA45S	
1,500	35×45	0.15	3.11	ELXM201VSN152MA45S	820	35×50	0.15	2.59	ELXM3B1VSN821MA50S		
1,800	35×50	0.15	3.50	ELXM201VSN182MA50S							

◆STANDARD RATINGS

WV (Vdc)	Cap (μF)	Case size φD×L(mm)	tanδ	Rated ripple current (Arms/105°C,120Hz)	Part No.	WV (Vdc)	Cap (μF)	Case size φD×L(mm)	tanδ	Rated ripple current (Arms/105°C,120Hz)	Part No.
350	100	22×25	0.15	0.67	ELXM351VSN101MP25S	420	56	22×25	0.20	0.50	ELXM421VSN560MP25S
	120	22×30	0.15	0.77	ELXM351VSN121MP30S		68	22×30	0.20	0.58	ELXM421VSN680MP30S
	120	25.4×25	0.15	0.76	ELXM351VSN121MQ25S		82	22×30	0.20	0.63	ELXM421VSN820MP30S
	150	22×35	0.15	0.88	ELXM351VSN151MP35S		82	25.4×25	0.20	0.63	ELXM421VSN820MQ25S
	150	25.4×30	0.15	0.88	ELXM351VSN151MQ30S		100	22×35	0.20	0.72	ELXM421VSN101MP35S
	180	22×40	0.15	0.99	ELXM351VSN181MP40S		100	25.4×30	0.20	0.72	ELXM421VSN101MQ30S
	180	25.4×30	0.15	0.96	ELXM351VSN181MQ30S		120	22×40	0.20	0.81	ELXM421VSN121MP40S
	180	30×25	0.15	0.98	ELXM351VSN181MR25S		120	25.4×30	0.20	0.79	ELXM421VSN121MQ30S
	220	22×45	0.15	1.12	ELXM351VSN221MP45S		120	30×25	0.20	0.80	ELXM421VSN121MR25S
	220	25.4×35	0.15	1.11	ELXM351VSN231MQ35S		150	22×45	0.20	0.92	ELXM421VSN151MP45S
	220	30×30	0.15	1.11	ELXM351VSN221MR30S		150	25.4×35	0.20	0.92	ELXM421VSN151MQ35S
	270	25.4×40	0.15	1.26	ELXM351VSN271MQ40S		150	30×30	0.20	0.92	ELXM421VSN151MR30S
	270	30×35	0.15	1.28	ELXM351VSN271MR35S		180	25.4×40	0.20	1.03	ELXM421VSN181MQ40S
	330	25.4×45	0.15	1.40	ELXM351VSN331MQ45S		180	30×35	0.20	1.05	ELXM421VSN181MR35S
	330	30×35	0.15	1.42	ELXM351VSN331MR35S		220	25.4×50	0.20	1.19	ELXM421VSN221MQ50S
	330	35×30	0.15	1.45	ELXM351VSN331MA30S		220	30×35	0.20	1.16	ELXM421VSN221MR35S
	390	30×40	0.15	1.60	ELXM351VSN391MR40S		220	35×30	0.20	1.18	ELXM421VSN221MA30S
	390	35×35	0.15	1.61	ELXM351VSN391MA35S		270	30×45	0.20	1.38	ELXM421VSN271MR45S
	470	30×50	0.15	1.86	ELXM351VSN471MR50S		270	35×35	0.20	1.34	ELXM421VSN271MA35S
	470	35×40	0.15	1.85	ELXM351VSN471MA40S		330	30×50	0.20	1.56	ELXM421VSN331MR50S
560	35×40	0.15	2.02	ELXM351VSN561MA40S	330	35×40	0.20	1.55	ELXM421VSN331MA40S		
680	35×50	0.15	2.36	ELXM351VSN681MA50S	390	35×45	0.20	1.74	ELXM421VSN391MA45S		
400	68	22×25	0.15	0.55	ELXM401VSN680MP25S	470	35×50	0.20	1.96	ELXM421VSN471MA50S	
	82	22×30	0.15	0.63	ELXM401VSN820MP30S	47	22×25	0.20	0.46	ELXM451VSN470MP25S	
	100	22×30	0.15	0.70	ELXM401VSN101MP30S	56	22×30	0.20	0.52	ELXM451VSN560MP30S	
	100	25.4×25	0.15	0.70	ELXM401VSN101MQ25S	68	22×30	0.20	0.58	ELXM451VSN680MP30S	
	120	22×35	0.15	0.79	ELXM401VSN121MP35S	68	25.4×25	0.20	0.58	ELXM451VSN680MQ25S	
	120	25.4×30	0.15	0.79	ELXM401VSN121MQ30S	82	22×35	0.20	0.65	ELXM451VSN820MP35S	
	150	22×40	0.15	0.90	ELXM401VSN151MP40S	82	25.4×30	0.20	0.65	ELXM451VSN820MQ30S	
	150	25.4×30	0.15	0.88	ELXM401VSN151MQ30S	100	22×40	0.20	0.74	ELXM451VSN101MP40S	
	150	30×25	0.15	0.90	ELXM401VSN151MR25S	100	25.4×30	0.20	0.72	ELXM451VSN101MQ30S	
	180	22×45	0.15	0.99	ELXM401VSN181MP45S	100	30×25	0.20	0.73	ELXM451VSN101MR25S	
	180	25.4×35	0.15	1.01	ELXM401VSN181MQ35S	120	22×45	0.20	0.83	ELXM451VSN121MP45S	
	180	30×30	0.15	1.01	ELXM401VSN181MR30S	120	25.4×35	0.20	0.82	ELXM451VSN121MQ35S	
	220	25.4×40	0.15	1.14	ELXM401VSN221MQ40S	120	30×30	0.20	0.82	ELXM451VSN121MR30S	
	220	30×35	0.15	1.16	ELXM401VSN221MR35S	150	25.4×40	0.20	0.94	ELXM451VSN151MQ40S	
	270	25.4×50	0.15	1.32	ELXM401VSN271MQ50S	150	30×35	0.20	0.96	ELXM451VSN151MR35S	
	270	30×40	0.15	1.33	ELXM401VSN271MR40S	180	25.4×45	0.20	1.06	ELXM451VSN181MQ45S	
	270	35×30	0.15	1.31	ELXM401VSN271MA30S	180	30×35	0.20	1.05	ELXM451VSN181MR35S	
	330	30×45	0.15	1.52	ELXM401VSN331MR45S	180	35×30	0.20	1.07	ELXM451VSN181MA30S	
	330	35×35	0.15	1.48	ELXM401VSN331MA35S	220	30×40	0.20	1.20	ELXM451VSN221MR40S	
	390	30×50	0.15	1.69	ELXM401VSN391MR50S	220	35×35	0.20	1.21	ELXM451VSN221MA35S	
390	35×40	0.15	1.68	ELXM401VSN391MA40S	270	30×50	0.20	1.41	ELXM451VSN271MR50S		
470	35×45	0.15	1.91	ELXM401VSN471MA45S	270	35×40	0.20	1.40	ELXM451VSN271MA40S		
560	35×50	0.15	2.14	ELXM401VSN561MA50S	330	35×45	0.20	1.60	ELXM451VSN331MA45S		
					390	35×50	0.20	1.79	ELXM451VSN391MA50S		

◆RATED RIPPLE CURRENT MULTIPLIERS

●Frequency Multipliers

Frequency(Hz)	50	120	300	1k	10k	50k
160 to 250V _{dc}	0.81	1.00	1.17	1.32	1.45	1.50
315 to 450V _{dc}	0.77	1.00	1.16	1.30	1.41	1.43

The endurance of capacitors is reduced with internal heating produced by ripple current at the rate of halving the lifetime with every 5°C rise. When long life performance is required in actual use, the rms ripple current has to be reduced.

Upgrade!

LXS Series

- For solar power generation
- Endurance with ripple current : 5,000 hours at 105°C
- Rated voltage range : 160 to 500V
- Downsized from LXQ series
- Non solvent resistant type
- RoHS Compliant

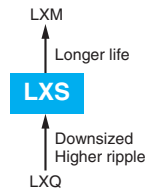

500V
Lineup!



SPECIFICATIONS

Items	Characteristics		
Category	-25 to +105°C		
Temperature Range	-25 to +105°C		
Rated Voltage Range	160 to 500V _{dc}		
Capacitance Tolerance	±20% (M) (at 20°C, 120Hz)		
Leakage Current	$I \leq 3\sqrt{CV}$ Where, I : Max. leakage current (µA), C : Nominal capacitance (µF), V : Rated voltage (V) (at 20°C after 5 minutes)		
Dissipation Factor (tanδ)	Rated voltage (V _{dc})	160 to 400V	420 to 500V
	tanδ (Max.)	0.15	0.20
Low Temperature Characteristics (Max. Impedance Ratio)	Rated voltage (V _{dc})	160 to 400V	420 to 500V
	Z(-25°C)/Z(+20°C)	4	8
Endurance	The following specifications shall be satisfied when the capacitors are restored to 20°C after subjected to DC voltage with the rated ripple current is applied (the peak voltage shall not exceed the rated voltage) for 5,000 hours at 105°C.		
	Capacitance change	≤±20% of the initial value	
	D.F. (tanδ)	≤200% of the initial specified value (500V _{dc} : ≤250%)	
	Leakage current	≤The initial specified value	
Shelf Life	The following specifications shall be satisfied when the capacitors are restored to 20°C after exposing them for 1,000 hours at 105°C without voltage applied. Before the measurement, the capacitor shall be preconditioned by applying voltage according to Item 4.1 of JIS C 5101-4.		
	Capacitance change	≤±15% of the initial value	
	D.F. (tanδ)	≤150% of the initial specified value	
	Leakage current	≤The initial specified value	

DIMENSIONS [mm]

● Terminal Code : VS (φ22 to φ35) : Standard

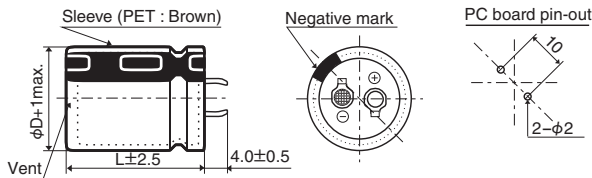

● Terminal Code : LI (φ30, φ35)

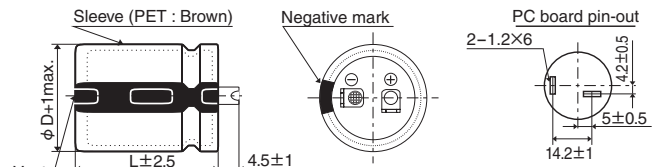

The standard design has no plastic disc.

PART NUMBERING SYSTEM

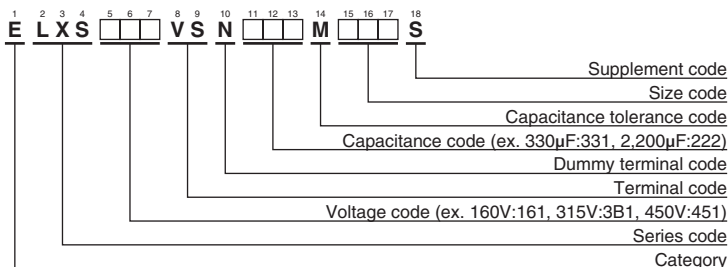

Please refer to "Product code guide (snap-in type)"



Upgrade!

LXS Series

◆STANDARD RATINGS

WV (Vdc)	Cap (μF)	Case size φD×L(mm)	tanδ	Rated ripple current (Arms/105°C,120Hz)	Part No.	WV (Vdc)	Cap (μF)	Case size φD×L(mm)	tanδ	Rated ripple current (Arms/105°C,120Hz)	Part No.	
160	470	22×25	0.15	1.47	ELXS161VSN471MP25S	200	1,500	35×35	0.15	3.36	ELXS201VSN152MA35S	
	680	22×30	0.15	1.86	ELXS161VSN681MP30S		1,800	30×50	0.15	3.72	ELXS201VSN182MR50S	
	680	25.4×25	0.15	1.84	ELXS161VSN681MQ25S		1,800	35×40	0.15	3.81	ELXS201VSN182MA40S	
	820	22×35	0.15	2.09	ELXS161VSN821MP35S		2,200	35×45	0.15	4.32	ELXS201VSN222MA45S	
	820	25.4×30	0.15	2.08	ELXS161VSN821MQ30S		2,700	35×50	0.15	4.88	ELXS201VSN272MA50S	
	1,000	22×40	0.15	2.35	ELXS161VSN102MP40S		250	270	22×25	0.15	1.11	ELXS251VSN271MP25S
	1,000	22×45	0.15	2.40	ELXS161VSN102MP45S			330	22×30	0.15	1.29	ELXS251VSN331MP30S
	1,000	25.4×35	0.15	2.40	ELXS161VSN102MQ35S			390	22×35	0.15	1.44	ELXS251VSN391MP35S
	1,000	30×25	0.15	2.50	ELXS161VSN102MR25S			390	25.4×25	0.15	1.40	ELXS251VSN391MQ25S
	1,200	22×50	0.15	2.69	ELXS161VSN122MP50S			470	22×40	0.15	1.61	ELXS251VSN471MP40S
	1,200	25.4×40	0.15	2.68	ELXS161VSN122MQ40S	470		25.4×30	0.15	1.57	ELXS251VSN471MQ30S	
	1,200	30×30	0.15	2.77	ELXS161VSN122MR30S	560		22×45	0.15	1.79	ELXS251VSN561MP45S	
	1,200	35×25	0.15	2.91	ELXS161VSN122MA25S	560		25.4×35	0.15	1.79	ELXS251VSN561MQ35S	
	1,500	25.4×45	0.15	3.05	ELXS161VSN152MQ45S	560		30×25	0.15	1.87	ELXS251VSN561MP25S	
	1,500	30×35	0.15	3.17	ELXS161VSN152MR35S	680		22×50	0.15	2.02	ELXS251VSN681MP50S	
	1,800	25.4×50	0.15	3.40	ELXS161VSN182MQ50S	680	25.4×40	0.15	2.02	ELXS251VSN681MQ40S		
	1,800	30×40	0.15	3.57	ELXS161VSN182MR40S	680	30×30	0.15	2.08	ELXS251VSN681MR30S		
	1,800	35×30	0.15	3.62	ELXS161VSN182MA30S	680	35×25	0.15	2.19	ELXS251VSN681MA25S		
	2,200	30×45	0.15	4.05	ELXS161VSN222MR45S	820	25.4×45	0.15	2.26	ELXS251VSN821MQ45S		
	2,200	30×50	0.15	4.11	ELXS161VSN222MR50S	820	25.4×50	0.15	2.29	ELXS251VSN821MQ50S		
2,200	35×35	0.15	4.07	ELXS161VSN222MA35S	820	30×35	0.15	2.34	ELXS251VSN821MR35S			
2,700	35×40	0.15	4.67	ELXS161VSN272MA40S	820	35×30	0.15	2.45	ELXS251VSN821MA30S			
2,700	35×45	0.15	4.78	ELXS161VSN272MA45S	1,000	30×40	0.15	2.66	ELXS251VSN102MR40S			
3,300	35×50	0.15	5.40	ELXS161VSN332MA50S	1,200	30×45	0.15	2.99	ELXS251VSN122MR45S			
180	390	22×25	0.15	1.34	ELXS181VSN391MP25S	1,200	30×50	0.15	3.04	ELXS251VSN122MR50S		
	560	22×30	0.15	1.68	ELXS181VSN561MP30S	1,200	35×35	0.15	3.00	ELXS251VSN122MA35S		
	560	25.4×25	0.15	1.67	ELXS181VSN561MQ25S	1,200	35×40	0.15	3.11	ELXS251VSN122MA40S		
	680	22×35	0.15	1.90	ELXS181VSN681MP35S	1,500	35×45	0.15	3.56	ELXS251VSN152MA45S		
	820	22×40	0.15	2.13	ELXS181VSN821MP40S	1,800	35×50	0.15	3.98	ELXS251VSN182MA50S		
	820	25.4×30	0.15	2.08	ELXS181VSN821MQ30S	315	180	22×25	0.15	0.95	ELXS3B1VSN181MP25S	
	820	25.4×35	0.15	2.17	ELXS181VSN821MQ35S		220	22×30	0.15	1.10	ELXS3B1VSN221MP30S	
	820	30×25	0.15	2.26	ELXS181VSN821MR25S		220	25.4×25	0.15	1.10	ELXS3B1VSN221MQ25S	
	1,000	22×45	0.15	2.40	ELXS181VSN102MP45S		270	22×35	0.15	1.24	ELXS3B1VSN271MP35S	
	1,000	22×50	0.15	2.45	ELXS181VSN102MP50S		270	25.4×30	0.15	1.25	ELXS3B1VSN271MQ30S	
	1,000	25.4×40	0.15	2.45	ELXS181VSN102MQ40S		330	22×40	0.15	1.40	ELXS3B1VSN331MP40S	
	1,000	30×30	0.15	2.52	ELXS181VSN102MR30S		330	30×25	0.15	1.43	ELXS3B1VSN331MR25S	
	1,000	35×25	0.15	2.66	ELXS181VSN102MA25S		390	22×45	0.15	1.56	ELXS3B1VSN391MP45S	
	1,200	25.4×45	0.15	2.73	ELXS181VSN122MQ45S		390	22×50	0.15	1.59	ELXS3B1VSN391MP50S	
	1,200	30×35	0.15	2.83	ELXS181VSN122MR35S		390	25.4×35	0.15	1.57	ELXS3B1VSN391MQ35S	
	1,500	25.4×50	0.15	3.10	ELXS181VSN152MQ50S	470	25.4×40	0.15	1.76	ELXS3B1VSN471MQ40S		
	1,500	30×40	0.15	3.26	ELXS181VSN152MR40S	470	25.4×45	0.15	1.79	ELXS3B1VSN471MQ45S		
	1,500	35×30	0.15	3.31	ELXS181VSN152MA30S	470	30×30	0.15	1.73	ELXS3B1VSN471MR30S		
	1,800	30×45	0.15	3.66	ELXS181VSN182MR45S	470	35×25	0.15	1.82	ELXS3B1VSN471MA25S		
	1,800	35×35	0.15	3.68	ELXS181VSN182MA35S	560	25.4×50	0.15	1.99	ELXS3B1VSN561MQ50S		
2,200	30×50	0.15	4.11	ELXS181VSN222MR50S	560	30×35	0.15	1.93	ELXS3B1VSN561MR35S			
2,200	35×40	0.15	4.22	ELXS181VSN222MA40S	560	35×30	0.15	2.02	ELXS3B1VSN561MA30S			
2,200	35×45	0.15	4.32	ELXS181VSN222MA45S	680	30×40	0.15	2.19	ELXS3B1VSN681MR40S			
2,700	35×50	0.15	4.88	ELXS181VSN272MA50S	680	30×45	0.15	2.25	ELXS3B1VSN681MR45S			
200	390	22×25	0.15	1.34	ELXS201VSN391MP25S	680	35×35	0.15	2.26	ELXS3B1VSN681MA35S		
	470	22×30	0.15	1.54	ELXS201VSN471MP30S	820	30×50	0.15	2.51	ELXS3B1VSN821MR50S		
	560	22×35	0.15	1.72	ELXS201VSN561MP35S	820	35×40	0.15	2.57	ELXS3B1VSN821MA40S		
	560	25.4×25	0.15	1.67	ELXS201VSN561MQ25S	1,000	35×45	0.15	2.91	ELXS3B1VSN102MA45S		
	680	22×40	0.15	1.94	ELXS201VSN681MP40S	1,200	35×50	0.15	3.25	ELXS3B1VSN122MA50S		
	680	25.4×30	0.15	1.89	ELXS201VSN681MQ30S	400	120	22×25	0.15	0.77	ELXS401VSN121MP25S	
	680	30×25	0.15	2.06	ELXS201VSN681MR25S		150	22×30	0.15	0.90	ELXS401VSN151MP30S	
	820	22×45	0.15	2.17	ELXS201VSN821MP45S		180	22×35	0.15	1.02	ELXS401VSN181MP35S	
	820	25.4×35	0.15	2.17	ELXS201VSN821MQ35S		180	25.4×25	0.15	0.99	ELXS401VSN181MQ25S	
	1,000	22×50	0.15	2.45	ELXS201VSN102MP50S		220	22×40	0.15	1.15	ELXS401VSN221MP40S	
	1,000	25.4×40	0.15	2.45	ELXS201VSN102MQ40S		220	25.4×30	0.15	1.13	ELXS401VSN221MQ30S	
	1,000	30×30	0.15	2.52	ELXS201VSN102MR30S		220	30×25	0.15	1.17	ELXS401VSN221MR25S	
	1,000	35×25	0.15	2.66	ELXS201VSN102MA25S		270	22×45	0.15	1.29	ELXS401VSN271MP45S	
	1,200	25.4×45	0.15	2.73	ELXS201VSN122MQ45S		270	22×50	0.15	1.32	ELXS401VSN271MP50S	
	1,200	25.4×50	0.15	2.78	ELXS201VSN122MQ50S		270	25.4×35	0.15	1.30	ELXS401VSN271MQ35S	
	1,200	30×35	0.15	2.83	ELXS201VSN122MR35S	330	25.4×40	0.15	1.47	ELXS401VSN331MQ40S		
	1,200	35×30	0.15	2.96	ELXS201VSN122MA30S	330	30×30	0.15	1.45	ELXS401VSN331MR30S		
	1,500	30×40	0.15	3.26	ELXS201VSN152MR40S	330	35×25	0.15	1.52	ELXS401VSN331MA25S		
	1,500	30×45	0.15	3.34	ELXS201VSN152MR45S	390	25.4×45	0.15	1.63	ELXS401VSN391MQ45S		

Product specifications in this catalog are subject to change without notice. Request our product specifications before purchase and/or use. Please use our products based on the information contained in this catalog and product specifications.

◆STANDARD RATINGS

WV (V _{dc})	Cap (μF)	Case size φD×L(mm)	tanδ	Rated ripple current (A _{rms} /105°C,120Hz)	Part No.	WV (V _{dc})	Cap (μF)	Case size φD×L(mm)	tanδ	Rated ripple current (A _{rms} /105°C,120Hz)	Part No.
400	390	25.4×50	0.15	1.66	ELXS401VSN391MQ50S	450	82	22×25	0.20	0.64	ELXS451VSN820MP25S
	390	30×35	0.15	1.61	ELXS401VSN391MR35S		120	22×30	0.20	0.81	ELXS451VSN121MP30S
	390	35×30	0.15	1.68	ELXS401VSN391MA30S		120	22×35	0.20	0.83	ELXS451VSN121MP35S
	470	30×40	0.15	1.82	ELXS401VSN471MR40S		120	25.4×25	0.20	0.81	ELXS451VSN121MQ25S
	470	35×35	0.15	1.88	ELXS401VSN471MA35S		150	22×40	0.20	0.94	ELXS451VSN151MP40S
	560	30×45	0.15	2.04	ELXS401VSN561MR45S		150	25.4×30	0.20	0.93	ELXS451VSN151MQ30S
	560	30×50	0.15	2.07	ELXS401VSN561MR50S		180	22×45	0.20	1.06	ELXS451VSN181MP45S
	560	35×40	0.15	2.13	ELXS401VSN561MA40S		180	25.4×35	0.20	1.06	ELXS451VSN181MQ35S
	680	35×45	0.15	2.40	ELXS401VSN681MA45S		180	30×25	0.20	1.06	ELXS451VSN181MR25S
	820	35×50	0.15	2.69	ELXS401VSN821MA50S		220	22×50	0.20	1.20	ELXS451VSN221MP50S
420	100	22×25	0.20	0.70	ELXS421VSN101MP25S	220	25.4×40	0.20	1.20	ELXS451VSN221MQ40S	
	120	22×30	0.20	0.81	ELXS421VSN121MP30S	220	30×30	0.20	1.18	ELXS451VSN221MR30S	
	120	25.4×25	0.20	0.81	ELXS421VSN121MQ25S	220	35×25	0.20	1.24	ELXS451VSN221MA25S	
	150	22×35	0.20	0.93	ELXS421VSN151MP35S	270	25.4×45	0.20	1.36	ELXS451VSN271MQ45S	
	180	22×40	0.20	1.04	ELXS421VSN181MP40S	270	25.4×50	0.20	1.38	ELXS451VSN271MQ50S	
	180	25.4×30	0.20	1.02	ELXS421VSN181MQ30S	270	30×35	0.20	1.34	ELXS451VSN271MR35S	
	180	30×25	0.20	1.06	ELXS421VSN181MR25S	270	35×30	0.20	1.40	ELXS451VSN271MA30S	
	220	22×45	0.20	1.17	ELXS421VSN221MP45S	330	30×40	0.20	1.52	ELXS451VSN331MR40S	
	220	22×50	0.20	1.20	ELXS421VSN221MP50S	390	30×45	0.20	1.70	ELXS451VSN391MR45S	
	220	25.4×35	0.20	1.18	ELXS421VSN221MQ35S	390	30×50	0.20	1.73	ELXS451VSN391MR50S	
	270	25.4×40	0.20	1.33	ELXS421VSN271MQ40S	390	35×35	0.20	1.71	ELXS451VSN391MA35S	
	270	25.4×45	0.20	1.36	ELXS421VSN271MQ45S	470	35×40	0.20	1.95	ELXS451VSN471MA40S	
	270	30×30	0.20	1.31	ELXS421VSN271MR30S	470	35×45	0.20	1.99	ELXS451VSN471MA45S	
	270	35×25	0.20	1.38	ELXS421VSN271MA25S	560	35×50	0.20	2.22	ELXS451VSN561MA50S	
	330	25.4×50	0.20	1.52	ELXS421VSN331MQ50S	100	30×25	0.20	0.82	ELXS501VSN101MR25S	
	330	30×35	0.20	1.48	ELXS421VSN331MR35S	120	30×30	0.20	0.91	ELXS501VSN121MR30S	
	330	35×30	0.20	1.55	ELXS421VSN331MA30S	120	35×25	0.20	0.88	ELXS501VSN121MA25S	
	390	30×40	0.20	1.66	ELXS421VSN391MR40S	150	30×35	0.20	1.04	ELXS501VSN151MR35S	
	390	30×45	0.20	1.70	ELXS421VSN391MR45S	180	30×40	0.20	1.17	ELXS501VSN181MR40S	
	390	35×35	0.20	1.71	ELXS421VSN391MA35S	180	35×30	0.20	1.10	ELXS501VSN181MA30S	
470	30×50	0.20	1.90	ELXS421VSN471MR50S	220	30×45	0.20	1.33	ELXS501VSN221MR45S		
470	35×40	0.20	1.95	ELXS421VSN471MA40S	220	35×35	0.20	1.23	ELXS501VSN221MA35S		
560	35×45	0.20	2.17	ELXS421VSN561MA45S	270	30×50	0.20	1.50	ELXS501VSN271MR50S		
680	35×50	0.20	2.45	ELXS421VSN681MA50S	270	35×40	0.20	1.42	ELXS501VSN271MA40S		
					330	35×45	0.20	1.60	ELXS501VSN331MA45S		
					390	35×50	0.20	1.78	ELXS501VSN391MA50S		
					470	35×60	0.20	2.03	ELXS501VSN471MA60S		

◆RATED RIPPLE CURRENT MULTIPLIERS

●Frequency Multipliers

Frequency (Hz)	50	120	300	1k	10k	50k
160 to 250V _{dc}	0.81	1.00	1.17	1.32	1.45	1.50
315 to 450V _{dc}	0.77	1.00	1.16	1.30	1.41	1.43
500V _{dc}	0.70	1.00	1.16	1.30	1.41	1.43

The endurance of capacitors is reduced with internal heating produced by ripple current at the rate of halving the lifetime with every 5°C rise. When long life performance is required in actual use, the rms ripple current has to be reduced.

LXQ Series

- Endurance with ripple current : 5,000 hours at 105°C
- Downsized and higher ripple version of LXG series
- Non solvent resistant type
- RoHS Compliant

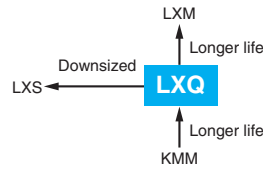

◆ SPECIFICATIONS

Items	Characteristics		
Category	Temperature Range		
Temperature Range	-25 to +105°C		
Rated Voltage Range	160 to 450V _{dc}		
Capacitance Tolerance	±20% (M) (at 20°C, 120Hz)		
Leakage Current	I ≤ 3√CV Where, I : Max. leakage current (µA), C : Nominal capacitance (µF), V : Rated voltage (V) (at 20°C after 5 minutes)		
Dissipation Factor (tanδ)	Rated voltage (V _{dc})	160 to 400V	420 & 450V
	tanδ (Max.)	0.15	0.20
Low Temperature Characteristics (Max. Impedance Ratio)	Rated voltage (V _{dc})	160 to 400V	420 & 450V
	Z(-25°C)/Z(+20°C)	4	8
Endurance	The following specifications shall be satisfied when the capacitors are restored to 20°C after subjected to DC voltage with the rated ripple current is applied (the peak voltage shall not exceed the rated voltage) for 5,000 hours at 105°C.		
	Capacitance change	≤ ±20% of the initial value	
	D.F. (tanδ)	≤ 200% of the initial specified value	
	Leakage current	≤ The initial specified value	
Shelf Life	The following specifications shall be satisfied when the capacitors are restored to 20°C after exposing them for 1,000 hours at 105°C without voltage applied. Before the measurement, the capacitor shall be preconditioned by applying voltage according to Item 4.1 of JIS C 5101-4.		
	Capacitance change	≤ ±15% of the initial value	
	D.F. (tanδ)	≤ 150% of the initial specified value	
	Leakage current	≤ The initial specified value	

◆ DIMENSIONS [mm]

- Terminal Code : VS (φ22 to φ35) : Standard

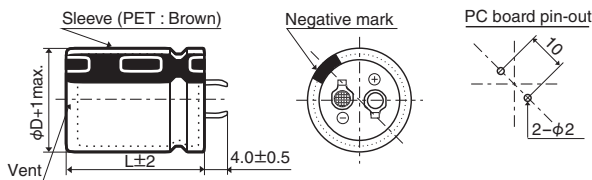

- Terminal Code : LI (φ30, φ35)

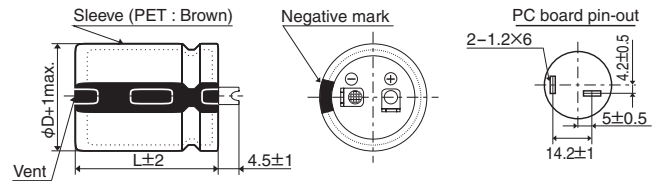

The standard design has no plastic disc.

◆ PART NUMBERING SYSTEM

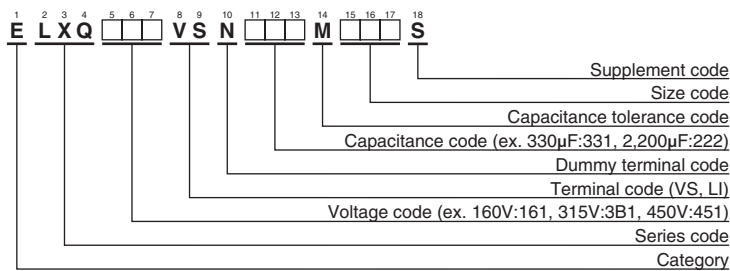

Please refer to "Product code guide (snap-in type)"



◆STANDARD RATINGS

WV (Vdc)	Cap (μF)	Case size φD×L(mm)	tanδ	Rated ripple current (Arms/105°C,120Hz)	Part No.	WV (Vdc)	Cap (μF)	Case size φD×L(mm)	tanδ	Rated ripple current (Arms/105°C,120Hz)	Part No.	
160	390	22×25	0.15	1.32	ELXQ161VSN391MP25S	200	1,200	30×50	0.15	2.88	ELXQ201VSN122MR50S	
	560	22×30	0.15	1.66	ELXQ161VSN561MP30S		1,200	35×35	0.15	2.88	ELXQ201VSN122MA35S	
	560	25.4×25	0.15	1.68	ELXQ161VSN561MQ25S		1,500	35×40	0.15	3.34	ELXQ201VSN152MA40S	
	680	22×35	0.15	1.87	ELXQ161VSN681MP35S		1,800	35×45	0.15	3.74	ELXQ201VSN182MA45S	
	680	25.4×30	0.15	1.88	ELXQ161VSN681MQ30S		1,800	35×50	0.15	3.82	ELXQ201VSN182MA50S	
	680	30×25	0.15	1.96	ELXQ161VSN681MR25S		220	270	22×25	0.15	1.10	ELXQ221VSN271MP25S
	820	22×40	0.15	2.09	ELXQ161VSN821MP40S			330	22×30	0.15	1.19	ELXQ221VSN331MP30S
	1,000	22×45	0.15	2.36	ELXQ161VSN102MP45S			390	25.4×25	0.15	1.39	ELXQ221VSN391MQ25S
	1,000	22×50	0.15	2.41	ELXQ161VSN102MP50S			470	22×35	0.15	1.55	ELXQ221VSN471MP35S
	1,000	25.4×35	0.15	2.38	ELXQ161VSN102MQ35S			470	25.4×30	0.15	1.56	ELXQ221VSN471MQ30S
	1,000	30×30	0.15	2.40	ELXQ161VSN102MR30S			470	30×25	0.15	1.63	ELXQ221VSN471MR25S
	1,000	35×25	0.15	2.55	ELXQ161VSN102MA25S			560	22×40	0.15	1.73	ELXQ221VSN561MP40S
	1,200	25.4×40	0.15	2.66	ELXQ161VSN122MQ40S			560	30×30	0.15	1.79	ELXQ221VSN561MR30S
	1,200	25.4×45	0.15	2.71	ELXQ161VSN122MQ45S			680	22×45	0.15	1.94	ELXQ221VSN681MP45S
	1,200	30×35	0.15	2.69	ELXQ161VSN122MR35S			680	22×50	0.15	1.99	ELXQ221VSN681MP50S
	1,200	30×40	0.15	2.77	ELXQ161VSN122MR40S		680	25.4×35	0.15	1.96	ELXQ221VSN681MQ35S	
	1,200	35×30	0.15	2.86	ELXQ161VSN122MA30S		680	30×35	0.15	2.02	ELXQ221VSN681MR35S	
	1,500	25.4×50	0.15	3.08	ELXQ161VSN152MQ50S		680	35×25	0.15	2.10	ELXQ221VSN681MA25S	
	1,500	30×45	0.15	3.17	ELXQ161VSN152MR45S		820	25.4×40	0.15	2.20	ELXQ221VSN821MQ40S	
	1,500	35×35	0.15	3.22	ELXQ161VSN152MA35S		820	25.4×45	0.15	2.24	ELXQ221VSN821MQ45S	
1,800	30×50	0.15	3.53	ELXQ161VSN182MR50S	820	30×40	0.15	2.29	ELXQ221VSN821MR40S			
1,800	35×40	0.15	3.66	ELXQ161VSN182MA40S	820	35×30	0.15	2.36	ELXQ221VSN821MA30S			
2,200	35×45	0.15	4.14	ELXQ161VSN222MA45S	1,000	25.4×50	0.15	2.51	ELXQ221VSN102MQ50S			
2,700	35×50	0.15	4.68	ELXQ161VSN272MA50S	1,000	30×45	0.15	2.59	ELXQ221VSN102MR45S			
180	330	22×25	0.15	1.21	ELXQ181VSN331MP25S	1,000	35×35	0.15	2.63	ELXQ221VSN102MA35S		
	470	22×30	0.15	1.52	ELXQ181VSN471MP30S	1,200	30×50	0.15	2.88	ELXQ221VSN122MR50S		
	470	25.4×25	0.15	1.52	ELXQ181VSN471MQ25S	1,200	35×40	0.15	2.98	ELXQ221VSN122MA40S		
	560	22×35	0.15	1.70	ELXQ181VSN561MP35S	1,500	35×45	0.15	3.41	ELXQ221VSN152MA45S		
	560	30×25	0.15	1.78	ELXQ181VSN561MR25S	1,800	35×50	0.15	3.82	ELXQ221VSN182MA50S		
	680	22×40	0.15	1.91	ELXQ181VSN681MP40S	250	220	22×25	0.15	1.01	ELXQ251VSN221MP25S	
	680	25.4×30	0.15	1.88	ELXQ181VSN681MQ30S		270	22×30	0.15	1.20	ELXQ251VSN271MP30S	
	820	22×45	0.15	1.99	ELXQ181VSN821MP45S		330	25.4×25	0.15	1.32	ELXQ251VSN331MQ25S	
	820	25.4×35	0.15	2.16	ELXQ181VSN821MQ35S		390	22×35	0.15	1.44	ELXQ251VSN391MP35S	
	820	30×30	0.15	2.17	ELXQ181VSN821MP30S		390	25.4×30	0.15	1.43	ELXQ251VSN391MQ30S	
	820	35×25	0.15	2.31	ELXQ181VSN821MA25S		390	30×25	0.15	1.51	ELXQ251VSN391MR25S	
	1,000	22×50	0.15	2.25	ELXQ181VSN102MP50S		470	22×40	0.15	1.62	ELXQ251VSN471MP40S	
	1,000	25.4×40	0.15	2.43	ELXQ181VSN102MQ40S		560	22×45	0.15	1.80	ELXQ251VSN561MP45S	
	1,000	25.4×45	0.15	2.47	ELXQ181VSN102MQ45S		560	22×50	0.15	1.84	ELXQ251VSN561MP50S	
	1,000	30×35	0.15	2.46	ELXQ181VSN102MR35S		560	25.4×35	0.15	1.78	ELXQ251VSN561MQ35S	
	1,200	25.4×50	0.15	2.75	ELXQ181VSN122MQ50S	560	30×30	0.15	1.83	ELXQ251VSN561MR30S		
	1,200	30×40	0.15	2.77	ELXQ181VSN122MR40S	560	35×25	0.15	1.91	ELXQ251VSN561MA25S		
	1,200	35×30	0.15	2.86	ELXQ181VSN122MA30S	680	25.4×40	0.15	2.00	ELXQ251VSN681MQ40S		
	1,500	30×45	0.15	3.17	ELXQ181VSN152MR45S	680	25.4×45	0.15	2.04	ELXQ251VSN681MQ45S		
	1,500	30×50	0.15	3.22	ELXQ181VSN152MR50S	680	30×35	0.15	2.06	ELXQ251VSN681MR35S		
1,500	35×35	0.15	3.22	ELXQ181VSN152MA35S	680	35×30	0.15	2.15	ELXQ251VSN681MA30S			
1,800	35×40	0.15	3.66	ELXQ181VSN182MA40S	820	25.4×50	0.15	2.28	ELXQ251VSN821MQ50S			
1,800	35×45	0.15	3.74	ELXQ181VSN182MA45S	820	30×40	0.15	2.33	ELXQ251VSN821MR40S			
2,200	35×50	0.15	4.22	ELXQ181VSN222MA50S	820	30×45	0.15	2.39	ELXQ251VSN821MR45S			
200	270	22×25	0.15	1.10	ELXQ201VSN271MP25S	820	35×35	0.15	2.38	ELXQ251VSN821MA35S		
	390	22×30	0.15	1.38	ELXQ201VSN391MP30S	1,000	30×50	0.15	2.68	ELXQ251VSN102MR50S		
	390	25.4×25	0.15	1.39	ELXQ201VSN391MQ25S	1,000	35×40	0.15	2.72	ELXQ251VSN102MA40S		
	470	22×35	0.15	1.55	ELXQ201VSN471MP35S	1,200	35×45	0.15	3.05	ELXQ251VSN122MA45S		
	560	22×40	0.15	1.73	ELXQ201VSN561MP40S	1,500	35×50	0.15	3.49	ELXQ251VSN152MA50S		
	560	25.4×30	0.15	1.71	ELXQ201VSN561MQ30S	315	150	22×25	0.15	0.80	ELXQ3B1VSN151MP25S	
	560	30×25	0.15	1.78	ELXQ201VSN561MR25S		180	22×30	0.15	0.92	ELXQ3B1VSN181MP30S	
	680	22×45	0.15	1.81	ELXQ201VSN681MP45S		180	25.4×25	0.15	0.94	ELXQ3B1VSN181MQ25S	
	680	25.4×35	0.15	1.87	ELXQ201VSN681MQ35S		220	22×35	0.15	1.04	ELXQ3B1VSN221MP35S	
	680	30×30	0.15	1.98	ELXQ201VSN681MR30S		220	30×25	0.15	1.17	ELXQ3B1VSN221MR25S	
	680	35×25	0.15	2.10	ELXQ201VSN681MA25S		270	22×40	0.15	1.18	ELXQ3B1VSN271MP40S	
	820	22×50	0.15	2.18	ELXQ201VSN821MP50S		270	25.4×30	0.15	1.19	ELXQ3B1VSN271MQ30S	
	820	25.4×40	0.15	2.09	ELXQ201VSN821MQ40S		330	22×45	0.15	1.33	ELXQ3B1VSN331MP45S	
	820	30×35	0.15	2.22	ELXQ201VSN821MR35S		330	25.4×35	0.15	1.37	ELXQ3B1VSN331MQ35S	
	1,000	25.4×45	0.15	2.35	ELXQ201VSN102MQ45S		330	30×30	0.15	1.40	ELXQ3B1VSN331MR30S	
	1,000	25.4×50	0.15	2.39	ELXQ201VSN102MQ50S	330	35×25	0.15	1.49	ELXQ3B1VSN331MA25S		
	1,000	30×40	0.15	2.53	ELXQ201VSN102MR40S	390	22×50	0.15	1.48	ELXQ3B1VSN391MP50S		
	1,000	35×30	0.15	2.61	ELXQ201VSN102MA30S	390	25.4×40	0.15	1.52	ELXQ3B1VSN391MQ40S		
	1,200	30×45	0.15	2.84	ELXQ201VSN122MR45S	470	25.4×45	0.15	1.70	ELXQ3B1VSN471MQ45S		

Product specifications in this catalog are subject to change without notice. Request our product specifications before purchase and/or use. Please use our products based on the information contained in this catalog and product specifications.



◆STANDARD RATINGS

WV (Vdc)	Cap (μF)	Case size φD×L(mm)	tan δ	Rated ripple current (Arms/105°C, 120Hz)	Part No.	WV (Vdc)	Cap (μF)	Case size φD×L(mm)	tan δ	Rated ripple current (Arms/105°C, 120Hz)	Part No.	
315	470	30×35	0.15	1.71	ELXQ3B1VSN471MR35S	400	470	30×45	0.15	1.81	ELXQ401VSN471MR45S	
	470	35×30	0.15	1.82	ELXQ3B1VSN471MA30S		470	30×50	0.15	1.84	ELXQ401VSN471MR50S	
	560	25.4×50	0.15	1.88	ELXQ3B1VSN561MQ50S		470	35×40	0.15	1.90	ELXQ401VSN471MA40S	
	560	30×40	0.15	1.92	ELXQ3B1VSN561MR40S		560	35×45	0.15	2.12	ELXQ401VSN561MA45S	
	560	30×45	0.15	1.97	ELXQ3B1VSN561MR45S		680	35×50	0.15	2.39	ELXQ401VSN681MA50S	
	560	35×35	0.15	2.00	ELXQ3B1VSN561MA35S		420	100	22×25	0.20	0.66	ELXQ421VSN101MP25S
	680	30×50	0.15	2.21	ELXQ3B1VSN681MR50S			120	22×30	0.20	0.75	ELXQ421VSN121MP30S
	680	35×40	0.15	2.29	ELXQ3B1VSN681MA40S			120	25.4×25	0.20	0.77	ELXQ421VSN121MQ25S
	820	35×45	0.15	2.57	ELXQ3B1VSN821MA45S			150	22×35	0.20	0.86	ELXQ421VSN151MP35S
	1,000	35×50	0.15	2.89	ELXQ3B1VSN102MA50S			180	22×40	0.20	0.96	ELXQ421VSN181MP40S
350	120	22×25	0.15	0.72	ELXQ351VSN121MP25S	180		22×45	0.20	0.98	ELXQ421VSN181MP45S	
	150	22×30	0.15	0.84	ELXQ351VSN151MP30S	180		25.4×30	0.20	0.97	ELXQ421VSN181MQ30S	
	180	25.4×25	0.15	0.94	ELXQ351VSN181MQ25S	180		25.4×35	0.20	1.01	ELXQ421VSN181MQ35S	
	220	22×35	0.15	1.04	ELXQ351VSN221MP35S	180		30×25	0.20	1.02	ELXQ421VSN181MR25S	
	220	22×40	0.15	1.06	ELXQ351VSN221MP40S	220		22×50	0.20	1.11	ELXQ421VSN221MP50S	
	220	25.4×30	0.15	1.07	ELXQ351VSN221MQ30S	220		25.4×40	0.20	1.14	ELXQ421VSN221MQ40S	
	220	30×25	0.15	1.13	ELXQ351VSN221MR25S	220		30×30	0.20	1.14	ELXQ421VSN221MR30S	
	270	22×45	0.15	1.20	ELXQ351VSN271MP45S	220		35×25	0.20	1.22	ELXQ421VSN221MA25S	
	270	25.4×35	0.15	1.24	ELXQ351VSN271MQ35S	270		25.4×45	0.20	1.29	ELXQ421VSN271MQ45S	
	270	30×30	0.15	1.27	ELXQ351VSN271MR30S	270		30×35	0.20	1.30	ELXQ421VSN271MR35S	
	270	35×25	0.15	1.35	ELXQ351VSN271MA25S	270		35×30	0.20	1.38	ELXQ421VSN271MA30S	
	330	22×50	0.15	1.36	ELXQ351VSN331MP50S	330		25.4×50	0.20	1.44	ELXQ421VSN331MQ50S	
	330	25.4×40	0.15	1.39	ELXQ351VSN331MQ40S	330		30×40	0.20	1.48	ELXQ421VSN331MR40S	
	330	30×35	0.15	1.43	ELXQ351VSN331MR35S	330		35×35	0.20	1.54	ELXQ421VSN331MA35S	
	390	25.4×45	0.15	1.55	ELXQ351VSN391MQ45S	390		30×45	0.20	1.64	ELXQ421VSN391MR45S	
	390	30×40	0.15	1.60	ELXQ351VSN391MR40S	390	35×40	0.20	1.73	ELXQ421VSN391MA40S		
	390	35×30	0.15	1.66	ELXQ351VSN391MA30S	470	30×50	0.20	1.84	ELXQ421VSN471MR50S		
	470	25.4×50	0.15	1.72	ELXQ351VSN471MQ50S	470	35×45	0.20	1.94	ELXQ421VSN471MA45S		
	470	30×45	0.15	1.81	ELXQ351VSN471MR45S	560	35×50	0.20	2.17	ELXQ421VSN561MA50S		
	470	35×35	0.15	1.83	ELXQ351VSN471MA35S	450	82	22×25	0.20	0.59	ELXQ451VSN820MP25S	
560	30×50	0.15	2.00	ELXQ351VSN561MR50S	100		22×30	0.20	0.69	ELXQ451VSN101MP30S		
560	35×40	0.15	2.07	ELXQ351VSN561MA40S	100		25.4×25	0.20	0.70	ELXQ451VSN101MQ25S		
680	35×45	0.15	2.34	ELXQ351VSN681MA45S	120		22×35	0.20	0.77	ELXQ451VSN121MP35S		
820	35×50	0.15	2.62	ELXQ351VSN821MA50S	150		22×40	0.20	0.88	ELXQ451VSN151MP40S		
400	100	22×25	0.15	0.66	ELXQ401VSN101MP25S		150	22×45	0.20	0.90	ELXQ451VSN151MP45S	
	120	22×30	0.15	0.75	ELXQ401VSN121MP30S		150	25.4×30	0.20	0.88	ELXQ451VSN151MQ30S	
	150	22×35	0.15	0.86	ELXQ401VSN151MP35S		150	25.4×35	0.20	0.92	ELXQ451VSN151MQ35S	
	150	25.4×25	0.15	0.86	ELXQ401VSN151MQ25S		150	30×25	0.20	0.93	ELXQ451VSN151MR25S	
	180	22×40	0.15	0.96	ELXQ401VSN181MP40S		180	22×50	0.20	1.01	ELXQ451VSN181MP50S	
	180	25.4×30	0.15	0.97	ELXQ401VSN181MQ30S		180	25.4×40	0.20	1.03	ELXQ451VSN181MQ40S	
	180	30×25	0.15	1.02	ELXQ401VSN181MR25S		180	30×30	0.20	1.03	ELXQ451VSN181MR30S	
	220	22×45	0.15	1.09	ELXQ401VSN221MP45S		180	35×25	0.20	1.10	ELXQ451VSN181MA25S	
	220	25.4×35	0.15	1.12	ELXQ401VSN221MQ35S		220	25.4×45	0.20	1.16	ELXQ451VSN221MQ45S	
	220	35×25	0.15	1.22	ELXQ401VSN221MA25S		220	30×35	0.20	1.17	ELXQ451VSN221MR35S	
	270	22×50	0.15	1.23	ELXQ401VSN271MP50S		220	35×30	0.20	1.24	ELXQ451VSN221MA30S	
	270	25.4×40	0.15	1.26	ELXQ401VSN271MQ40S		270	25.4×50	0.20	1.31	ELXQ451VSN271MQ50S	
	270	25.4×45	0.15	1.29	ELXQ401VSN271MQ45S		270	30×40	0.20	1.33	ELXQ451VSN271MR40S	
	270	30×30	0.15	1.27	ELXQ401VSN271MR30S		270	35×35	0.20	1.39	ELXQ451VSN271MA35S	
	330	25.4×50	0.15	1.44	ELXQ401VSN331MQ50S		330	30×45	0.20	1.51	ELXQ451VSN331MR45S	
	330	30×35	0.15	1.43	ELXQ401VSN331MR35S	390	30×50	0.20	1.67	ELXQ451VSN391MR50S		
	330	35×30	0.15	1.52	ELXQ401VSN331MA30S	390	35×40	0.20	1.73	ELXQ451VSN391MA40S		
	390	30×40	0.15	1.60	ELXQ401VSN391MR40S	390	35×45	0.20	1.77	ELXQ451VSN391MA45S		
	390	35×35	0.15	1.67	ELXQ401VSN391MA35S	470	35×50	0.20	1.98	ELXQ451VSN471MA50S		

◆RATED RIPPLE CURRENT MULTIPLIERS

●Frequency Multipliers

Frequency (Hz)	50	120	300	1k	10k	50k
160 to 250V _{dc}	0.81	1.00	1.17	1.32	1.45	1.50
315 to 450V _{dc}	0.77	1.00	1.16	1.30	1.41	1.43

The endurance of capacitors is reduced with internal heating produced by ripple current at the rate of halving the lifetime with every 5°C rise. When long life performance is required in actual use, the rms ripple current has to be reduced.

LXG Series

- Endurance with ripple current : 5,000 hours at 105°C
- Non solvent resistant type
- RoHS Compliant

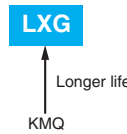

◆SPECIFICATIONS

Items	Characteristics
Category	
Temperature Range	-40 to +105°C
Rated Voltage Range	10 to 100V _{dc} (at 20°C, 120Hz)
Capacitance Tolerance	±20% (M)
Leakage Current	I=0.02CV or 3mA, whichever is smaller. Where, I : Max. leakage current (µA), C : Nominal capacitance (µF), V : Rated voltage (V) (at 20°C after 5 minutes)
Dissipation Factor (tanδ)	Rated voltage (V _{dc}) 10V 16V 25V 35V 50V 63V 80 & 100V tanδ (Max.) 0.60 0.45 0.30 0.25 0.20 0.15 0.15 (at 20°C, 120Hz)
Low Temperature Characteristics (Max. Impedance Ratio)	Capacitance change : Capacitance at the lowest operating temperature shall not be less than 70% of the 20°C value. Rated voltage (V _{dc}) 10V 16V 25V 35V 50V 63V 80 & 100V Z(-25°C)/Z(+20°C) 4 4 3 3 2 2 2 Z(-40°C)/Z(+20°C) 15 15 10 8 6 6 5 (at 120Hz)
Endurance	The following specifications shall be satisfied when the capacitors are restored to 20°C after subjected to DC voltage with rated ripple current is applied (the peak voltage shall not exceed the rated voltage) for 5,000 hours at 105°C. Capacitance change ≤±25% of the initial value D.F. (tanδ) ≤250% of the initial specified value Leakage current ≤The initial specified value
Shelf Life	The following specifications shall be satisfied when the capacitors are restored to 20°C after exposing them for 500 hours at 105°C without voltage applied. Before the measurement, the capacitor shall be preconditioned by applying voltage according to Item 4.1 of JIS C 5101-4. Capacitance change ≤±20% of the initial value D.F. (tanδ) ≤150% of the initial specified value Leakage current ≤The initial specified value

◆DIMENSIONS [mm]

- Terminal Code : VS (φ22 to φ35) : Standard

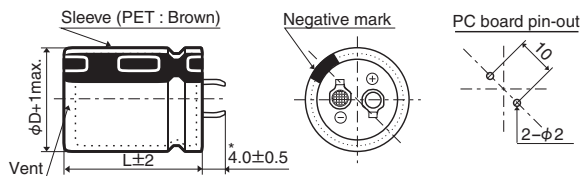

*φD=35mm : 3.5±0.5mm

The standard design has no plastic disc.

- Terminal Code : LI (φ35)

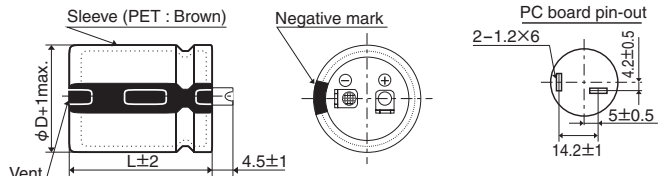

◆PART NUMBERING SYSTEM

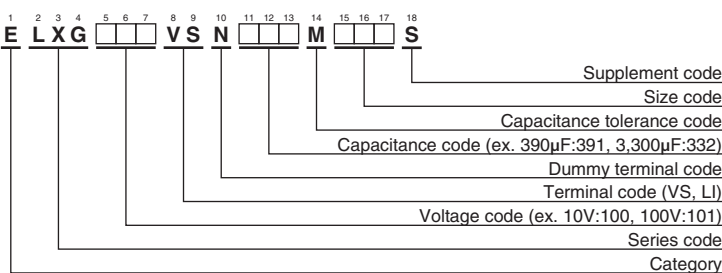

Please refer to "Product code guide (snap-in type)"

◆RATED RIPPLE CURRENT MULTIPLIERS

- Frequency Multipliers

Frequency (Hz)	50	120	300	1k	10k	50k
10 to 50V _{dc}	0.95	1.00	1.03	1.05	1.08	1.08
63 to 100V _{dc}	0.92	1.00	1.07	1.13	1.19	1.20

The endurance of capacitors is reduced with internal heating produced by ripple current at the rate of halving the lifetime with every 5°C rise. When long life performance is required in actual use, the rms ripple current has to be reduced.



◆STANDARD RATINGS

WV (Vdc)	Cap (μF)	Case size φD×L(mm)	tanδ	Rated ripple current (Arms/105°C,120Hz)	Part No.	WV (Vdc)	Cap (μF)	Case size φD×L(mm)	tanδ	Rated ripple current (Arms/105°C,120Hz)	Part No.	
10	6,800	22×25	0.60	1.30	ELXG100VSN682MP25S	35	5,600	25.4×35	0.25	1.98	ELXG350VSN562MQ35S	
	10,000	22×30	0.60	1.65	ELXG100VSN103MP30S		5,600	30×30	0.25	1.98	ELXG350VSN562MR30S	
	10,000	25.4×25	0.60	1.64	ELXG100VSN103MQ25S		5,600	35×25	0.25	2.03	ELXG350VSN562MA25S	
	12,000	22×35	0.60	1.85	ELXG100VSN123MP35S		6,800	22×50	0.25	2.26	ELXG350VSN682MP50S	
	12,000	25.4×30	0.60	1.85	ELXG100VSN123MQ30S		6,800	25.4×40	0.25	2.24	ELXG350VSN682MQ40S	
	12,000	30×25	0.60	1.89	ELXG100VSN123MR25S		8,200	25.4×50	0.25	2.57	ELXG350VSN822MQ50S	
	15,000	22×40	0.60	2.12	ELXG100VSN153MP40S		8,200	30×35	0.25	2.50	ELXG350VSN822MR35S	
	15,000	25.4×35	0.60	2.16	ELXG100VSN153MQ35S		8,200	35×30	0.25	2.55	ELXG350VSN822MA30S	
	18,000	22×50	0.60	2.45	ELXG100VSN183MP50S		10,000	30×40	0.25	2.86	ELXG350VSN103MR40S	
	18,000	25.4×40	0.60	2.43	ELXG100VSN183MQ40S		10,000	35×35	0.25	2.88	ELXG350VSN103MA35S	
	18,000	30×30	0.60	2.37	ELXG100VSN183MR30S		12,000	30×50	0.25	3.32	ELXG350VSN123MR50S	
	18,000	35×25	0.60	2.42	ELXG100VSN183MA25S		12,000	35×40	0.25	3.30	ELXG350VSN123MA40S	
	22,000	30×35	0.60	2.73	ELXG100VSN223MR35S		18,000	35×50	0.25	4.29	ELXG350VSN183MA50S	
	22,000	35×30	0.60	2.79	ELXG100VSN223MA30S		50	1,500	22×25	0.20	1.02	ELXG500VSN152MP25S
	27,000	25.4×50	0.60	3.11	ELXG100VSN273MQ50S			1,800	22×30	0.20	1.17	ELXG500VSN182MP30S
	27,000	30×40	0.60	3.13	ELXG100VSN273MR40S			1,800	25.4×25	0.20	1.17	ELXG500VSN182MQ25S
	33,000	35×35	0.60	3.49	ELXG100VSN333MA35S			2,200	22×35	0.20	1.33	ELXG500VSN222MP35S
	39,000	30×50	0.60	3.99	ELXG100VSN393MR50S			2,700	22×40	0.20	1.51	ELXG500VSN272MP40S
39,000	35×40	0.60	3.96	ELXG100VSN393MA40S	2,700	25.4×30		0.20	1.47	ELXG500VSN272MQ30S		
47,000	35×50	0.60	4.62	ELXG100VSN473MA50S	2,700	30×25		0.20	1.50	ELXG500VSN272MR25S		
16	5,600	22×25	0.45	1.44	ELXG160VSN562MP25S	3,300		25.4×35	0.20	1.70	ELXG500VSN332MQ35S	
	6,800	22×30	0.45	1.66	ELXG160VSN682MP30S	3,300		30×30	0.20	1.70	ELXG500VSN332MR30S	
	6,800	25.4×25	0.45	1.66	ELXG160VSN682MQ25S	3,300		35×25	0.20	1.74	ELXG500VSN332MA25S	
	8,200	22×35	0.45	1.87	ELXG160VSN822MP35S	3,900		22×50	0.20	1.91	ELXG500VSN392MP50S	
	10,000	22×40	0.45	2.12	ELXG160VSN103MP40S	3,900		25.4×40	0.20	1.89	ELXG500VSN392MQ40S	
	10,000	25.4×30	0.45	2.07	ELXG160VSN103MQ30S	4,700		30×35	0.20	2.11	ELXG500VSN472MR35S	
	10,000	30×25	0.45	2.11	ELXG160VSN103MR25S	4,700		35×30	0.20	2.16	ELXG500VSN472MA30S	
	12,000	25.4×35	0.45	2.37	ELXG160VSN123MQ35S	5,600		25.4×50	0.20	2.38	ELXG500VSN562MQ50S	
	12,000	30×30	0.45	2.37	ELXG160VSN123MR30S	5,600		30×40	0.20	2.39	ELXG500VSN562MR40S	
	12,000	35×25	0.45	2.42	ELXG160VSN123MA25S	5,600		35×35	0.20	2.41	ELXG500VSN562MA35S	
	15,000	22×50	0.45	2.74	ELXG160VSN153MP50S	6,800		30×50	0.20	2.79	ELXG500VSN682MR50S	
	15,000	25.4×40	0.45	2.71	ELXG160VSN153MQ40S	6,800	35×40	0.20	2.78	ELXG500VSN682MA40S		
	18,000	25.4×50	0.45	3.11	ELXG160VSN183MQ50S	10,000	35×50	0.20	3.57	ELXG500VSN103MA50S		
	18,000	30×35	0.45	3.02	ELXG160VSN183MR35S	63	1,000	22×25	0.15	1.10	ELXG630VSN102MP25S	
	18,000	35×30	0.45	3.09	ELXG160VSN183MA30S		1,200	22×30	0.15	1.15	ELXG630VSN122MP30S	
	22,000	30×40	0.45	3.46	ELXG160VSN223MR40S		1,200	25.4×25	0.15	1.15	ELXG630VSN122MQ25S	
	22,000	35×35	0.45	3.49	ELXG160VSN223MA35S		1,500	22×35	0.15	1.32	ELXG630VSN152MP35S	
	27,000	30×50	0.45	4.07	ELXG160VSN273MR50S		1,800	22×40	0.15	1.49	ELXG630VSN182MP40S	
27,000	35×40	0.45	4.04	ELXG160VSN273MA40S	1,800		25.4×30	0.15	1.45	ELXG630VSN182MQ30S		
39,000	35×50	0.45	5.16	ELXG160VSN393MA50S	1,800		30×25	0.15	1.48	ELXG630VSN182MR25S		
25	3,900	22×25	0.30	1.31	ELXG250VSN392MP25S		2,200	25.4×35	0.15	1.67	ELXG630VSN222MQ35S	
	4,700	22×30	0.30	1.51	ELXG250VSN472MP30S		2,200	30×30	0.15	1.68	ELXG630VSN222MR30S	
	4,700	25.4×25	0.30	1.51	ELXG250VSN472MQ25S		2,200	35×25	0.15	1.71	ELXG630VSN222MA25S	
	5,600	22×35	0.30	1.70	ELXG250VSN562MP35S		2,700	22×50	0.15	1.92	ELXG630VSN272MP50S	
	6,800	22×40	0.30	1.92	ELXG250VSN682MP40S		2,700	25.4×40	0.15	1.90	ELXG630VSN272MQ40S	
	6,800	25.4×30	0.30	1.87	ELXG250VSN682MQ30S		2,700	30×35	0.15	1.93	ELXG630VSN272MR35S	
	6,800	30×25	0.30	1.90	ELXG250VSN682MR25S		3,300	25.4×50	0.15	2.20	ELXG630VSN332MQ50S	
	8,200	25.4×35	0.30	2.14	ELXG250VSN822MQ35S		3,300	35×30	0.15	2.18	ELXG630VSN332MA30S	
	8,200	30×30	0.30	2.15	ELXG250VSN822MR30S		3,900	30×40	0.15	2.41	ELXG630VSN392MR40S	
	8,200	35×25	0.30	2.19	ELXG250VSN822MA25S		3,900	35×35	0.15	2.43	ELXG630VSN392MA35S	
	10,000	22×50	0.30	2.45	ELXG250VSN103MP50S		4,700	30×50	0.15	2.80	ELXG630VSN472MR50S	
	10,000	25.4×40	0.30	2.43	ELXG250VSN103MQ40S	4,700	35×40	0.15	2.78	ELXG630VSN472MA40S		
	12,000	25.4×50	0.30	2.78	ELXG250VSN123MQ50S	6,800	35×50	0.15	3.55	ELXG630VSN682MA50S		
	12,000	30×35	0.30	2.70	ELXG250VSN123MR35S	80	680	22×25	0.15	0.97	ELXG800VSN681MP25S	
	12,000	35×30	0.30	2.76	ELXG250VSN123MA30S		820	22×30	0.15	1.12	ELXG800VSN821MP30S	
	15,000	30×40	0.30	3.13	ELXG250VSN153MR40S		1,000	22×35	0.15	1.27	ELXG800VSN102MP35S	
	15,000	35×35	0.30	3.16	ELXG250VSN153MA35S		1,000	25.4×25	0.15	1.23	ELXG800VSN102MQ25S	
	18,000	30×50	0.30	3.64	ELXG250VSN183MR50S		1,200	22×40	0.15	1.42	ELXG800VSN122MP40S	
18,000	35×40	0.30	3.61	ELXG250VSN183MA40S	1,200		25.4×30	0.15	1.39	ELXG800VSN122MQ30S		
27,000	35×50	0.30	4.70	ELXG250VSN273MA50S	1,200		30×25	0.15	1.41	ELXG800VSN122MR25S		
35	2,200	22×25	0.25	1.10	ELXG350VSN222MP25S		1,500	25.4×35	0.15	1.62	ELXG800VSN152MQ35S	
	3,300	22×30	0.25	1.42	ELXG350VSN332MP30S		1,800	22×50	0.15	1.84	ELXG800VSN182MP50S	
	3,300	25.4×25	0.25	1.41	ELXG350VSN332MQ25S		1,800	25.4×40	0.15	1.82	ELXG800VSN182MQ40S	
	3,900	22×35	0.25	1.58	ELXG350VSN392MP35S		1,800	30×30	0.15	1.78	ELXG800VSN182MR30S	
	3,900	25.4×30	0.25	1.58	ELXG350VSN392MQ30S		1,800	35×25	0.15	1.82	ELXG800VSN182MA25S	
	4,700	22×40	0.25	1.78	ELXG350VSN472MP40S		2,200	25.4×50	0.15	2.11	ELXG800VSN222MQ50S	
	4,700	30×25	0.25	1.77	ELXG350VSN472MR25S		2,200	30×35	0.15	2.05	ELXG800VSN222MR35S	

Product specifications in this catalog are subject to change without notice. Request our product specifications before purchase and/or use. Please use our products based on the information contained in this catalog and product specifications.

◆STANDARD RATINGS

WV (Vdc)	Cap (μF)	Case size φD×L(mm)	tanδ	Rated ripple current (Arms/105°C, 120Hz)	Part No.	WV (Vdc)	Cap (μF)	Case size φD×L(mm)	tanδ	Rated ripple current (Arms/105°C, 120Hz)	Part No.
80	2,200	35 × 30	0.15	2.09	ELXG800VSN222MA30S	100	1,000	25.4 × 35	0.15	1.41	ELXG101VSN102MQ35S
	2,700	30 × 40	0.15	2.35	ELXG800VSN272MR40S		1,000	30 × 30	0.15	1.42	ELXG101VSN102MR30S
	2,700	35 × 35	0.15	2.37	ELXG800VSN272MA35S		1,000	35 × 25	0.15	1.45	ELXG101VSN102MA25S
	3,300	30 × 50	0.15	2.75	ELXG800VSN332MR50S		1,200	22 × 50	0.15	1.60	ELXG101VSN122MP50S
	3,300	35 × 40	0.15	2.73	ELXG800VSN332MA40S		1,200	25.4 × 40	0.15	1.59	ELXG101VSN122MQ40S
	4,700	35 × 50	0.15	3.46	ELXG800VSN472MA50S		1,200	30 × 35	0.15	1.61	ELXG101VSN122MR35S
100	390	22 × 25	0.15	0.78	ELXG101VSN391MP25S		1,500	25.4 × 50	0.15	1.86	ELXG101VSN152MQ50S
	560	22 × 30	0.15	0.99	ELXG101VSN561MP30S		1,500	30 × 40	0.15	1.87	ELXG101VSN152MR40S
	560	25.4 × 25	0.15	0.98	ELXG101VSN561MQ25S		1,500	35 × 30	0.15	1.85	ELXG101VSN152MA30S
	680	22 × 35	0.15	1.12	ELXG101VSN681MP35S		1,800	35 × 35	0.15	2.07	ELXG101VSN182MA35S
	820	22 × 40	0.15	1.26	ELXG101VSN821MP40S		2,200	30 × 50	0.15	2.40	ELXG101VSN222MR50S
	820	25.4 × 30	0.15	1.23	ELXG101VSN821MQ30S		2,200	35 × 40	0.15	2.39	ELXG101VSN222MA40S
	820	30 × 25	0.15	1.25	ELXG101VSN821MR25S		2,700	35 × 50	0.15	2.81	ELXG101VSN272MA50S

◆MAXIMUM IMPEDANCE [mΩ/20°C, 30kHz]

Case size φD×L(mm)	V _{dc}		
	10 to 63	80	100
22×25	120	150	
22×30	100	120	
22×35	80	95	
22×40	70	80	
22×50	50	60	
25.4×25	90	110	
25.4×30	70	85	
25.4×35	60	70	
25.4×40	50	60	
25.4×50	40	45	
30×25	70	80	
30×30	50	60	
30×35	40	50	
30×40	35	40	
30×50	25	30	
35×25	65	70	
35×30	45	50	
35×35	38	40	
35×40	30	30	
35×50	23	25	



LARGE CAPACITANCE ALUMINUM ELECTROLYTIC CAPACITORS Overvoltage resistant design, 105°C

CHA Series

- Doesn't spark with DC over voltage
- Downsized from current KLG series
- Endurance with ripple current : 2,000 hours at 105°C
- Non solvent resistant type
- RoHS Compliant

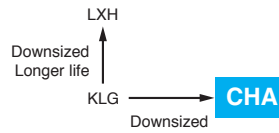

◆ SPECIFICATIONS

Items	Characteristics	
Category	-25 to +105°C	
Temperature Range		
Rated Voltage Range	200 to 450V _{dc}	
Capacitance Tolerance	±20% (M) (at 20°C, 120Hz)	
Leakage Current	I ≤ 3√CV (at 20°C after 5 minutes) Where, I : Max. leakage current (µA), C : Nominal capacitance (µF), V : Rated voltage (V _{dc})	
Dissipation Factor (tanδ)	200V _{dc} : 0.15 max. (0.20 max. for φD=35mm) (at 20°C, 120Hz) 400V _{dc} : 0.15 max.	
Low Temperature Characteristics (Max.Impedance Ratio)	Rated Voltage (V _{dc})	200 to 450V
	Z(-25°C) / Z(+20°C)	4 (at 120Hz)
ESL	50nH max. (at 20°C, 1MHz)	
Endurance	The following specifications shall be satisfied when the capacitors are restored to 20°C after subjected to DC voltage with the rated ripple current is applied (the peak voltage shall not exceed the rated voltage) for 2,000 hours at 105°C.	
	Capacitance change	≤ ±20% of the initial value
	D.F. (tanδ)	≤ 200% of the initial specified value
	Leakage current	≤ The initial specified value
Shelf Life	The following specifications shall be satisfied when the capacitors are restored to 20°C after exposing them for 1,000 hours at 105°C without voltage applied. Before the measurement, the capacitor shall be preconditioned by applying voltage according to Item 4.1 of JIS C 5101-4.	
	Capacitance change	≤ ±15% of the initial value
	D.F. (tanδ)	≤ 150% of the initial specified value
	Leakage current	≤ The initial specified value

◆ DIMENSIONS [mm]

- Terminal Code : VS (φ22 to φ35)

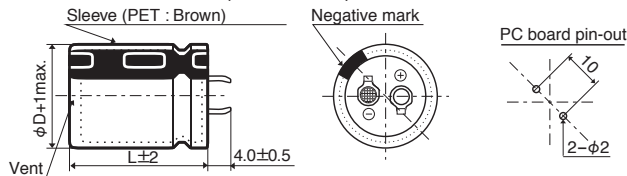

The standard design has no plastic disc.

◆ PART NUMBERING SYSTEM

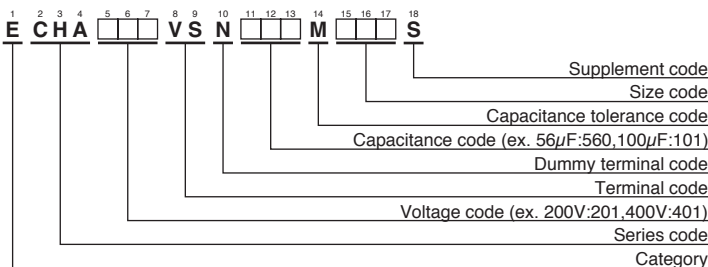

Please refer to "Product code guide (snap-in type)"

◆ RATED RIPPLE CURRENT MULTIPLIERS

- Frequency Multipliers

Frequency (Hz)	50	120	300	1k	10k	50k
200 to 450V _{dc}	0.77	1.00	1.16	1.30	1.41	1.43

The endurance of capacitors is reduced with internal heating produced by ripple current at the rate of halving the lifetime with every 5°C rise. When long life performance is required in actual use, the rms ripple current has to be reduced.

◆STANDARD RATINGS

WV (Vdc)	Cap (μF)	Case size φD×L(mm)	tanδ	Rated ripple current (Arms/105°C,120Hz)	Part No.
200	180	22×20	0.15	0.82	ECHA201VSN181MP20S
	220	22×20	0.15	0.90	ECHA201VSN221MP20S
	270	22×25	0.15	1.02	ECHA201VSN271MP25S
	330	22×30	0.15	1.20	ECHA201VSN331MP30S
	330	25.4×25	0.15	1.20	ECHA201VSN331MQ25S
	390	22×30	0.15	1.35	ECHA201VSN391MP30S
	390	25.4×25	0.15	1.35	ECHA201VSN391MQ25S
	470	22×35	0.15	1.45	ECHA201VSN471MP35S
	470	25.4×30	0.15	1.45	ECHA201VSN471MQ30S
	470	30×25	0.15	1.47	ECHA201VSN471MR25S
	560	22×40	0.15	1.62	ECHA201VSN561MP40S
	560	25.4×30	0.15	1.60	ECHA201VSN561MQ30S
	560	30×25	0.15	1.60	ECHA201VSN561MR25S
	680	25.4×35	0.15	1.82	ECHA201VSN681MQ35S
	680	30×30	0.15	1.81	ECHA201VSN681MR30S
	680	35×25	0.20	1.86	ECHA201VSN681MA25S
	820	25.4×45	0.15	2.11	ECHA201VSN821MQ45S
	820	30×35	0.15	2.11	ECHA201VSN821MR35S
	820	35×25	0.20	2.11	ECHA201VSN821MA25S
	250	1,000	30×35	0.15	2.40
1,000		35×30	0.20	2.40	ECHA201VSN102MA30S
1,200		30×45	0.15	2.69	ECHA201VSN122MR45S
1,200		35×35	0.20	2.65	ECHA201VSN122MA35S
120		22×20	0.15	0.68	ECHA251VSN121MP20S
180		22×25	0.15	0.87	ECHA251VSN181MP25S
180		25.4×20	0.15	0.93	ECHA251VSN181MQ20S
220		22×30	0.15	1.00	ECHA251VSN221MP30S
270		22×35	0.15	1.14	ECHA251VSN271MP35S
270		25.4×25	0.15	1.13	ECHA251VSN271MQ25S
270		30×20	0.15	1.25	ECHA251VSN271MR20S
330		22×40	0.15	1.28	ECHA251VSN331MP40S
330		25.4×30	0.15	1.29	ECHA251VSN331MQ30S
390		22×45	0.15	1.42	ECHA251VSN391MP45S
390		25.4×35	0.15	1.46	ECHA251VSN391MQ35S
390		30×25	0.15	1.52	ECHA251VSN391MR25S
390		35×20	0.20	1.62	ECHA251VSN391MA20S
470		25.4×40	0.15	1.64	ECHA251VSN471MQ40S
470		30×30	0.15	1.67	ECHA251VSN471MR30S
560		25.4×45	0.15	1.82	ECHA251VSN561MQ45S
560	30×35	0.15	1.87	ECHA251VSN561MR35S	
560	35×25	0.20	1.99	ECHA251VSN561MA25S	
250	680	30×40	0.15	2.12	ECHA251VSN681MR40S
	680	35×30	0.20	2.19	ECHA251VSN681MA30S
	820	30×45	0.15	2.39	ECHA251VSN821MR45S
	820	35×35	0.20	2.42	ECHA251VSN821MA35S
	56	22×20	0.15	0.45	ECHA401VSN560MP20S
	68	22×20	0.15	0.51	ECHA401VSN680MP20S
	82	22×25	0.15	0.58	ECHA401VSN820MP25S
	100	22×25	0.15	0.66	ECHA401VSN101MP25S
	100	25.4×25	0.15	0.66	ECHA401VSN101MQ25S
	120	22×30	0.15	0.76	ECHA401VSN121MP30S
120	25.4×25	0.15	0.76	ECHA401VSN121MQ25S	
150	22×35	0.15	0.85	ECHA401VSN151MP35S	
150	25.4×30	0.15	0.85	ECHA401VSN151MQ30S	
150	30×25	0.15	0.85	ECHA401VSN151MR25S	
180	22×40	0.15	0.94	ECHA401VSN181MP40S	
180	25.4×35	0.15	0.95	ECHA401VSN181MQ35S	
180	30×25	0.15	0.95	ECHA401VSN181MR25S	
220	25.4×35	0.15	1.24	ECHA401VSN221MQ35S	
220	30×30	0.15	1.24	ECHA401VSN221MR30S	
220	35×25	0.15	1.24	ECHA401VSN221MA25S	
270	25.4×45	0.15	1.30	ECHA401VSN271MQ45S	
270	30×35	0.15	1.30	ECHA401VSN271MR35S	
270	35×25	0.15	1.30	ECHA401VSN271MA25S	
330	30×35	0.15	1.45	ECHA401VSN331MR35S	
330	30×40	0.15	1.47	ECHA401VSN331MR40S	
330	35×30	0.15	1.47	ECHA401VSN331MA30S	
250	82	25.4×25	0.20	0.61	ECHA451VSN820MQ25S
	120	25.4×30	0.20	0.76	ECHA451VSN121MQ30S
	120	30×25	0.20	0.77	ECHA451VSN121MR25S
	150	25.4×35	0.20	0.88	ECHA451VSN151MQ35S
	180	25.4×40	0.20	0.99	ECHA451VSN181MQ40S
	180	30×30	0.20	0.97	ECHA451VSN181MR30S
	180	30×35	0.20	1.00	ECHA451VSN181MR35S
	220	30×35	0.20	1.30	ECHA451VSN221MR35S
	220	35×25	0.20	1.20	ECHA451VSN221MA25S
	270	30×40	0.20	1.28	ECHA451VSN271MR40S
270	35×30	0.20	1.30	ECHA451VSN271MA30S	
330	35×35	0.20	1.40	ECHA451VSN331MA35S	
390	35×40	0.20	1.60	ECHA451VSN391MA40S	
420	35×50	0.20	1.56	ECHA451VSN421MA50S	

◆DC OVERVOLTAGE TEST CONDITIONS

The vent will operate and the capacitor shall become an open circuit without burning materials when the following test DC voltage is applied.

●Test DC voltage

Rated Voltage	Nominal Capacitance	Current Limit	Test Voltage
200V _{dc}	<330μF	4A	300/375V _{dc}
	330μF ≤ C < 470μF	5A	
	≥ 470μF	7A	
250V _{dc}	<330μF	4A	350/450V _{dc}
	330μF ≤ C < 470μF	5A	
	≥ 470μF	7A	
400V _{dc}	<100μF	2A	500/600V _{dc}
	100μF ≤ C < 220μF	4A	
	≥ 220μF	7A	
450V _{dc}	<100μF	2A	550/675V _{dc}
	100μF ≤ C < 220μF	4A	
	≥ 220μF	7A	

●Test Circuit

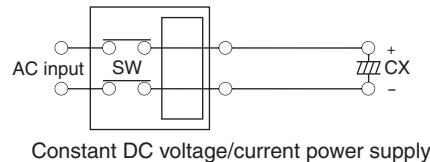

LXH Series

- Doesn't spark with DC over voltage
- Same case sizes of KMH
- Endurance with ripple current : 5,000 hours at 105°C
- Non solvent resistant type
- RoHS Compliant

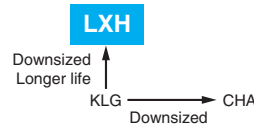

◆ SPECIFICATIONS

Items	Characteristics						
Category							
Temperature Range	-25 to +105°C						
Rated Voltage	200 & 400V _{dc}						
Capacitance Tolerance	±20% (M) (at 20°C, 120Hz)						
Leakage Current	I=0.02CV or 3mA, whichever is smaller. Where, I : Max. leakage current (µA), C : Nominal capacitance (µF), V : Rated voltage (V) (at 20°C after 5 minutes)						
Dissipation Factor (tanδ)	0.15 max. (at 20°C, 120Hz)						
Low Temperature Characteristics	Z(-25°C) / Z(+20°C) ≤ 4 (at 120Hz)						
ESL	50nH max. (at 20°C, 1MHz)						
DC Overvoltage Test	When an excessive DC voltage is applied to the capacitors under the test conditions on next page, the vent shall operate and then the capacitors shall become open-circuit without burning materials.						
Endurance	The following specifications shall be satisfied when the capacitors are restored to 20°C after subjected to DC voltage with the rated ripple current is applied (the peak voltage shall not exceed the rated voltage) for 5,000 or 3,000 hours at 105°C						
	<table border="1"> <tr> <td>Capacitance change</td> <td>≤ ±20% of the initial value</td> </tr> <tr> <td>D.F. (tanδ)</td> <td>≤ 200% of the initial specified value</td> </tr> <tr> <td>Leakage current</td> <td>≤ The initial specified value</td> </tr> </table>	Capacitance change	≤ ±20% of the initial value	D.F. (tanδ)	≤ 200% of the initial specified value	Leakage current	≤ The initial specified value
Capacitance change	≤ ±20% of the initial value						
D.F. (tanδ)	≤ 200% of the initial specified value						
Leakage current	≤ The initial specified value						
Shelf Life	The following specifications shall be satisfied when the capacitors are restored to 20°C after exposing them for 1,000 hours at 105°C without voltage applied. Before the measurement, the capacitor shall be preconditioned by applying voltage according to Item 4.1 of JIS C 5101-4.						
	<table border="1"> <tr> <td>Capacitance change</td> <td>≤ ±15% of the initial value</td> </tr> <tr> <td>D.F. (tanδ)</td> <td>≤ 150% of the initial specified value</td> </tr> <tr> <td>Leakage current</td> <td>≤ The initial specified value</td> </tr> </table>	Capacitance change	≤ ±15% of the initial value	D.F. (tanδ)	≤ 150% of the initial specified value	Leakage current	≤ The initial specified value
Capacitance change	≤ ±15% of the initial value						
D.F. (tanδ)	≤ 150% of the initial specified value						
Leakage current	≤ The initial specified value						

◆ DIMENSIONS [mm]

- Terminal Code : VS (φ22 to φ35)

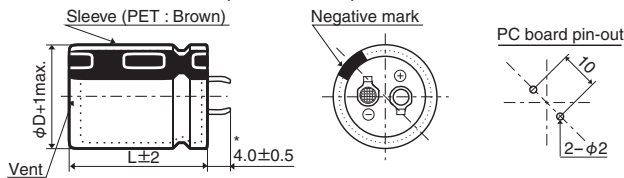

* φD=35mm : 3.5±0.5mm

The standard design has no plastic disc.

◆ PART NUMBERING SYSTEM

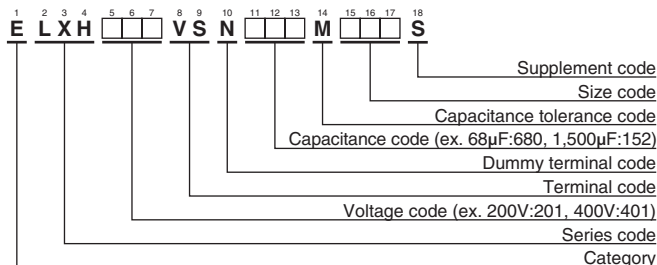

Please refer to "Product code guide (snap-in type)"

◆ RATED RIPPLE CURRENT MULTIPLIERS

- Frequency Multipliers

Frequency (Hz)	50	120	300	1k	10k	50k
200V _{dc}	0.81	1.00	1.17	1.32	1.45	1.50
400V _{dc}	0.77	1.00	1.16	1.30	1.41	1.43

The endurance of capacitors is reduced with internal heating produced by ripple current at the rate of halving the lifetime with every 5°C rise. When long life performance is required in actual use, the rms ripple current has to be reduced.

◆STANDARD RATINGS

WV (Vdc)	Cap (μF)	Case size φD×L(mm)	tan δ	Rated ripple current (Arms/105°C,120Hz)		Part No.
				5,000 hours	3,000 hours	
200	270	22×25	0.15	0.45	0.87	ELXH201VSN271MP25S
	330	22×30	0.15	0.62	1.20	ELXH201VSN331MP30S
	330	25.4×25	0.15	0.62	1.21	ELXH201VSN331MQ25S
	390	22×35	0.15	0.67	1.31	ELXH201VSN391MP35S
	390	25.4×30	0.15	0.66	1.28	ELXH201VSN391MQ30S
	470	22×40	0.15	0.72	1.40	ELXH201VSN471MP40S
	470	25.4×30	0.15	0.72	1.41	ELXH201VSN471MQ30S
	470	30×25	0.15	0.77	1.50	ELXH201VSN471MR25S
	560	22×45	0.15	0.80	1.56	ELXH201VSN561MP45S
	560	25.4×35	0.15	0.78	1.53	ELXH201VSN561MQ35S
	560	30×30	0.15	0.81	1.57	ELXH201VSN561MR30S
	680	22×50	0.15	0.89	1.74	ELXH201VSN681MP50S
	680	25.4×40	0.15	0.89	1.74	ELXH201VSN681MQ40S
	680	30×30	0.15	0.89	1.74	ELXH201VSN681MR30S
	680	35×25	0.15	0.88	1.72	ELXH201VSN681MA25S
	820	25.4×50	0.15	1.05	2.04	ELXH201VSN821MQ50S
	820	30×35	0.15	1.03	2.00	ELXH201VSN821MR35S
	820	35×30	0.15	1.05	2.04	ELXH201VSN821MA30S
	1,000	30×45	0.15	1.18	2.30	ELXH201VSN102MR45S
	1,000	35×35	0.15	1.18	2.30	ELXH201VSN102MA35S
1,200	30×50	0.15	1.33	2.60	ELXH201VSN122MR50S	
1,200	35×40	0.15	1.36	2.65	ELXH201VSN122MA40S	
1,500	35×45	0.15	1.57	3.08	ELXH201VSN152MA45S	
400	68	22×25	0.15	0.26	0.51	ELXH401VSN680MP25S
	68	25.4×20	0.15	0.24	0.46	ELXH401VSN680MQ20S
	82	22×30	0.15	0.30	0.58	ELXH401VSN820MP30S
	82	25.4×25	0.15	0.30	0.58	ELXH401VSN820MQ25S
	100	22×35	0.15	0.34	0.66	ELXH401VSN101MP35S
	100	25.4×30	0.15	0.34	0.66	ELXH401VSN101MQ30S
	120	22×40	0.15	0.37	0.72	ELXH401VSN121MP40S
	120	25.4×30	0.15	0.37	0.72	ELXH401VSN121MQ30S
	120	30×25	0.15	0.39	0.76	ELXH401VSN121MR25S
	150	22×45	0.15	0.42	0.82	ELXH401VSN151MP45S
	150	25.4×35	0.15	0.43	0.84	ELXH401VSN151MQ35S
	150	30×30	0.15	0.43	0.84	ELXH401VSN151MR30S
	180	22×50	0.15	0.49	0.95	ELXH401VSN181MP50S
	180	25.4×40	0.15	0.48	0.94	ELXH401VSN181MQ40S
	180	30×30	0.15	0.47	0.92	ELXH401VSN181MR30S
	180	35×25	0.15	0.48	0.94	ELXH401VSN181MA25S
	220	25.4×45	0.15	0.55	1.07	ELXH401VSN221MQ45S
	220	30×35	0.15	0.54	1.06	ELXH401VSN221MR35S
	220	35×30	0.15	0.55	1.08	ELXH401VSN221MA30S
	270	25.4×50	0.15	0.62	1.21	ELXH401VSN271MQ50S
	270	30×40	0.15	0.62	1.21	ELXH401VSN271MR40S
	270	35×30	0.15	0.59	1.15	ELXH401VSN271MA30S
	330	30×45	0.15	0.71	1.39	ELXH401VSN331MR45S
	330	35×35	0.15	0.69	1.35	ELXH401VSN331MA35S
	390	30×50	0.15	0.80	1.55	ELXH401VSN391MR50S
	390	35×40	0.15	0.79	1.54	ELXH401VSN391MA40S
	470	35×45	0.15	0.89	1.74	ELXH401VSN471MA45S

◆DC OVERVOLTAGE TEST CONDITIONS

The vent will operate and the capacitor shall become an open circuit without burning materials when the following test DC voltage is applied.

● Test DC voltage

Rated Voltage	Capacitance	Current limit	Test DC voltage
200V _{dc}	<330μF	4A	300/375V _{dc}
	330≤C<470μF	5A	
	≥470μF	7A	
400V _{dc}	<100μF	2A	500/600V _{dc}
	100≤C<220μF	4A	
	≥220μF	7A	

● Test Circuit

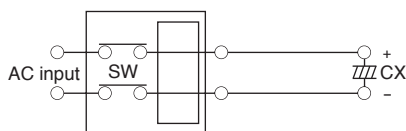

Constant DC voltage/current power supply

KMV Series

- For frequently change of regenerative voltage from AC servo amplifier and inverter control
- Ideal use to power supply, specially power source with turn on and off frequently and highly voltage fluctuation
- Improved the resistance for charge and discharge from same dimension of KMQ series
- Endurance with ripple current : 3,000 hours at 105°C
- Rated voltage range : 350 to 450Vdc, Capacitance 82 to 1,200μF
- Non Solvent resistant type
- RoHS Compliant



◆ SPECIFICATIONS

Items	Characteristics	
Category	Temperature Range	
Temperature Range	-25 to +105°C	
Rated Voltage Range	350 to 450V _{dc}	
Capacitance Tolerance	±20% (M) (at 20°C, 120Hz)	
Leakage Current	$I \leq 3\sqrt{CV}$ Where, I : Max. leakage current (μA), C : Nominal capacitance (μF), V : Rated voltage (V) (at 20°C after 5 minutes)	
Dissipation Factor (tanδ)	Rated voltage (V _{dc})	350 & 400V 420 & 450V
	tanδ (Max.)	0.15 0.20 (at 20°C, 120Hz)
Low Temperature Characteristics (Max. Impedance Ratio)	Rated voltage (V _{dc})	350 to 450V
	Z(-25°C)/Z(+20°C)	8 (at 120Hz)
Charge and Discharge	The following specifications shall be satisfied when the capacitors are restored to 20°C after subjected to charge and discharge test with the voltage waveform shown below at room temperature (15 to 35°C).	
	Capacitance change	≤ ±20% of the initial value
	D.F. (tanδ)	≤ 200% of the initial specified value
	Leakage current	≤ The initial specified value
	Frequency	6Hz
	Number of cycles	50 million times
	Voltage waveform	
Endurance	The following specifications shall be satisfied when the capacitors are restored to 20°C after subjected to DC voltage with the rated ripple current is applied (the peak voltage shall not exceed the rated voltage) for 3,000 hours at 105°C.	
	Capacitance change	≤ ±20% of the initial value
	D.F. (tanδ)	≤ 200% of the initial specified value
	Leakage current	≤ The initial specified value
Shelf Life	The following specifications shall be satisfied when the capacitors are restored to 20°C after exposing them for 1,000 hours at 105°C without voltage applied. Before the measurement, the capacitor shall be preconditioned by applying voltage according to Item 4.1 of JIS C 5101-4.	
	Capacitance change	≤ ±15% of the initial value
	D.F. (tanδ)	≤ 150% of the initial specified value
	Leakage current	≤ The initial specified value

*Please consult with us about charge and discharge conditions.

◆ DIMENSIONS [mm]

● Terminal Code : VS (φ22 to φ35) : Standard

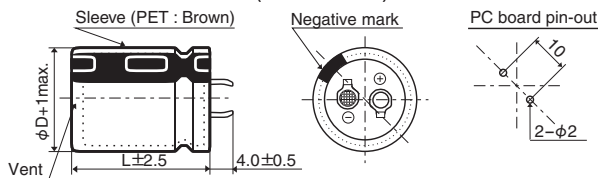

● Terminal Code : LI (φ35)

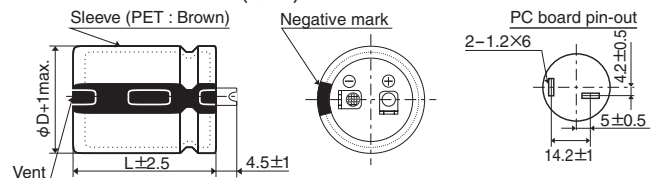

No plastic disk is the standard design.

KMV Series

◆PART NUMBERING SYSTEM

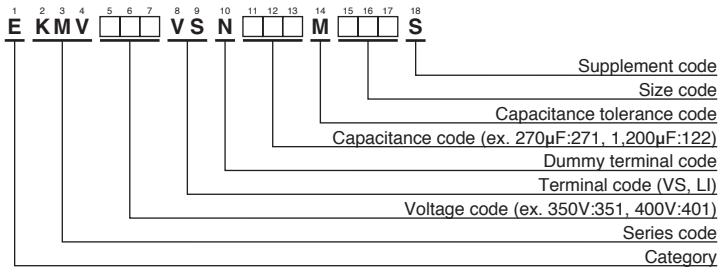

Please refer to "Product code guide (snap-in type)"

◆STANDARD RATINGS

WV (Vdc)	Cap (μF)	Case size φD×L(mm)	Rated ripple current (Arms/105°C,120Hz)	Max. charge current and Max. discharge current (Arms/ 6Hz)	Part No.
350	120	22×25	0.74	0.42	EKMV351VSN121MP25S
	150	22×30	0.87	0.49	EKMV351VSN151MP30S
	180	25.4×25	0.92	0.54	EKMV351VSN181MQ25S
	220	22×35	1.08	0.60	EKMV351VSN221MP35S
	220	22×40	1.10	0.62	EKMV351VSN221MP40S
	220	25.4×30	1.05	0.61	EKMV351VSN221MQ30S
	270	22×45	1.24	0.71	EKMV351VSN271MP45S
	270	25.4×35	1.21	0.70	EKMV351VSN271MQ35S
	270	30×25	1.15	0.68	EKMV351VSN271MR25S
	330	22×50	1.41	0.80	EKMV351VSN331MP50S
	330	25.4×40	1.37	0.80	EKMV351VSN331MQ40S
	330	30×30	1.29	0.77	EKMV351VSN331MR30S
	330	35×25	1.31	0.78	EKMV351VSN331MA25S
	390	25.4×45	1.51	0.89	EKMV351VSN391MQ45S
	390	30×35	1.44	0.88	EKMV351VSN391MR35S
	470	25.4×50	1.69	0.99	EKMV351VSN471MQ50S
	470	30×40	1.62	1.00	EKMV351VSN471MR40S
	470	35×30	1.61	0.97	EKMV351VSN471MA30S
	560	30×45	1.82	1.12	EKMV351VSN561MR45S
	560	35×35	1.77	1.08	EKMV351VSN561MA35S
680	30×50	2.04	1.27	EKMV351VSN681MR50S	
680	35×40	2.02	1.25	EKMV351VSN681MA40S	
820	35×45	2.27	1.41	EKMV351VSN821MA45S	
820	35×50	2.32	1.46	EKMV351VSN821MA50S	
1,200	35×60	2.88	1.84	EKMV351VSN122MA60S	
400	100	22×25	0.69	0.38	EKMV401VSN101MP25S
	120	22×30	0.79	0.44	EKMV401VSN121MP30S
	150	25.4×25	0.87	0.49	EKMV401VSN151MQ25S
	180	22×35	0.99	0.55	EKMV401VSN181MP35S
	180	22×40	1.01	0.56	EKMV401VSN181MP40S
	180	25.4×30	0.98	0.55	EKMV401VSN181MQ30S
	220	22×45	1.14	0.64	EKMV401VSN221MP45S
	220	25.4×35	1.13	0.63	EKMV401VSN221MQ35S
	220	30×25	1.10	0.61	EKMV401VSN221MR25S
	270	22×50	1.30	0.73	EKMV401VSN271MP50S
	270	25.4×40	1.28	0.72	EKMV401VSN271MQ40S
	270	30×30	1.22	0.70	EKMV401VSN271MR30S
	270	35×25	1.26	0.71	EKMV401VSN271MA25S
	330	25.4×45	1.44	0.82	EKMV401VSN331MQ45S
	330	30×35	1.38	0.81	EKMV401VSN331MR35S
	390	25.4×50	1.59	0.91	EKMV401VSN391MQ50S
	390	30×40	1.55	0.91	EKMV401VSN391MR40S
	390	35×30	1.55	0.89	EKMV401VSN391MA30S
	470	30×45	1.74	1.03	EKMV401VSN471MR45S
	470	35×35	1.71	1.00	EKMV401VSN471MA35S
560	30×50	1.93	1.15	EKMV401VSN561MR50S	
560	35×40	1.94	1.14	EKMV401VSN561MA40S	
680	35×45	2.19	1.29	EKMV401VSN681MA45S	
820	35×50	2.45	1.44	EKMV401VSN821MA50S	
1,000	35×60	2.79	1.70	EKMV401VSN102MA60S	
420	82	22×25	0.64	0.34	EKMV421VSN820MP25S
	120	22×30	0.81	0.44	EKMV421VSN121MP30S
	120	25.4×25	0.81	0.44	EKMV421VSN121MQ25S
	150	22×35	0.93	0.50	EKMV421VSN151MP35S
	150	25.4×30	0.93	0.50	EKMV421VSN151MQ30S
	180	22×40	1.04	0.56	EKMV421VSN181MP40S
	180	22×45	1.06	0.58	EKMV421VSN181MP45S
	180	25.4×35	1.06	0.58	EKMV421VSN181MQ35S
	180	30×25	1.02	0.56	EKMV421VSN181MR25S
	220	22×50	1.20	0.66	EKMV421VSN221MP50S
	220	25.4×40	1.20	0.65	EKMV421VSN221MQ40S
	220	30×30	1.14	0.63	EKMV421VSN221MR30S
	270	25.4×45	1.36	0.74	EKMV421VSN271MQ45S
	270	30×35	1.29	0.73	EKMV421VSN271MP35S
	270	35×25	1.26	0.71	EKMV421VSN271MA25S
	330	25.4×50	1.52	0.83	EKMV421VSN331MQ50S
	330	30×40	1.47	0.84	EKMV421VSN331MR40S
	330	35×30	1.42	0.82	EKMV421VSN331MA30S
	390	30×45	1.64	0.94	EKMV421VSN391MR45S
	390	35×35	1.56	0.91	EKMV421VSN391MA35S
470	30×50	1.83	1.06	EKMV421VSN471MR50S	
470	35×40	1.78	1.05	EKMV421VSN471MR40S	
560	35×45	1.98	1.18	EKMV421VSN561MA45S	
680	35×50	2.23	1.34	EKMV421VSN681MA50S	
820	35×60	2.52	1.55	EKMV421VSN821MA60S	
450	82	22×25	0.64	0.34	EKMV451VSN820MP25S
	100	22×30	0.72	0.40	EKMV451VSN101MP30S
	100	25.4×25	0.72	0.40	EKMV451VSN101MQ25S
	120	22×35	0.81	0.45	EKMV451VSN121MP35S
	150	22×40	0.93	0.51	EKMV451VSN151MP40S
	150	25.4×30	0.91	0.50	EKMV451VSN151MQ30S
	150	30×25	0.90	0.51	EKMV451VSN151MR25S
	180	22×45	1.03	0.58	EKMV451VSN181MP45S
	180	22×50	1.06	0.59	EKMV451VSN181MP50S
	180	25.4×35	1.04	0.57	EKMV451VSN181MQ35S
	220	25.4×40	1.18	0.65	EKMV451VSN221MQ40S
	220	25.4×45	1.20	0.67	EKMV451VSN221MQ45S
	220	30×30	1.10	0.63	EKMV451VSN221MR30S
	220	35×25	1.12	0.64	EKMV451VSN221MA25S
	270	25.4×50	1.35	0.75	EKMV451VSN271MQ50S
	270	30×35	1.25	0.73	EKMV451VSN271MR35S
	270	35×30	1.27	0.74	EKMV451VSN271MA30S
	330	30×40	1.42	0.84	EKMV451VSN331MR40S
	330	30×45	1.46	0.87	EKMV451VSN331MR45S
	330	35×35	1.41	0.84	EKMV451VSN331MA35S
390	30×50	1.61	0.97	EKMV451VSN391MR50S	
390	35×40	1.59	0.96	EKMV451VSN391MA40S	
470	35×45	1.79	1.08	EKMV451VSN471MA45S	
560	35×50	2.00	1.22	EKMV451VSN561MA50S	
680	35×60	2.26	1.42	EKMV451VSN681MA60S	



KMV Series

◆ RATED RIPPLE CURRENT MULTIPLIERS

● Frequency Multipliers

Frequency(Hz)	50	120	300	1k	10k	50k
Coefficient	0.77	1.00	1.16	1.30	1.41	1.43

The endurance of capacitors is shorted with internal heating produced by ripple current at the rate of halving the lifetime with every 5°C rise. When long life performance is required in actual use, the rms ripple current has to be reduced.

Screw Terminal Aluminum Electrolytic Capacitors

(Large Capacitors)





PART NUMBERING SYSTEM

Product code guide (Screw mount terminal type)

(Example : KMH series, 400V-3,300 μ F, ϕ 63.5 \times 120L, Without mounting clamp)



Please refer to the following table

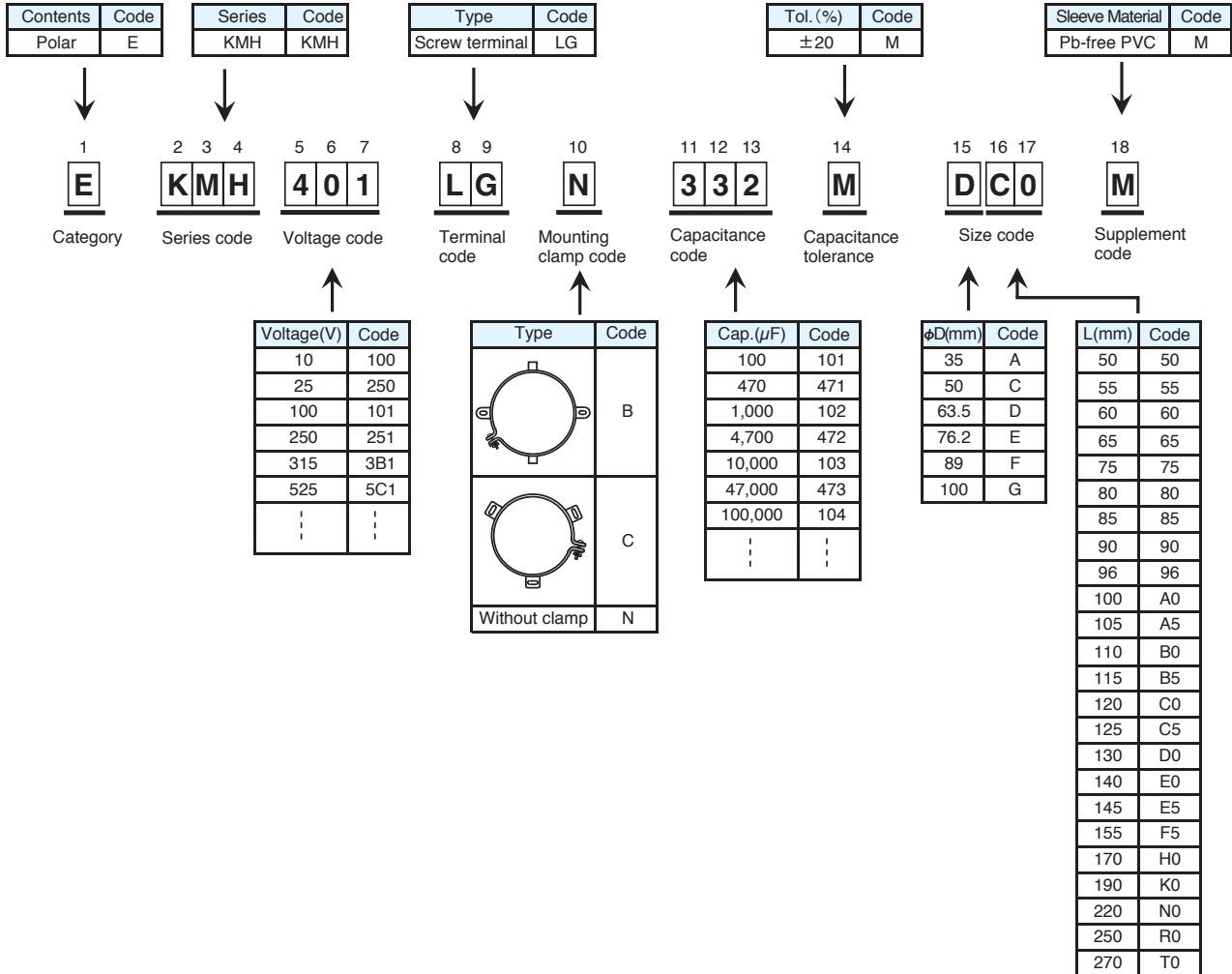

*Refer to the appendix (Part number) for codes not listed here.

SME Series

- Endurance with ripple current : 2,000 hours at 85°C
- RoHS Compliant



◆SPECIFICATIONS

Items	Characteristics						
Category Temperature Range	-40 to +85°C (10 to 100V _{dc})						
Rated Voltage Range	10 to 100V _{dc}						
Capacitance Tolerance	±20% (M) (at 20°C, 120Hz)						
Leakage Current	I=0.02CV or 5mA, whichever is smaller. Where, I : Max. leakage current (μA), C : Nominal capacitance (μF), V : Rated voltage (V) (at 20°C after 5 minutes)						
Dissipation Factor (tanδ)	Shall not exceed the values shown in the STANDARD RATINGS (at 20°C, 120Hz)						
Low Temperature Characteristics	Capacitance change $C(-25^{\circ}\text{C})/C(+20^{\circ}\text{C}) \geq 0.7$ (at 120Hz)						
Insulation Resistance	When measured between the terminals that are connected to each other and to the mounting clamp on the insulating sleeve covering the case by using an insulation resistance meter of 500V _{dc} , the insulation resistance shall not be less than 100MΩ.						
Insulation Withstanding Voltage	When a voltage of 2,000V _{ac} is applied for 1 minute between the terminals that are connected to each other and to the mounting clamp on the insulating sleeve covering the case, there shall not be electrical damage.						
Endurance	The following specifications shall be satisfied when the capacitors are restored to 20°C after subjected to DC voltage with the rated ripple current is applied (the peak voltage shall not exceed the rated voltage) for 2,000 hours at 85°C. <table border="1" style="width: 100%;"> <tr> <td>Capacitance change</td> <td>≤±20% of the initial value</td> </tr> <tr> <td>D.F. (tanδ)</td> <td>≤200% of the initial specified value</td> </tr> <tr> <td>Leakage current</td> <td>≤The initial specified value</td> </tr> </table>	Capacitance change	≤±20% of the initial value	D.F. (tanδ)	≤200% of the initial specified value	Leakage current	≤The initial specified value
Capacitance change	≤±20% of the initial value						
D.F. (tanδ)	≤200% of the initial specified value						
Leakage current	≤The initial specified value						
Shelf Life	The following specifications shall be satisfied when the capacitors are restored to 20°C after exposing them for 500 hours at 85°C without voltage applied. Before the measurement, the capacitor shall be preconditioned by applying voltage according to Item 4.1 of JIS C 5101-4. <table border="1" style="width: 100%;"> <tr> <td>Capacitance change</td> <td>≤±20% of the initial value</td> </tr> <tr> <td>D.F. (tanδ)</td> <td>≤150% of the initial specified value</td> </tr> <tr> <td>Leakage current</td> <td>≤The initial specified value</td> </tr> </table>	Capacitance change	≤±20% of the initial value	D.F. (tanδ)	≤150% of the initial specified value	Leakage current	≤The initial specified value
Capacitance change	≤±20% of the initial value						
D.F. (tanδ)	≤150% of the initial specified value						
Leakage current	≤The initial specified value						

◆DIMENSIONS (Screw-Mount) [mm]

- Terminal Code : LG

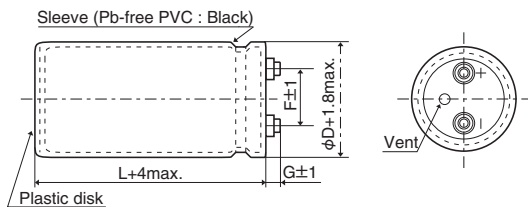

φ35 to φ63.5 : G=6
φ76.2 & φ89 : G=5

<Screw specifications>

Plus hexagon-headed screw :M5×0.8×10

Maximum screw tightening torque :3.23Nm

* The screw and the mounting clamp are separately supplied and not attached to the product.

- Mounting Clamp Code : B

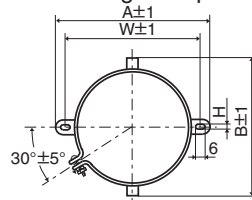

φD	A	B	W	H	F
35	58.0	44.0	48.0	3.5	12.7
50	78.0	64.0	68.0	4.5	22.4
63.5	90.0	76.0	80.0	4.5	28.0
76.2	104.5	90.0	93.5	4.5	31.5

- Mounting Clamp Code : C

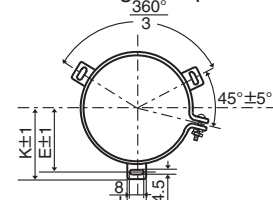

φD	E	K	J	F
50	32.5	37.0	14.0	22.4
63.5	38.1	43.5	14.0	28.0
76.2	44.5	50.0	14.0	31.5
89	50.8	56.5	16.0	31.5

◆PART NUMBERING SYSTEM

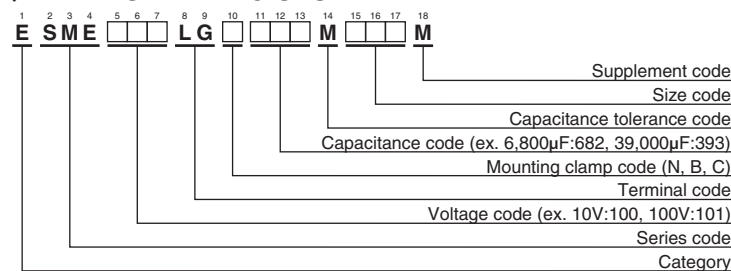

Please refer to "Product code guide (screw-mount terminal type)"

◆STANDARD RATINGS

WV (Vdc)	Cap (μF)	Case size φD×L(mm)	tanδ	Rated ripple current (Arms/85°C, 120Hz)	Part No.	WV (Vdc)	Cap (μF)	Case size φD×L(mm)	tanδ	Rated ripple current (Arms/85°C, 120Hz)	Part No.
10	39,000	35×50	0.60	4.70	ESME100LGB393MA50M	50	10,000	35×50	0.25	4.10	ESME500LGB103MA50M
	82,000	35×80	0.60	7.40	ESME100LGB823MA80M		18,000	35×80	0.25	5.20	ESME500LGB183MA80M
	100,000	35×100	0.70	8.00	ESME100LGB104MAA0M		22,000	35×100	0.30	5.90	ESME500LGB223MAA0M
	120,000	35×120	0.70	9.40	ESME100LGB124MAC0M		27,000	35×120	0.35	6.60	ESME500LGB273MAC0M
	150,000	50×80	0.90	9.80	ESME100LGC154MC80M		39,000	50×80	0.40	7.40	ESME500LGC393MC80M
	220,000	50×100	1.00	12.1	ESME100LGC224MCA0M		56,000	50×100	0.40	9.80	ESME500LGC563MCA0M
	270,000	50×120	1.20	13.6	ESME100LGC274MCC0M		68,000	50×120	0.45	11.1	ESME500LGC683MCC0M
	390,000	63.5×100	1.50	15.3	ESME100LGC394MDA0M		82,000	63.5×100	0.50	12.2	ESME500LGC823MDA0M
	470,000	63.5×120	2.00	16.0	ESME100LGC474MDC0M		120,000	63.5×120	0.50	16.0	ESME500LGC124MDC0M
	560,000	76.2×100	2.50	17.3	ESME100LGC564MEA0M		150,000	76.2×120	0.60	18.1	ESME500LGC154MEC0M
680,000	76.2×120	3.00	18.7	ESME100LGC684MEC0M	180,000	76.2×140	0.70	19.5	ESME500LGC184MEE0M		
16	27,000	35×50	0.45	4.20	ESME160LGB273MA50M	270,000	89×140	0.80	24.6	ESME500LGC274MFE0M	
	56,000	35×80	0.60	6.50	ESME160LGB563MA80M	63	5,600	35×50	0.20	3.00	ESME630LGB562MA50M
	82,000	35×100	0.70	8.00	ESME160LGB823MAA0M		10,000	35×80	0.25	4.00	ESME630LGB103MA80M
	100,000	35×120	0.70	9.60	ESME160LGB104MAC0M		15,000	35×100	0.25	5.30	ESME630LGB153MAA0M
	120,000	50×80	0.80	9.60	ESME160LGC124MC80M		18,000	35×120	0.25	6.20	ESME630LGB183MAC0M
	150,000	50×100	0.90	11.2	ESME160LGC154MCA0M		22,000	50×80	0.30	6.50	ESME630LGC223MC80M
	220,000	50×120	1.00	14.2	ESME160LGC224MCC0M		33,000	50×100	0.35	8.10	ESME630LGC333MCA0M
	270,000	63.5×100	1.20	15.3	ESME160LGC274MDA0M		39,000	50×120	0.35	9.60	ESME630LGC393MCC0M
	330,000	63.5×120	1.30	17.1	ESME160LGC334MDC0M		47,000	63.5×100	0.40	10.2	ESME630LGC473MDA0M
	390,000	76.2×100	1.60	18.0	ESME160LGC394MEA0M		68,000	63.5×120	0.40	13.3	ESME630LGC683MDC0M
470,000	76.2×120	1.80	19.3	ESME160LGC474MEC0M	100,000		76.2×120	0.45	17.1	ESME630LGC104MEC0M	
560,000	76.2×140	2.00	20.7	ESME160LGC564MEE0M	120,000	76.2×140	0.50	19.0	ESME630LGC124MEE0M		
25	18,000	35×50	0.35	4.00	ESME250LGB183MA50M	150,000	89×140	0.55	22.0	ESME630LGC154MFE0M	
	39,000	35×80	0.40	6.20	ESME250LGB393MA80M	80	3,300	35×50	0.15	2.50	ESME800LGB332MA50M
	47,000	35×100	0.40	7.40	ESME250LGB473MAA0M		6,800	35×80	0.20	3.70	ESME800LGB682MA80M
	56,000	35×120	0.45	8.30	ESME250LGB563MAC0M		10,000	35×100	0.20	4.90	ESME800LGB103MAA0M
	82,000	50×80	0.50	9.70	ESME250LGC823MC80M		12,000	35×120	0.20	5.40	ESME800LGB123MAC0M
	100,000	50×100	0.60	10.8	ESME250LGC104MCA0M		15,000	50×80	0.25	6.00	ESME800LGC153MC80M
	120,000	50×120	0.60	12.8	ESME250LGC124MCC0M		22,000	50×100	0.30	7.10	ESME800LGC223MCA0M
	180,000	63.5×100	0.75	14.7	ESME250LGC184MDA0M		27,000	50×120	0.30	8.60	ESME800LGC273MCC0M
	220,000	63.5×120	0.80	16.8	ESME250LGC224MDC0M		33,000	63.5×100	0.35	9.30	ESME800LGC333MDA0M
	270,000	76.2×100	0.90	18.3	ESME250LGC274MEA0M		47,000	63.5×120	0.35	12.0	ESME800LGC473MDC0M
330,000	76.2×120	1.00	20.7	ESME250LGC334MEC0M	68,000		76.2×120	0.35	15.4	ESME800LGC683MEC0M	
390,000	76.2×140	1.20	22.1	ESME250LGC394MEE0M	82,000	76.2×140	0.35	18.1	ESME800LGC823MEE0M		
560,000	89×140	1.50	25.8	ESME250LGC564MFE0M	100,000	89×140	0.40	21.0	ESME800LGC104MFE0M		
35	15,000	35×50	0.30	3.90	ESME350LGB153MA50M	100	2,200	35×50	0.10	2.50	ESME101LGB222MA50M
	33,000	35×80	0.40	6.00	ESME350LGB333MA80M		4,700	35×80	0.15	3.40	ESME101LGB472MA80M
	39,000	35×100	0.40	7.00	ESME350LGB393MAA0M		6,800	35×100	0.15	4.20	ESME101LGB682MAA0M
	47,000	35×120	0.45	8.00	ESME350LGB473MAC0M		8,200	35×120	0.15	5.00	ESME101LGB822MAC0M
	68,000	50×80	0.50	9.00	ESME350LGC683MC80M		10,000	50×80	0.20	5.20	ESME101LGC103MC80M
	82,000	50×100	0.55	10.3	ESME350LGC823MCA0M		18,000	50×120	0.20	8.10	ESME101LGC183MCC0M
	120,000	50×120	0.60	12.8	ESME350LGC124MCC0M		22,000	63.5×100	0.25	8.60	ESME101LGC223MDA0M
	150,000	63.5×100	0.70	14.0	ESME350LGC154MDA0M		27,000	63.5×120	0.25	10.3	ESME101LGC273MDC0M
	180,000	63.5×120	0.70	16.6	ESME350LGC184MDC0M		33,000	76.2×100	0.25	11.1	ESME101LGC333MEA0M
	220,000	76.2×100	0.75	17.3	ESME350LGC224MEA0M		39,000	76.2×120	0.25	12.4	ESME101LGC393MEC0M
270,000	76.2×120	0.80	19.8	ESME350LGC274MEC0M	47,000	76.2×140	0.25	14.3	ESME101LGC473MEE0M		
330,000	76.2×140	0.90	22.5	ESME350LGC334MEE0M	68,000	89×140	0.30	18.0	ESME101LGC683MFE0M		
470,000	89×140	1.00	28.3	ESME350LGC474MFE0M							

◆RATED RIPPLE CURRENT MULTIPLIERS

●Frequency Multipliers

Rated voltage (Vdc)	Case diameter (mm)	Frequency (Hz)					
		50	120	300	1k	10k	50k
10 to 50	φ35 to φ89	0.95	1.00	1.03	1.05	1.09	1.12
	φ35	0.90	1.00	1.06	1.10	1.18	1.22
63 & 80	φ50 to φ89	0.95	1.00	1.03	1.05	1.09	1.12
	φ35	0.82	1.00	1.12	1.22	1.30	1.33
100	φ50	0.90	1.00	1.06	1.10	1.18	1.22
	φ63.5 to φ89	0.95	1.00	1.03	1.05	1.09	1.12

The endurance of capacitors is reduced with internal heating produced by ripple current at the rate of halving the lifetime with every 5°C rise. When long life performance is required in actual use, the rms ripple current has to be reduced.

New!

KMQ Series

- Endurance with ripple current : 2,000 hours at 105°C
- Downsized and high ripple current from KMH series
- RoHS Compliant

KMQ

↑
Downsized
Higher ripple
KMH



◆SPECIFICATIONS

Items	Characteristics						
Category							
Temperature Range	-25 to +105°C						
Rated Voltage Range	315 to 450V _{dc}						
Capacitance Tolerance	±20% (M) (at 20°C, 120Hz)						
Leakage Current	I=0.02CV or 5mA, whichever is smaller. Where, I : Max. leakage current (μA), C : Nominal capacitance (μF), V : Rated voltage (V) (at 20°C after 5 minutes)						
Dissipation Factor (tanδ)	Shall not exceed the values shown in the STANDARD RATINGS (at 20°C, 120Hz)						
Low Temperature Characteristics	Capacitance change C(-25°C)/C(+20°C)≥0.7 (at 120Hz)						
Insulation Resistance	When measured between the terminals that are connected to each other and to the mounting clamp on the insulating sleeve covering the case by using an insulation resistance meter of 500V _{dc} , the insulation resistance shall not be less than 100MΩ.						
Insulation Withstanding Voltage	When a voltage of 2,000Vac is applied for 1 minute between the terminals that are connected to each other and to the mounting clamp on the insulating sleeve covering the case, there shall not be electrical damage.						
Endurance	The following specifications shall be satisfied when the capacitors are restored to 20°C after subjected to DC voltage with the rated ripple current is applied (the peak voltage shall not exceed the rated voltage) for 2,000 hours at 105°C. <table border="1"> <tr> <td>Capacitance change</td> <td>≤±20% of the initial value</td> </tr> <tr> <td>D.F. (tanδ)</td> <td>≤200% of the initial specified value</td> </tr> <tr> <td>Leakage current</td> <td>≤The initial specified value</td> </tr> </table>	Capacitance change	≤±20% of the initial value	D.F. (tanδ)	≤200% of the initial specified value	Leakage current	≤The initial specified value
Capacitance change	≤±20% of the initial value						
D.F. (tanδ)	≤200% of the initial specified value						
Leakage current	≤The initial specified value						
Shelf Life	The following specifications shall be satisfied when the capacitors are restored to 20°C after exposing them for 500 hours at 105°C without voltage applied. Before the measurement, the capacitor shall be preconditioned by applying voltage according to Item 4.1 of JIS C 5101-4. <table border="1"> <tr> <td>Capacitance change</td> <td>≤±20% of the initial value</td> </tr> <tr> <td>D.F. (tanδ)</td> <td>≤200% of the initial specified value</td> </tr> <tr> <td>Leakage current</td> <td>≤The initial specified value</td> </tr> </table>	Capacitance change	≤±20% of the initial value	D.F. (tanδ)	≤200% of the initial specified value	Leakage current	≤The initial specified value
Capacitance change	≤±20% of the initial value						
D.F. (tanδ)	≤200% of the initial specified value						
Leakage current	≤The initial specified value						

◆DIMENSIONS (Screw-Mount) [mm]

●Terminal Code : LG

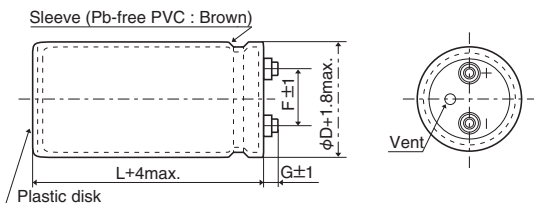

●Mounting Clamp Code : B

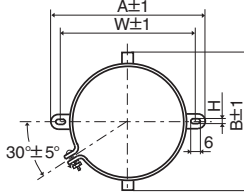

φD	A	B	W	H	F
35	58.0	44.0	48.0	3.5	12.7
50	78.0	64.0	68.0	4.5	22.4
63.5	90.0	76.0	80.0	4.5	28.0
76.2	104.5	90.0	93.5	4.5	31.5

●Mounting Clamp Code : C

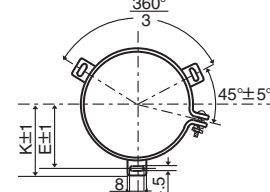

φD	E	K	J	F
50	32.5	37.0	14.0	22.4
63.5	38.1	43.5	14.0	28.0
76.2	44.5	50.0	14.0	31.5
89	50.8	56.5	16.0	31.5

φ35 to φ63.5 : G=6
φ76.2 & φ89 : G=5

<Screw specifications>

Plus hexagon-headed screw :M5×0.8×10

Maximum screw tightening torque :3.23Nm

* The screw and the mounting clamp are separately supplied and not attached to the product.

◆PART NUMBERING SYSTEM

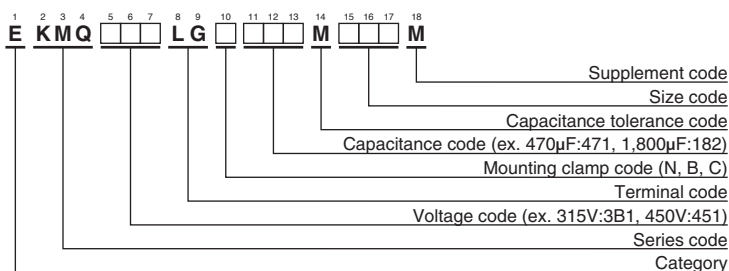

Please refer to "Product code guide (screw-mount terminal type)"

◆STANDARD RATINGS

WV (Vdc)	Cap (μF)	Case size φD×L(mm)	tan δ	Rated ripple current (Arms/105°C,120Hz)	Part No.	WV (Vdc)	Cap (μF)	Case size φD×L(mm)	tan δ	Rated ripple current (Arms/105°C,120Hz)	Part No.
315	560	35×55	0.10	2.4	EKMQ3B1LGB561MA55M	400	390	35×55	0.10	2.0	EKMQ401LGB391MA55M
	680	35×65	0.15	2.9	EKMQ3B1LGB681MA65M		470	35×60	0.10	2.3	EKMQ401LGB471MA60M
	820	35×75	0.15	3.3	EKMQ3B1LGB821MA75M		560	35×70	0.15	2.7	EKMQ401LGB561MA70M
	1,000	35×80	0.15	3.8	EKMQ3B1LGB102MA80M		680	35×80	0.15	3.1	EKMQ401LGB681MA80M
	1,200	35×100	0.15	4.5	EKMQ3B1LGB122MAA0M		820	35×90	0.15	3.6	EKMQ401LGB821MA90M
	1,500	50×70	0.15	5.4	EKMQ3B1LGC152MC70M		1,000	50×65	0.15	4.2	EKMQ401LGC102MC65M
	1,800	50×75	0.15	6.0	EKMQ3B1LGC182MC75M		1,200	50×75	0.15	4.9	EKMQ401LGC122MC75M
	2,200	50×90	0.15	7.2	EKMQ3B1LGC222MC90M		1,500	50×85	0.15	5.8	EKMQ401LGC152MC85M
	2,700	50×100	0.15	8.4	EKMQ3B1LGC272MCA0M		2,200	63.5×85	0.15	8.1	EKMQ401LGC222MD85M
	3,300	63.5×85	0.15	9.9	EKMQ3B1LGC332MD85M		3,300	63.5×105	0.15	10.8	EKMQ401LGC332MDA5M
	3,900	63.5×96	0.15	11.3	EKMQ3B1LGC392MD96M		4,700	76.2×105	0.15	14.3	EKMQ401LGC472MEA5M
	4,700	76.2×85	0.15	13.1	EKMQ3B1LGC472ME85M		5,600	89×96	0.15	13.9	EKMQ401LGC562MF96M
	5,600	76.2×96	0.15	15.0	EKMQ3B1LGC562ME96M		6,800	89×115	0.15	16.6	EKMQ401LGC682MFB5M
	6,800	76.2×110	0.15	17.6	EKMQ3B1LGC682MEB0M		8,200	89×130	0.15	19.2	EKMQ401LGC822MFD0M
8,200	89×100	0.15	17.2	EKMQ3B1LGC822MFA0M	450	330	35×55	0.10	1.8	EKMQ451LGB331MA55M	
10,000	89×115	0.15	20.1	EKMQ3B1LGC103MFB5M		390	35×65	0.10	2.2	EKMQ451LGB391MA65M	
350	470	35×55	0.10	2.2		EKMQ351LGB471MA55M	470	35×75	0.10	2.5	EKMQ451LGB471MA75M
	560	35×60	0.10	2.5		EKMQ351LGB561MA60M	560	35×80	0.15	2.8	EKMQ451LGB561MA80M
	680	35×70	0.15	2.9		EKMQ351LGB681MA70M	680	35×100	0.15	3.5	EKMQ451LGB681MAA0M
	820	35×80	0.15	3.4		EKMQ351LGB821MA80M	820	35×110	0.15	4.1	EKMQ451LGB821MAB0M
	1,000	35×90	0.15	4.0		EKMQ351LGB102MA90M	1,000	50×80	0.15	4.6	EKMQ451LGC102MC80M
	1,200	50×65	0.15	4.6		EKMQ351LGC122MC65M	1,200	50×90	0.15	5.3	EKMQ451LGC122MC90M
	1,500	50×75	0.15	5.5		EKMQ351LGC152MC75M	1,500	50×105	0.15	6.4	EKMQ451LGC152MCA5M
	1,800	50×85	0.15	6.4		EKMQ351LGC182MC85M	2,200	63.5×96	0.15	8.5	EKMQ451LGC222MD96M
	2,200	50×100	0.15	7.6		EKMQ351LGC222MCA0M	3,300	63.5×130	0.15	11.9	EKMQ451LGC332MDD0M
	2,700	63.5×85	0.15	9.0		EKMQ351LGC272MD85M	4,700	76.2×130	0.15	15.7	EKMQ451LGC472MED0M
	3,900	76.2×80	0.15	11.7		EKMQ351LGC392ME80M	5,600	76.2×155	0.15	18.5	EKMQ451LGC562MEF5M
	5,600	76.2×105	0.15	15.6		EKMQ351LGC562MEA5M	5,600	89×120	0.15	15.3	EKMQ451LGC562MFC0M
	6,800	76.2×125	0.15	18.6	EKMQ351LGC682MEC5M	6,800	89×140	0.15	18.0	EKMQ451LGC682MFE0M	
	8,200	89×115	0.15	18.2	EKMQ351LGC822MFB5M	8,200	89×170	0.15	21.6	EKMQ451LGC822MFH0M	

◆RATED RIPPLE CURRENT MULTIPLIERS

●Frequency Multipliers

Frequency (Hz)	50Hz	120Hz	300Hz	1kHz	3kHz
φ 35, 50	0.70	1.00	1.30	1.70	1.80
φ 63.5 to 89	0.80	1.00	1.10	1.15	1.15

The endurance of capacitors is reduced with internal heating produced by ripple current at the rate of halving the lifetime with every 5°C rise. When long life performance is required in actual use, the rms ripple current has to be reduced.



LARGE CAPACITANCE ALUMINUM ELECTROLYTIC CAPACITORS Standard screw terminals, 105°C

KMH Series

- Endurance with ripple current : 2,000 hours at 105°C
- RoHS Compliant

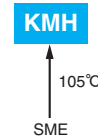

◆SPECIFICATIONS

Items	Characteristics						
Category Temperature Range	-40 to +105°C (10 to 100V _{dc}) -25 to +105°C (160 to 400V _{dc})						
Rated Voltage Range	10 to 400V _{dc}						
Capacitance Tolerance	±20% (M) (at 20°C, 120Hz)						
Leakage Current	I=0.02CV or 5mA, whichever is smaller. Where, I : Max. leakage current (μA), C : Nominal capacitance (μF), V : Rated voltage (V) (at 20°C after 5 minutes)						
Dissipation Factor (tanδ)	Shall not exceed the values shown in the STANDARD RATINGS (at 20°C, 120Hz)						
Low Temperature Characteristics	Capacitance change 10 to 100V _{dc} : C(-40°C)/C(+20°C)≥0.6 160 to 400V _{dc} : C(-25°C)/C(+20°C)≥0.7 (at 120Hz)						
Insulation Resistance	When measured between the terminals that are connected to each other and to the mounting clamp on the insulating sleeve covering the case by using an insulation resistance meter of 500V _{dc} , the insulation resistance shall not be less than 100MΩ.						
Insulation Withstanding Voltage	When a voltage of 2,000Vac is applied for 1 minute between the terminals that are connected to each other and to the mounting clamp on the insulating sleeve covering the case, there shall not be electrical damage.						
Endurance	The following specifications shall be satisfied when the capacitors are restored to 20°C after subjected to DC voltage with the rated ripple current is applied (the peak voltage shall not exceed the rated voltage) for 2,000 hours at 105°C.						
	<table border="1" style="width:100%"> <tr> <td>Capacitance change</td> <td>≤±20% of the initial value</td> </tr> <tr> <td>D.F. (tanδ)</td> <td>≤200% of the initial specified value</td> </tr> <tr> <td>Leakage current</td> <td>≤The initial specified value</td> </tr> </table>	Capacitance change	≤±20% of the initial value	D.F. (tanδ)	≤200% of the initial specified value	Leakage current	≤The initial specified value
Capacitance change	≤±20% of the initial value						
D.F. (tanδ)	≤200% of the initial specified value						
Leakage current	≤The initial specified value						
Shelf Life	The following specifications shall be satisfied when the capacitors are restored to 20°C after exposing them for 500 hours at 105°C without voltage applied. Before the measurement, the capacitor shall be preconditioned by applying voltage according to Item 4.1 of JIS C 5101-4.						
	<table border="1" style="width:100%"> <tr> <td>Capacitance change</td> <td>≤±20% of the initial value</td> </tr> <tr> <td>D.F. (tanδ)</td> <td>≤200% of the initial specified value</td> </tr> <tr> <td>Leakage current</td> <td>≤The initial specified value</td> </tr> </table>	Capacitance change	≤±20% of the initial value	D.F. (tanδ)	≤200% of the initial specified value	Leakage current	≤The initial specified value
Capacitance change	≤±20% of the initial value						
D.F. (tanδ)	≤200% of the initial specified value						
Leakage current	≤The initial specified value						

◆DIMENSIONS (Screw-Mount) [mm]

- Terminal Code : LG

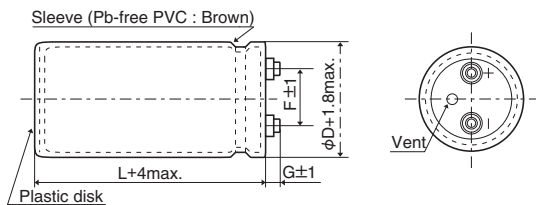

φ35 to φ63.5 : G=6
φ76.2 & φ89 : G=5

- Mounting Clamp Code : B

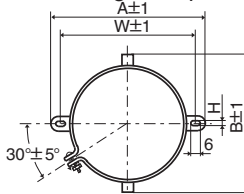

φD	A	B	W	H	F
35	58.0	44.0	48.0	3.5	12.7
50	78.0	64.0	68.0	4.5	22.4
63.5	90.0	76.0	80.0	4.5	28.0
76.2	104.5	90.0	93.5	4.5	31.5

- Mounting Clamp Code : C

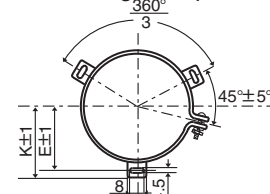

φD	E	K	J	F
50	32.5	37.0	14.0	22.4
63.5	38.1	43.5	14.0	28.0
76.2	44.5	50.0	14.0	31.5
89	50.8	56.5	16.0	31.5

<Screw specifications>

Plus hexagon-headed screw :M5×0.8×10

Maximum screw tightening torque :3.23Nm

* The screw and the mounting clamp are separately supplied and not attached to the product.

◆PART NUMBERING SYSTEM

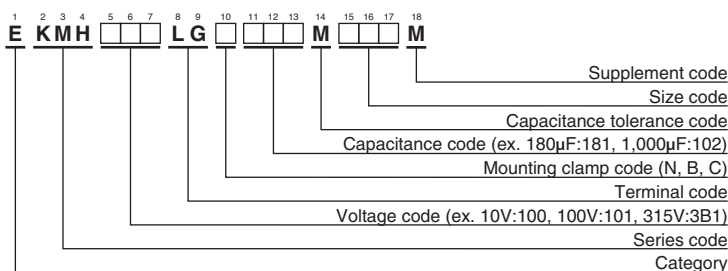

Please refer to "Product code guide (screw-mount terminal type)"

◆STANDARD RATINGS

WV (Vdc)	Cap (μF)	Case size φD×L(mm)	tanδ	Rated ripple current (Arms/105°C, 120Hz)	Part No.	WV (Vdc)	Cap (μF)	Case size φD×L(mm)	tanδ	Rated ripple current (Arms/105°C, 120Hz)	Part No.	
10	27,000	35×50	0.45	4.90	EKMH100LGB273MA50M	35	56,000	50×100	0.40	11.4	EKMH350LGC563MA0M	
	33,000	35×50	0.50	5.10	EKMH100LGB333MA50M		68,000	50×120	0.40	13.6	EKMH350LGC683MCC0M	
	39,000	35×60	0.50	5.90	EKMH100LGB393MA60M		82,000	63.5×100	0.45	14.8	EKMH350LGC823MDA0M	
	47,000	35×80	0.50	7.10	EKMH100LGB473MA80M		100,000	63.5×120	0.45	17.6	EKMH350LGC104MDC0M	
	56,000	35×80	0.60	7.10	EKMH100LGB563MA80M		120,000	63.5×120	0.55	17.6	EKMH350LGC124MDC0M	
	68,000	35×100	0.60	8.50	EKMH100LGB683MAA0M		150,000	76.2×120	0.65	19.8	EKMH350LGC154MEC0M	
	82,000	35×100	0.65	8.90	EKMH100LGB823MAA0M		180,000	76.2×120	0.80	19.8	EKMH350LGC184MEC0M	
	100,000	35×120	0.65	10.7	EKMH100LGB104MAC0M		220,000	76.2×140	0.80	23.4	EKMH350LGC224MEE0M	
	120,000	50×80	0.75	11.0	EKMH100LGC124MC80M		270,000	89×140	1.00	25.5	EKMH350LGC274MFE0M	
	150,000	50×100	0.80	13.2	EKMH100LGC154MCA0M		50	3,900	35×50	0.20	2.80	EKMH500LGB392MA50M
	180,000	50×120	0.80	15.7	EKMH100LGC184MCC0M			4,700	35×50	0.20	3.10	EKMH500LGB472MA50M
	220,000	50×120	0.85	16.8	EKMH100LGC224MCC0M			5,600	35×50	0.20	3.30	EKMH500LGB562MA50M
	270,000	63.5×120	1.00	19.6	EKMH100LGC274MDC0M			6,800	35×50	0.25	3.30	EKMH500LGB682MA50M
	330,000	63.5×120	1.20	19.7	EKMH100LGC334MDC0M			8,200	35×60	0.25	3.80	EKMH500LGB822MA60M
	390,000	76.2×120	1.50	21.3	EKMH100LGC394MEC0M			10,000	35×80	0.25	4.60	EKMH500LGB103MA80M
	470,000	76.2×120	1.80	21.4	EKMH100LGC474MEC0M			12,000	35×80	0.25	5.10	EKMH500LGB123MA80M
	560,000	76.2×140	2.00	23.6	EKMH100LGC564MEE0M			15,000	35×80	0.25	5.70	EKMH500LGB153MA80M
	680,000	89×140	2.40	26.0	EKMH100LGC684MFE0M			18,000	35×100	0.25	6.70	EKMH500LGB183MAA0M
16	18,000	35×50	0.40	4.20	EKMH160LGB183MA50M	22,000		35×120	0.25	8.10	EKMH500LGB223MAC0M	
	22,000	35×50	0.40	4.70	EKMH160LGB223MA50M	27,000		50×80	0.25	9.10	EKMH500LGC273MC80M	
	27,000	35×60	0.40	5.50	EKMH160LGB273MA60M	33,000		50×100	0.25	11.1	EKMH500LGC333MCA0M	
	33,000	35×60	0.45	5.70	EKMH160LGB333MA60M	39,000		50×120	0.25	13.1	EKMH500LGC393MCC0M	
	39,000	35×80	0.45	6.80	EKMH160LGB393MA80M	47,000		50×120	0.30	13.9	EKMH500LGC473MCC0M	
	47,000	35×80	0.50	7.10	EKMH160LGB473MA80M	56,000		63.5×100	0.35	13.9	EKMH500LGC563MDA0M	
	56,000	35×100	0.50	8.40	EKMH160LGB563MAA0M	68,000		63.5×120	0.35	16.6	EKMH500LGC683MDC0M	
	68,000	35×100	0.55	8.80	EKMH160LGB683MAA0M	82,000		76.2×120	0.40	18.9	EKMH500LGC823MEC0M	
	82,000	50×80	0.55	10.7	EKMH160LGC823MC80M	100,000		76.2×120	0.45	19.5	EKMH500LGC104MEC0M	
	100,000	50×80	0.65	10.8	EKMH160LGC104MC80M	120,000	76.2×120	0.55	19.5	EKMH500LGC124MEC0M		
	120,000	50×100	0.65	13.1	EKMH160LGC124MCA0M	150,000	89×140	0.60	23.9	EKMH500LGC154MFE0M		
	150,000	50×120	0.70	15.3	EKMH160LGC154MCC0M	180,000	89×140	0.75	23.9	EKMH500LGC184MFE0M		
	180,000	50×120	0.80	15.7	EKMH160LGC184MCC0M	63	2,700	35×50	0.20	2.30	EKMH630LGB272MA50M	
	220,000	63.5×120	0.85	19.2	EKMH160LGC224MDC0M		3,300	35×50	0.20	2.50	EKMH630LGB332MA50M	
	270,000	63.5×120	1.00	19.6	EKMH160LGC274MDC0M		3,900	35×50	0.20	2.80	EKMH630LGB392MA50M	
	330,000	76.2×120	1.30	21.1	EKMH160LGC334MEC0M		4,700	35×50	0.20	3.10	EKMH630LGB472MA50M	
	390,000	76.2×120	1.50	21.3	EKMH160LGC394MEC0M		5,600	35×60	0.20	3.50	EKMH630LGB562MA60M	
	470,000	76.2×140	1.60	24.2	EKMH160LGC474MEE0M		6,800	35×60	0.20	3.90	EKMH630LGB682MA60M	
560,000	89×140	2.00	28.1	EKMH160LGC564MFE0M	8,200		35×80	0.20	4.70	EKMH630LGB822MA80M		
680,000	89×140	2.40	28.5	EKMH160LGC684MFE0M	10,000		35×80	0.25	4.70	EKMH630LGB103MA80M		
25	12,000	35×50	0.35	3.70	EKMH250LGB123MA50M		12,000	35×100	0.25	5.50	EKMH630LGB123MAA0M	
	15,000	35×50	0.35	4.10	EKMH250LGB153MA50M		15,000	35×120	0.25	6.60	EKMH630LGB153MAC0M	
	18,000	35×60	0.35	4.80	EKMH250LGB183MA60M		18,000	50×80	0.25	7.40	EKMH630LGC183MCA0M	
	22,000	35×60	0.35	5.30	EKMH250LGB223MA60M		22,000	50×100	0.25	9.00	EKMH630LGC223MCA0M	
	27,000	35×80	0.35	6.40	EKMH250LGB273MA80M		27,000	50×120	0.25	10.9	EKMH630LGC273MCC0M	
	33,000	35×80	0.40	6.70	EKMH250LGB333MA80M		33,000	50×120	0.25	12.0	EKMH630LGC333MCC0M	
	39,000	35×100	0.40	7.80	EKMH250LGB393MAA0M		39,000	63.5×100	0.30	12.5	EKMH630LGC393MDA0M	
	47,000	35×120	0.40	9.30	EKMH250LGB473MAC0M		47,000	63.5×120	0.30	14.9	EKMH630LGC473MDC0M	
	56,000	50×80	0.45	9.70	EKMH250LGC563MC80M		56,000	63.5×120	0.30	16.3	EKMH630LGC563MDC0M	
	68,000	50×100	0.45	11.2	EKMH250LGC683MCA0M		68,000	76.2×120	0.35	18.4	EKMH630LGC683MEC0M	
	82,000	50×100	0.50	11.2	EKMH250LGC823MCA0M	82,000	76.2×140	0.40	20.0	EKMH630LGC823MEE0M		
	100,000	50×120	0.50	14.8	EKMH250LGC104MCC0M	100,000	76.2×140	0.50	20.0	EKMH630LGC104MEE0M		
	120,000	63.5×100	0.65	14.9	EKMH250LGC124MDA0M	120,000	89×140	0.60	21.8	EKMH630LGC124MFE0M		
	150,000	63.5×120	0.65	17.9	EKMH250LGC154MDC0M	80	2,200	35×50	0.15	2.40	EKMH800LGB222MA50M	
	180,000	63.5×120	0.80	17.9	EKMH250LGC184MDC0M		2,700	35×50	0.15	2.70	EKMH800LGB272MA50M	
	220,000	76.2×120	0.85	21.3	EKMH250LGC224MEC0M		3,300	35×50	0.15	3.00	EKMH800LGB332MA50M	
	270,000	76.2×120	1.00	21.7	EKMH250LGC274MEC0M		3,900	35×60	0.15	3.40	EKMH800LGB392MA60M	
	330,000	76.2×140	1.20	23.4	EKMH250LGC334MEE0M		4,700	35×60	0.15	3.70	EKMH800LGB472MA60M	
390,000	89×140	1.50	24.9	EKMH250LGC394MFE0M	5,600		35×80	0.15	4.50	EKMH800LGB562MA80M		
35	8,200	35×50	0.30	3.30	EKMH350LGB822MA50M		6,800	35×80	0.15	4.90	EKMH800LGB682MA80M	
	10,000	35×50	0.30	3.60	EKMH350LGB103MA50M		8,200	35×100	0.20	5.10	EKMH800LGB822MAA0M	
	12,000	35×60	0.30	4.20	EKMH350LGB123MA60M		10,000	35×120	0.20	6.10	EKMH800LGB103MAC0M	
	15,000	35×60	0.30	4.70	EKMH350LGB153MA60M		12,000	50×80	0.20	6.70	EKMH800LGC123MCA0M	
	18,000	35×80	0.30	5.70	EKMH350LGB183MA80M		15,000	50×100	0.20	8.30	EKMH800LGC153MCA0M	
	22,000	35×80	0.30	6.30	EKMH350LGB223MA80M		18,000	50×120	0.20	9.90	EKMH800LGC183MCC0M	
	27,000	35×100	0.30	7.50	EKMH350LGB273MAA0M		22,000	50×120	0.20	11.0	EKMH800LGC223MCC0M	
	33,000	35×120	0.30	9.00	EKMH350LGB333MCA0M		27,000	63.5×100	0.25	11.4	EKMH800LGC273MDA0M	
	39,000	50×80	0.35	9.20	EKMH350LGC393MC80M		33,000	76.2×100	0.25	13.9	EKMH800LGC333MEA0M	
	47,000	50×100	0.35	11.2	EKMH350LGC473MCA0M		39,000	76.2×100	0.30	13.9	EKMH800LGC393MEA0M	



◆STANDARD RATINGS

WV (Vdc)	Cap (μF)	Case size φD×L(mm)	tanδ	Rated ripple current (Arms/105°C,120Hz)	Part No.	WV (Vdc)	Cap (μF)	Case size φD×L(mm)	tanδ	Rated ripple current (Arms/105°C,120Hz)	Part No.	
80	47,000	76.2×120	0.30	16.5	EKMH800LGC473MEC0M	250	330	35×50	0.15	0.90	EKMH251LGB331MA50M	
	56,000	76.2×120	0.30	18.1	EKMH800LGC563MEC0M		390	35×50	0.15	1.00	EKMH251LGB391MA50M	
	68,000	76.2×140	0.35	19.7	EKMH800LGC683MEE0M		470	35×50	0.15	1.10	EKMH251LGB471MA50M	
	82,000	89×140	0.40	22.1	EKMH800LGC823MFE0M		560	35×50	0.15	1.20	EKMH251LGB561MA50M	
100	1,800	35×50	0.10	2.70	EKMH101LGB182MA50M		680	35×60	0.15	1.40	EKMH251LGB681MA60M	
	2,200	35×50	0.10	3.00	EKMH101LGB222MA50M		820	35×80	0.15	1.60	EKMH251LGB821MA80M	
	2,700	35×60	0.10	3.50	EKMH101LGB272MA60M		1,000	35×80	0.20	1.60	EKMH251LGB102MA80M	
	3,300	35×80	0.10	4.20	EKMH101LGB332MA80M		1,200	35×80	0.20	1.80	EKMH251LGB122MA80M	
	3,900	35×80	0.12	4.20	EKMH101LGB392MA80M		1,500	35×100	0.20	2.10	EKMH251LGB152MAA0M	
	4,700	35×100	0.12	5.00	EKMH101LGB472MAA0M		1,800	35×120	0.20	2.50	EKMH251LGB182MAC0M	
	5,600	35×100	0.12	5.40	EKMH101LGB562MAA0M		2,200	50×80	0.20	2.90	EKMH251LGC222MC80M	
	6,800	35×120	0.15	5.80	EKMH101LGB682MAC0M		2,700	50×100	0.20	3.50	EKMH251LGC272MCA0M	
	8,200	50×80	0.15	6.40	EKMH101LGC822MC80M		3,300	50×120	0.20	4.20	EKMH251LGC332MCC0M	
	10,000	50×100	0.15	7.80	EKMH101LGC103MCA0M		3,900	50×120	0.20	4.60	EKMH251LGC392MCC0M	
	12,000	50×120	0.15	9.30	EKMH101LGC123MCC0M		4,700	63.5×120	0.20	5.70	EKMH251LGC472MDC0M	
	15,000	50×120	0.15	10.4	EKMH101LGC153MCC0M		5,600	63.5×120	0.20	6.30	EKMH251LGC562MDC0M	
	18,000	63.5×100	0.20	10.4	EKMH101LGC183MDA0M		6,800	76.2×120	0.20	7.70	EKMH251LGC682MEC0M	
	22,000	63.5×120	0.20	12.5	EKMH101LGC223MDC0M		8,200	76.2×120	0.20	8.40	EKMH251LGC822MEC0M	
	27,000	76.2×120	0.25	13.7	EKMH101LGC273MEC0M		10,000	76.2×140	0.20	10.0	EKMH251LGC103MEE0M	
	33,000	76.2×120	0.25	15.2	EKMH101LGC333MEC0M		12,000	89×140	0.20	11.9	EKMH251LGC123MFE0M	
39,000	76.2×140	0.30	16.1	EKMH101LGC393MEE0M	315		180	35×50	0.10	0.80	EKMH315LGB181MA50M	
47,000	89×140	0.30	19.3	EKMH101LGC473MFE0M			220	35×50	0.10	0.90	EKMH315LGB221MA50M	
56,000	89×140	0.30	21.1	EKMH101LGC563MFE0M			270	35×50	0.10	1.00	EKMH315LGB271MA50M	
160	560	35×50	0.15	1.20			EKMH161LGB561MA50M	330	35×50	0.10	1.10	EKMH315LGB331MA50M
	680	35×50	0.15	1.30			EKMH161LGB681MA50M	390	35×50	0.10	1.20	EKMH315LGB391MA50M
	820	35×50	0.15	1.40			EKMH161LGB821MA50M	470	35×60	0.10	1.40	EKMH315LGB471MA60M
	1,000	35×50	0.15	1.60			EKMH161LGB102MA50M	560	35×60	0.10	1.50	EKMH315LGB561MA60M
	1,200	35×60	0.15	1.90			EKMH161LGB122MA60M	680	35×80	0.10	1.70	EKMH315LGB681MA80M
	1,500	35×60	0.15	2.10			EKMH161LGB152MA60M	820	35×80	0.15	1.70	EKMH315LGB821MA80M
	1,800	35×80	0.15	2.50			EKMH161LGB182MA80M	1,000	35×100	0.15	2.00	EKMH315LGB102MAA0M
	2,200	35×80	0.15	2.80			EKMH161LGB222MA80M	1,200	35×120	0.15	2.40	EKMH315LGB122MAC0M
	2,700	35×100	0.15	3.30			EKMH161LGB272MAA0M	1,500	50×80	0.15	2.70	EKMH315LGC152MC80M
	3,300	35×120	0.15	3.80			EKMH161LGB332MAC0M	1,800	50×100	0.15	3.30	EKMH315LGC182MCA0M
	3,900	50×80	0.20	3.80			EKMH161LGC392MC80M	2,200	50×120	0.15	4.00	EKMH315LGC222MCC0M
	4,700	50×100	0.20	4.60			EKMH161LGC472MCA0M	2,700	50×120	0.15	4.40	EKMH315LGC272MCC0M
	5,600	50×100	0.20	5.10			EKMH161LGC562MCA0M	3,300	63.5×100	0.15	5.10	EKMH315LGC332MDA0M
	6,800	50×120	0.20	6.10	EKMH161LGC682MCC0M		3,900	63.5×120	0.15	6.00	EKMH315LGC392MDC0M	
	8,200	63.5×100	0.20	7.00	EKMH161LGC822MDA0M		4,700	76.2×100	0.15	6.80	EKMH315LGC472MCA0M	
	10,000	63.5×120	0.20	8.40	EKMH161LGC103MDC0M		5,600	76.2×120	0.15	8.00	EKMH315LGC562MEC0M	
12,000	76.2×100	0.20	9.40	EKMH161LGC123MEA0M	6,800		76.2×130	0.15	9.20	EKMH315LGC682MED0M		
15,000	76.2×120	0.20	11.4	EKMH161LGC153MEC0M	8,200	89×140	0.15	11.4	EKMH315LGC822MFE0M			
18,000	76.2×140	0.20	13.4	EKMH161LGC183MEE0M	10,000	89×140	0.15	12.6	EKMH315LGC103MFE0M			
22,000	89×140	0.25	14.5	EKMH161LGC223MFE0M	350	180	35×50	0.10	0.80	EKMH351LGB181MA50M		
27,000	89×140	0.25	16.0	EKMH161LGC273MFE0M		220	35×50	0.10	0.90	EKMH351LGB221MA50M		
200	330	35×50	0.15	0.90		EKMH201LGB331MA50M	270	35×50	0.10	1.00	EKMH351LGB271MA50M	
	390	35×50	0.15	1.00		EKMH201LGB391MA50M	330	35×50	0.10	1.10	EKMH351LGB331MA50M	
	470	35×50	0.15	1.10		EKMH201LGB471MA50M	390	35×60	0.10	1.30	EKMH351LGB391MA60M	
	560	35×50	0.15	1.20		EKMH201LGB561MA50M	470	35×60	0.10	1.40	EKMH351LGB471MA60M	
	680	35×50	0.15	1.30		EKMH201LGB681MA50M	560	35×80	0.10	1.60	EKMH351LGB561MA80M	
	820	35×50	0.15	1.40		EKMH201LGB821MA50M	680	35×80	0.15	1.60	EKMH351LGB681MA80M	
	1,000	35×60	0.15	1.70		EKMH201LGB102MA60M	820	35×100	0.15	1.80	EKMH351LGB821MAA0M	
	1,200	35×60	0.15	1.90		EKMH201LGB122MA60M	1,000	35×120	0.15	2.20	EKMH351LGB102MAC0M	
	1,500	35×80	0.15	2.30		EKMH201LGB152MA80M	1,200	50×80	0.15	2.40	EKMH351LGC122MC80M	
	1,800	35×80	0.15	2.50		EKMH201LGB182MA80M	1,500	50×100	0.15	3.00	EKMH351LGC152MCA0M	
	2,200	35×100	0.15	3.00		EKMH201LGB222MAA0M	1,800	50×120	0.15	3.60	EKMH351LGC182MCC0M	
	2,700	35×120	0.15	3.60		EKMH201LGB272MAC0M	2,200	50×120	0.15	4.00	EKMH351LGC222MCC0M	
	3,300	50×80	0.15	4.10		EKMH201LGC332MC80M	2,700	63.5×100	0.15	4.60	EKMH351LGC272MDA0M	
	3,900	50×100	0.15	4.90		EKMH201LGC392MCA0M	3,900	76.2×120	0.15	6.70	EKMH351LGC392MEC0M	
	4,700	63.5×100	0.20	5.30	EKMH201LGC472MDA0M	5,600	76.2×130	0.15	8.30	EKMH351LGC562MED0M		
	5,600	63.5×100	0.20	5.80	EKMH201LGC562MDA0M	6,800	76.2×140	0.15	9.50	EKMH351LGC682MEE0M		
6,800	63.5×120	0.20	6.90	EKMH201LGC682MDC0M	8,200	89×140	0.15	11.4	EKMH351LGC822MFE0M			
8,200	63.5×120	0.20	7.60	EKMH201LGC822MDC0M	400	180	35×50	0.10	0.80	EKMH401LGB181MA50M		
10,000	76.2×120	0.20	9.30	EKMH201LGC103MEC0M		220	35×50	0.10	0.90	EKMH401LGB221MA50M		
12,000	76.2×120	0.20	10.2	EKMH201LGC123MEC0M		270	35×50	0.10	1.00	EKMH401LGB271MA50M		
15,000	76.2×140	0.20	12.2	EKMH201LGC153MEE0M		330	35×60	0.10	1.20	EKMH401LGB331MA60M		
18,000	89×140	0.25	13.1	EKMH201LGC183MFE0M		390	35×60	0.10	1.30	EKMH401LGB391MA60M		
250	270	35×50	0.15	0.80		EKMH251LGB271MA50M	470	35×80	0.10	1.40	EKMH401LGB471MA80M	

Product specifications in this catalog are subject to change without notice. Request our product specifications before purchase and/or use. Please use our products based on the information contained in this catalog and product specifications.



KMH Series

◆ **STANDARD RATINGS**

WV (Vdc)	Cap (μF)	Case size φD×L(mm)	tanδ	Rated ripple current (Arms/105°C,120Hz)	Part No.	WV (Vdc)	Cap (μF)	Case size φD×L(mm)	tanδ	Rated ripple current (Arms/105°C,120Hz)	Part No.
400	560	35×80	0.15	1.40	EKMH401LGB561MA80M	400	2,200	63.5×100	0.15	4.20	EKMH401LGC222MDA0M
	680	35×100	0.15	1.70	EKMH401LGB681MAA0M		3,300	63.5×120	0.15	5.50	EKMH401LGC332MDC0M
	820	35×120	0.15	2.00	EKMH401LGB821MAC0M		4,700	76.2×130	0.15	7.60	EKMH401LGC472MED0M
	1,000	50×80	0.15	2.20	EKMH401LGC102MC80M		5,600	89×140	0.15	9.40	EKMH401LGC562MFE0M
	1,200	50×100	0.15	2.70	EKMH401LGC122MCA0M		6,800	89×140	0.15	10.4	EKMH401LGC682MFE0M
	1,500	50×120	0.15	3.30	EKMH401LGC152MCC0M						

◆ **RATED RIPPLE CURRENT MULTIPLIERS**

● Frequency Multipliers

Rated voltage (Vdc)	Case diameter (mm)	Frequency (Hz)					
		50	120	300	1k	10k	50k
10 to 50	φ35 to φ89	0.95	1.00	1.03	1.05	1.09	1.12
	φ35	0.90	1.00	1.06	1.10	1.18	1.22
63 & 80	φ50 to φ89	0.95	1.00	1.03	1.05	1.09	1.12
	φ35	0.82	1.00	1.12	1.22	1.30	1.33
100	φ50	0.90	1.00	1.06	1.10	1.18	1.22
	φ63.5 to φ89	0.95	1.00	1.03	1.05	1.09	1.12
	φ35	0.80	1.00	1.19	1.34	1.46	1.52
160 to 250	φ50 & φ63.5	0.81	1.00	1.14	1.26	1.36	1.41
	φ76.2 & φ89	0.82	1.00	1.12	1.22	1.30	1.33
	φ35 to φ89	0.80	1.00	1.19	1.34	1.46	1.52

The endurance of capacitors is reduced with internal heating produced by ripple current at the rate of halving the lifetime with every 5°C rise. When long life performance is required in actual use, the rms ripple current has to be reduced.

New!

RWH Series

- Downsized and high ripple current from RWG series
- Endurance with ripple current : 5,000 hours at 85°C
- RoHS Compliant

RWH

↓
Downsized
↑
RWG



◆ SPECIFICATIONS

Items	Characteristics						
Category							
Temperature Range	-25 to +85°C						
Rated Voltage Range	350 to 450V _{dc}						
Capacitance Tolerance	±20% (M) (at 20°C, 120Hz)						
Leakage Current	I=0.02CV or 5mA, whichever is smaller. Where, I : Max. leakage current (μA), C : Nominal capacitance (μF), V : Rated voltage (V) (at 20°C after 5 minutes)						
Dissipation Factor (tanδ)	0.25 max. (at 20°C, 120Hz)						
Low Temperature Characteristics	Capacitance change $C(-25°C)/C(+20°C) \geq 0.7$ (at 120Hz)						
Insulation Resistance	When measured between the terminals that are connected to each other and to the mounting clamp on the insulating sleeve covering the case by using an insulation resistance meter of 500V _{dc} , the insulation resistance shall not be less than 100MΩ.						
Insulation Withstanding Voltage	When a voltage of 2,000Vac is applied for 1 minute between the terminals that are connected to each other and to the mounting clamp on the insulating sleeve covering the case, there shall not be electrical damage.						
Endurance	The following specifications shall be satisfied when the capacitors are restored to 20°C after subjected to DC voltage with the rated ripple current is applied (the peak voltage shall not exceed the rated voltage) for 5,000 hours at 85°C. <table border="1"> <tr> <td>Capacitance change</td> <td>≤±20% of the initial value</td> </tr> <tr> <td>D.F. (tanδ)</td> <td>≤200% of the initial specified value</td> </tr> <tr> <td>Leakage current</td> <td>≤The initial specified value</td> </tr> </table>	Capacitance change	≤±20% of the initial value	D.F. (tanδ)	≤200% of the initial specified value	Leakage current	≤The initial specified value
Capacitance change	≤±20% of the initial value						
D.F. (tanδ)	≤200% of the initial specified value						
Leakage current	≤The initial specified value						
Shelf Life	The following specifications shall be satisfied when the capacitors are restored to 20°C after exposing them for 500 hours at 85°C without voltage applied. Before the measurement, the capacitor shall be preconditioned by applying voltage according to Item 4.1 of JIS C 5101-4. <table border="1"> <tr> <td>Capacitance change</td> <td>≤±20% of the initial value</td> </tr> <tr> <td>D.F. (tanδ)</td> <td>≤200% of the initial specified value</td> </tr> <tr> <td>Leakage current</td> <td>≤The initial specified value</td> </tr> </table>	Capacitance change	≤±20% of the initial value	D.F. (tanδ)	≤200% of the initial specified value	Leakage current	≤The initial specified value
Capacitance change	≤±20% of the initial value						
D.F. (tanδ)	≤200% of the initial specified value						
Leakage current	≤The initial specified value						

◆ DIMENSIONS (Screw-Mount) [mm]

● Terminal Code : LG

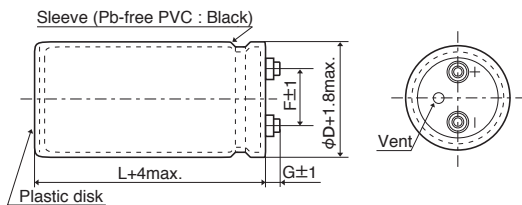

φ63.5, φ76.2 : G=6
φ89 : G=4

● Mounting Clamp Code : B

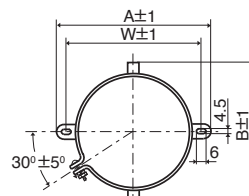

φD	A	B	W	F
63.5	90.0	76.0	80.0	28.0
76.2	104.5	90.0	93.5	31.5

● Mounting Clamp Code : C

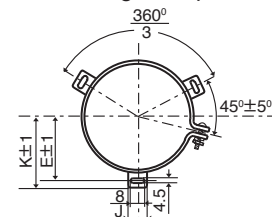

φD	E	K	F	J
63.5	38.1	43.5	28.0	14.0
76.2	44.5	50.0	31.5	14.0
89	50.8	56.5	31.5	16.0

<Screw specifications>

Plus hexagon-headed screw :M5×0.8×10

Maximum screw tightening torque :3.23Nm

* The screw and the mounting clamp are separately supplied and not attached to the product.

◆ PART NUMBERING SYSTEM

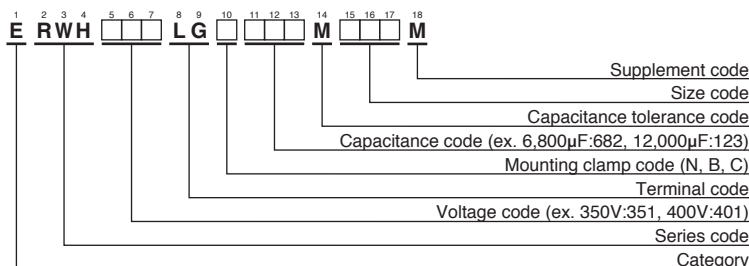

Please refer to "Product code guide (screw-mount terminal type)"

◆STANDARD RATINGS

WV (Vdc)	Cap (μF)	Case size φD×L(mm)	tanδ	Rated ripple current (Arms/85°C,120Hz)	Part No.	WV (Vdc)	Cap (μF)	Case size φD×L(mm)	tanδ	Rated ripple current (Arms/85°C,120Hz)	Part No.
350	4,700	63.5×105	0.25	16.3	ERWH351LGC472MDA5M	400	8,200	76.2×135	0.25	26.5	ERWH401LGC822MED5M
	5,600	63.5×125	0.25	19.2	ERWH351LGC562MDC5M		10,000	76.2×160	0.25	31.6	ERWH401LGC103MEG0M
	6,800	63.5×145	0.25	22.6	ERWH351LGC682MDE5M		10,000	89×130	0.25	28.3	ERWH401LGC103MFD0M
	6,800	76.2×105	0.25	21.7	ERWH351LGC682MEA5M		12,000	89×150	0.25	33.0	ERWH401LGC123MFF0M
	8,200	63.5×165	0.25	26.3	ERWH351LGC822MDG5M		15,000	89×180	0.25	39.9	ERWH401LGC153MFJ0M
	8,200	76.2×120	0.25	25.2	ERWH351LGC822MEC0M		450	3,300	63.5×105	0.25	13.6
	10,000	76.2×140	0.25	29.8	ERWH351LGC103MEE0M	3,900		63.5×125	0.25	16.0	ERWH451LGC392MDC5M
	12,000	76.2×165	0.25	35.1	ERWH351LGC123MEG5M	4,700		63.5×145	0.25	18.7	ERWH451LGC472MDE5M
	15,000	89×155	0.25	37.5	ERWH351LGC153MFF5M	4,700		76.2×105	0.25	18.0	ERWH451LGC472MEA5M
	18,000	89×180	0.25	43.8	ERWH351LGC183MFJ0M	5,600		63.5×165	0.25	21.7	ERWH451LGC562MDG5M
400	3,900	63.5×100	0.25	14.5	ERWH401LGC392MDA0M	5,600		76.2×120	0.25	20.8	ERWH451LGC562MEC0M
	4,700	63.5×120	0.25	17.2	ERWH401LGC472MDC0M	6,800		76.2×140	0.25	24.5	ERWH451LGC682MEE0M
	5,600	63.5×135	0.25	19.8	ERWH401LGC562MDD5M	8,200		76.2×165	0.25	29.0	ERWH451LGC822MEG5M
	5,600	76.2×105	0.25	19.7	ERWH401LGC562MEA5M	8,200		89×135	0.25	26.1	ERWH451LGC822MFD5M
	6,800	63.5×160	0.25	23.5	ERWH401LGC682MDG0M	10,000		89×155	0.25	30.5	ERWH451LGC103MFF5M
	6,800	76.2×115	0.25	22.5	ERWH401LGC682MEB5M	12,000	89×190	0.25	36.6	ERWH451LGC123MFK0M	

◆RATED RIPPLE CURRENT MULTIPLIERS

●Frequency Multipliers

Frequency (Hz)	50	120	300	1k	3k
Coefficient	0.8	1.0	1.1	1.3	1.4

Note : The endurance of capacitors is reduced with internal heating produced by ripple current at the rate of halving the lifetime with every 5 to 10°C rise. When long life performance is required in actual use, the rms ripple current has to be reduced. Also, for the RWH series capacitors, using them at operating voltage less than their rated voltage can extend their lifetime. For details, please contact a representative of Nippon Chemi-Con.



RWG Series

- Downsized, high ripple version of RWF series
- 20% better ripple current at 300Hz than RWF series
- Endurance with ripple current : 5,000 hours at 85°C
- RoHS Compliant

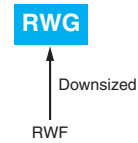

◆ SPECIFICATIONS

Items	Characteristics						
Category							
Temperature Range	-25 to +85°C						
Rated Voltage Range	350 to 450V _{dc}						
Capacitance Tolerance	±20% (M) (at 20°C, 120Hz)						
Leakage Current	I=0.02CV or 5mA, whichever is smaller. Where, I : Max. leakage current (µA), C : Nominal capacitance (µF), V : Rated voltage (V) (at 20°C after 5 minutes)						
Dissipation Factor (tanδ)	0.25 max. (at 20°C, 120Hz)						
Low Temperature Characteristics	Capacitance change $C(-25^{\circ}\text{C})/C(+20^{\circ}\text{C}) \geq 0.7$ (at 120Hz)						
Insulation Resistance	When measured between the terminals that are connected to each other and to the mounting clamp on the insulating sleeve covering the case by using an insulation resistance meter of 500V _{dc} , the insulation resistance shall not be less than 100MΩ.						
Insulation Withstanding Voltage	When a voltage of 2,000Vac is applied for 1 minute between the terminals that are connected to each other and to the mounting clamp on the insulating sleeve covering the case, there shall not be electrical damage.						
Endurance	The following specifications shall be satisfied when the capacitors are restored to 20°C after subjected to DC voltage with the rated ripple current is applied for (the peak voltage shall not exceed the rated voltage) 5,000 hours at 85°C. <table border="1" style="width: 100%;"> <tr> <td>Capacitance change</td> <td>≤±20% of the initial value</td> </tr> <tr> <td>D.F. (tanδ)</td> <td>≤200% of the initial specified value</td> </tr> <tr> <td>Leakage current</td> <td>≤The initial specified value</td> </tr> </table>	Capacitance change	≤±20% of the initial value	D.F. (tanδ)	≤200% of the initial specified value	Leakage current	≤The initial specified value
Capacitance change	≤±20% of the initial value						
D.F. (tanδ)	≤200% of the initial specified value						
Leakage current	≤The initial specified value						
Shelf Life	The following specifications shall be satisfied when the capacitors are restored to 20°C after exposing them for 500 hours at 85°C without voltage applied. Before the measurement, the capacitor shall be preconditioned by applying voltage according to Item 4.1 of JIS C 5101-4. <table border="1" style="width: 100%;"> <tr> <td>Capacitance change</td> <td>≤±20% of the initial value</td> </tr> <tr> <td>D.F. (tanδ)</td> <td>≤200% of the initial specified value</td> </tr> <tr> <td>Leakage current</td> <td>≤The initial specified value</td> </tr> </table>	Capacitance change	≤±20% of the initial value	D.F. (tanδ)	≤200% of the initial specified value	Leakage current	≤The initial specified value
Capacitance change	≤±20% of the initial value						
D.F. (tanδ)	≤200% of the initial specified value						
Leakage current	≤The initial specified value						

◆ DIMENSIONS (Screw-Mount) [mm]

● Terminal Code : LG

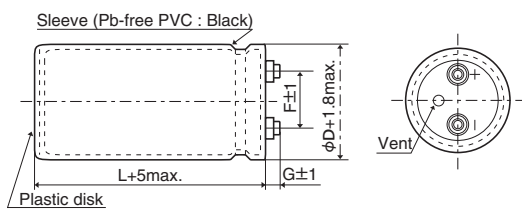

- φ50 : G=6
- φ63.5, φ76.2 : G=5
- φ89 : G=4

● Mounting Clamp Code : B

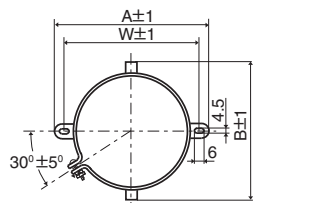

φD	A	B	W	F
50	78.0	64.0	68.0	22.4
63.5	90.0	76.0	80.0	28.0
76.2	104.5	90.0	93.5	31.5

● Mounting Clamp Code : C

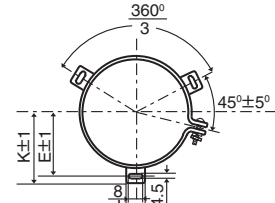

φD	E	K	F	J
50	32.5	37.0	22.4	14.0
63.5	38.1	43.5	28.0	14.0
76.2	44.5	50.0	31.5	14.0
89	50.8	56.5	31.5	16.0

<Screw specifications>

Plus hexagon-headed screw : M5×0.8×10

Maximum screw tightening torque : 3.23Nm

* The screw and the mounting clamp are separately supplied and not attached to the product.

◆ PART NUMBERING SYSTEM

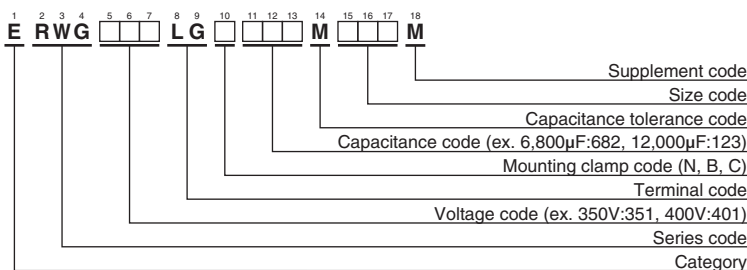

Please refer to "Product code guide (screw-mount terminal type)"

◆STANDARD RATINGS

WV (Vdc)	Cap (μF)	Case size φD×L(mm)	tan δ	Rated ripple current (Arms/85°C)		Part No.	WV (Vdc)	Cap (μF)	Case size φD×L(mm)	tan δ	Rated ripple current (Arms/85°C)		Part No.	
				120Hz	300Hz						120Hz	300Hz		
350	2,200	50 × 96	0.25	7.70	9.20	ERWG351LGC222MC96M	400	6,800	63.5 × 190	0.25	20.6	24.7	ERWG401LGC682MDK0M	
	2,700	50 × 105	0.25	8.90	10.6	ERWG351LGC272MCA5M		6,800	76.2 × 130	0.25	19.2	23.0	ERWG401LGC682MED0M	
	3,300	50 × 115	0.25	10.3	12.3	ERWG351LGC332MCB5M		8,200	76.2 × 155	0.25	22.7	27.2	ERWG401LGC822MEF5M	
	3,900	50 × 130	0.25	11.8	14.1	ERWG351LGC392MCD0M		10,000	76.2 × 170	0.25	26.2	31.4	ERWG401LGC103MEH0M	
	4,700	63.5 × 115	0.25	13.6	16.3	ERWG351LGC472MDB5M		12,000	89 × 155	0.25	30.0	36.0	ERWG401LGC123MFF5M	
	5,600	63.5 × 130	0.25	15.7	18.8	ERWG351LGC562MDD0M		12,000	89 × 170	0.25	31.3	37.5	ERWG401LGC123MFH0M	
	6,800	63.5 × 155	0.25	18.8	22.5	ERWG351LGC682MDF5M		15,000	89 × 190	0.25	36.7	44.0	ERWG401LGC153MFK0M	
	6,800	76.2 × 115	0.25	18.2	21.8	ERWG351LGC682MEB5M		450	1,500	50 × 96	0.25	6.40	7.60	ERWG451LGC152MC96M
	8,200	63.5 × 190	0.25	22.6	27.1	ERWG351LGC822MDK0M			1,800	50 × 105	0.25	7.30	8.70	ERWG451LGC182MCA5M
	8,200	76.2 × 130	0.25	21.0	25.2	ERWG351LGC822MED0M			2,200	50 × 115	0.25	8.40	10.0	ERWG451LGC222MCB5M
	10,000	76.2 × 155	0.25	25.1	30.1	ERWG351LGC103MEF5M			2,700	50 × 130	0.25	9.80	11.7	ERWG451LGC272MCD0M
	12,000	76.2 × 170	0.25	28.7	34.4	ERWG351LGC123MEH0M			3,300	63.5 × 115	0.25	11.4	13.6	ERWG451LGC332MDB5M
	15,000	89 × 155	0.25	33.6	40.3	ERWG351LGC153MFF5M			3,900	63.5 × 130	0.25	13.1	15.7	ERWG451LGC392MDD0M
	15,000	89 × 170	0.25	35.0	42.0	ERWG351LGC153MFH0M			4,700	63.5 × 155	0.25	15.6	18.7	ERWG451LGC472MDF5M
18,000	89 × 190	0.25	40.3	48.3	ERWG351LGC183MFK0M	4,700	76.2 × 115		0.25	15.1	18.1	ERWG451LGC472MEB5M		
400	1,800	50 × 96	0.25	7.00	8.40	ERWG401LGC182MC96M	5,600		63.5 × 190	0.25	18.7	22.4	ERWG451LGC562MDK0M	
	2,200	50 × 105	0.25	8.10	9.70	ERWG401LGC222MCA5M	5,600		76.2 × 130	0.25	17.4	20.8	ERWG451LGC562MED0M	
	2,700	50 × 115	0.25	9.30	11.1	ERWG401LGC272MCB5M	6,800		76.2 × 155	0.25	20.7	24.8	ERWG451LGC682MEF5M	
	3,300	50 × 130	0.25	10.9	13.0	ERWG401LGC332MCD0M	8,200		76.2 × 170	0.25	23.7	28.4	ERWG451LGC822MEH0M	
	3,900	63.5 × 115	0.25	12.4	14.8	ERWG401LGC392MDB5M	10,000		89 × 155	0.25	27.4	32.8	ERWG451LGC103MFF5M	
	4,700	63.5 × 130	0.25	14.4	17.2	ERWG401LGC472MDD0M	10,000		89 × 170	0.25	28.6	34.3	ERWG451LGC103MFH0M	
	5,600	63.5 × 155	0.25	17.0	20.4	ERWG401LGC562MDF5M	12,000	89 × 190	0.25	32.9	39.4	ERWG451LGC123MFK0M		
	5,600	76.2 × 115	0.25	16.5	19.8	ERWG401LGC562MEB5M								

◆RATED RIPPLE CURRENT MULTIPLIERS

●Frequency Multipliers

Frequency (Hz)	50	120	300	1k	3k
Coefficient	0.8	1.0	1.2	1.4	1.5

Note : The endurance of capacitors is reduced with internal heating produced by ripple current at the rate of halving the lifetime with every 5 to 10°C rise. When long life performance is required in actual use, the rms ripple current has to be reduced. Also, for the RWG series capacitors, using them at operating voltage less than their rated voltage can extend their lifetime. For details, please contact a representative of Nippon Chemi-Con.

RWF Series

- High ripple capability
- Endurance with ripple current : 5,000 hours at 85°C
- Wide range of case sizes from $\phi 50$ to $\phi 100$
- RoHS Compliant

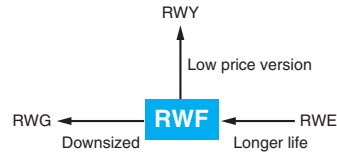

◆ SPECIFICATIONS

Items	Characteristics
Category	
Temperature Range	-25 to +85°C
Rated Voltage Range	350 to 450V _{dc}
Capacitance Tolerance	±20% (M) (at 20°C, 120Hz)
Leakage Current	I=0.02CV or 5mA, whichever is smaller. Where, I : Max. leakage current (μA), C : Nominal capacitance (μF), V : Rated voltage (V) (at 20°C after 5 minutes)
Dissipation Factor (tanδ)	0.25 max. (at 20°C, 120Hz)
Low Temperature Characteristics	Capacitance change $C(-25°C)/C(+20°C) \geq 0.7$ (at 120Hz)
Insulation Resistance	When measured between the terminals that are connected to each other and to the mounting clamp on the insulating sleeve covering the case by using an insulation resistance meter of 500V _{dc} , the insulation resistance shall not be less than 100MΩ.
Insulation Withstanding Voltage	When a voltage of 2,000V _{ac} is applied for 1 minute between the terminals that are connected to each other and to the mounting clamp on the insulating sleeve covering the case, there shall not be electrical damage.
Endurance	The following specifications shall be satisfied when the capacitors are restored to 20°C after subjected to DC voltage with the rated ripple current is applied (the peak voltage shall not exceed the rated voltage) for 5,000 hours at 85°C.
	Capacitance change $\leq \pm 20\%$ of the initial value
	D.F. (tanδ) $\leq 200\%$ of the initial specified value
	Leakage current \leq The initial specified value
Shelf Life	The following specifications shall be satisfied when the capacitors are restored to 20°C after exposing them for 500 hours at 85°C without voltage applied. Before the measurement, the capacitor shall be preconditioned by applying voltage according to Item 4.1 of JIS C 5101-4.
	Capacitance change $\leq \pm 20\%$ of the initial value
	D.F. (tanδ) $\leq 200\%$ of the initial specified value
	Leakage current \leq The initial specified value

◆ DIMENSIONS (Screw-Mount) [mm]

● Terminal Code : LG

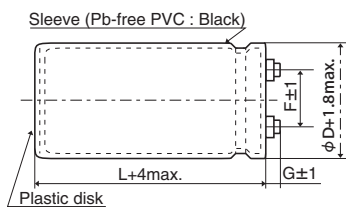

$\phi 50$ & $\phi 63.5$: G=6
 $\phi 76.2$ & $\phi 89$: G=5
 $\phi 100$: G=10

<Screw specifications>

to $\phi 89$ Plus hexagon-headed screw : M5×0.8×10
 Maximum screw tightening torque : 3.23Nm

● Mounting Clamp Code : B

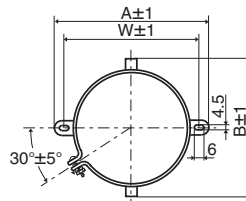

φD	A	B	W	F
50	78.0	64.0	68.0	22.4
63.5	90.0	76.0	80.0	28.0
76.2	104.5	90.0	93.5	31.5

● Mounting Clamp Code : C

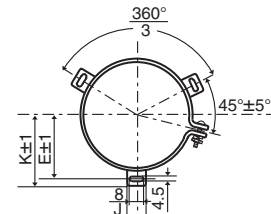

φD	E	K	F	J
50	32.5	37.0	22.4	14.0
63.5	38.1	43.5	28.0	14.0
76.2	44.5	50.0	31.5	14.0
89	50.8	56.5	31.5	16.0
100	56.5	63.4	41.5	18.0

$\phi 100$ Cross-recessed head (Phillips) screw : M8×1.25×16
 Spring washer, Washer
 Maximum screw tightening torque : 6.31Nm

* The screw and the mounting clamp are separately supplied and not attached to the product.

◆ PART NUMBERING SYSTEM

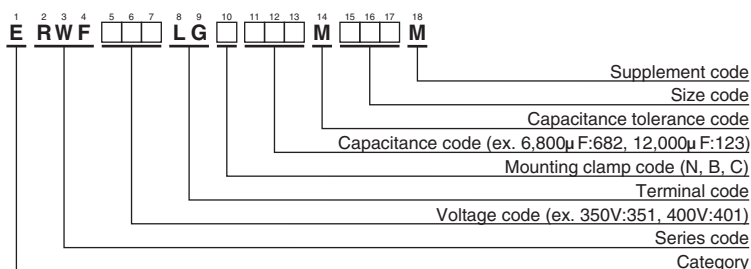

Please refer to "Product code guide (screw-mount terminal type)"

◆STANDARD RATINGS

WV (Vdc)	Cap (μF)	Case size φD×L(mm)	tanδ	Rated ripple current (Arms/85°C,120Hz)	Part No.	WV (Vdc)	Cap (μF)	Case size φD×L(mm)	tanδ	Rated ripple current (Arms/85°C,120Hz)	Part No.	
350	1,200	50×60	0.25	4.90	ERWF351LGC122MC60M	400	5,600	63.5×190	0.25	18.2	ERWF401LGC562MDK0M	
	1,800	50×75	0.25	6.50	ERWF351LGC182MC75M		5,600	76.2×130	0.25	16.9	ERWF401LGC562MED0M	
	2,200	50×85	0.25	7.50	ERWF351LGC222MC85M		6,800	76.2×155	0.25	20.2	ERWF401LGC682MEF5M	
	2,200	50×96	0.25	7.70	ERWF351LGC222MC96M		8,200	76.2×170	0.25	22.8	ERWF401LGC822MEH0M	
	2,700	50×115	0.25	9.30	ERWF351LGC272MCB5M		10,000	89×155	0.25	26.6	ERWF401LGC103MFF5M	
	3,300	50×130	0.25	10.8	ERWF351LGC332MCD0M		12,000	89×170	0.25	30.0	ERWF401LGC123MFH0M	
	3,900	63.5×115	0.25	12.1	ERWF351LGC392MDB5M		15,000	100×190	0.25	33.7	ERWF401LGC153MGK0M	
	4,700	63.5×130	0.25	14.0	ERWF351LGC472MDD0M		18,000	100×220	0.25	37.4	ERWF401LGC183MGN0M	
	5,600	63.5×155	0.25	16.6	ERWF351LGC562MDF5M		450	820	50×60	0.25	4.00	ERWF451LGC821MC60M
	5,600	76.2×115	0.25	16.1	ERWF351LGC562MEB5M			1,000	50×75	0.25	4.80	ERWF451LGC102MC75M
	6,800	63.5×190	0.25	20.0	ERWF351LGC682MDK0M			1,200	50×85	0.25	5.60	ERWF451LGC122MC85M
	6,800	76.2×130	0.25	18.6	ERWF351LGC682MED0M			1,200	50×96	0.25	5.70	ERWF451LGC122MC96M
	8,200	76.2×155	0.25	22.2	ERWF351LGC822MEF5M			1,500	50×96	0.25	6.30	ERWF451LGC152MC96M
	10,000	76.2×170	0.25	25.2	ERWF351LGC103MEH0M			1,800	50×115	0.25	7.60	ERWF451LGC182MCB5M
12,000	89×155	0.25	29.1	ERWF351LGC123MFF5M	2,200	50×130		0.25	8.80	ERWF451LGC222MCD0M		
15,000	89×190	0.25	35.7	ERWF351LGC153MFK0M	2,700	63.5×115		0.25	10.1	ERWF451LGC272MDB5M		
18,000	100×190	0.25	36.9	ERWF351LGC183MGK0M	3,300	63.5×130		0.25	11.7	ERWF451LGC332MDD0M		
22,000	100×250	0.25	46.1	ERWF351LGC223MGR0M	3,900	63.5×155		0.25	13.8	ERWF451LGC392MDF5M		
400	1,000	50×60	0.25	4.40	ERWF401LGC102MC60M	3,900		76.2×115	0.25	13.4	ERWF451LGC392MEB5M	
	1,500	50×75	0.25	5.90	ERWF401LGC152MC75M	4,700		63.5×190	0.25	16.7	ERWF451LGC472MDK0M	
	1,800	50×85	0.25	6.80	ERWF401LGC182MC85M	4,700		76.2×130	0.25	15.5	ERWF451LGC472MED0M	
	1,800	50×96	0.25	7.00	ERWF401LGC182MC96M	5,600		76.2×155	0.25	18.3	ERWF451LGC562MEF5M	
	2,200	50×105	0.25	8.00	ERWF401LGC222MCA5M	6,800	76.2×170	0.25	20.7	ERWF451LGC682MEH0M		
	2,700	50×130	0.25	9.80	ERWF401LGC272MCD0M	8,200	89×155	0.25	24.1	ERWF451LGC822MFF5M		
	3,300	63.5×115	0.25	11.1	ERWF401LGC332MDB5M	10,000	89×170	0.25	27.8	ERWF451LGC103MFH0M		
	3,900	63.5×130	0.25	12.7	ERWF401LGC392MDD0M	12,000	100×190	0.25	29.3	ERWF451LGC123MGK0M		
	4,700	63.5×155	0.25	15.2	ERWF401LGC472MDF5M	15,000	100×250	0.25	37.0	ERWF451LGC153MGR0M		
	4,700	76.2×115	0.25	14.7	ERWF401LGC472MEB5M							

◆RATED RIPPLE CURRENT MULTIPLIERS
●Frequency Multipliers

Frequency (Hz)	50	120	300	1k	3k
Coefficient	0.8	1.0	1.1	1.3	1.4

Note : The endurance of capacitors is reduced with internal heating produced by ripple current at the rate of halving the lifetime with every 5 to 10°C rise. When long life performance is required in actual use, the rms ripple current has to be reduced. Also, for the RWF series capacitors, using them at operating voltage less than their rated voltage can extend their lifetime. For details, please contact a representative of Nippon Chemi-Con.

New!

RWR Series

- Downsized and high ripple current from RWQ series
- Endurance with ripple current : 2,000 hours at 85°C
- RoHS Compliant

RWR

↑ Downsized
RWQ



◆ SPECIFICATIONS

Items	Characteristics						
Category							
Temperature Range	-25 to +85°C						
Rated Voltage Range	350 to 450V _{dc}						
Capacitance Tolerance	±20% (M) (at 20°C, 120Hz)						
Leakage Current	I=0.02CV or 5mA, whichever is smaller. Where, I : Max. leakage current (μA), C : Nominal capacitance (μF), V : Rated voltage (V) (at 20°C after 5 minutes)						
Dissipation Factor (tanδ)	0.25 max. (at 20°C, 120Hz)						
Low Temperature Characteristics	Capacitance change $C(-25°C)/C(+20°C) \geq 0.7$ (at 120Hz)						
Insulation Resistance	When measured between the terminals that are connected to each other and to the mounting clamp on the insulating sleeve covering the case by using an insulation resistance meter of 500V _{dc} , the insulation resistance shall not be less than 100MΩ.						
Insulation Withstanding Voltage	When a voltage of 2,000Vac is applied for 1 minute between the terminals that are connected to each other and to the mounting clamp on the insulating sleeve covering the case, there shall not be electrical damage.						
Endurance	The following specifications shall be satisfied when the capacitors are restored to 20°C after subjected to DC voltage with the rated ripple current is applied (the peak voltage shall not exceed the rated voltage) for 2,000 hours at 85°C. <table border="1" style="width: 100%;"> <tr> <td>Capacitance change</td> <td>≤±20% of the initial value</td> </tr> <tr> <td>D.F. (tanδ)</td> <td>≤300% of the initial specified value</td> </tr> <tr> <td>Leakage current</td> <td>≤The initial specified value</td> </tr> </table>	Capacitance change	≤±20% of the initial value	D.F. (tanδ)	≤300% of the initial specified value	Leakage current	≤The initial specified value
Capacitance change	≤±20% of the initial value						
D.F. (tanδ)	≤300% of the initial specified value						
Leakage current	≤The initial specified value						
Shelf Life	The following specifications shall be satisfied when the capacitors are restored to 20°C after exposing them for 500 hours at 85°C without voltage applied. Before the measurement, the capacitor shall be preconditioned by applying voltage according to Item 4.1 of JIS C 5101-4. <table border="1" style="width: 100%;"> <tr> <td>Capacitance change</td> <td>≤±20% of the initial value</td> </tr> <tr> <td>D.F. (tanδ)</td> <td>≤300% of the initial specified value</td> </tr> <tr> <td>Leakage current</td> <td>≤The initial specified value</td> </tr> </table>	Capacitance change	≤±20% of the initial value	D.F. (tanδ)	≤300% of the initial specified value	Leakage current	≤The initial specified value
Capacitance change	≤±20% of the initial value						
D.F. (tanδ)	≤300% of the initial specified value						
Leakage current	≤The initial specified value						

◆ DIMENSIONS (Screw-Mount) [mm]

● Terminal Code : LG

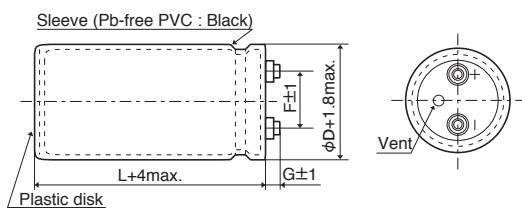

φ63.5, φ76.2 : G=6
φ89 : G=4

● Mounting Clamp Code : B

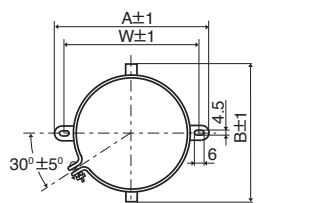

φD	A	B	W	F
63.5	90.0	76.0	80.0	28.0
76.2	104.5	90.0	93.5	31.5

● Mounting Clamp Code : C

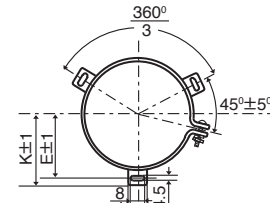

φD	E	K	F	J
63.5	38.1	43.5	28.0	14.0
76.2	44.5	50.0	31.5	14.0
89	50.8	56.5	31.5	16.0

<Screw specifications>

Plus hexagon-headed screw :M5×0.8×10

Maximum screw tightening torque :3.23Nm

* The screw and the mounting clamp are separately supplied and not attached to the product.

◆ PART NUMBERING SYSTEM

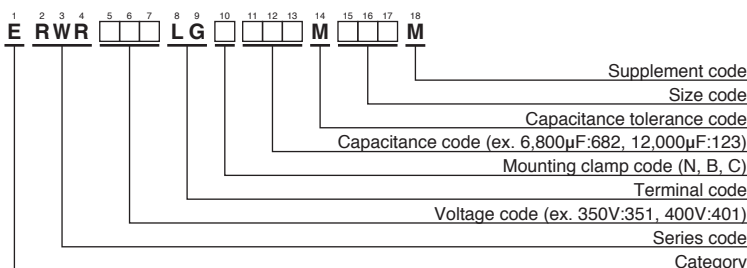

Please refer to "Product code guide (screw-mount terminal type)"

◆STANDARD RATINGS

WV (Vdc)	Cap (μF)	Case size φD×L(mm)	tan δ	Rated ripple current (Arms/85°C,120Hz)	Part No.	WV (Vdc)	Cap (μF)	Case size φD×L(mm)	tan δ	Rated ripple current (Arms/85°C,120Hz)	Part No.	
350	3,900	63.5×100	0.25	13.7	ERWR351LGC392MDA0M	400	6,800	76.2×110	0.25	20.9	ERWR401LGC682MEB0M	
	4,700	63.5×100	0.25	15.1	ERWR351LGC472MDA0M		8,200	76.2×130	0.25	24.7	ERWR401LGC822MED0M	
	5,600	63.5×115	0.25	17.5	ERWR351LGC562MDB5M		10,000	89×125	0.25	26.4	ERWR401LGC103MFC5M	
	5,600	76.2×100	0.25	18.2	ERWR351LGC562MEA0M		12,000	89×145	0.25	30.8	ERWR401LGC123MFE5M	
	6,800	76.2×100	0.25	20.1	ERWR351LGC682MEA0M		450	2,700	63.5×100	0.25	11.4	ERWR451LGC272MDA0M
	8,200	76.2×115	0.25	23.4	ERWR351LGC822MEB5M			3,300	63.5×105	0.25	12.9	ERWR451LGC332MDA5M
	10,000	76.2×135	0.25	27.7	ERWR351LGC103MED5M			3,900	63.5×115	0.25	14.6	ERWR451LGC392MDB5M
	12,000	89×125	0.25	28.9	ERWR351LGC123MFC5M			3,900	76.2×100	0.25	15.2	ERWR451LGC392MEA0M
	15,000	89×150	0.25	34.9	ERWR351LGC153MFF0M			4,700	63.5×135	0.25	17.2	ERWR451LGC472MDD5M
400	3,300	63.5×100	0.25	12.6	ERWR401LGC332MDA0M	4,700		76.2×105	0.25	17.0	ERWR451LGC472MEA5M	
	3,900	63.5×100	0.25	13.7	ERWR401LGC392MDA0M	5,600		76.2×115	0.25	19.3	ERWR451LGC562MEB5M	
	4,700	63.5×115	0.25	16.0	ERWR401LGC472MDB5M	6,800		76.2×135	0.25	22.8	ERWR451LGC682MED5M	
	4,700	76.2×100	0.25	16.7	ERWR401LGC472MEA0M	8,200		89×125	0.25	23.9	ERWR451LGC822MFC5M	
	5,600	63.5×130	0.25	18.4	ERWR401LGC562MDD0M	10,000	89×150	0.25	28.5	ERWR451LGC103MFF0M		

◆RATED RIPPLE CURRENT MULTIPLIERS

●Frequency Multipliers

Frequency (Hz)	50	120	300	1k	3k
Coefficient	0.8	1.0	1.1	1.3	1.4

Note : The endurance of capacitors is reduced with internal heating produced by ripple current at the rate of halving the lifetime with every 5 to 10°C rise. When long life performance is required in actual use, the rms ripple current has to be reduced. Also, for the RWR series capacitors, using them at operating voltage less than their rated voltage can extend their lifetime. For details, please contact a representative of Nippon Chemi-Con.

RWQ Series

- Downsized and high ripple current from RWE series
- Endurance with ripple current : 2,000 hours at 85°C
- RoHS Compliant

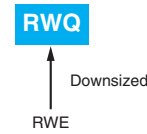

◆SPECIFICATIONS

Items	Characteristics		
Category	-25 to +85°C		
Temperature Range	-25 to +85°C		
Rated Voltage Range	350 to 550V _{dc}		
Capacitance Tolerance	±20% (M) (at 20°C, 120Hz)		
Leakage Current	I=0.02CV or 5mA, whichever is smaller. Where, I : Max. leakage current (μA), C : Nominal capacitance (μF), V : Rated voltage (V _{dc}) (at 20°C after 5 minutes)		
Dissipation Factor (tanδ)	0.25 max. (at 20°C, 120Hz)		
Low Temperature Characteristics	Rated voltage (V _{dc})	350 to 450V	500 to 550V
	C(-25°C) / C(+20°C)	≥0.7	≥0.6
Insulation Resistance	When measured between the terminals shorted each other and the mounting clamp on the insulating sleeve covering the case by using an insulation resistance meter of 500V _{dc} , the insulation resistance shall not be less than 100MΩ. (at 120Hz)		
Insulation Withstanding Voltage	When a voltage of 2,000V _{ac} is applied for 1 minute between the terminals shorted each other and the mounting clamp on the insulating sleeve covering the case, there shall not be electrical damage.		
Endurance	The following specifications shall be satisfied when the capacitors are restored to 20°C after subjected to DC voltage with the rated ripple current is applied (the peak voltage shall not exceed the rated voltage) for 2,000 hours at 85°C.		
	Capacitance change	≤±20% of the initial value	
	D.F. (tanδ)	≤300% of the initial specified value	
	Leakage current	≤The initial specified value	
Shelf Life	The following specifications shall be satisfied when the capacitors are restored to 20°C after exposing them for 500 hours at 85°C without voltage applied. Before the measurement, the capacitor shall be preconditioned by applying voltage according to Item 4.1 of JISC 5101-4.		
	Capacitance change	≤±20% of the initial value	
	D.F. (tanδ)	≤300% of the initial specified value	
	Leakage current	≤The initial specified value	

◆DIMENSIONS (Screw-Mount) [mm]

● Terminal Code : LG

● Mounting Clamp Code : B

● Mounting Clamp Code : C

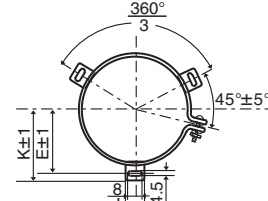
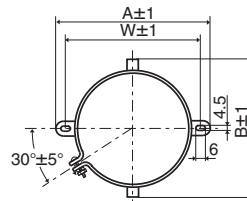
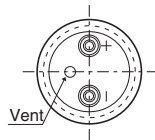
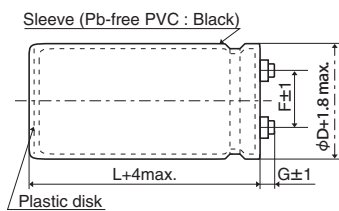

φD	A	B	W	F
50	78.0	64.0	68.0	22.4
63.5	90.0	76.0	80.0	28.0
76.2	104.5	90.0	93.5	31.5

φD	E	K	F	J
50	32.5	37.0	22.4	14.0
63.5	38.1	43.5	28.0	14.0
76.2	44.5	50.0	31.5	14.0
89	50.8	56.5	31.5	16.0

φ50 & φ63.5 : G=6

φ76.2 & φ89 : G=5

<Screw specifications>

Plus hexagon-headed screw : M5×0.8×10

Maximum screw tightening torque : 3.23Nm

* The screw and the mounting clamp are separately supplied and not attached to the product.

◆PART NUMBERING SYSTEM

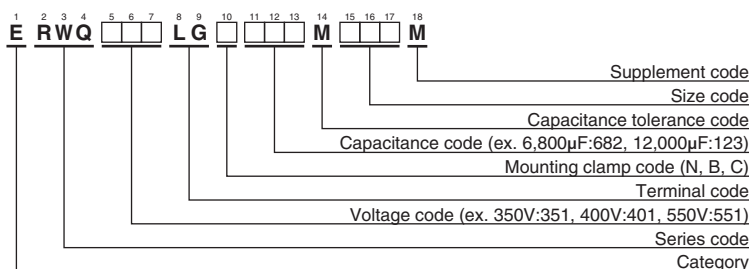

Please refer to "Product code guide (screw-mount terminal type)"

◆STANDARD RATINGS

WV (Vdc)	Cap (μF)	Case size φD×L(mm)	tanδ	Rated ripple current (Arms/85°C,120Hz)	Part No.	WV (Vdc)	Cap (μF)	Case size φD×L(mm)	tanδ	Rated ripple current (Arms/85°C,120Hz)	Part No.
350	1,500	50 × 65	0.25	5.09	ERWQ351LGC152MC65M	500	470	50 × 60	0.25	2.17	ERWQ501LGC471MC60M
	1,800	50 × 75	0.25	5.93	ERWQ351LGC182MC75M		680	50 × 65	0.25	2.70	ERWQ501LGC681MC65M
	2,200	50 × 96	0.25	7.30	ERWQ351LGC222MC96M		820	50 × 75	0.25	3.15	ERWQ501LGC821MC75M
	2,700	50 × 115	0.25	8.76	ERWQ351LGC272MCB5M		1,000	50 × 85	0.25	3.67	ERWQ501LGC102MC85M
	3,300	63.5 × 85	0.25	9.71	ERWQ351LGC332MD85M		1,200	50 × 96	0.25	4.22	ERWQ501LGC122MC96M
	3,900	50 × 130	0.25	11.1	ERWQ351LGC392MCD0M		1,500	50 × 115	0.25	5.14	ERWQ501LGC152MCB5M
	3,900	63.5 × 96	0.25	11.1	ERWQ351LGC392MD96M		1,500	63.5 × 96	0.25	5.42	ERWQ501LGC152MD96M
	4,700	63.5 × 115	0.25	13.2	ERWQ351LGC472MDB5M		1,800	50 × 130	0.25	5.95	ERWQ501LGC182MCD0M
	5,600	63.5 × 130	0.25	15.2	ERWQ351LGC562MDD0M		1,800	63.5 × 96	0.25	5.94	ERWQ501LGC182MD96M
	5,600	76.2 × 96	0.25	14.3	ERWQ351LGC562ME96M		2,200	63.5 × 115	0.25	7.10	ERWQ501LGC222MDB5M
	6,800	76.2 × 115	0.25	17.0	ERWQ351LGC682MEB5M		2,200	76.2 × 96	0.25	7.30	ERWQ501LGC222ME96M
	8,200	76.2 × 130	0.25	19.6	ERWQ351LGC822MED0M		2,700	63.5 × 130	0.25	8.31	ERWQ501LGC272MDD0M
	10,000	76.2 × 155	0.25	23.4	ERWQ351LGC103MEF5M		3,300	76.2 × 115	0.25	9.65	ERWQ501LGC332MEB5M
	12,000	89 × 130	0.25	24.1	ERWQ351LGC123MFD0M		3,900	76.2 × 130	0.25	11.1	ERWQ501LGC392MED0M
15,000	89 × 155	0.25	29.1	ERWQ351LGC153MFF5M	4,700	76.2 × 155	0.25	13.1	ERWQ501LGC472MEF5M		
400	1,200	50 × 65	0.25	4.55	ERWQ401LGC122MC65M	6,800	89 × 155	0.25	15.9	ERWQ501LGC682MFF5M	
	1,500	50 × 75	0.25	5.41	ERWQ401LGC152MC75M	550	390	50 × 60	0.25	1.98	ERWQ551LGC391MC60M
	1,800	50 × 85	0.25	6.26	ERWQ401LGC182MC85M		560	50 × 65	0.25	2.45	ERWQ551LGC561MC65M
	2,200	50 × 96	0.25	7.30	ERWQ401LGC222MC96M		680	50 × 75	0.25	2.87	ERWQ551LGC681MC75M
	2,700	50 × 115	0.25	8.76	ERWQ401LGC272MCB5M		820	50 × 85	0.25	3.32	ERWQ551LGC821MC85M
	3,300	63.5 × 96	0.25	10.2	ERWQ401LGC332MD96M		1,200	50 × 115	0.25	4.60	ERWQ551LGC122MCB5M
	3,900	63.5 × 115	0.25	12.0	ERWQ401LGC392MDB5M		1,500	63.5 × 96	0.25	5.42	ERWQ551LGC152MD96M
	4,700	63.5 × 130	0.25	13.9	ERWQ401LGC472MDD0M		1,800	76.2 × 80	0.25	6.12	ERWQ551LGC182ME80M
	4,700	76.2 × 96	0.25	13.1	ERWQ401LGC472ME96M		2,200	76.2 × 96	0.25	7.30	ERWQ551LGC222ME96M
	5,600	63.5 × 155	0.25	16.5	ERWQ401LGC562MDF5M		2,700	76.2 × 115	0.25	8.73	ERWQ551LGC272MEB5M
	6,800	76.2 × 115	0.25	17.0	ERWQ401LGC682MEB5M		3,300	76.2 × 130	0.25	10.2	ERWQ551LGC332MED0M
	8,200	76.2 × 155	0.25	21.2	ERWQ401LGC822MEF5M		5,600	89 × 155	0.25	14.5	ERWQ551LGC562MFF5M
	10,000	89 × 130	0.25	22.0	ERWQ401LGC103MFD0M						
	12,000	89 × 155	0.25	26.0	ERWQ401LGC123MFF5M						
450	1,000	50 × 70	0.25	3.87	ERWQ451LGC102MC70M						
	1,200	50 × 75	0.25	4.36	ERWQ451LGC122MC75M						
	1,500	50 × 90	0.25	5.28	ERWQ451LGC152MC90M						
	1,800	50 × 96	0.25	5.95	ERWQ451LGC182MC96M						
	2,200	50 × 130	0.25	7.54	ERWQ451LGC222MCD0M						
	2,700	63.5 × 96	0.25	8.34	ERWQ451LGC272MD96M						
	3,300	63.5 × 115	0.25	9.97	ERWQ451LGC332MDB5M						
	3,900	63.5 × 130	0.25	11.4	ERWQ451LGC392MDD0M						
	3,900	76.2 × 96	0.25	11.1	ERWQ451LGC392ME96M						
	4,700	63.5 × 155	0.25	13.6	ERWQ451LGC472MDF5M						
	4,700	76.2 × 115	0.25	13.2	ERWQ451LGC472MEB5M						
	5,600	76.2 × 130	0.25	15.2	ERWQ451LGC562MED0M						
	6,800	76.2 × 155	0.25	18.1	ERWQ451LGC682MEF5M						
	8,200	89 × 130	0.25	19.2	ERWQ451LGC822MFD0M						

◆RATED RIPPLE CURRENT MULTIPLIERS
●Frequency Multipliers

Frequency (Hz)	50	120	300	1k	3k
Coefficient	0.8	1.0	1.1	1.3	1.4

Note : The endurance of capacitors is shorted with internal heating produced by ripple current at the rate of halving the lifetime with every 5 to 10°C rise. When long life performance is required in actual use, the rms ripple current has to be reduced. Also, for the RWQ series capacitors, using them at operating voltage less than their rated voltage can extend their lifetime. For the details, please contact a representative of Nippon Chemi-Con.

RWE Series

- Rated voltage range : 350 to 550V_{dc}
- Endurance with ripple current : 85°C 2,000 hours
- RoHS Compliant

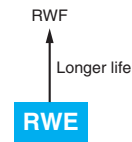

◆ SPECIFICATIONS

Items	Characteristics			
Category	-25 to +85°C			
Temperature Range	-25 to +85°C			
Rated Voltage Range	350 to 550V _{dc}			
Capacitance Tolerance	±20% (M) (at 20°C, 120Hz)			
Leakage Current	I=0.02CV or 5mA, whichever is smaller. Where, I : Max. leakage current (μA), C : Nominal capacitance (μF), V : Rated voltage (V) (at 20°C after 5 minutes)			
Dissipation Factor (tanδ)	0.25 max. (at 20°C, 120Hz)			
Low Temperature Characteristics	Capacitance change	Rated Voltage (V _{dc})	350 to 450V	500 & 550V
		C(-25°C)/C(+20°C)	≥0.7	≥0.6
Insulation Resistance	When measured between the terminals that are connected to each other and to the mounting clamp on the insulating sleeve covering the case by using an insulation resistance meter of 500V _{dc} , the insulation resistance shall not be less than 100MΩ.			
Insulation Withstanding Voltage	When a voltage of 2,000Vac is applied for 1 minute between the terminals that are connected to each other and to the mounting clamp on the insulating sleeve covering the case, there shall not be electrical damage.			
Endurance	The following specifications shall be satisfied when the capacitors are restored to 20°C after subjected to DC voltage with the rated ripple current is applied (the peak voltage shall not exceed the rated voltage) for 2,000 hours at 85°C.			
	Capacitance change	≤±20% of the initial value		
	D.F. (tanδ)	≤300% of the initial specified value		
	Leakage current	≤The initial specified value		
Shelf Life	The following specifications shall be satisfied when the capacitors are restored to 20°C after exposing them for 500 hours at 85°C without voltage applied. Before the measurement, the capacitor shall be preconditioned by applying voltage according to Item 4.1 of JIS C 5101-4.			
	Capacitance change	≤±20% of the initial value		
	D.F. (tanδ)	≤300% of the initial specified value		
	Leakage current	≤The initial specified value		

◆ DIMENSIONS (Screw-Mount) [mm]

● Terminal Code : LG

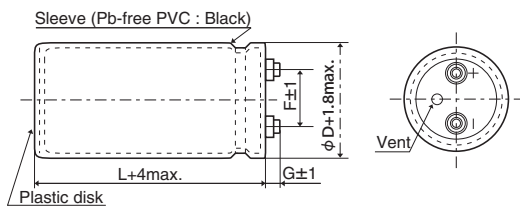

φ35 to φ63.5 : G=6
φ76.2 & φ89 : G=5

● Mounting Clamp Code : B

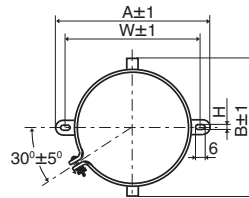

φD	A	B	W	H	F
35	58.0	44.0	48.0	3.5	12.7
50	78.0	64.0	68.0	4.5	22.4
63.5	90.0	76.0	80.0	4.5	28.0
76.2	104.5	90.0	93.5	4.5	31.5

● Mounting Clamp Code : C

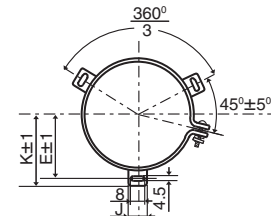

φD	E	K	F	J
50	32.5	37.0	22.4	14.0
63.5	38.1	43.5	28.0	14.0
76.2	44.5	50.0	31.5	14.0
89	50.8	56.5	31.5	16.0

<Screw specifications>

Plus hexagon-headed screw :M5×0.8×10
Maximum screw tightening torque :3.23Nm

* The screw and the mounting clamp are separately supplied and not attached to the product.

◆ PART NUMBERING SYSTEM

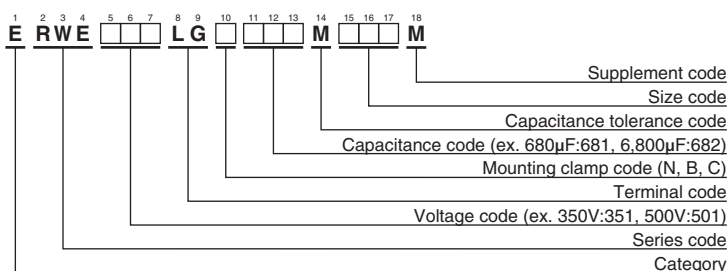

Please refer to "Product code guide (screw-mount terminal type)"

◆STANDARD RATINGS

WV (Vdc)	Cap (μF)	Case size φD×L(mm)	tanδ	Rated ripple current (Arms/85°C,120Hz)	Part No.	WV (Vdc)	Cap (μF)	Case size φD×L(mm)	tanδ	Rated ripple current (Arms/85°C,120Hz)	Part No.	
350	390	35×50	0.25	1.90	ERWE351LGB391MA50M	450	2,700	63.5×115	0.25	8.60	ERWE451LGC272MDB5M	
	680	35×80	0.25	2.90	ERWE351LGB681MA80M		3,300	63.5×130	0.25	10.0	ERWE451LGC332MDD0M	
	1,000	35×100	0.25	3.80	ERWE351LGB102MAA0M		3,300	76.2×96	0.25	9.80	ERWE451LGC332ME96M	
	1,200	35×120	0.25	4.20	ERWE351LGB122MAC0M		3,900	76.2×115	0.25	11.5	ERWE451LGC392MEB5M	
	1,500	50×75	0.25	4.70	ERWE351LGC152MC75M		4,700	76.2×130	0.25	13.3	ERWE451LGC472MED0M	
	2,200	50×96	0.25	6.30	ERWE351LGC222MEF5M		5,600	76.2×155	0.25	15.7	ERWE451LGC562MEF5M	
	3,300	50×130	0.25	8.80	ERWE351LGC332MCD0M		8,200	89×155	0.25	18.6	ERWE451LGC822MFF5M	
	3,300	63.5×96	0.25	8.80	ERWE351LGC332MD96M		500	120	35×50	0.25	0.70	ERWE501LGB121MA50M
	3,900	63.5×115	0.25	10.3	ERWE351LGC392MDB5M			270	35×80	0.25	1.20	ERWE501LGB271MA80M
	4,700	63.5×130	0.25	12.0	ERWE351LGC472MDD0M			330	35×100	0.25	1.40	ERWE501LGB331MAA0M
	4,700	76.2×96	0.25	11.7	ERWE351LGC472ME96M			390	35×120	0.25	1.70	ERWE501LGB391MAC0M
	5,600	76.2×115	0.25	12.6	ERWE351LGC562MEB5M			470	50×75	0.25	1.80	ERWE501LGC471MC75M
	6,800	76.2×130	0.25	15.9	ERWE351LGC682MED0M			680	50×96	0.25	2.50	ERWE501LGC681MC96M
	8,200	76.2×155	0.25	19.0	ERWE351LGC822MEF5M			820	50×115	0.25	2.90	ERWE501LGC821MCB5M
12,000	89×155	0.25	22.5	ERWE351LGC123MFF5M	1,000	50×130		0.25	3.40	ERWE501LGC102MCD0M		
400	330	35×50	0.25	1.70	ERWE401LGB331MA50M	1,000		63.5×96	0.25	3.40	ERWE501LGC102MD96M	
	560	35×80	0.25	2.70	ERWE401LGB561MA80M	1,500		63.5×115	0.25	4.50	ERWE501LGC152MDB5M	
	820	35×100	0.25	3.40	ERWE401LGB821MAA0M	1,500		76.2×96	0.25	4.60	ERWE501LGC152ME96M	
	1,000	35×120	0.25	3.90	ERWE401LGB102MAC0M	1,800		63.5×130	0.25	5.20	ERWE501LGC182MDD0M	
	1,200	50×75	0.25	4.20	ERWE401LGC122MC75M	2,200		76.2×115	0.25	6.10	ERWE501LGC222MEB5M	
	1,800	50×96	0.25	5.70	ERWE401LGC182MC96M	2,700		76.2×155	0.25	7.70	ERWE501LGC272MEF5M	
	2,200	50×130	0.25	7.20	ERWE401LGC222MCD0M	3,900	89×155	0.25	10.1	ERWE501LGC392MFF5M		
	2,700	63.5×96	0.25	7.90	ERWE401LGC272MD96M	550	100	35×50	0.25	0.60	ERWE551LGB101MA50M	
	3,300	63.5×115	0.25	9.50	ERWE401LGC332MDB5M		180	35×80	0.25	1.00	ERWE551LGB181MA80M	
	3,900	63.5×130	0.25	10.9	ERWE401LGC392MDD0M		270	35×100	0.25	1.30	ERWE551LGB271MAA0M	
	3,900	76.2×96	0.25	10.6	ERWE401LGC392ME96M		330	35×120	0.25	1.60	ERWE551LGB331MAC0M	
	4,700	76.2×115	0.25	12.6	ERWE401LGC472MEB5M		390	50×75	0.25	1.70	ERWE551LGC391MC75M	
	5,600	76.2×130	0.25	14.5	ERWE401LGC562MED0M		560	50×96	0.25	2.10	ERWE551LGC561MC96M	
	6,800	76.2×155	0.25	17.3	ERWE401LGC682MEF5M		560	63.5×96	0.25	2.50	ERWE551LGC561MD96M	
10,000	89×155	0.25	20.5	ERWE401LGC103MFF5M	680		50×115	0.25	2.70	ERWE551LGC681MCB5M		
450	270	35×50	0.25	1.60	ERWE451LGB271MA50M		680	63.5×115	0.25	3.00	ERWE551LGC681MDB5M	
	470	35×80	0.25	2.40	ERWE451LGB471MA80M		820	50×130	0.25	3.10	ERWE551LGC821MCD0M	
	680	35×100	0.25	3.10	ERWE451LGB681MAA0M		820	63.5×130	0.25	3.50	ERWE551LGC821MDD0M	
	820	35×120	0.25	3.50	ERWE451LGB821MAC0M		1,200	76.2×96	0.25	4.20	ERWE551LGC122ME96M	
	1,000	50×75	0.25	3.90	ERWE451LGC102MC75M		1,500	76.2×115	0.25	5.00	ERWE551LGC152MEB5M	
	1,200	50×96	0.25	4.70	ERWE451LGC122MC96M		1,800	76.2×130	0.25	5.80	ERWE551LGC182MED0M	
	1,500	50×115	0.25	5.60	ERWE451LGC152MCB5M	2,200	76.2×155	0.25	7.00	ERWE551LGC222MEF5M		
	1,800	50×130	0.25	6.50	ERWE451LGC182MCD0M	3,300	89×155	0.25	9.30	ERWE551LGC332MFF5M		
	2,200	63.5×96	0.25	7.20	ERWE451LGC222MD96M							

◆RATED RIPPLE CURRENT MULTIPLIERS
●Frequency Multipliers

Frequency (Hz)	50	120	300	1k	3k
Coefficient	0.8	1.0	1.1	1.3	1.4

Note : The endurance of capacitors is reduced with internal heating produced by ripple current at the rate of halving the lifetime with every 5 to 10°C rise. When long life performance is required in actual use, the rms ripple current has to be reduced. Also, for the RWE series capacitors, using them at operating voltage less than their rated voltage can extend their lifetime. For details, please contact a representative of Nippon Chemi-Con.

RWY Series

- High ripple capability
- Endurance with ripple current : 5,000 hours at 85°C
- Reduced cost design for three-phase input inverters
- RoHS Compliant

RWY

↑ Low price version
RWF



◆ SPECIFICATIONS

Items	Characteristics						
Category							
Temperature Range	-25 to +85°C						
Rated Voltage Range	350 to 450V _{dc}						
Capacitance Tolerance	±20% (M) (at 20°C, 120Hz)						
Leakage Current	I=0.02CV or 5mA, whichever is smaller. Where, I : Max. leakage current (μA), C : Nominal capacitance (μF), V : Rated voltage (V) (at 20°C after 5 minutes)						
Dissipation Factor (tanδ)	0.12 max. (at 20°C, 120Hz)						
Low Temperature Characteristics	Capacitance change $C(-25°C)/C(+20°C) \geq 0.7$ (at 120Hz)						
Insulation Resistance	When it is measured between the terminals that are connected to each other and to the mounting clamp on the insulating sleeve covering the case by using an insulation resistance meter of 500V _{dc} , the insulation resistance shall not be less than 100MΩ.						
Insulation Withstanding Voltage	When a voltage of 2,000V _{ac} is applied for 1 minute between the terminals that are connected to each other and to the mounting clamp on the insulating sleeve covering the case, there shall not be electrical damage.						
Endurance	The following specifications shall be satisfied when the capacitors are restored to 20°C after subjected to DC voltage with the rated ripple current is applied (the peak voltage shall not exceed the rated voltage) for 5,000 hours at 85°C.						
	<table border="1"> <tr> <td>Capacitance change</td> <td>≤±20% of the initial value</td> </tr> <tr> <td>D.F. (tanδ)</td> <td>≤200% of the initial specified value</td> </tr> <tr> <td>Leakage current</td> <td>≤The initial specified value</td> </tr> </table>	Capacitance change	≤±20% of the initial value	D.F. (tanδ)	≤200% of the initial specified value	Leakage current	≤The initial specified value
Capacitance change	≤±20% of the initial value						
D.F. (tanδ)	≤200% of the initial specified value						
Leakage current	≤The initial specified value						
Shelf Life	The following specifications shall be satisfied when the capacitors are restored to 20°C after exposing them for 1,000 hours at 85°C without voltage applied. Before the measurement, the capacitor shall be preconditioned by applying voltage according to Item 4.1 of JIS C 5101-4.						
	<table border="1"> <tr> <td>Capacitance change</td> <td>≤±20% of the initial value</td> </tr> <tr> <td>D.F. (tanδ)</td> <td>≤200% of the initial specified value</td> </tr> <tr> <td>Leakage current</td> <td>≤The initial specified value</td> </tr> </table>	Capacitance change	≤±20% of the initial value	D.F. (tanδ)	≤200% of the initial specified value	Leakage current	≤The initial specified value
Capacitance change	≤±20% of the initial value						
D.F. (tanδ)	≤200% of the initial specified value						
Leakage current	≤The initial specified value						

◆ DIMENSIONS (Screw-Mount) [mm]

● Terminal Code : LG

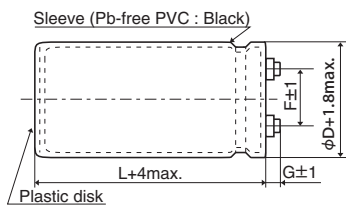

φ50 to φ76.2 : G=6
φ89 : G=4
φ100 : G=10

● Mounting Clamp Code : B

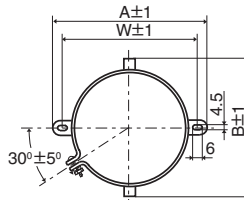

φD	A	B	W	F
50	78.0	64.0	68.0	22.4
63.5	90.0	76.0	80.0	28.0
76.2	104.5	90.0	93.5	31.5

● Mounting Clamp Code : C

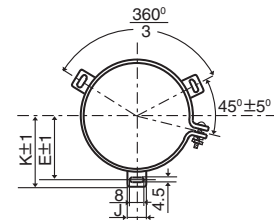

φD	E	K	F	J
50	32.5	37.0	22.4	14.0
63.5	38.1	43.5	28.0	14.0
76.2	44.5	50.0	31.5	14.0
89	50.8	56.5	31.5	16.0
100	56.5	63.4	41.5	18.0

<Screw specifications>

to φ89 Plus hexagon-headed screw : M5×0.8×10
Maximum screw tightening torque : 3.23Nm

φ100 Cross-recessed head (Phillips) screw : M8×1.25×16
Spring washer, Washer
Maximum screw tightening torque : 6.31Nm

* The screw and the mounting clamp are separately supplied and not attached to the product.

◆ PART NUMBERING SYSTEM

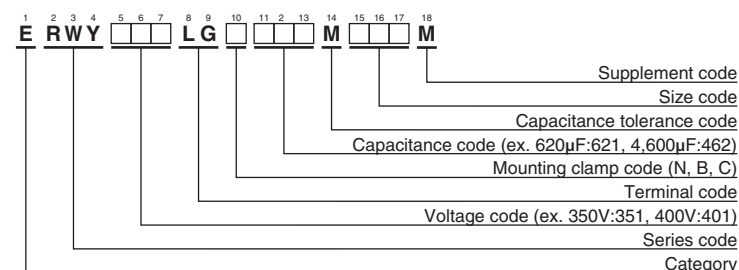

Please refer to "Product code guide (screw-mount terminal type)"

◆STANDARD RATINGS

WV (Vdc)	Cap (μF)	Case size φD×L(mm)	tan δ	Rated ripple current (Arms/85°C,300Hz)	Part No.	WV (Vdc)	Cap (μF)	Case size φD×L(mm)	tan δ	Rated ripple current (Arms/85°C,300Hz)	Part No.	
350	750	50×75	0.12	5.10	ERWY351LGC751MC75M	400	3,200	63.5×170	0.12	17.3	ERWY401LGC322MDH0M	
	1,100	50×96	0.12	6.90	ERWY351LGC112MC96M		3,400	76.2×130	0.12	17.5	ERWY401LGC342MED0M	
	1,300	50×105	0.12	7.80	ERWY351LGC132MCA5M		4,200	76.2×155	0.12	21.1	ERWY401LGC422MEF5M	
	1,600	50×130	0.12	9.50	ERWY351LGC162MCD0M		4,600	76.2×170	0.12	23.0	ERWY401LGC462MEH0M	
	1,800	63.5×96	0.12	10.0	ERWY351LGC182MD96M		5,700	89×155	0.12	24.7	ERWY401LGC572MFF5M	
	1,900	50×145	0.12	10.7	ERWY351LGC192MCE5M		6,400	89×170	0.12	27.0	ERWY401LGC642MFH0M	
	2,400	63.5×115	0.12	12.6	ERWY351LGC242MDB5M		7,000	89×190	0.12	30.0	ERWY401LGC702MFK0M	
	2,800	63.5×130	0.12	14.3	ERWY351LGC282MDD0M		7,900	100×190	0.12	34.0	ERWY401LGC792MGK0M	
	3,400	63.5×155	0.12	17.1	ERWY351LGC322MDF5M		9,400	100×220	0.12	39.6	ERWY401LGC942MGN0M	
	3,500	76.2×115	0.12	16.9	ERWY351LGC352MEB5M		12,000	100×270	0.12	49.2	ERWY401LGC123MGT0M	
	3,800	63.5×170	0.12	18.8	ERWY351LGC382MDH0M		450	500	50×75	0.12	4.00	ERWY451LGC501MC75M
	4,000	76.2×130	0.12	19.0	ERWY351LGC402MED0M			710	50×96	0.12	5.20	ERWY451LGC711MC96M
	5,000	76.2×155	0.12	23.0	ERWY351LGC502MEF5M			840	50×105	0.12	5.90	ERWY451LGC841MCA5M
	5,600	76.2×170	0.12	25.3	ERWY351LGC562MEH0M			1,100	50×130	0.12	7.50	ERWY451LGC112MCD0M
	6,900	89×155	0.12	27.2	ERWY351LGC692MFF5M			1,200	63.5×96	0.12	7.80	ERWY451LGC122MD96M
	7,700	89×170	0.12	29.6	ERWY351LGC772MFH0M			1,300	50×145	0.12	8.40	ERWY451LGC132MCE5M
8,400	89×190	0.12	32.9	ERWY351LGC842MFK0M	1,600	63.5×115		0.12	9.80	ERWY451LGC162MDB5M		
9,500	100×190	0.12	37.3	ERWY351LGC952MGK0M	1,800	63.5×130		0.12	10.9	ERWY451LGC182MDD0M		
11,000	100×220	0.12	42.9	ERWY351LGC113MGN0M	2,300	63.5×155		0.12	13.3	ERWY451LGC232MDF5M		
14,000	100×270	0.12	53.1	ERWY351LGC143MGT0M	2,300	76.2×115		0.12	13.0	ERWY451LGC232MEB5M		
400	620	50×75	0.12	4.60	ERWY401LGC621MC75M	2,500		63.5×170	0.12	14.5	ERWY451LGC252MDH0M	
	880	50×96	0.12	6.10	ERWY401LGC881MC96M	2,700		76.2×130	0.12	14.8	ERWY451LGC272MED0M	
	1,000	50×105	0.12	6.80	ERWY401LGC102MCA5M	3,300		76.2×155	0.12	17.7	ERWY451LGC332MEF5M	
	1,400	50×130	0.12	8.90	ERWY401LGC142MCD0M	3,700		76.2×170	0.12	19.5	ERWY451LGC372MEH0M	
	1,500	63.5×96	0.12	9.10	ERWY401LGC152MD96M	4,600		89×155	0.12	22.2	ERWY451LGC462MFF5M	
	1,600	50×145	0.12	9.90	ERWY401LGC162MCE5M	5,100		89×170	0.12	24.1	ERWY451LGC512MFH0M	
	2,000	63.5×115	0.12	11.5	ERWY401LGC202MDB5M	5,700	89×190	0.12	27.1	ERWY451LGC572MFK0M		
	2,300	63.5×130	0.12	13.0	ERWY401LGC232MDD0M	6,400	100×190	0.12	30.6	ERWY451LGC642MGK0M		
	2,800	63.5×155	0.12	15.5	ERWY401LGC282MDF5M	7,600	100×220	0.12	35.6	ERWY451LGC762MGN0M		
	2,900	76.2×115	0.12	15.4	ERWY401LGC292MEB5M	9,500	100×270	0.12	43.7	ERWY451LGC952MGT0M		

◆RATED RIPPLE CURRENT MULTIPLIERS
●Frequency Multipliers

Frequency (Hz)	120	300	1k	3k
Coefficient	0.83	1.00	1.25	1.33

Note : The endurance of capacitors is reduced with internal heating produced by ripple current at the rate of halving the lifetime with every 5 to 10°C rise. When long life performance is required in actual use, the rms ripple current has to be reduced. Also, for RWY series capacitors, using them at operating voltage less than their rated voltage can extend their lifetime. For details, please contact a representative of Nippon Chemi-Con.

RWL Series

- High ripple capability
- For train systems and high power consuming inverter circuits
- Endurance with ripple current : 20,000 hours at 85°C
- RoHS Compliant

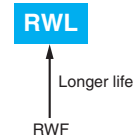

◆ SPECIFICATIONS

Items	Characteristics
Category	
Temperature Range	-25 to +85°C
Rated Voltage Range	350 to 450V _{dc}
Capacitance Tolerance	±20% (M) (at 20°C, 120Hz)
Leakage Current	I=0.02CV or 5mA, whichever is smaller. Where, I : Max. leakage current (μA), C : Nominal capacitance (μF), V : Rated voltage (V) (at 20°C after 5 minutes)
Dissipation Factor (tanδ)	0.25 max. (at 20°C, 120Hz)
Low Temperature Characteristics	Capacitance change $C(-25^{\circ}\text{C})/C(+20^{\circ}\text{C}) \geq 0.7$ (at 120Hz)
Insulation Resistance	When measured between the terminals that are connected to each other and to the mounting clamp on the insulating sleeve covering the case by using an insulation resistance meter of 500V _{dc} , the insulation resistance shall not be less than 100MΩ.
Insulation Withstanding Voltage	When a voltage of 2,000Vac is applied for 1 minute between the terminals that are connected to each other and to the mounting clamp on the insulating sleeve covering the case, there shall not be electrical damage.
Endurance	The following specifications shall be satisfied when the capacitors are restored to 20°C after subjected to DC voltage with the rated ripple current is applied (the peak voltage shall not exceed the rated voltage) for 20,000 hours at 85°C.
	Capacitance change $\leq \pm 30\%$ of the initial value
	D.F. (tanδ) $\leq 300\%$ of the initial specified value
	Leakage current \leq The initial specified value
Shelf Life	The following specifications shall be satisfied when the capacitors are restored to 20°C after exposing them for 500 hours at 85°C without voltage applied. Before the measurement, the capacitor shall be preconditioned by applying voltage according to Item 4.1 of JIS C 5101-4.
	Capacitance change $\leq \pm 20\%$ of the initial value
	D.F. (tanδ) $\leq 300\%$ of the initial specified value
	Leakage current \leq The initial specified value

◆ DIMENSIONS (Screw-Mount) [mm]

● Terminal Code : LG

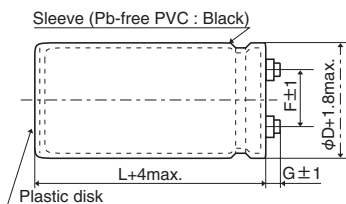

φ63.5 : G=6

φ76.2 & φ89 : G=5

● Mounting Clamp Code : B

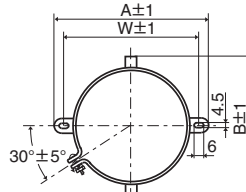

φD	A	B	W	F
63.5	90.0	76.0	80.0	28.0
76.2	104.5	90.0	93.5	31.5

● Mounting Clamp Code : C

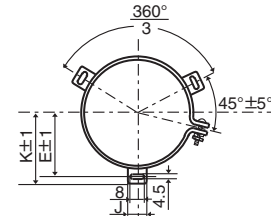

φD	E	K	F	J
63.5	38.1	43.5	28.0	14.0
76.2	44.5	50.0	31.5	14.0
89	50.8	56.5	31.5	16.0

<Screw specifications>

Plus hexagon-headed screw :M5×0.8×10

Maximum screw tightening torque :3.23Nm

* The screw and the mounting clamp are separately supplied and not attached to the product.

◆ PART NUMBERING SYSTEM

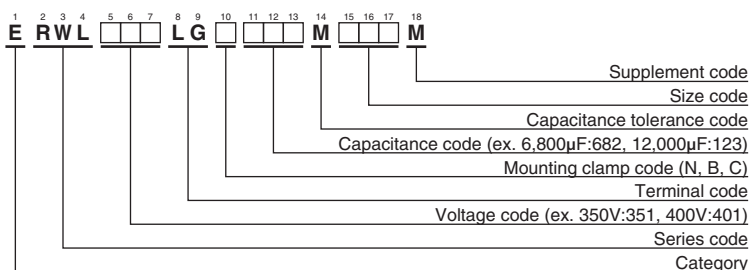

Please refer to "Product code guide (screw-mount terminal type)"

◆STANDARD RATINGS

WV (Vdc)	Cap (μF)	Case size φD×L(mm)	tan δ	Rated ripple current (Arms/85°C, 120Hz)	Part No.	WV (Vdc)	Cap (μF)	Case size φD×L(mm)	tan δ	Rated ripple current (Arms/85°C, 120Hz)	Part No.	
350	3,300	63.5×115	0.25	11.1	ERWL351LGC332MDB5M	400	5,600	63.5×190	0.25	18.2	ERWL401LGC562MDK0M	
	3,900	63.5×130	0.25	12.8	ERWL351LGC392MDD0M		5,600	76.2×155	0.25	18.3	ERWL401LGC562MEF5M	
	4,700	63.5×155	0.25	15.2	ERWL351LGC472MDF5M		6,800	76.2×170	0.25	21.0	ERWL401LGC682MEH0M	
	4,700	76.2×115	0.25	14.7	ERWL351LGC472MEB5M		8,200	89×155	0.25	24.1	ERWL401LGC822MFF5M	
	5,600	63.5×170	0.25	17.3	ERWL351LGC562MDH0M		10,000	89×190	0.25	29.1	ERWL401LGC103MFK0M	
	5,600	76.2×130	0.25	16.9	ERWL351LGC562MED0M		450	2,200	63.5×115	0.25	9.10	ERWL451LGC222MDB5M
	6,800	63.5×190	0.25	20.0	ERWL351LGC682MDK0M			2,700	63.5×130	0.25	10.6	ERWL451LGC272MDD0M
	6,800	76.2×155	0.25	20.2	ERWL351LGC682MEF5M			2,700	76.2×115	0.25	11.2	ERWL451LGC272MEB5M
	8,200	76.2×170	0.25	23.1	ERWL351LGC822MEH0M			3,300	63.5×155	0.25	12.7	ERWL451LGC332MDF5M
	10,000	89×155	0.25	26.6	ERWL351LGC103MFF5M			3,300	76.2×130	0.25	13.0	ERWL451LGC332MED0M
12,000	89×190	0.25	32.0	ERWL351LGC123MFK0M	3,900	63.5×170		0.25	14.4	ERWL451LGC392MDH0M		
400	2,700	63.5×115	0.25	10.1	ERWL401LGC272MDB5M	4,700		76.2×155	0.25	16.7	ERWL451LGC472MEF5M	
	3,300	63.5×130	0.25	11.7	ERWL401LGC332MDD0M	5,600		76.2×190	0.25	20.1	ERWL451LGC562MEK0M	
	3,900	63.5×155	0.25	13.8	ERWL401LGC392MDF5M	5,600		89×155	0.25	19.9	ERWL451LGC562MFF5M	
	3,900	76.2×115	0.25	14.7	ERWL401LGC392MEB5M	6,800		89×170	0.25	23.0	ERWL451LGC682MFH0M	
	4,700	63.5×170	0.25	15.8	ERWL401LGC472MDH0M	8,200	89×190	0.25	26.4	ERWL451LGC822MFK0M		
	4,700	76.2×130	0.25	15.5	ERWL401LGC472MED0M							

◆RATED RIPPLE CURRENT MULTIPLIERS
●Frequency Multipliers

Frequency (Hz)	50	120	300	1k	3k
Coefficient	0.8	1.0	1.1	1.3	1.4

Note : The endurance of capacitors is reduced with internal heating produced by ripple current at the rate of halving the lifetime with every 5 to 10°C rise. When long life performance is required in actual use, the rms ripple current has to be reduced. Also, for RWL series capacitors, using them at operating voltage less than their rated voltage can extend their lifetime. For details, please contact a representative of Nippon Chemi-Con.

FTP Series

- Ideal for inverter smoothing capacitors such as Electric Vehicles, Hybrid Cars, etc.
- Endurance with ripple current : 5,000 hours at 85°C
- Rated voltage range : 63 to 450V_{dc}
- Lower profile offers drastic space saving compared with conventional cylindrical type
- Superior heat radiation realizes higher ripple current
- RoHS Compliant



◆ SPECIFICATIONS

Items	Characteristics
Category	
Temperature Range	-40 to +85°C (63~100V _{dc}), -25 to +85°C (350~450V _{dc})
Rated Voltage Range	63 to 450V _{dc}
Capacitance Tolerance	±20% (M) (at 20°C, 120Hz)
Leakage Current	I=0.02CV or 5mA, whichever is smaller. Where, I : Max. leakage current (μA), C : Nominal capacitance (μF), V : Rated voltage (V) (at 20°C after 5 minutes)
Dissipation Factor (tanδ)	0.25 max. (at 20°C, 120Hz)
Low Temperature Characteristics	Capacitance change 63 to 100V _{dc} : C(-40°C)/C(+20°C) ≥ 0.6 350 to 450V _{dc} : C(-25°C)/C(+20°C) ≥ 0.7 (at 120Hz)
Endurance	The following specifications shall be satisfied when the capacitors are restored to 20°C after subjected to DC voltage with the rated ripple current is applied (the peak voltage shall not exceed the rated voltage) for 5,000 hours at 85°C.
	Capacitance change ≤ ±20% of the initial value
	D.F. (tanδ) ≤ 200% of the initial specified value
	Leakage current ≤ The initial specified value
Shelf Life	The following specifications shall be satisfied when the capacitors are restored to 20°C after exposing them for 1,000 hours at 85°C without voltage applied. Before the measurement, the capacitor shall be preconditioned by applying voltage according to Item 4.1 of JIS C 5101-4.
	Capacitance change ≤ ±20% of the initial value
	D.F. (tanδ) ≤ 200% of the initial specified value
	Leakage current ≤ The initial specified value

◆ DIMENSIONS (Screw-Mount) [mm]

- Terminal Code : LG
- Size Code : L

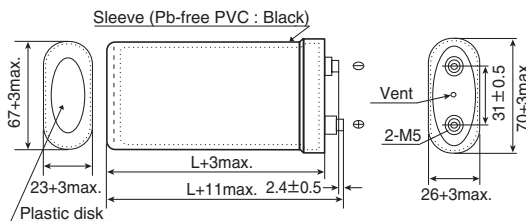

- Size Code : R

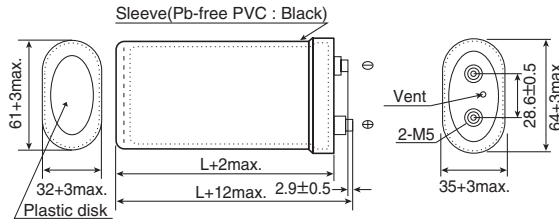

* Polyolefin is available upon request.

<Screw specifications>
Plus hexagon-headed screw: M5×0.8
Maximum screw tightening torque: 3.23Nm

◆ PART NUMBERING SYSTEM

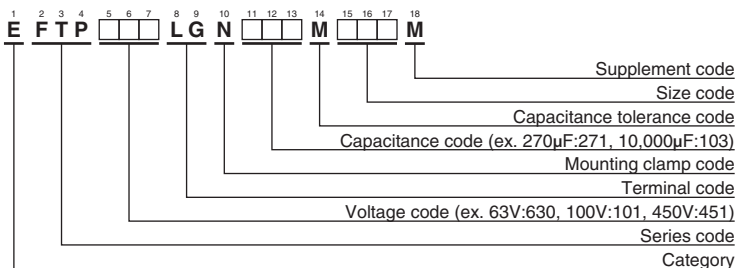

Please refer to "Product code guide (screw-mount terminal type)"

◆ SIZE CODE

Code	Case size H×W×L (mm)
L50	26×70×50
L75	26×70×75
L95	26×70×95
R50	35×64×50
R75	35×64×75
R95	35×64×95

◆STANDARD RATINGS

WV (Vdc)	Cap (μF)	Case size H×W×L(mm)	tanδ	Rated ripple current (Arms/85°C,10kHz)	Part No.	WV (Vdc)	Cap (μF)	Case size H×W×L(mm)	tanδ	Rated ripple current (Arms/85°C,10kHz)	Part No.
63	6,000	26×70×50	0.25	14.0	EFTP630LGN602ML50M	350	400	26×70×50	0.25	10.6	EFTP351LGN401ML50M
	12,000	26×70×75	0.25	19.0	EFTP630LGN123ML75M		800	26×70×75	0.25	15.7	EFTP351LGN801ML75M
	17,000	26×70×95	0.25	22.0	EFTP630LGN173ML95M		1,100	26×70×95	0.25	18.7	EFTP351LGN112ML95M
	7,400	35×64×50	0.25	16.1	EFTP630LGN742MR50M		490	35×64×50	0.25	11.9	EFTP351LGN491MR50M
	15,000	35×64×75	0.25	21.7	EFTP630LGN153MR75M		970	35×64×75	0.25	17.6	EFTP351LGN971MR75M
	21,000	35×64×95	0.25	25.3	EFTP630LGN213MR95M		1,400	35×64×95	0.25	21.0	EFTP351LGN142MR95M
80	4,300	26×70×50	0.25	14.0	EFTP800LGN432ML50M	400	330	26×70×50	0.25	10.6	EFTP401LGN331ML50M
	8,600	26×70×75	0.25	19.0	EFTP800LGN862ML75M		660	26×70×75	0.25	15.7	EFTP401LGN661ML75M
	12,000	26×70×95	0.25	22.0	EFTP800LGN123ML95M		930	26×70×95	0.25	18.7	EFTP401LGN931ML95M
	5,300	35×64×50	0.25	16.1	EFTP800LGN532MR50M		400	35×64×50	0.25	11.9	EFTP401LGN401MR50M
	10,000	35×64×75	0.25	21.7	EFTP800LGN103MR75M		800	35×64×75	0.25	17.6	EFTP401LGN801MR75M
	15,000	35×64×95	0.25	25.3	EFTP800LGN153MR95M		1,100	35×64×95	0.25	21.0	EFTP401LGN112MR95M
100	2,900	26×70×50	0.25	14.0	EFTP101LGN292ML50M	450	270	26×70×50	0.25	10.1	EFTP451LGN271ML50M
	5,700	26×70×75	0.25	19.0	EFTP101LGN572ML75M		540	26×70×75	0.25	15.0	EFTP451LGN541ML75M
	8,100	26×70×95	0.25	22.0	EFTP101LGN812ML95M		760	26×70×95	0.25	18.0	EFTP451LGN761ML95M
	3,600	35×64×50	0.25	16.1	EFTP101LGN362MR50M		330	35×64×50	0.25	11.4	EFTP451LGN331MR50M
	7,100	35×64×75	0.25	21.7	EFTP101LGN712MR75M		660	35×64×75	0.25	16.7	EFTP451LGN661MR75M
	10,000	35×64×95	0.25	25.3	EFTP101LGN103MR95M		930	35×64×95	0.25	20.1	EFTP451LGN931MR95M

◆Improvement of space factor and heat radiation

Dead spaces are found in the conventional cylindrical shape. But lower profile offers reduced dead space, and makes the equipment smaller in size. Moreover, the internal element of the lower profile capacitor is in greater contact with the can. This greatly improves the heat dissipation compared with the cylindrical shape.

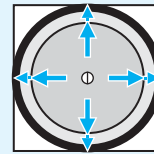

Cylindrical shape

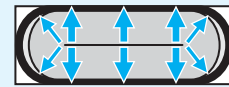

FTP series



LARGE CAPACITANCE ALUMINUM ELECTROLYTIC CAPACITORS long life screw terminals , 105°C

LXA Series

- Rated voltage range up to 525V_{dc}
- Endurance with ripple current : 5,000 hours at 105°C (2,000 hours for 500V_{dc} & 525V_{dc})
- High reliability products
- RoHS Compliant

LXA

Long life
KMH



◆ SPECIFICATIONS

Items	Characteristics												
Category Temperature Range	-40 to +105°C (10 to 100V _{dc}) -25 to +105°C (160 to 525V _{dc})												
Rated Voltage Range	10 to 525V _{dc}												
Capacitance Tolerance	-10 to +50% (T) (10 to 250V _{dc}) ±20% (M) (350 to 525V _{dc}) (at 20°C, 120Hz)												
Leakage Current	I=0.02CV or 5mA, whichever is smaller. Where, I : Max. leakage current (μA), C : Nominal capacitance (μF), V : Rated voltage (V) (at 20°C after 5 minutes)												
Dissipation Factor (tanδ)	See STANDARD RATINGS (10 to 250V _{dc}) 0.20max (350 to 525V _{dc}) (at 20°C, 120Hz)												
Low Temperature Characteristics	Capacitance change C(-40°C)/C(+20°C) ≥ 0.6 (10 to 100V _{dc}) C(-25°C)/C(+20°C) ≥ 0.7 (160 to 250V _{dc}) C(-25°C)/C(+20°C) ≥ 0.65 (350 to 525V _{dc}) (at 120Hz)												
Insulation Resistance	When measured between the terminals that are connected to each other and to the mounting clamp on the insulating sleeve covering the case by using an insulation resistance meter of 500V _{dc} , the insulation resistance shall not be less than 100MΩ.												
Insulation Withstanding Voltage	When a voltage of 2,000V _{ac} is applied for 1 minute between the terminals that are connected to each other and to the mounting clamp on the insulating sleeve covering the case, there shall not be electrical damage.												
Endurance	The following specifications shall be satisfied when the capacitors are restored to 20°C after subjected to DC voltage with the rated ripple current is applied (the peak voltage shall not exceed the rated voltage) for 5,000 hours (2,000 hours for 500 & 525V _{dc} products) at 105°C. <table border="1"> <tr> <td>Capacitance change</td> <td>≤ ±20% of the initial value</td> </tr> <tr> <td>D.F. (tanδ)</td> <td>≤ 200% of the initial specified value</td> </tr> <tr> <td>Leakage current</td> <td>≤ The initial specified value</td> </tr> </table>	Capacitance change	≤ ±20% of the initial value	D.F. (tanδ)	≤ 200% of the initial specified value	Leakage current	≤ The initial specified value						
Capacitance change	≤ ±20% of the initial value												
D.F. (tanδ)	≤ 200% of the initial specified value												
Leakage current	≤ The initial specified value												
Shelf Life	The following specifications shall be satisfied when the capacitors are restored to 20°C after exposing them for 1,000 hours at 105°C without voltage applied. Before the measurement, the capacitor shall be preconditioned by applying voltage according to Item 4.1 of JIS C 5101-4. <table border="1"> <tr> <td>Rated voltage</td> <td>10 to 250V_{dc}</td> <td>350 to 525V_{dc}</td> </tr> <tr> <td>Capacitance change</td> <td>≤ ±15% of the initial value</td> <td>≤ ±20% of the initial value</td> </tr> <tr> <td>D.F. (tanδ)</td> <td>≤ 150% of the initial specified value</td> <td>≤ 200% of the initial specified value</td> </tr> <tr> <td>Leakage current</td> <td>≤ The initial specified value</td> <td>≤ The initial specified value</td> </tr> </table>	Rated voltage	10 to 250V _{dc}	350 to 525V _{dc}	Capacitance change	≤ ±15% of the initial value	≤ ±20% of the initial value	D.F. (tanδ)	≤ 150% of the initial specified value	≤ 200% of the initial specified value	Leakage current	≤ The initial specified value	≤ The initial specified value
Rated voltage	10 to 250V _{dc}	350 to 525V _{dc}											
Capacitance change	≤ ±15% of the initial value	≤ ±20% of the initial value											
D.F. (tanδ)	≤ 150% of the initial specified value	≤ 200% of the initial specified value											
Leakage current	≤ The initial specified value	≤ The initial specified value											

◆ DIMENSIONS (Screw-Mount) [mm]

● Terminal Code : LG

● Mounting Clamp Code : B

● Mounting Clamp Code : C

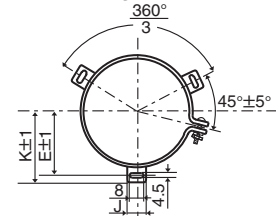
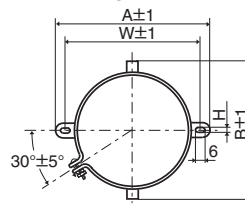
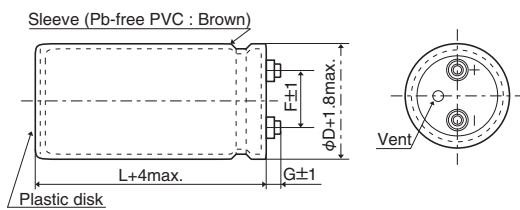

φD	G	
	10 to 250V _{dc}	350 to 525V _{dc}
~φ63.5	6	6
φ76.2	5	6
φ89	5	4

φD	A	B	W	H	F
35	58	44	48	3.5	12.7
50	78	64	68	4.5	22.4
63.5	90	76	80	4.5	28.0
76.2	104.5	90	93.5	4.5	31.5

φD	E	K	J	F
50	32.5	37.0	14.0	22.4
63.5	38.1	43.5	14.0	28.0
76.2	44.5	50.0	14.0	31.5
89	50.8	56.5	16.0	31.5

<Screw specifications>

Plus hexagon-headed screw : M5×0.8×10

Maximum screw tightening torque : 3.23Nm

* The screw and the mounting clamp are separately supplied and not attached to the product.

◆ PART NUMBERING SYSTEM

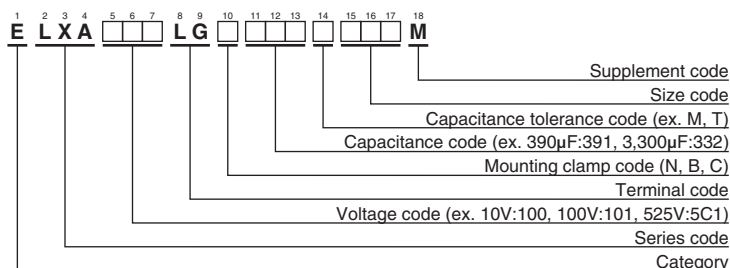

Please refer to "Product code guide (screw-mount terminal type)"



◆STANDARD RATINGS

WV (Vdc)	Cap (μF)	Case size φD×L(mm)	tanδ	Rated ripple current (Arms/105°C,120Hz)	Part No.	WV (Vdc)	Cap (μF)	Case size φD×L(mm)	tanδ	Rated ripple current (Arms/105°C,120Hz)	Part No.	
10	27,000	35×80	0.45	4.30	ELXA100LGB273TA80M	50	10,000	35×80	0.25	3.70	ELXA500LGB103TA80M	
	33,000	35×80	0.45	4.70	ELXA100LGB333TA80M		12,000	35×100	0.25	4.40	ELXA500LGB123TAA0M	
	39,000	35×80	0.45	5.30	ELXA100LGB393TA80M		15,000	35×120	0.30	4.70	ELXA500LGB153TAC0M	
	47,000	35×100	0.45	6.10	ELXA100LGB473TAA0M		18,000	50×80	0.35	4.80	ELXA500LGC183TC80M	
	56,000	35×100	0.50	6.20	ELXA100LGB563TAA0M		22,000	50×100	0.35	5.90	ELXA500LGC223TCA0M	
	68,000	35×120	0.60	6.80	ELXA100LGB683TAC0M		27,000	50×120	0.35	7.00	ELXA500LGC273TCC0M	
	82,000	50×80	0.60	7.80	ELXA100LGC823TC80M		33,000	63.5×100	0.40	7.60	ELXA500LGC333TDA0M	
	100,000	50×100	0.70	8.50	ELXA100LGC104TCA0M		39,000	63.5×120	0.40	8.90	ELXA500LGC393TDC0M	
	120,000	50×100	0.70	9.50	ELXA100LGC124TCA0M		47,000	63.5×120	0.40	9.80	ELXA500LGC473TDC0M	
	150,000	63.5×100	0.80	11.0	ELXA100LGC154TDA0M		56,000	76.2×120	0.40	11.9	ELXA500LGC563TEC0M	
	180,000	63.5×100	0.80	12.1	ELXA100LGC184TDA0M		68,000	76.2×140	0.45	13.1	ELXA500LGC683TEE0M	
	220,000	76.2×100	1.00	13.2	ELXA100LGC224TEA0M		82,000	89×140	0.50	14.8	ELXA500LGC823TFE0M	
	270,000	76.2×120	1.20	14.4	ELXA100LGC274TEC0M		63	2,700	35×50	0.15	1.90	ELXA630LGB272TA50M
	330,000	76.2×140	1.20	17.0	ELXA100LGC334TEE0M			3,300	35×50	0.15	2.10	ELXA630LGB332TA50M
	390,000	89×140	1.40	18.6	ELXA100LGC394TFE0M			3,900	35×80	0.20	2.70	ELXA630LGB392TA80M
16	15,000	35×50	0.45	2.90	ELXA160LGB153TA50M	4,700		35×80	0.20	2.90	ELXA630LGB472TA80M	
	18,000	35×80	0.45	3.50	ELXA160LGB183TA80M	5,600		35×80	0.20	3.20	ELXA630LGB562TA80M	
	22,000	35×80	0.45	3.90	ELXA160LGB223TA80M	6,800		35×80	0.20	3.50	ELXA630LGB682TA80M	
	27,000	35×80	0.45	4.30	ELXA160LGB273TA80M	8,200		35×100	0.20	4.20	ELXA630LGB822TAA0M	
	33,000	35×100	0.50	4.80	ELXA160LGB333TAA0M	10,000		35×120	0.25	4.30	ELXA630LGB103TAC0M	
	39,000	35×100	0.50	5.30	ELXA160LGB393TAA0M	12,000		50×80	0.25	4.80	ELXA630LGC123TC80M	
	47,000	35×120	0.50	6.20	ELXA160LGB473TAC0M	15,000		50×100	0.25	5.90	ELXA630LGC153TCA0M	
	56,000	50×80	0.60	6.30	ELXA160LGC563TC80M	18,000		50×120	0.25	6.30	ELXA630LGC183TCC0M	
	68,000	50×100	0.60	7.60	ELXA160LGC683TCA0M	22,000		50×120	0.30	6.70	ELXA630LGC223TCC0M	
	82,000	50×120	0.70	8.30	ELXA160LGC823TCC0M	27,000		63.5×120	0.30	8.80	ELXA630LGC273TDC0M	
	100,000	50×120	0.70	9.20	ELXA160LGC104TCC0M	33,000		76.2×100	0.30	10.0	ELXA630LGC332TEA0M	
	120,000	63.5×100	0.80	9.90	ELXA160LGC124TDA0M	39,000		76.2×120	0.35	10.7	ELXA630LGC393TEC0M	
	150,000	76.2×100	0.80	12.3	ELXA160LGC154TEA0M	47,000	76.2×140	0.35	12.5	ELXA630LGC473TEE0M		
	180,000	76.2×120	0.80	14.5	ELXA160LGC184TEC0M	56,000	89×140	0.40	13.8	ELXA630LGC563TFE0M		
	220,000	76.2×140	1.00	15.2	ELXA160LGC224TEE0M	80	2,200	35×50	0.15	1.90	ELXA800LGB222TA50M	
270,000	89×140	1.20	16.8	ELXA160LGC274TFE0M	2,700		35×80	0.15	2.20	ELXA800LGB272TA80M		
25	12,000	35×80	0.35	3.30	ELXA250LGB123TA80M		3,300	35×80	0.15	2.50	ELXA800LGB332TA80M	
	15,000	35×80	0.35	3.70	ELXA250LGB153TA80M		3,900	35×80	0.15	2.90	ELXA800LGB392TA80M	
	18,000	35×80	0.35	4.00	ELXA250LGB183TA80M		4,700	35×100	0.15	3.10	ELXA800LGB472TAA0M	
	22,000	35×80	0.35	4.50	ELXA250LGB223TA80M		5,600	35×100	0.15	3.50	ELXA800LGB562TAA0M	
	27,000	35×100	0.40	5.00	ELXA250LGB273TAA0M		6,800	35×120	0.20	4.10	ELXA800LGB682TAC0M	
	33,000	35×120	0.40	5.90	ELXA250LGB333TAC0M		8,200	50×80	0.20	4.80	ELXA800LGC822TC80M	
	39,000	50×80	0.40	6.50	ELXA250LGC393TC80M		10,000	50×100	0.20	5.60	ELXA800LGC103TCA0M	
	47,000	50×100	0.40	7.90	ELXA250LGC473TCA0M		12,000	50×100	0.20	6.10	ELXA800LGC123TCA0M	
	56,000	50×120	0.40	8.80	ELXA250LGC563TCC0M		15,000	50×120	0.20	7.40	ELXA800LGC153TCC0M	
	68,000	50×120	0.50	9.10	ELXA250LGC683TCC0M		18,000	63.5×120	0.25	8.00	ELXA800LGC183TDC0M	
	82,000	63.5×100	0.50	10.6	ELXA250LGC823TDA0M		22,000	76.2×100	0.25	9.10	ELXA800LGC223TEA0M	
	100,000	63.5×120	0.60	11.4	ELXA250LGC104TDC0M		27,000	76.2×120	0.30	9.70	ELXA800LGC273TEC0M	
	120,000	76.2×100	0.60	12.8	ELXA250LGC124TEA0M		33,000	76.2×140	0.30	11.5	ELXA800LGC333TEE0M	
	150,000	76.2×120	0.75	13.7	ELXA250LGC154TEE0M	39,000	89×140	0.35	12.5	ELXA800LGC393TFE0M		
	180,000	76.2×140	0.75	16.1	ELXA250LGC184TEE0M	100	1,200	35×50	0.15	1.40	ELXA101LGB122TA50M	
220,000	89×140	1.00	16.6	ELXA250LGC224TFE0M	1,500		35×80	0.15	1.60	ELXA101LGB152TA80M		
35	8,200	35×80	0.30	3.00	ELXA350LGB822TA80M		1,800	35×80	0.15	1.80	ELXA101LGB182TA80M	
	10,000	35×80	0.30	3.30	ELXA350LGB103TA80M		2,200	35×80	0.15	2.00	ELXA101LGB222TA80M	
	12,000	35×80	0.30	3.60	ELXA350LGB123TA80M		2,700	35×80	0.15	2.40	ELXA101LGB272TA80M	
	15,000	35×80	0.30	4.10	ELXA350LGB153TA80M		3,300	35×100	0.15	2.80	ELXA101LGB332TAA0M	
	18,000	35×100	0.30	4.80	ELXA350LGB183TAA0M		3,900	35×120	0.15	3.10	ELXA101LGB392TAC0M	
	22,000	35×120	0.35	5.20	ELXA350LGB223TAC0M		4,700	50×80	0.15	3.60	ELXA101LGC472TC80M	
	27,000	50×80	0.40	5.90	ELXA350LGC273TC80M		5,600	50×100	0.15	4.30	ELXA101LGC562TCA0M	
	33,000	50×100	0.40	6.60	ELXA350LGC333TCA0M		6,800	50×120	0.15	5.00	ELXA101LGC682TCC0M	
	39,000	50×120	0.40	7.80	ELXA350LGC393TCC0M		8,200	50×120	0.15	5.50	ELXA101LGC822TCC0M	
	47,000	50×120	0.45	8.00	ELXA350LGC473TCC0M		10,000	63.5×100	0.15	6.40	ELXA101LGC103TDA0M	
	56,000	63.5×100	0.45	9.20	ELXA350LGC563TDA0M		12,000	63.5×120	0.20	6.60	ELXA101LGC123TDC0M	
	68,000	63.5×120	0.45	11.0	ELXA350LGC683TDC0M		15,000	76.2×100	0.20	7.50	ELXA101LGC153TEA0M	
	82,000	76.2×120	0.50	12.7	ELXA350LGC823TEC0M		18,000	76.2×120	0.25	8.00	ELXA101LGC183TEC0M	
	100,000	76.2×140	0.60	13.5	ELXA350LGC104TEE0M	22,000	76.2×140	0.25	9.40	ELXA101LGC223TEE0M		
	120,000	89×140	0.60	16.1	ELXA350LGC124TFE0M	27,000	89×140	0.30	10.4	ELXA101LGC273TFE0M		
50	3,900	35×50	0.20	2.00	ELXA500LGB392TA50M	160	680	35×50	0.15	1.10	ELXA161LGB681TA50M	
	4,700	35×50	0.25	2.20	ELXA500LGB472TA50M		820	35×80	0.15	1.20	ELXA161LGB821TA80M	
	5,600	35×80	0.25	2.80	ELXA500LGB562TA80M		1,000	35×80	0.15	1.30	ELXA161LGB102TA80M	
	6,800	35×80	0.25	3.00	ELXA500LGB682TA80M		1,200	35×80	0.15	1.50	ELXA161LGB122TA80M	
	8,200	35×80	0.25	3.30	ELXA500LGB822TA80M		1,500	35×80	0.15	1.70	ELXA161LGB152TA80M	

◆STANDARD RATINGS

WV (Vdc)	Cap (μF)	Case size φD×L(mm)	tanδ	Rated ripple current (Arms/105°C,120Hz)	Part No.	WV (Vdc)	Cap (μF)	Case size φD×L(mm)	tanδ	Rated ripple current (Arms/105°C,120Hz)	Part No.	
160	1,800	35×100	0.15	2.00	ELXA161LGB182TAA0M	400	680	50×60	0.20	3.00	ELXA401LGC681MC60M	
	2,200	35×120	0.15	2.30	ELXA161LGB222TAC0M		1,200	50×85	0.20	4.70	ELXA401LGC122MC85M	
	2,700	35×120	0.15	2.70	ELXA161LGB272TAC0M		1,800	50×105	0.20	6.30	ELXA401LGC182MCA5M	
	3,300	50×100	0.15	3.30	ELXA161LGC332TCA0M		2,200	50×125	0.20	7.50	ELXA401LGC222MCC5M	
	3,900	50×120	0.15	3.80	ELXA161LGC392TCC0M		2,200	63.5×85	0.20	7.30	ELXA401LGC222MD85M	
	4,700	50×120	0.15	4.20	ELXA161LGC472TCC0M		2,700	50×145	0.20	8.90	ELXA401LGC272MCE5M	
	5,600	50×120	0.15	4.70	ELXA161LGC562TCC0M		2,700	63.5×105	0.20	8.80	ELXA401LGC272MDA5M	
	6,800	63.5×120	0.15	5.70	ELXA161LGC682TDC0M		3,300	63.5×125	0.20	10.5	ELXA401LGC332MDC5M	
	8,200	76.2×100	0.20	6.40	ELXA161LGC822TEA0M		3,300	76.2×85	0.20	9.90	ELXA401LGC332ME85M	
	10,000	76.2×120	0.20	6.60	ELXA161LGC103TEC0M		4,700	63.5×145	0.20	13.4	ELXA401LGC472MDE5M	
	12,000	76.2×140	0.20	7.80	ELXA161LGC123TEE0M		4,700	76.2×125	0.20	13.9	ELXA401LGC472MEC5M	
	15,000	89×140	0.20	9.50	ELXA161LGC153TFE0M		6,800	76.2×145	0.20	17.9	ELXA401LGC682MEE5M	
	200	470	35×50	0.15	0.90		ELXA201LGB471TA50M	6,800	89×125	0.20	17.2	ELXA401LGC682MFC5M
		560	35×80	0.15	1.00		ELXA201LGB561TA80M	8,200	76.2×190	0.20	20.8	ELXA401LGC822MEK0M
		680	35×80	0.15	1.10		ELXA201LGB681TA80M	8,200	89×145	0.20	20.1	ELXA401LGC822MFE5M
820		35×80	0.15	1.30	ELXA201LGB821TA80M	12,000	89×190	0.20	27.4	ELXA401LGC123MFK0M		
1,000		35×100	0.15	1.50	ELXA201LGB102TAA0M	18,000	89×270	0.20	39.4	ELXA401LGC183MFT0M		
1,200		35×120	0.15	1.70	ELXA201LGB122TAC0M	560	50×60	0.20	2.60	ELXA451LGC561MC60M		
1,500		35×120	0.15	1.90	ELXA201LGB152TAC0M	1,000	50×85	0.20	4.00	ELXA451LGC102MC85M		
1,800		50×80	0.15	2.20	ELXA201LGC182TC80M	1,200	50×105	0.20	4.80	ELXA451LGC122MCA5M		
2,200		50×100	0.15	2.70	ELXA201LGC222TCA0M	1,800	50×125	0.20	6.40	ELXA451LGC182MCC5M		
2,700		50×120	0.15	3.20	ELXA201LGC272TCC0M	1,800	63.5×85	0.20	6.20	ELXA451LGC182MD85M		
3,300		50×120	0.15	3.50	ELXA201LGC332TCC0M	2,200	50×145	0.20	7.60	ELXA451LGC222MCE5M		
3,900		63.5×100	0.15	4.00	ELXA201LGC392TDA0M	2,200	63.5×105	0.20	7.50	ELXA451LGC222MDA5M		
4,700		63.5×120	0.15	4.70	ELXA201LGC472TDC0M	2,700	63.5×125	0.20	8.90	ELXA451LGC272MDC5M		
5,600		76.2×100	0.15	5.30	ELXA201LGC562TEA0M	2,700	76.2×85	0.20	8.40	ELXA451LGC182MD85M		
6,800		76.2×120	0.15	6.30	ELXA201LGC682TEC0M	3,300	63.5×145	0.20	10.6	ELXA451LGC332MDE5M		
8,200	76.2×140	0.20	6.40	ELXA201LGC822TEE0M	3,300	76.2×105	0.20	10.2	ELXA451LGC332MEA5M			
10,000	89×140	0.20	7.70	ELXA201LGC103TFE0M	3,900	76.2×125	0.20	11.9	ELXA451LGC392MEC5M			
250	330	35×50	0.15	0.70	ELXA251LGB331TA50M	4,700	76.2×145	0.20	14.0	ELXA451LGC472MDE5M		
	390	35×80	0.15	0.80	ELXA251LGB391TA80M	5,600	89×125	0.20	14.2	ELXA451LGC562MFC5M		
	470	35×80	0.15	0.90	ELXA251LGB471TA80M	6,800	76.2×190	0.20	17.3	ELXA451LGC682MEK0M		
	560	35×80	0.15	1.00	ELXA251LGB561TA80M	6,800	89×145	0.20	16.7	ELXA451LGC682MFE5M		
	680	35×100	0.15	1.20	ELXA251LGB681TA80M	10,000	89×190	0.20	22.8	ELXA451LGC103MFK0M		
	820	35×100	0.15	1.40	ELXA251LGB821TAA0M	15,000	89×270	0.20	32.8	ELXA451LGC153MFT0M		
	1,000	35×120	0.15	1.60	ELXA251LGB102TAC0M	470	50×60	0.20	2.40	ELXA501LGC471MC60M		
	1,200	50×80	0.15	1.80	ELXA251LGC122TC80M	820	50×85	0.20	3.60	ELXA501LGC821MC85M		
	1,500	50×100	0.15	2.20	ELXA251LGC152TCA0M	1,000	50×105	0.20	4.40	ELXA501LGC102MCA5M		
	1,800	50×120	0.15	2.60	ELXA251LGC182TCC0M	1,200	50×125	0.20	5.20	ELXA501LGC122MCC5M		
	2,200	50×120	0.15	2.80	ELXA251LGC222TCC0M	1,200	63.5×85	0.20	5.00	ELXA501LGC122MD85M		
	2,700	63.5×100	0.15	3.30	ELXA251LGC272TDA0M	1,500	50×145	0.20	6.30	ELXA501LGC152MCE5M		
	3,300	63.5×120	0.15	4.00	ELXA251LGC332TDC0M	1,800	63.5×105	0.20	6.80	ELXA501LGC182MDA5M		
	3,900	76.2×100	0.15	4.40	ELXA251LGC392TEA0M	2,700	63.5×145	0.20	9.60	ELXA501LGC272MDE5M		
	4,700	76.2×120	0.15	5.20	ELXA251LGC472TEC0M	2,700	76.2×105	0.20	9.20	ELXA501LGC272MEA5M		
5,600	76.2×140	0.15	6.10	ELXA251LGC562TEE0M	3,900	76.2×145	0.20	12.7	ELXA501LGC392MEE5M			
6,800	89×140	0.15	7.40	ELXA251LGC682TFE0M	3,900	89×125	0.20	11.9	ELXA501LGC392MFC5M			
350	820	50×60	0.20	3.30	ELXA351LGC821MC60M	6,800	89×190	0.20	18.8	ELXA501LGC682MFK0M		
	1,500	50×85	0.20	5.20	ELXA351LGC152MC85M	10,000	89×270	0.20	26.8	ELXA501LGC103MFT0M		
	2,200	50×105	0.20	7.00	ELXA351LGC222MCA5M	390	50×60	0.20	2.20	ELXA5C1LGC391MC60M		
	2,700	50×125	0.20	8.40	ELXA351LGC272MCC5M	680	50×85	0.20	3.30	ELXA5C1LGC681MC85M		
	2,700	63.5×85	0.20	8.10	ELXA351LGC272MD85M	1,000	50×125	0.20	4.80	ELXA5C1LGC102MCC5M		
	3,300	50×145	0.20	9.90	ELXA351LGC332MCE5M	1,500	63.5×105	0.20	6.20	ELXA5C1LGC152MDA5M		
	3,300	63.5×105	0.20	9.80	ELXA351LGC332MDA5M	1,800	63.5×125	0.20	7.30	ELXA5C1LGC182MDC5M		
	3,900	63.5×125	0.20	11.5	ELXA351LGC392MDC5M	2,200	63.5×145	0.20	8.60	ELXA5C1LGC222MDE5M		
	3,900	76.2×85	0.20	10.8	ELXA351LGC392ME85M	2,200	76.2×105	0.20	8.30	ELXA5C1LGC222MEA5M		
	5,600	63.5×145	0.20	14.7	ELXA351LGC562MDE5M	2,700	76.2×125	0.20	9.90	ELXA5C1LGC272MEC5M		
	6,800	76.2×125	0.20	16.8	ELXA351LGC682MEC5M	3,300	76.2×145	0.20	11.7	ELXA5C1LGC332MEE5M		
	8,200	76.2×145	0.20	19.6	ELXA351LGC822MEE5M	4,700	76.2×190	0.20	14.4	ELXA5C1LGC472MEK0M		
	8,200	89×125	0.20	18.9	ELXA351LGC822MFC5M	4,700	89×145	0.20	13.9	ELXA5C1LGC472MFE5M		
	10,000	76.2×190	0.20	23.0	ELXA351LGC103MEK0M	5,600	89×190	0.20	17.1	ELXA5C1LGC562MFK0M		
	10,000	89×145	0.20	22.2	ELXA351LGC103MFE5M							
15,000	89×190	0.20	30.6	ELXA351LGC153MFK0M								
22,000	89×270	0.20	43.5	ELXA351LGC223MFT0M								



LXA Series

◆RATED RIPPLE CURRENT MULTIPLIERS

●Frequency Multipliers

Frequency (Hz)	50	120	300	1k	3k	10k	50k
10 to 50V _{dc}	0.95	1.00	1.03	1.05	—	1.09	1.12
63 to 80V _{dc}	0.90	1.00	1.06	1.10	—	1.18	1.22
100 to 250V _{dc}	0.80	1.00	1.12	1.22	—	1.30	1.33
350 to 525V _{dc}	0.80	1.00	1.20	1.50	1.60	—	—

Note : The endurance of capacitors is reduced with internal heating produced by ripple current at the rate of halving the lifetime with every 5 to 10°C rise. When long life performance is requested in actual use, the rms ripple current has to be reduced. Also, for the LXA series capacitors (350 to 525V_{dc} products), using them at operating voltage can extend their lifetime. For details, please contact a representative of Nippon Chemi-con.



LXR Series

- Higher ripple capability than LXA series
- Endurance with ripple current : 5,000 hours at 105°C
- RoHS Compliant

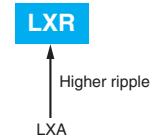

◆SPECIFICATIONS

Items	Characteristics						
Category Temperature Range	-25 to +105°C						
Rated Voltage Range	350 to 450V _{dc}						
Capacitance Tolerance	±20% (M) (at 20°C, 120Hz)						
Leakage Current	I=0.02CV or 5mA, whichever is smaller. Where, I : Max. leakage current (μA), C : Nominal capacitance (μF), V : Rated voltage (V) (at 20°C after 5 minutes)						
Dissipation Factor (tanδ)	0.15max. (at 20°C, 120Hz)						
Low Temperature Characteristics	Capacitance change $C(-25^{\circ}\text{C})/C(+20^{\circ}\text{C}) \geq 0.7$ (at 120Hz)						
Insulation Resistance	When measured between the terminals that are connected to each other and to the mounting clamp on the insulating sleeve covering the case by using an insulation resistance meter of 500V _{dc} , the insulation resistance shall not be less than 100MΩ.						
Insulation Withstanding Voltage	When a voltage of 2,000V _{dc} is applied for 1 minute between the terminals that are connected to each other and to the mounting clamp on the insulating sleeve covering the case, there shall not be electrical damage.						
Endurance	The following specifications shall be satisfied when the capacitors are restored to 20°C after subjected to DC voltage with the rated ripple current is applied (the peak voltage shall not exceed the rated voltage) for 5,000 hours at 105°C.						
	<table border="1"> <tr> <td>Capacitance change</td> <td>≤±20% of the initial value</td> </tr> <tr> <td>D.F. (tanδ)</td> <td>≤200% of the initial specified value</td> </tr> <tr> <td>Leakage current</td> <td>≤The initial specified value</td> </tr> </table>	Capacitance change	≤±20% of the initial value	D.F. (tanδ)	≤200% of the initial specified value	Leakage current	≤The initial specified value
Capacitance change	≤±20% of the initial value						
D.F. (tanδ)	≤200% of the initial specified value						
Leakage current	≤The initial specified value						
Shelf Life	The following specifications shall be satisfied when the capacitors are restored to 20°C after exposing them for 1,000 hours at 105°C without voltage applied. Before the measurement, the capacitor shall be preconditioned by applying voltage according to Item 4.1 of JIS C 5101-4.						
	<table border="1"> <tr> <td>Capacitance change</td> <td>≤±20% of the initial value</td> </tr> <tr> <td>D.F. (tanδ)</td> <td>≤200% of the initial specified value</td> </tr> <tr> <td>Leakage current</td> <td>≤The initial specified value</td> </tr> </table>	Capacitance change	≤±20% of the initial value	D.F. (tanδ)	≤200% of the initial specified value	Leakage current	≤The initial specified value
Capacitance change	≤±20% of the initial value						
D.F. (tanδ)	≤200% of the initial specified value						
Leakage current	≤The initial specified value						

◆DIMENSIONS (Screw-Mount) [mm]

● Terminal Code : LG

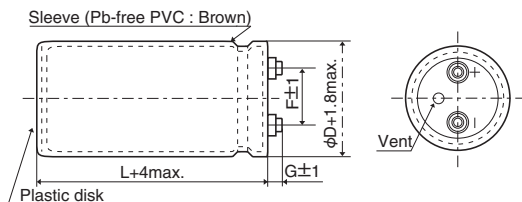

φ63.5 & φ76.2 : G=6
φ89 : G=4
φ100 : G=10

<Screw specifications>
to φ89 Plus hexagon-headed screw :M5×0.8×10
Maximum screw tightening torque :3.23Nm

● Mounting Clamp Code : B

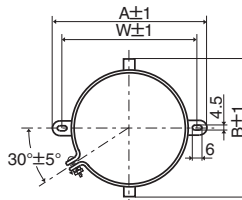

φD	A	B	W	F
63.5	90	76	80	28.0
76.2	104.5	90	93.5	31.5

● Mounting Clamp Code : C

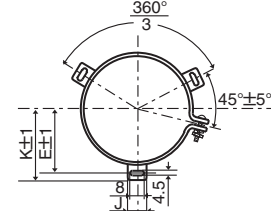

φD	E	K	F	J
63.5	38.1	43.5	28.0	14.0
76.2	44.5	50.0	31.5	14.0
89	50.8	56.5	31.5	16.0
100	56.5	63.4	41.5	18.0

φ100 Cross-recessed head (Phillips) screw : M8×1.25×16
Spring washer, Washer
Maximum screw tightening torque :6.31Nm

* The screw and the mounting clamp are separately supplied and not attached to the product.

◆PART NUMBERING SYSTEM

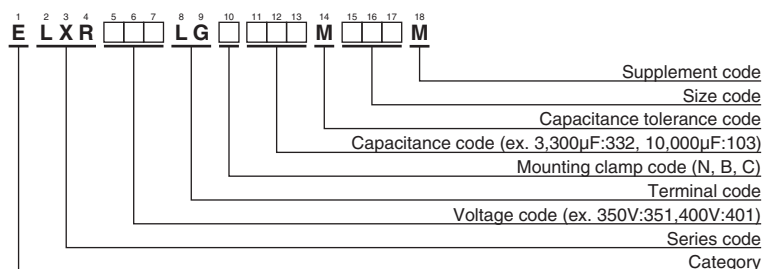

Please refer to "Product code guide (screw-mount terminal type)"

◆STANDARD RATINGS

WV (Vdc)	Cap (μF)	Case size φD×L(mm)	tanδ	Rated ripple current (Arms/105°C,120Hz)	Part No.	WV (Vdc)	Cap (μF)	Case size φD×L(mm)	tanδ	Rated ripple current (Arms/105°C,120Hz)	Part No.	
350	3,300	63.5×115	0.15	14.4	ELXR351LGC332MDB5M	400	6,800	76.2×170	0.15	27.3	ELXR401LGC682MEH0M	
	3,900	63.5×130	0.15	16.6	ELXR351LGC392MDD0M		6,800	89×155	0.15	26.6	ELXR401LGC682MFF5M	
	4,700	63.5×155	0.15	19.8	ELXR351LGC472MDF5M		8,200	89×170	0.15	30.5	ELXR401LGC822MFH0M	
	4,700	76.2×115	0.15	19.1	ELXR351LGC472MEB5M		10,000	100×190	0.15	34.5	ELXR401LGC103MGK0M	
	5,600	63.5×170	0.15	22.5	ELXR351LGC562MDH0M		12,000	100×220	0.15	40.2	ELXR401LGC123MGN0M	
	5,600	76.2×130	0.15	21.9	ELXR351LGC562MED0M		450	2,200	63.5×115	0.15	11.8	ELXR451LGC222MDB5M
	6,800	76.2×155	0.15	26.2	ELXR351LGC682MEF5M			2,700	63.5×130	0.15	13.7	ELXR451LGC272MDD0M
	8,200	76.2×170	0.15	30.0	ELXR351LGC822MEH0M			2,700	76.2×115	0.15	14.5	ELXR451LGC272MEB5M
	8,200	89×155	0.15	29.2	ELXR351LGC822MFF5M			3,300	63.5×155	0.15	16.5	ELXR451LGC332MDF5M
	10,000	89×170	0.15	33.7	ELXR351LGC103MFH0M			3,300	76.2×130	0.15	16.9	ELXR451LGC332MED0M
	12,000	100×190	0.15	37.8	ELXR351LGC123MGK0M			3,900	63.5×170	0.15	18.7	ELXR451LGC392MDH0M
	15,000	100×250	0.15	47.7	ELXR351LGC153MGR0M			4,700	76.2×155	0.15	21.7	ELXR451LGC472MEF5M
400	2,700	63.5×115	0.15	13.1	ELXR401LGC272MDB5M	5,600		76.2×190	0.15	26.1	ELXR451LGC562MEK0M	
	3,300	63.5×130	0.15	15.2	ELXR401LGC332MDD0M	5,600		89×155	0.15	24.1	ELXR451LGC562MFF5M	
	3,900	63.5×155	0.15	17.9	ELXR401LGC392MDF5M	6,800		89×170	0.15	27.8	ELXR451LGC682MFH0M	
	3,900	76.2×115	0.15	18.2	ELXR401LGC392MEB5M	8,200		89×190	0.15	32.0	ELXR451LGC822MFK0M	
	4,700	63.5×170	0.15	20.5	ELXR401LGC472MDH0M	10,000		100×220	0.15	36.8	ELXR451LGC103MGN0M	
	4,700	76.2×130	0.15	20.1	ELXR401LGC472MED0M	12,000	100×250	0.15	42.7	ELXR451LGC123MGR0M		
	5,600	76.2×155	0.15	23.8	ELXR401LGC562MEF5M							

◆RATED RIPPLE CURRENT MULTIPLIERS

●Frequency Multipliers

Frequency (Hz)	120	300	1k	3k
Coefficient	1.0	1.1	1.3	1.4

The endurance of capacitors is reduced with internal heating produced by ripple current at the rate of halving the lifetime with every 5 to 10°C rise. When long life performance is required in actual use, the rms ripple current has to be reduced. Also, for the LXR series capacitors, using them at operating voltage less than their rated voltage can extend their lifetime. For details, please contact a representative of Nippon Chemi-Con.

RWV Series

- For frequently change of regenerative voltage from AC servo amplifier and inverter control
- Improved the resistance for charge and discharge from same dimension of RWF series
- Endurance with ripple current : 5,000 hours at 85°C
- Rated voltage range : 350 to 450V_{dc}, Capacitance 820 to 18,000μF
- RoHS Compliant



◆ SPECIFICATIONS

Items	Characteristics	
Category		
Temperature Range	-25 to +85°C	
Rated Voltage Range	350 to 450V _{dc}	
Capacitance Tolerance	±20% (M) (at 20°C, 120Hz)	
Leakage Current	I=0.02CV or 5mA, whichever is smaller. Where, I : Max. leakage current (μA), C : Nominal capacitance (μF), V : Rated voltage (V) (at 20°C after 5 minutes)	
Dissipation Factor (tanδ)	0.25 max. (at 20°C, 120Hz)	
Low Temperature Characteristics	Capacitance change $C(-25°C)/C(+20°C) \geq 0.7$ (at 120Hz)	
Insulation Resistance	When measured between the terminals shorted each other and the mounting clamp on the insulating sleeve covering the case by using an insulation resistance meter of 500V _{dc} , the insulation resistance shall not be less than 100MΩ.	
Insulation Withstanding Voltage	When a voltage of 2,000Vac is applied for 1 minute between the terminals shorted each other and the mounting clamp on the insulating sleeve covering the case, there shall not be electrical damage.	
Charge and Discharge	The following specifications shall be satisfied when the capacitors are restored to 20°C after subjected to charge and discharge test with the voltage waveform shown below at room temperature (15 to 35°C).	
	Capacitance change	≤±20% of the initial value
	D.F. (tanδ)	≤200% of the initial specified value
	Leakage current	≤The initial specified value
	Frequency	3Hz
	Number of cycles	50 million times
	Voltage waveform	
Endurance	The following specifications shall be satisfied when the capacitors are restored to 20°C after subjected to DC voltage with the rated ripple current is applied (the peak voltage shall not exceed the rated voltage) for 5,000 hours at 85°C.	
	Capacitance change	≤±20% of the initial value
	D.F. (tanδ)	≤200% of the initial specified value
	Leakage current	≤The initial specified value
Shelf Life	The following specifications shall be satisfied when the capacitors are restored to 20°C after exposing them for 500 hours at 85°C without voltage applied. Before the measurement, the capacitor shall be preconditioned by applying voltage according to Item 4.1 of JIS C 5101-4.	
	Capacitance change	≤±20% of the initial value
	D.F. (tanδ)	≤200% of the initial specified value
	Leakage current	≤The initial specified value

*Please consult with us about charge and discharge conditions.

◆ DIMENSIONS (Screw-Mount) [mm]

● Terminal Code : LG

Sleeve (Pb-free PVC : Black)

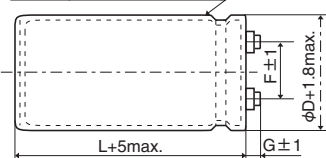

φ50 & φ63.5 : G=6
φ76.2 & φ89 : G=5

● Mounting Clamp Code : B

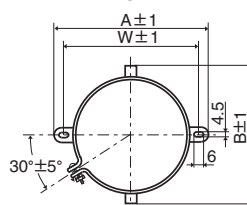

φD	A	B	W	F
50	78.0	64.0	68.0	22.4
63.5	90.0	76.0	80.0	28.0
76.2	104.5	90.0	93.5	31.5

● Mounting Clamp Code : C

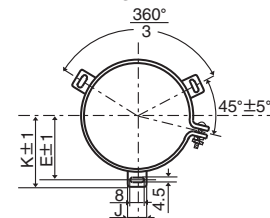

φD	E	K	F	J
50	32.5	37.0	22.4	14.0
63.5	38.1	43.5	28.0	14.0
76.2	44.5	50.0	31.5	14.0
89	50.8	56.5	31.5	16.0

<Screw specifications>

Plus hexagon-headed screw :M5×0.8×10

Maximum screw tightening torque :3.23Nm

* The screw and the mounting clamp are separately supplied and not attached to the product.

◆PART NUMBERING SYSTEM

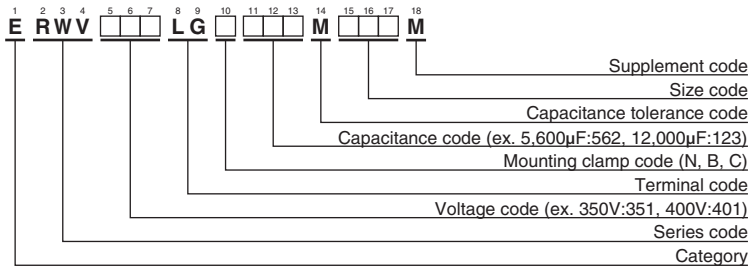

Please refer to "Product code guide (screw-mount terminal type)"

◆STANDARD RATINGS

WV (Vdc)	Cap (μF)	Case size φD×L(mm)	Rated ripple current (Arms/85°C,120Hz)	Max. charge current and Max. discharge current (Arms/3Hz)	Part No.	
350	1,200	50 × 60	4.70	1.56	ERWV351LGC122MC60M	
	1,500	50 × 70	5.50	1.83	ERWV351LGC152MC70M	
	1,800	50 × 80	6.40	2.13	ERWV351LGC182MC80M	
	2,200	50 × 96	7.60	2.53	ERWV351LGC222MC96M	
	2,700	50 × 105	8.80	2.94	ERWV351LGC272MCA5M	
	2,700	50 × 115	9.20	3.06	ERWV351LGC272MCB5M	
	3,300	50 × 130	10.8	3.58	ERWV351LGC332MCD0M	
	4,700	63.5 × 115	13.2	4.61	ERWV351LGC472MDB5M	
	5,600	63.5 × 130	15.2	5.30	ERWV351LGC562MDD0M	
	5,600	76.2 × 105	15.2	5.36	ERWV351LGC562MEA5M	
	6,800	63.5 × 155	18.1	6.32	ERWV351LGC682MDF5M	
	8,200	63.5 × 170	20.7	7.25	ERWV351LGC822MDH0M	
	8,200	76.2 × 130	20.2	6.57	ERWV351LGC822MED0M	
	10,000	76.2 × 155	24.2	8.47	ERWV351LGC103MEF5M	
	10,000	89 × 115	23.1	8.10	ERWV351LGC103MFB5M	
	12,000	76.2 × 170	27.6	9.66	ERWV351LGC123MEH0M	
	12,000	89 × 130	26.6	9.33	ERWV351LGC123MFD0M	
	15,000	89 × 155	32.1	11.2	ERWV351LGC153MFF5M	
15,000	89 × 170	33.5	11.7	ERWV351LGC153MFH0M		
18,000	89 × 190	38.5	13.5	ERWV351LGC183MFK0M		
375	1,000	50 × 60	4.30	1.42	ERWV3H1LGC102MC60M	
	1,200	50 × 70	4.90	1.64	ERWV3H1LGC122MC70M	
	1,500	50 × 80	5.80	1.94	ERWV3H1LGC152MC80M	
	2,200	50 × 96	7.60	2.54	ERWV3H1LGC222MC96M	
	2,200	50 × 105	8.00	2.65	ERWV3H1LGC222MCA5M	
	2,700	50 × 115	9.20	3.06	ERWV3H1LGC272MCB5M	
	3,300	50 × 130	10.8	3.58	ERWV3H1LGC332MCD0M	
	4,700	63.5 × 115	13.2	4.61	ERWV3H1LGC472MDB5M	
	5,600	63.5 × 130	15.2	5.30	ERWV3H1LGC562MDD0M	
	5,600	76.2 × 105	15.2	5.36	ERWV3H1LGC562MEA5M	
	6,800	63.5 × 155	18.1	6.32	ERWV3H1LGC682MDF5M	
	6,800	63.5 × 170	18.9	6.60	ERWV3H1LGC682MDH0M	
	8,200	76.2 × 130	20.2	7.09	ERWV3H1LGC822MED0M	
	8,200	89 × 115	20.9	7.35	ERWV3H1LGC822MFB5M	
	10,000	76.2 × 155	24.2	8.48	ERWV3H1LGC103MEF5M	
	10,000	76.2 × 170	25.2	8.85	ERWV3H1LGC103MEH0M	
	10,000	89 × 130	24.3	8.54	ERWV3H1LGC103MFD0M	
	12,000	89 × 155	28.7	10.0	ERWV3H1LGC123MFF5M	
15,000	89 × 170	33.5	11.7	ERWV3H1LGC153MFH0M		
15,000	89 × 190	35.2	12.3	ERWV3H1LGC153MFK0M		
400	1,000	50 × 60	4.30	1.42	ERWV401LGC102MC60M	
	1,200	50 × 70	4.90	1.64	ERWV401LGC122MC70M	
	1,500	50 × 80	5.80	1.95	ERWV401LGC152MC80M	
	1,800	50 × 96	6.90	2.29	ERWV401LGC182MC96M	
	2,200	50 × 105	8.00	2.65	ERWV401LGC222MCA5M	
	2,200	50 × 115	8.30	2.77	ERWV401LGC222MCB5M	
	2,700	50 × 130	9.80	3.23	ERWV401LGC272MCD0M	
	3,900	63.5 × 115	12.0	4.21	ERWV401LGC392MDB5M	
	4,700	63.5 × 130	13.9	4.86	ERWV401LGC472MDD0M	
	5,600	63.5 × 155	16.4	5.75	ERWV401LGC562MDF5M	
	400	5,600	63.5 × 170	17.1	5.99	ERWV401LGC562MDH0M
		5,600	76.2 × 105	15.2	5.35	ERWV401LGC562MEA5M
		6,800	76.2 × 130	18.4	6.47	ERWV401LGC682MED0M
		8,200	76.2 × 155	21.9	7.68	ERWV401LGC822MEF5M
		8,200	76.2 × 170	22.8	8.02	ERWV401LGC822MEH0M
		8,200	89 × 115	20.9	7.35	ERWV401LGC822MFB5M
		10,000	89 × 130	24.3	8.26	ERWV401LGC103MFD0M
		12,000	89 × 155	28.7	10.0	ERWV401LGC123MFF5M
12,000		89 × 170	29.9	10.5	ERWV401LGC123MFH0M	
15,000		89 × 190	35.2	12.3	ERWV401LGC153MFK0M	
420		820	50 × 60	3.80	1.29	ERWV421LGC821MC60M
		1,000	50 × 70	4.40	1.50	ERWV421LGC102MC70M
		1,200	50 × 80	5.20	1.75	ERWV421LGC122MC80M
		1,800	50 × 96	6.80	2.30	ERWV421LGC182MC96M
		1,800	50 × 105	7.10	2.40	ERWV421LGC182MCA5M
		2,200	50 × 115	8.20	2.77	ERWV421LGC222MCB5M
		2,700	50 × 130	9.60	3.25	ERWV421LGC272MCD0M
		3,300	63.5 × 115	11.0	3.87	ERWV421LGC322MFB5M
	3,900	63.5 × 130	12.7	4.44	ERWV421LGC392MDD0M	
	4,700	63.5 × 155	15.0	5.28	ERWV421LGC472MDF5M	
	4,700	76.2 × 105	13.9	4.92	ERWV421LGC472MEA5M	
	5,600	63.5 × 170	17.1	6.02	ERWV421LGC562MDH0M	
	5,600	76.2 × 130	16.6	5.90	ERWV421LGC562MED0M	
	6,800	76.2 × 155	19.8	7.02	ERWV421LGC682MEF5M	
	6,800	89 × 115	19.0	6.73	ERWV421LGC682MFB5M	
	8,200	76.2 × 170	22.7	8.04	ERWV421LGC822MEH0M	
	8,200	89 × 130	22.0	7.78	ERWV421LGC822MFD0M	
	10,000	89 × 155	26.2	9.24	ERWV421LGC103MFF5M	
12,000	89 × 170	29.9	10.5	ERWV421LGC123MFH0M		
12,000	89 × 190	31.5	11.0	ERWV421LGC123MFK0M		
450	820	50 × 60	3.80	1.29	ERWV451LGC821MC60M	
	1,000	50 × 70	4.40	1.50	ERWV451LGC102MC70M	
	1,200	50 × 80	5.20	1.74	ERWV451LGC122MC80M	
	1,500	50 × 96	6.20	2.10	ERWV451LGC152MC96M	
	1,800	50 × 105	7.10	2.41	ERWV451LGC182MCA5M	
	1,800	50 × 115	7.40	2.51	ERWV451LGC182MCB5M	
	2,200	50 × 130	8.70	2.93	ERWV451LGC222MCD0M	
	3,300	63.5 × 115	11.0	3.88	ERWV451LGC332MDB5M	
	3,900	63.5 × 130	12.7	4.44	ERWV451LGC392MDD0M	
	3,900	76.2 × 105	13.2	4.49	ERWV451LGC392MEA5M	
	4,700	63.5 × 155	15.0	5.27	ERWV451LGC472MDF5M	
	4,700	63.5 × 170	15.6	5.50	ERWV451LGC472MDH0M	
	5,600	76.2 × 130	16.6	5.88	ERWV451LGC562MED0M	
	6,800	76.2 × 155	19.8	7.04	ERWV451LGC682MEF5M	
	6,800	89 × 115	19.0	6.72	ERWV451LGC682MFB5M	
	8,200	76.2 × 170	22.7	7.97	ERWV451LGC822MEH0M	
	8,200	89 × 130	22.0	7.72	ERWV451LGC822MFD0M	
	10,000	89 × 155	26.2	9.22	ERWV451LGC103MFF5M	
10,000	89 × 170	27.3	9.66	ERWV451LGC103MFH0M		
12,000	89 × 190	31.5	11.1	ERWV451LGC123MFK0M		



RWV Series

◆ RATED RIPPLE CURRENT MULTIPLIERS

● Frequency Multipliers

Frequency (Hz)	50	120	300	1k	3k
Coefficient	0.8	1.0	1.1	1.3	1.4

Note : The endurance of capacitors is shortened with internal heating produced by ripple current at the rate of halving the lifetime with every 5 to 10°C rise. When long life performance is required in actual use, the rms ripple current has to be reduced. Also, for the RWV series capacitors, using them at operating voltage less than their rated voltage can extend their lifetime. For the details, please contact a representative of Nippon Chemi-Con.

Technical Note

— Judicious Use of Aluminum Electrolytic Capacitors —

Contents

1. Overview of Aluminum Electrolytic Capacitors

- 1 – 1 Basic Model of Aluminum Electrolytic Capacitors
- 1 – 2 Basic Structure of Aluminum Electrolytic Capacitors
- 1 – 3 Features of Capacitor Materials
- 1 – 4 Manufacturing process

2. Basic Performance

- 2 – 1 Basic Electrical Characteristics (capacitance, $\tan \delta$ and leakage current)
- 2 – 2 Frequency Characteristics of Impedance

3. Reliability

4. Failure Modes

5. Lifetime of Aluminum Electrolytic Capacitors

- 5 – 1 Ambient Temperature Effect on Lifetime
- 5 – 2 Applying Voltage Effect on Lifetime
- 5 – 3 Ripple Current Effect on Lifetime
- 5 – 4 Charge and Discharge Operation Effect on Lifetime
- 5 – 5 Inrush Current
- 5 – 6 Abnormal Voltage Effect on Lifetime

6. Effect of Halogens

- 6 – 1 Effect of Flux
- 6 – 2 Cleaning Agents
- 6 – 3 Adhesive and Coating Materials
- 6 – 4 Effect of Fumigation

7. Recovery Voltage Phenomena

8. Storage

9. Tips for Selecting Capacitors Appropriate for Individual Applications

- 9 – 1 Input Filtering Capacitors for Switching Mode Power Supplies
- 9 – 2 Output Filtering Capacitors for Switching Mode Power Supplies
- 9 – 3 Filtering Capacitors for Inverter Main Circuits
- 9 – 4 Capacitors for Control Circuits
- 9 – 5 Photoflash Capacitors

1. Overview of Aluminum Electrolytic Capacitors

1-1 Basic Model of Aluminum Electrolytic Capacitors

Capacitors are passive components. Among the various kinds of capacitors, aluminum electrolytic capacitors offer larger CV product per case size and lower cost than the others. In principles of capacitor, its fundamental model is shown in Fig. 1 and its capacitance (C) is expressed by Equation (1) below:

$$C = 8.854 \times 10^{-12} \frac{\epsilon S}{d} \text{ (F)} \dots\dots\dots(1)$$

- ϵ : Dielectric constant
- S : Surface area of dielectric (m²)
- d : Thickness of dielectric (m)

Equation (1) shows that the capacitance (C) increases as the dielectric constant (ϵ) and/or its surface area (S) increases and/or the dielectric thickness (d) decreases.

An aluminum electrolytic capacitor comprises a dielectric layer of aluminum oxide (Al₂O₃), the dielectric constant (ϵ) of which is 8 to 10. This value is not significantly larger than those of other types of capacitors.

However, by extending the surface area (S) of the aluminum foil electrode by means of etching, and by electrochemically forming a thinner but highly voltage-withstandable layer of oxide layer dielectric, the aluminum electrolytic capacitor can offer a larger CV product per case size than other types of capacitors.

A basic model of aluminum electrolytic capacitor is shown in Fig. 2. An aluminum electrolytic capacitor comprises:

- Anode ...Aluminum foil
- Dielectric...Electrochemically formed oxide layer (Al₂O₃) on the anode
- Cathode ...A true cathode is electrolytic solution (electrolyte).

Other component materials include a paper separator that holds electrolyte in place and another aluminum foil that functions as a draw-out electrode coming into contact with the true cathode (electrolyte).

In general, an aluminum electrolytic capacitor is asymmetrical in structure and polarized. The other capacitor type known as a bi-polar (non-polar) comprises the anodic aluminum foils for both electrodes.

1-2 Structure of Aluminum Electrolytic Capacitor

The aluminum electrolytic capacitor has, as shown in Fig. 3, a roll of anode foil, paper separator, cathode foil and electrode terminals (internal and external terminals) with the electrolyte impregnated, which is sealed in an aluminum can case with a sealing material.

The terminal draw-out structure, sealing material and structure differ depending on the type of the capacitor. Figure 4 shows typical examples.

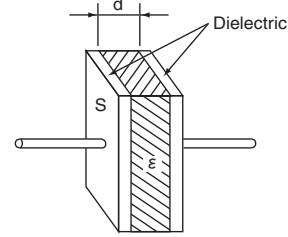
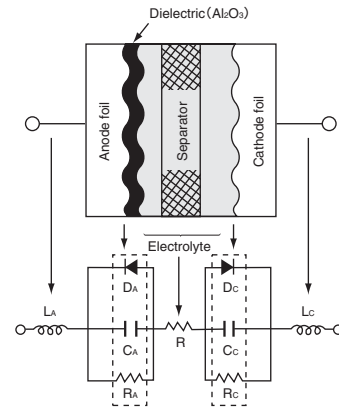

Fig-1 Basic model of capacitor



- C_A, C_C : Capacitance due to anode and cathodes foils
- D_A, D_C : Diode effects due to oxide layer on anode and cathode foils
- L_A, L_C : Inductance due to anode and cathode terminals
- R : Resistance of electrolyte and separator
- R_A, R_C : Internal resistance of oxide layer on anode and cathode foils

Fig-2 Basic model and equivalent circuit of aluminum electrolytic capacitor

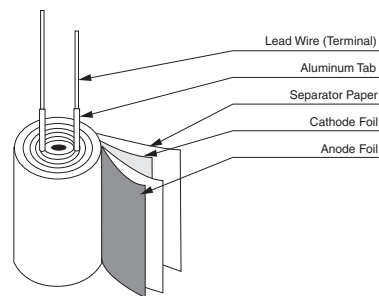

Fig-3 Basic model of element

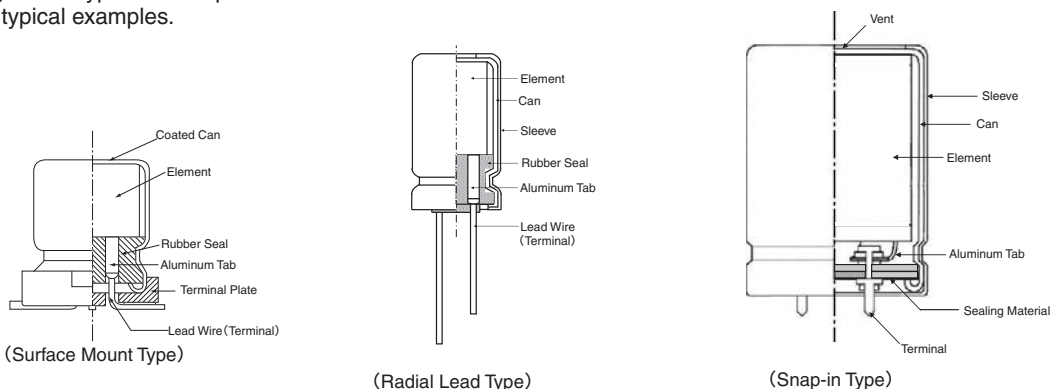

Fig-4 Construction of Aluminum Electrolytic Capacitors

1-3 Features of Capacitor Materials

Aluminum, which is main material in an aluminum electrolytic capacitor, forms an oxide layer (Al_2O_3) on its surface when the aluminum is set as anode and charged with electricity in electrolyte.

The aluminum foil with an oxide layer formed thereon, as shown in Fig. 5, is capable of rectifying electric current in electrolyte. Such a metal is called a valve metal.

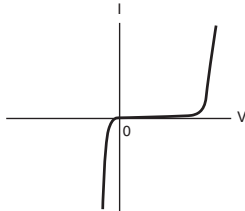

Fig-5 V-I characteristics of aluminum oxide

<Anode aluminum foil>

First, the foil material is electromechanically etched in a chloride solution to extend the surface area of the foil.

Secondly, for the foil to form an aluminum oxide layer (Al_2O_3) as a dielectric, more than the rated voltage is applied to the foil in a solution such as ammonium borate. This dielectric layer is as dense and thin as 1.1 - 1.5 nm/volt and showing a high insulation resistance ($10^8 - 10^9 \Omega/m$).

The thickness of the oxide layer determines the withstand voltage according to their direct proportional relationship. For the etching pits to be shaped to the intended thickness of the oxide layer, the pit patterns have been designed to have efficient surface area extension depending on the intended withstand voltage (see Fig. 6)

<Cathode aluminum foil>

An etching process is performed to the cathode aluminum foil as well as the anode foil. However, the formation process for oxide layer is generally not performed. Therefore, the surface of the cathode foil only has an oxide layer (Al_2O_3) that has spontaneously formed, which gives a withstand voltage of about 0.5 volt.

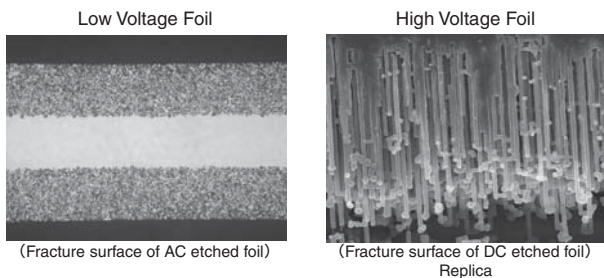

Fig-6 Cross section of aluminum etched foil (SEM)

<Electrolyte>

The electrolyte, an ion-conductive liquid functions as a true cathode coming into contact with the dielectric layer on the surface of the anode foil. The cathode foil serves as a collector electrode to connect the true cathode with the external circuit. Electrolyte is an essential material that controls the performance of the capacitor (temperature characteristics, frequency characteristics, service life, etc.).

<Paper separator >

The separator maintains uniform distribution of the electrolyte and keeps the anode-to-cathode foil distance unchanged.

<Can case and sealing materials>

An aluminum can case and seal materials mainly consisting of rubber are used for the purpose of keeping airtightness.

1-4 Manufacturing Process

① Etching (for extending the surface area)

This etching process serves to extend the surface area of the aluminum foil. This is an AC or DC current-employed electrochemical process for etching the foil surface in a chloride solution.

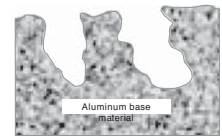

Etching Model

② Formation (for forming a dielectric)

This is a process for forming a dielectric layer (Al_2O_3), which is normally performed on the anode aluminum foil.

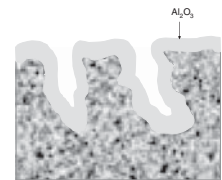

Forming Model

③ Slitting

This is a process for slitting aluminum foils (both the anode and cathode) and paper separators to the specified product size.

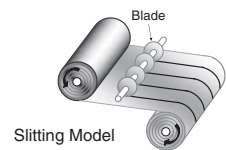

Slitting Model

④ Winding

This is a process for rolling a set of anode and cathode foils into a cylindrical form with a paper separator inserted between them. During this process, an inner terminal (called a tab) is attached to each of the aluminum foils. The roll made at this process is called a capacitor element.

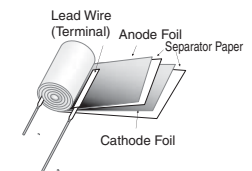

Winding Model

⑤ Impregnation

This is a process for impregnating the element with electrolyte as a true cathode. The electrolyte also functions to repair the dielectric layer.

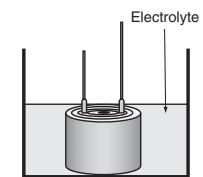

Impregnation Model

⑥ Sealing

This process seals the element using the aluminum can case and sealing materials (rubber, rubber-lined cover, etc.) for keeping the case airtight.

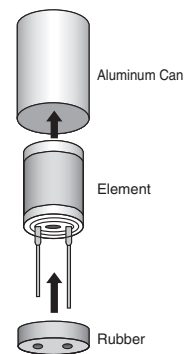

Sealing Model

⑦ Aging (reforming)

The process of applying voltage to a post-sealed capacitor at high temperature is called "aging". This serves to repair defective dielectrics that have been made on the foil during the slitting or winding process.

⑧ 100% inspection and packaging

After the aging, all products shall undergo testing for checking their electrical characteristics with chip termination, lead reforming, taping etc. finished, and then be packaged.

⑨ Outgoing inspections

Outgoing inspections are performed as per standard inspection procedures.

⑩ Shipment

2. Basic Performance

2-1 Basic Electrical Characteristics

2-1-1 Capacitance

The larger the surface area of an electrode is, the higher the capacitance (capacity for storing electricity) is. For aluminum electrolytic capacitors, the capacitance is measured under the standard measuring conditions of 20°C and a 120Hz AC signal of about 0.5V. Generally, as the temperature rises, the capacitance increases; as the temperature decreases, the capacitance decreases (Fig. 7). With a higher frequency, the capacitance is smaller; with a lower frequency, the capacitance is larger (Fig. 8).

2-1-2 $\tan \delta$ (also called tangent of loss angle or dissipation factor)

(Fig. 9) is a simplified model of the equivalent circuit shown in (Fig. 2). For an ideal capacitor with an equivalent series resistance of $R = 0$, the $\tan \delta$ shown in (Fig. 10) is zero. For an aluminum electrolytic capacitor, the equivalent series resistance (R) is not zero due to the presence of resistance of the electrolyte and paper separator and other contact resistances. $1/\omega C$ and R are correlated as shown in (Fig. 10) and Equation (2).

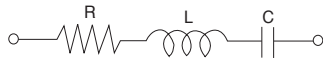

Fig-9 Simplified equivalent circuit

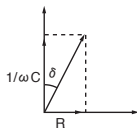

Fig-10 Dissipation Factor ($\tan \delta$)

$$\tan \delta = \frac{R}{1/\omega C} = \omega CR \dots\dots\dots (2)$$

$$\omega : 2\pi f$$

$$\pi = \text{Circular constant, } f : \text{Frequency (} f = 120\text{Hz)}$$

2-1-3 Leakage Current (LC)

As a feature of an aluminum electrolytic capacitor, when DC voltage is applied to it, the oxide layer that acts as a dielectric in the electrolyte allows a small amount of electric current to flow in it. The small amount of current is called a leakage current (LC). An ideal capacitor does not allow the leakage current to flow (this is not the case for charging current).

The leakage current (LC) changes with time as shown in (Fig. 12). Note that LC, decreasing with time, will reach a steady-state value. Therefore, the specifications of LC are defined as a value measured several minutes after the beginning of the application of the rated voltage at 20°C. As the temperature rises, the LC increases; as the temperature decreases, the LC decreases (Fig.13). As the applied voltage decreases, the LC decreases.

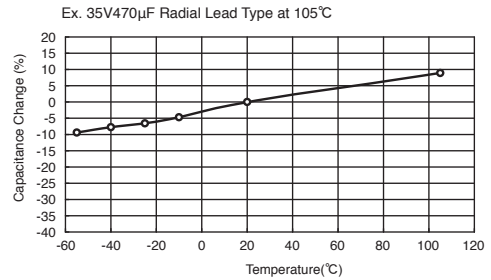

Fig-7 Temperature Characteristics of Capacitance

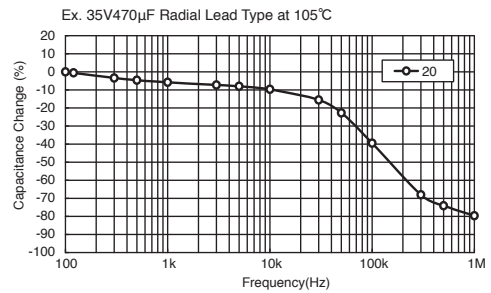

Fig-8 Frequency Characteristics of Capacitance

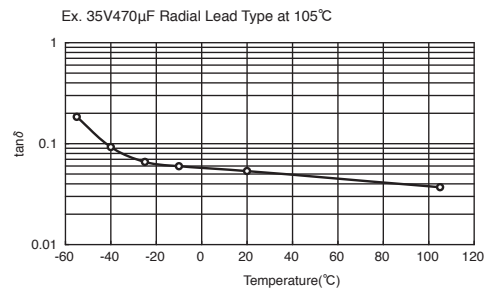

Fig-11 Temperature Characteristics of $\tan \delta$

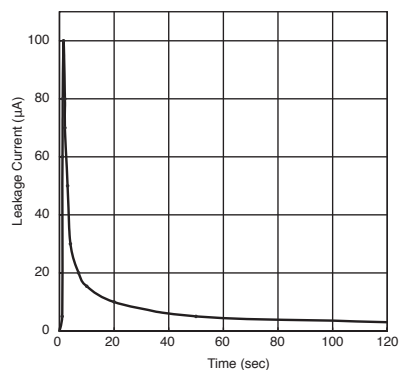

Fig-12 Leakage Current vs. Time

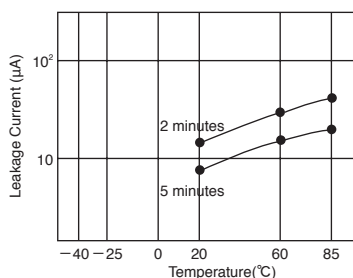

Fig-13 Temperature Characteristics of Leakage Current

2-2 Frequency Characteristics of Impedance (Z)

When a capacitor is applied with a voltage with the frequency changed, the impedance (Z), a factor of preventing the AC current changes as shown in (Fig. 14). This is the impedance-frequency characteristics of the capacitor.

(Fig. 9) is a simplified model of an equivalent circuit of an aluminum electrolyte capacitor. (Fig. 14) shows dotted lines representing a breakdown of the impedance-frequency characteristic curve into components (C, R and L). As can be seen in this figure, the impedance-frequency characteristics are a composition of C, R and L frequency characteristics.

The value $1/\omega C$ shows the pure capacitive reactance graphically presented by a straight line going downward at an angle of 45° , and ωL shows the pure inductive reactance graphically presented by a straight line going upward at 45° . R shows the equivalent series resistance (ESR). At a range of lower frequencies, the R curve goes downward due to the dielectric loss frequency-dependence. At a range of higher frequencies, the R curve tends to be almost flat since resistance of electrolyte and paper separator is dominant and independent on frequency. Equation (3) shows this tendency.

$$Z = \sqrt{R^2 + \left(\omega L - \frac{1}{\omega C}\right)^2} \dots\dots\dots (3)$$

Because the impedance characteristics of an aluminum electrolyte capacitor depend on resistance of the electrolyte and paper separator, the Z value at the self-resonant frequency tends to be relatively higher, as shown by the solid line in (Fig. 15). The resistance of the electrolyte varies depending on temperature: as the temperature rises, the impedance decreases; and as the temperature decreases, the impedance increases, as shown in (Fig. 16).

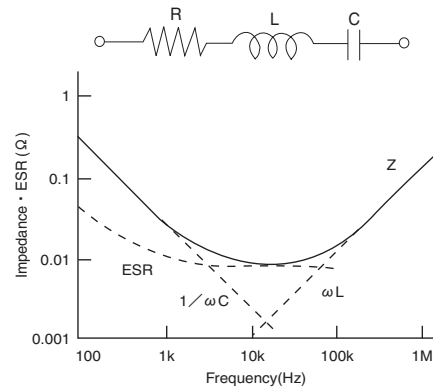

Fig-14 Factor of Impedance Frequency

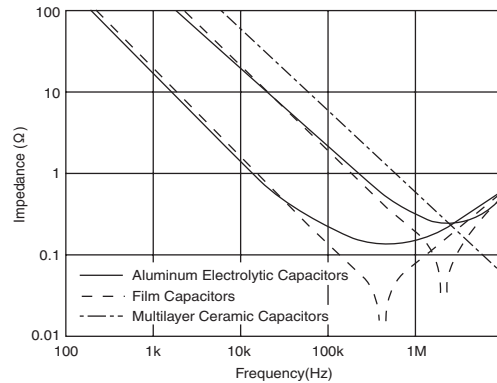

Fig-15 Frequency Characteristics of each Capacitors Impedance

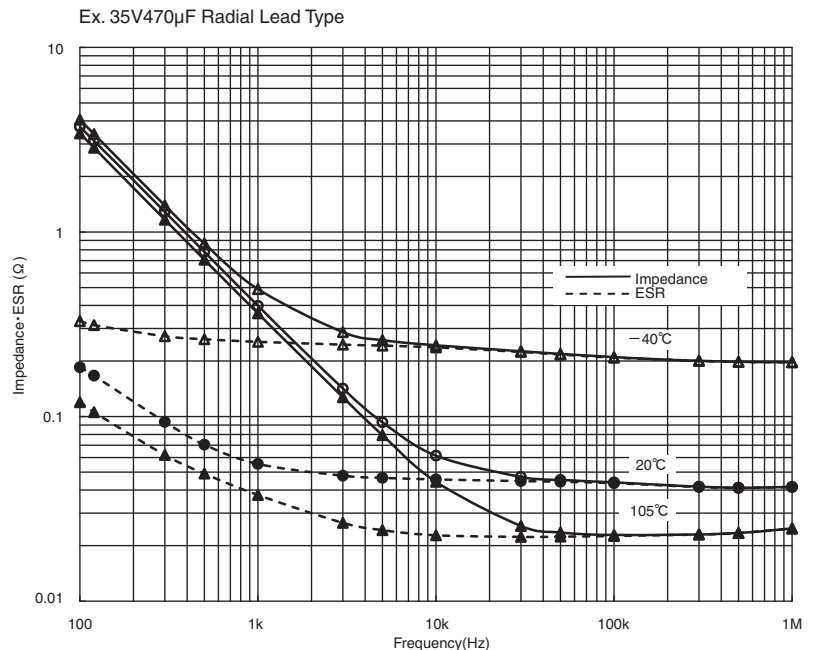

Fig-16 Temperature and Frequency Characteristics of Impedance · ESR

3. Reliability

For designing the device with aluminum electrolytic capacitors, a failure rate and useful life are necessary to be considered for their reliability. The failure rate of aluminum electrolytic capacitors is approximated by the bathtub curve shown in (Fig.17).

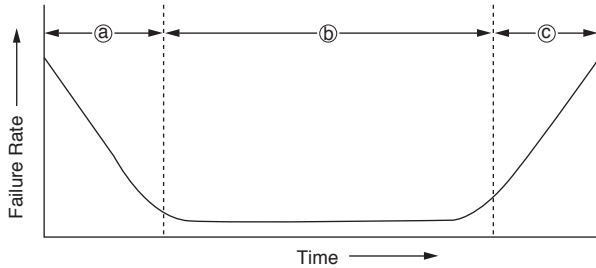

Fig-17 Bathtub curve

- (a) **Early failure period**
At the comparatively early periods of use, devices/components fail by deficiencies in design or manufacturing process or incompatibility with operation conditions. For aluminum electrolytic capacitors, these defectives are removed by debugging at one of manufacturing processes before shipments.
- (b) **Random failure period**
Failure is stable low in occurrence and appears unrelated to their served term. Aluminum electrolytic capacitors are low in catastrophic failures in this period compared with semi-conductors and solid tantalum capacitors.
- (c) **Wear-out failure period**
In this period, the failure rate increases with the served time. For aluminum electrolytic capacitors, since they were completed in manufacturing, the electrolyte impregnated has gradually evaporated and diffused out of the capacitors through the rubber seal materials with time, which leads to decrease in the capacitance and/or increase $\tan\delta$. When any of these values changes beyond the allowable range of specifications, the capacitors are defined as "fell into the wear-out failure". The served term until the capacitors fall into the wear-out failure period is called a useful life.

Aluminum electrolytic capacitors have two categories of failures: catastrophic failure and wear-out failure.

<Catastrophic failure>

This is a failure mode that completely destroys the function of the capacitor such as short circuit and open circuit failure.

<Wear-out failure>

This is a failure mode where the electrical parameters of the capacitor gradually deteriorate and fail. The criteria for determining if this failure has occurred depend on the purpose of a device. For each series of capacitors, the following electrical parameters have been defined as criteria in the specifications of Endurance in the catalogs or product specifications:

- Change in capacitance
- $\tan\delta$
- Leakage current

Failure rates are often measured in units of % per 1000 hours ($10^{-5}/\text{hour}$). For higher reliability devices designed with a smaller failure rate, units of Failure In Time (FIT) ($10^{-9}/\text{hour}$) is used.

Aluminum electrolytic capacitors are considered as components of wear-out failure mode, the electrical characteristics of which gradually deteriorate and their failure rate increases with time. In general, the failure rate in FIT is determined by total component-hours (product of the number of tested components and test hours).

Due to the definition of FIT, the same FIT rate can be calculated in both cases of testing on the large number of tested components and also testing for long test periods of time. However, these cases mean differently for aluminum electrolytic capacitors. Using the failure rate is not suited to express the reliability of aluminum electrolytic capacitors, but the electrical characteristics based lifetime in hour should be considered to express the reliability.

Also, there are MTBF (Mean Time Between Failures) and MTTF (Mean Time To Failure) to express reliability. The latter is applicable for aluminum electrolytic capacitors because they are categorized into a group of non-repairable systems, equipment and devices for which MTTF is applicable.

4. Failure Modes

Failure modes depend on the application conditions that lead to fail. (Fig. 18).

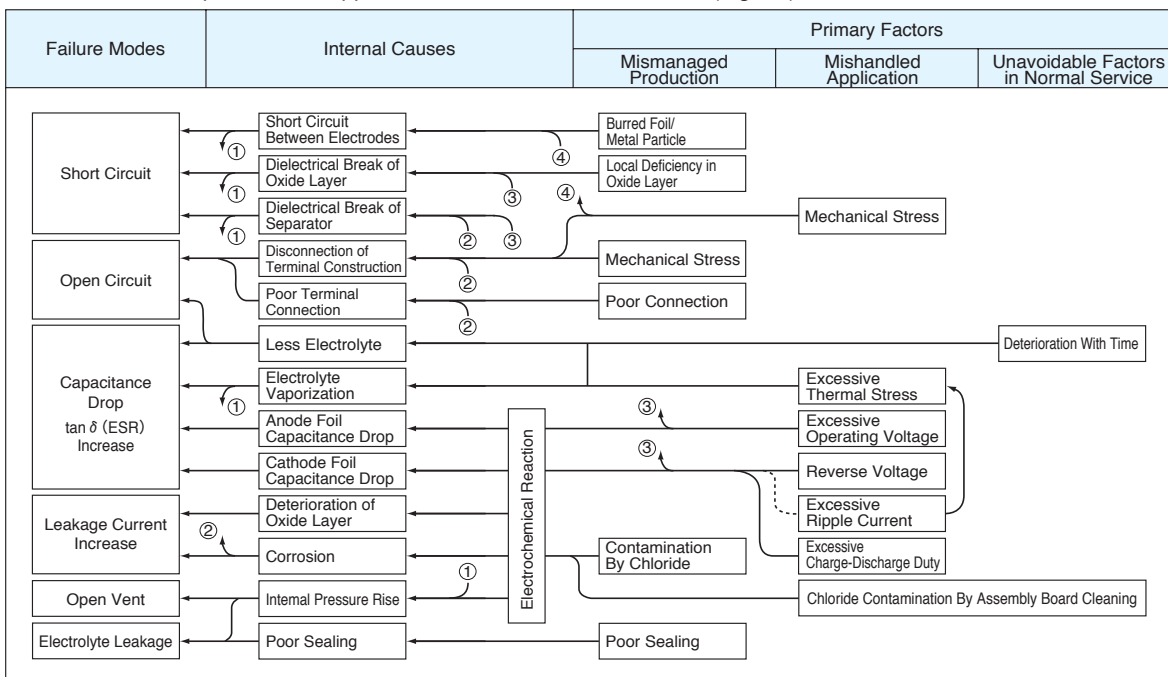

Fig-18 Failure Modes

5. Lifetime

The lifetime of aluminum electrolytic capacitors is largely dependent on the application conditions. Environmental factors include temperature, humidity, atmospheric pressure and vibrations. Electrical factors include operating voltage, ripple current and charge-discharge. Where the capacitors are used in a normal filtering circuit, ambient temperature and heating due to the ripple current are crucial factors for determining the lifetime of the capacitors. These factors are included to the lifetime specifications titled "Endurance" on the catalogs or product specifications. For applications subject to high humidity and/or continuous vibrations, or subject to frequent charge and discharge operations, the endurance of individual conditions should be considered.

5-1 Ambient Temperature Effect on Lifetime

The lifetime of aluminum electrolytic capacitors is affected mainly by the loss of electrolyte as the result of diffusion through the rubber seal materials, which leads to a decrease in capacitance and increase in $\tan \delta$.

The relationship of temperature to the diffusion of electrolyte follows the Arrhenius' Law (Equations (4) and (5)):

$$k = Ae^{\frac{-E}{RT}} \dots\dots\dots (4)$$

$$\ln k = \left(\frac{-E}{RT} \right) + \ln A \dots\dots\dots (5)$$

- k : Reaction rate constant
- A : Frequency factor
- E : Activation energy
- R : Gas constant (8.31J/deg)
- T : Absolute temperature (K)

Applying Equation (5) to the lifetime of the capacitors brings Equation (6), which is converted to Equation (7):

$$\log \left(\frac{L_x}{L_o} \right) = \frac{E}{2.303R} \left(\frac{1}{T_x} - \frac{1}{T_o} \right) \dots\dots\dots (6)$$

$$\log L_x = \frac{E}{2.303R} \left(\frac{1}{T_x} - \frac{1}{T_o} \right) + \log L_o \dots\dots\dots (7)$$

Practical estimation of the lifetime has been using Equation (8) as an approximation:

$$L_x = L_o \cdot Bt^{(T_o - T_x)/10} \dots\dots\dots (8)$$

- L_o : Specified lifetime (hour) with the rated voltage applied (or the rated ripple current superimposed to a DC voltage) at the upper limit of the category temperature. Refer to the lifetime specifications of individual products.
- L_x : Estimated life on actual usage (hour)
- T_o : Maximum Category Temperature (°C)
- T_x : Actual Ambient Temperature (°C)
- Bt : Temperature acceleration factor

Where, the temperature acceleration factor (BT) is approximately 2 over an ambient temperature range from 60°C to 95°C, which means that the lifetime is approximately halved for every 10°C rise in ambient temperature. However, according to the Arrhenius Equation (6), the reciprocal of T is directly proportional to the logarithm of lifetime, which means that, strictly speaking, there is the temperature range where the theory of lifetime reducing by half at every 10°C rise is not applied. (Fig. 19).

Especially for capacitors whose maximum operating temperature is a 105°C or higher, the temperature acceleration factor (BT) needs to be modified depending on temperature ranges of the lifetime estimation. For details, please consult us.

For lifetime estimation at a lower-temperature range, evaluation test data have not been obtained, and for evaluating long term endurance, it is necessary to take into account some additional factors such as deterioration of the rubber seal materials as well as the diffusion of electrolyte. Accordingly, in Equation (8), T_x should be 40°C at the lowest for the lifetime calculation purpose, and also the estimated lifetime (L_x) should be 15 years at the longest.

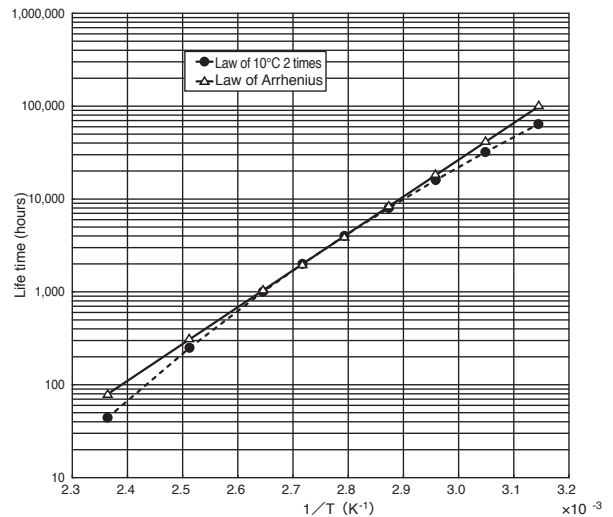

Fig-19 Estimated result by Law of 10°C 2 times and Law of Arrhenius

5-2 Applying Voltage Effect on Lifetime

Where a capacitor is used at lower than the rated voltage, the lifetime may not be adversely affected, which means that the effect of the applying voltage is negligibly small, while the effect of the ambient temperature and heat generation due to ripple current is significant.

(Fig-20)

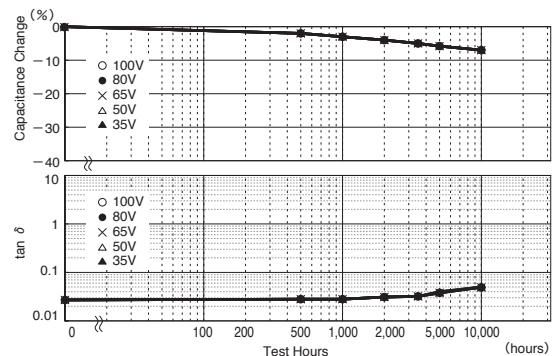

Fig-20 Endurance (measured by each apply voltage, result curves are overlapped)
Note: Due to the very small effect of the applying voltages, the plots cannot be distinguished from one another.

However, for capacitors of larger size and higher rated voltage contain a larger volume of electrolyte, difference in applying voltages can affect degradation of the oxide layer, other than the diffusion of electrolyte.

Therefore, for screw mount terminal type capacitors with the rated voltage of 350Vdc or higher, the lifetime estimation includes the effect of applying a lower voltage than the rated voltage (derating voltage).

5-3 Ripple Current Effect on Lifetime

Since an aluminum electrolytic capacitor has a larger $\tan\delta$ than other types of capacitors, the capacitor produces more internal heat when a ripple current flows through it. The temperature rise due to this heat may significantly affect the lifetime of the capacitor. This is the reason why ripple current ratings are specified for capacitors.

5-3-1 Heat Generation due to Ripple Current

Power consumption by the ripple current can be expressed as follows:

$$W = I_R^2 R + V I_L \dots\dots\dots (9)$$

- W : Internal power dissipation
- I_R : Ripple Current
- R : Internal Resistance (Equivalent Series Resistance)
- V : Applied voltage
- I_L : Leakage Current

Leakage current I_L at the maximum operating temperature can be 5 to 10 times higher than the values measured at 20°C. However, considering $I_R \gg I_L$, the above equation can be simplified as Equation (10).

$$W \approx I_R^2 R \dots\dots\dots (10)$$

To obtain the temperature at which equilibrium is achieved between heat generation and dissipation, derive Equation (11).

$$I_R^2 R = \beta A \Delta T \dots\dots\dots (11)$$

- β : Radiation Constant
- A : Surface area of can case (m^2)
- ΔT : Temperature-rise due to the Ripple Current ($^{\circ}C$)
- $A = \frac{\pi}{4} D (D + 4L)$
- D : Can Diameter (m)
- L : Can Length (m)

From the above equation, the internal temperature rise (ΔT) is given by Equation (12):

$$\Delta T = \frac{I_R^2 R}{\beta A} \dots\dots\dots (12)$$

Also, for a ripple frequency of 120Hz, Equation (12) for calculating ΔT is rewritten as Equation (13):

$$\Delta T = \frac{I_R^2 R}{\beta A} = \frac{I_R^2 \tan \delta}{\beta A \omega C} \dots\dots\dots (13)$$

Where $R = \frac{\tan \delta}{\omega C}$

- $\tan \delta$: Dissipation Factor at 120Hz
- ω : $2 \pi f$ ($f = 120Hz$)
- C : Capacitance at 120Hz(F)

An approximate value of ripple current-caused ΔT can be calculated using Equation (14):

$$\Delta T = (I_x/I_o)^2 \times \Delta T_o \dots\dots\dots (14)$$

- I_o : Rated ripple current (Arms), frequency compensated, at the upper limit of the category temperature range
- I_x : Operating ripple current (Arms) actually flowing in the capacitor
- ΔT_o : Rise in internal temperature due to the rated ripple current ($^{\circ}C$): different for each product series. Please consult us.

There are some product families that can accept a higher ripple current than the rated value providing that ambient temperature T_x is lower than the upper limit of the category temperature range. However, in this case, remember that the lifetime decreases due to the higher ΔT due to the ripple current. Be sure that ΔT does not exceed the specified limit that has been determined as a function of ambient temperature. Note that the core temperature limit of the element is shown by [$T_x + \Delta T$ limit].

Examples of ΔT limits at some ambient temperatures are shown below.

Ambient Temp T_x	85°C less or equal	105°C
Limit value of ΔT	15°C	5°C

Each product family has a different ΔT limit. For details, consult us.

5-3-2 Ripple Current and Frequency

The ripple current rating is specified normally by the effective value (r.m.s value) of 120Hz or 100kHz sine wave. However, since the equivalent series resistance (ESR) of a capacitor is frequency-dependent, the allowable ripple current depends on the frequency. Where the operating ripple current consists of a mains power frequency element and switching frequency element(s) like switching mode power supplies do, the internal power loss is expressed by Equation (15):

$$W = I_{f1}^2 R_{f1} + I_{f2}^2 R_{f2} + \dots\dots I_{fn}^2 R_{fn} \dots\dots\dots (15)$$

- W : Power consumption
- $I_{f1}, I_{f2}, \dots, I_{fn}$: Ripple current (Arms) at frequency $f1 \dots fn$
- $R_{f1}, R_{f2}, \dots, R_{fn}$: ESR (Ω) at $f1 \dots fn$

Given a frequency compensation factor (Frequency Multiplier) = F_{fn} and reference frequency for the ripple current = f_o , $R_{fn} = R_{f_o}/F_{fn}$ is obtained. Therefore, the ripple current at any frequency can be converted into its r.m.s. value at the reference frequency (I_{f_o}) using Equation (16):

$$I_{f_o} = \sqrt{(I_{f1}/F_{f1})^2 + (I_{f2}/F_{f2})^2 + \dots\dots (I_{fn}/F_{fn})^2} \dots\dots\dots (16)$$

- I_{f_o} : Reference ripple current (Arms), i.e., that at the reference frequency
- $F_{f1}, F_{f2}, \dots, F_{fn}$: Frequency compensation factor (Frequency Multiplier) at frequency $f1 \dots fn$ (Refer to the catalogs)

Note that the ESR depends on the temperature and the value of β depends on the installation conditions of the capacitor on the board. To determine more accurate values of ΔT , they can be actually measured using a thermocouple.

5-3-3 Lifetime Estimation

Equations (17) through (19) can be used for estimating the lifetime of a non-solid aluminum electrolytic capacitor based on the ambient temperature, the rise of internal temperature due to ripple current, and operating voltage applied.

For a capacitor whose Endurance specifications are defined by only "the DC rated voltage".

$$L_x = L_o \times 2^{\frac{T_o - T_x}{10}} \times 2^{\frac{-\Delta T}{5}} \dots\dots\dots (17)$$

For a capacitor whose Endurance specifications are defined by "the rated ripple current with a DC voltage superimposed".

$$L_x = L_r \times 2^{\frac{T_o - T_x}{10}} \times 2^{\frac{\Delta T_o - \Delta T}{5}} \dots\dots\dots (18)$$

For a screw terminal type capacitor with the rated voltage of 350Vdc or higher

$$L_x = L_r \times 2^{\frac{T_o + 5 - T_x - 25}{10}} \times 2^{\frac{25 - \Delta T}{A}} \times K_v \dots\dots\dots (19)$$

- L_o : Specified lifetime (hour) at the upper limit of the category temperature range and at the rated voltage
- L_r : Specified lifetime (hour) at the upper limit of the category temperature range and at the rated ripple current superimposed to a DC voltage
- L_x : Estimation of actual lifetime (hour)
- T_o : Upper limit of the category temperature range ($^{\circ}C$)
- T_x : Actual ambient temperature of the capacitor ($^{\circ}C$)
Use 40°C if the actual ambient temperature is below it.
- ΔT : Rise of internal temperature due to actual ripple current ($^{\circ}C$)
- * ΔT_o : Rise of internal temperature due to the rated ripple current ($^{\circ}C$)
- * A : This factor depends on the ripple frequency and internal temperature rise.
- K_v : Derating voltage factor

For the values marked with * , consult us.

Note that the calculation results above are not considered as a guaranteed value. When designing the lifetime of a device, please select a capacitor that has an extra margin against the device lifetime requirements. Also, where the estimation result calculated exceeds 15 years, please consider 15 years to be a maximum.

5-4 Charge and Discharge Operation Effect on Lifetime

Applying a voltage to an aluminum electrolytic capacitor makes the electric charges accumulate on the anode foil dielectric. Discharging the electricity through a discharging resistance makes the electric charges move to the cathode foil and cause chemical reactions between the cathode aluminum and electrolyte, thereby forming a dielectric oxide layer.

When this charge and discharge is repeatedly operated, the chemical reactions proceed to further form the oxide layer on the cathode foil, causing the capacitance of the cathode foil to reduce and thereby reducing the capacitance of the capacitor. Moreover, the chemical reactions bring heat and gases. Depending on the charge and discharge conditions, the internal pressure may increase, the pressure relief vent may open or the capacitor may have destructive failures. Consult us for using a capacitor with the following applications:

- Frequently repeating power on/off.
- Repeating rapid charge and discharge operations at a short interval cycle.
- Repeating charge and discharge operations with a large voltage drop.

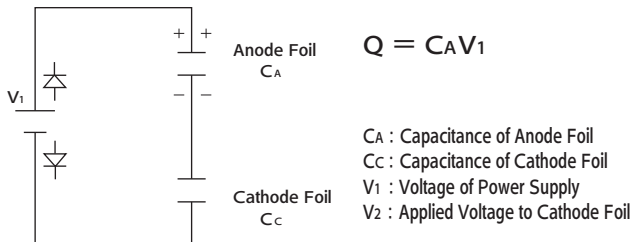

Fig-21 Charge Condition at Charge

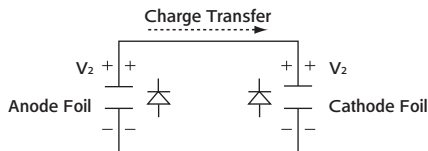

Fig-22 Charge Condition at Discharge (Disconnect V1 and Discharged condition)

$$Q = C_A V_2 + C_C V_2$$

$$\text{then } C_A V_1 = C_A V_2 + C_C V_2$$

$$V_2 = \frac{C_A V_1}{C_A + C_C} \dots\dots\dots (20)$$

Figures 23 through 25 show some test data of special-design capacitors for charge and discharge application, compared with general-purpose capacitors.

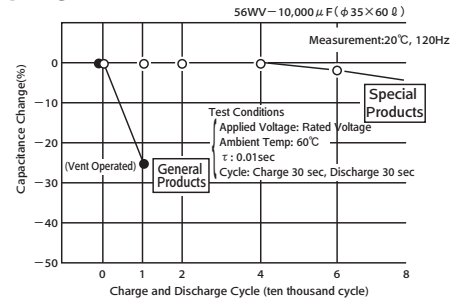

Fig-23 Rapid charge and discharge characteristics (Effects of Frequency)

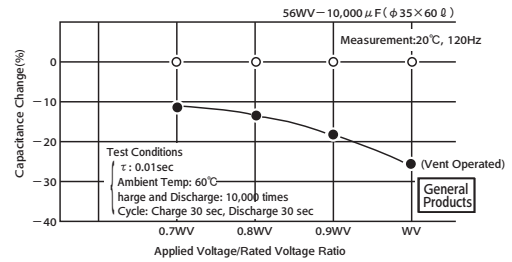

Fig-24 Rapid charge and discharge characteristics (Effects of Applied Voltage)

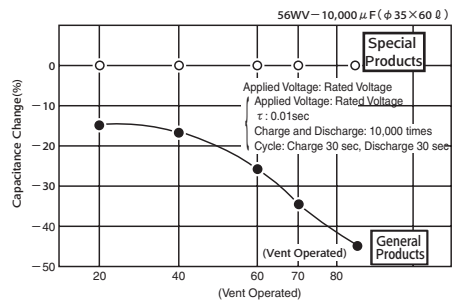

Fig-25 Rapid charge and discharge characteristics (Effects of Ambient Temperature)

5-5 Inrush Current

For the power supply inrush current that can occur on the start-up of a power supply or on the charge of a welding machine lasts only milliseconds, but its magnitude may reach 10 to 100 times more than the normal current. Usually, a single, non-repeated inrush current produces a negligibly small amount of heat, so it does not matter.

However, frequently repeating inrush currents may heat up the element inside a capacitor more than the allowable limit and/or overheat the external terminal connections or the connections between the internal lead and foil electrode.

5-6 Abnormal Voltage Effect on Lifetime

Applying abnormal voltage can increase the internal pressure with heat and gases produced, causing the pressure relief vent to open or the capacitor to have destructive failures.

5-6-1 Overvoltage

Applying a voltage higher than the rated voltage will cause chemical reactions (formation of dielectric) to occur on the anode foil with the leakage current rapidly increasing, which produces heat and gases and thereby increases the internal pressure.

The reactions are accelerated by the voltage, current density and ambient temperature, causing the pressure relief vent to open or the capacitor to have destructive failures. It may also accompany a reduction in capacitance and an increase in $\tan \delta$ as well as an increase in the leakage current, which can lead to internal short-circuiting failure. An example of capacitor overvoltage characteristics is shown in Fig. 26.

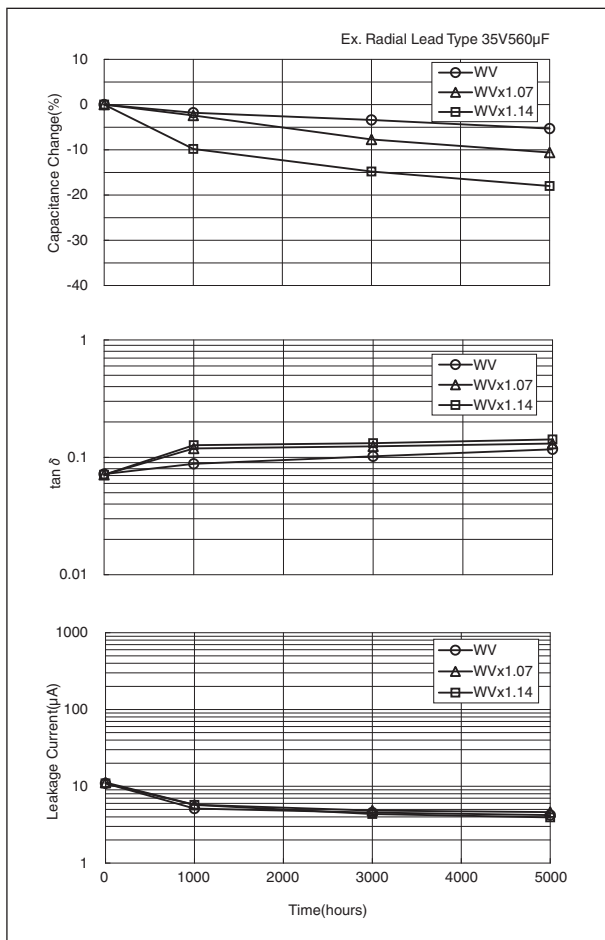

Fig-26 Applied overvoltage characteristic at 105°C

5-6-2 Reverse Voltage

Applying a reverse voltage will cause chemical reactions (formation of dielectric) to occur on the cathode foil, and, as is the case with overvoltage, the leakage current will rapidly increase with heat and gases generating and thus the internal pressure increases.

The reactions are accelerated by the voltage, current density and ambient temperature. It may also accompany a reduction in capacitance and an increase in $\tan \delta$ as well as an increase in the leakage current. An example of capacitor reverse-voltage characteristics is shown in Fig. 27.

A reverse voltage of as small as 1V can cause the capacitance to decrease. A reverse voltage of 2 to 3V can shorten lifetime due to a reduction in capacitance, increase in $\tan \delta$, and/or increase in leakage current. A reverse voltage of even higher value can open the pressure relief vent or lead to destructive failures (Fig. 27).

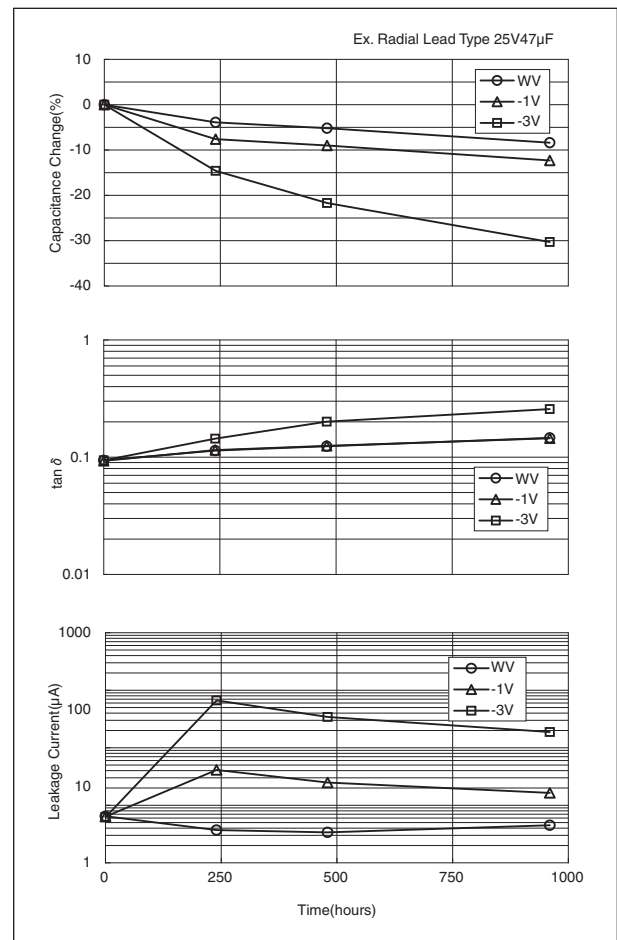

Fig-27 Applied Reverse voltage characteristic at 105°C

5-6-3 Do not Use Aluminum Electrolytic Capacitors in an AC Circuit

Using an aluminum electrolytic capacitor in an AC circuit will result in the same situation as that with a positive potential being applied to the cathode (like a reverse voltage) and with an excessively large ripple current flowing in the capacitor, which may increase the internal pressure due to the generation of heat and gases, open the pressure relief vent, leak the electrolyte with the rubber seal bung expelled or cause the capacitor to blow up or catch fire in the worst case. If the capacitor blows up, it may scatter flammable materials such as electrolyte and element-supporting wax materials, which can lead to short-circuiting of the device. Therefore, do not use aluminum electrolytic capacitors in any of the AC circuits.

6. Effect of Halogens

Aluminum electrolytic capacitors are sensitive to contamination of halogen ions (especially to chlorine and bromine ions) though the degree of the effect depends on the properties of the electrolyte and/or sealing materials used in the capacitors. For using a halide-containing flux, solvent (cleaning agent, adhesive or coating materials) or fumigant, the halide may penetrate into the capacitor through the rubber seal materials and cause the following corrosion reactions to occur. These reactions can lead to an increase in leakage current, opening of the pressure relief vent, and/or open-circuit failure in the capacitor. The reactions are accelerated as the voltage and/or temperature rises.

[Corrosion reactions]

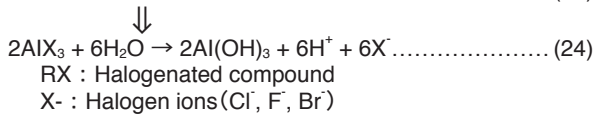
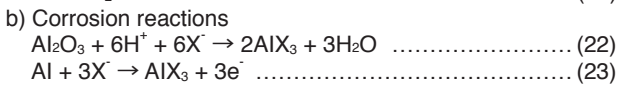
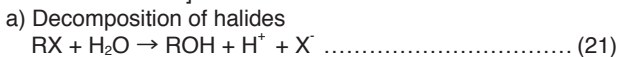

Halides that penetrated the element inside a capacitor make contact with the electrolyte, by which the halides are hydrolyzed and release halogen ions as shown on Reaction (21). The halogen ions then attack aluminum by anodic half-cell reaction, producing AlX₃ (Reaction 22 and 23).

AlX₃ is then hydrolyzed, which is decomposed to aluminum hydroxide and the halogen ions (Reaction (24)). The halogen ions reproduced are repeatedly used and reproduced by the reactions of (22) ~ (24), and then the corrosion develops endlessly.

Shown below are precautions for use of flux, cleaning agents, adhesive, coating materials and fumigant.

6-1 Effect of Flux

Usually flux products contain an activator of ionic halide system, which has been associated with the corrosion issues of capacitors, and nowadays non-ionic halide system type flux products have been increasingly available on the market. Some of the latter flux type have been classified into the so called "non-halogen flux" or "halogen-free flux", and parts of the "non-halogen" or "halogen-free" flux products may contain a large amount of non-ionic halides, which can also adversely affect the capacitors.

Flux types whose halogen ion concentrations are so low that the capacitor may not be adversely affected include:

- AHQ3100K (Asahi)
- POZ6 (Senjyu)

6-2 Cleaning Agents

6-2-1 Alcohol Cleaning Agents

- ① Fatty-alcohol cleaning agents (New type of solvent)
 Pine Alpha ST-100S (Arakawa Chemical)
 Clean Through 750H, 750K, 750L, and 710M (Kao)
 Technocare FRW-14 through 17 (GE Toshiba Silicones)
- ② IPA (Isopropyl alcohol)

[Compatible capacitor products]

Terminal Shape	Subject Series
Surface Mount Type	All Series
Radial Lead Type	All Series
Snap-in Type	All Series (Less and equal 100Vdc)

[Cleaning conditions]

Either of Immersion or ultrasonic cleaning, for a maximum of 10 minutes at a maximum liquid temperature of 60°C.

[Precautions]

- a. Make sure that the markings on a capacitor are not rubbed against any other component or the PC board during cleaning. Note that shower cleaning can cause the markings on the capacitor to be washed off.
- b. Depending on the cleaning method, the markings may be erased or blur.
- c. A drying process following a water cleaning or rinsing process may cause the outer sleeve materials of a capacitor to swell or shrink.
- d. After using a weak-alkaline cleaning agent (e.g. Clean Through 750H), rinse with water to make sure that no alkaline residue is left on the capacitor.
- e. Control a flux concentration in a cleaning agent within 2 wt%.
- f. IPS (Isopropyl Alcohol), if containing xylene or other solvent to improve its cleanability, may swell the rubber seal materials.
- g. Depending on the type of cleaning agent or conditions, note that the outer sleeve of a capacitor may lose a gloss or whiten in appearance.

6-2-2 HCFC (Freon-225), as Alternative CFCs

AK225AES (Asahi Glass)

[Cleaning conditions]

Solvent resistant type capacitors, which were originally developed to intend to resist Freon TE or Freon TES, are also capable of withstanding either of immersion or ultrasonic cleaning, for a maximum of 5 minutes (or 2 minutes for KRE and KRE-BP series capacitors or 3 minutes for SRM series). However, in view of global environmental issues, HCFCs has not been recommended.

[Compatible capacitor products]

Terminal Shape	Subject Series
Surface Mount Type	PXG, PXK, PXS, PXF, PXE, PXA, PXD, PXH, MVA(~63Vdc), MVE(~63Vdc), MZJ, MZA, MVY(6.3 ~ 63Vdc), MZF, MZE, MZK, MLA, MLF, MLE, MLK, MVL, MVJ, MVH(~50Vdc), MHB, MHJ, MV-BP, MVK-BP
Radial Lead Type	PSG, PSK, PSF, PSE, PSC, PSA, PS, SRM, KRE, KMA, SRG, KRG, KRE-BP, KMA-BP, KMQ(~100Vdc), SMG(~250Vdc), KMG(~250Vdc), SME-BP, KME-BP, LZA, LXZ, LXV, LXV, LE, FL, GPA, GXE(~50Vdc), GXL, GXH, LBG, LLA

When a capacitor is mounted closely flush on the PC board, a residual cleaning agent may be left in the gap between the body of the capacitor and PC board surface. Dry out the residue with a forced hot air of 50 to 85°C for 10 minutes or more.

6-2-3 Other Solvents

To avoid capacitor failures, do not use the following cleaning agents:

- Halogenated system: causes capacitor failures due to corrosion.
- Alkali system: corrodes (dissolves) the aluminum can case.
- Terpene and petroleum system: deteriorates the rubber seal materials.
- Xylene: deteriorates the rubber seal materials as well.
- Acetone: erases the markings printed on a capacitor.

6-3 Adhesive and Coating Material

To use adhesives and/or coating materials for aluminum electrolytic capacitors, make sure of the following conditions:

- a. Do not use any of adhesive or coating materials containing halogenated solvents.
- b. No flux residue nor stain is left between the rubber seal of a capacitor and PC board.
- c. Dry the capacitor to remove residual cleaning agents before applying adhesive and coating materials. Do not cover up the entire surface of the rubber seal of the capacitor with adhesive and coating materials.
- d. Improper heating and/or curing conditions for adhesives and coating materials may cause the sleeve to swell or shrink. Please consult us for proper conditions.

- e. For a non-solid aluminum electrolytic capacitor, covering up the entire surface of the rubber seal with resin mold materials will obstruct the normal diffusion of internal hydrogen gas from the capacitor and result in serious failures. Also, where the adhesive and coating materials contain a large amount of halogen ions, the halogen ions will contaminate the inside of the capacitor through the rubber seal materials, which cause the capacitor to become a failure.
- f. The outer sleeve of a capacitor may lose a gloss or whiten in appearance depending on solvent materials that the adhesive or coating materials contains.
- g. Some adhesives or coating materials contain organic solvent such as Xylene. Xylene can deteriorate the rubber seal materials, which cause the flux ingredients to penetrate into the capacitor.

7. Recovery Voltage

When a capacitor is once charged and discharged with both of the terminals short-circuiting and then left the terminals open for a while, a voltage across the capacitor spontaneously increases again. This is called "recovery voltage phenomenon". The mechanism for this phenomenon can be interpreted as follows:

When charged with a voltage, the dielectric produces some electrical changes within, and then the inside of the dielectric is electrified with the opposite polarities (dielectric polarization). The dielectric polarization occurs in both ways of proceeding rapidly and slowly. When a charged capacitor was discharged until the voltage across the capacitor disappears, and then being left the terminals open, the slow polarization will discharge within the capacitor and appear as recovery voltage. (Fig. 28).

The recovery voltage changes with time as shown in Fig. 29. Its peak will appear 10 to 20 days after the terminals are opened, with gradual weakening thereafter. Larger sized capacitors (screw terminal type and snap-in type) may produce larger recovery voltage.

With a recovery voltage residing in a capacitor, carelessly short-circuiting the terminals can cause sparks to occur, which may scare workers and/or damage low-voltage operating components such as CPU's and memories in the device circuit. To avoid this trouble, discharge the capacitor through 100 - 1kΩ resistors before use. Also, Nippon Chemi-Con may provide some solutions with some packaging method for it. Please consult us.

6-4 Effect of Fumigation

In exporting or importing electronic devices, they may be exposed to fumigation with halide such as methyl bromide. Where aluminum electrolytic capacitors exposed to halide such as methyl bromide, the capacitors will be damaged with the corrosion reaction with the halogen ions.

For the export and import, Nippon Chemi-Con considers using some packaging method and so forth that the fumigation is not required to. For customers to export or import electronic devices, semi-assembly products or capacitor components, confirm if they will be exposed to fumigation and also consider final condition of packaging. (Note that either cardboard or vinyl package has a risk of fumigation gas penetration.)

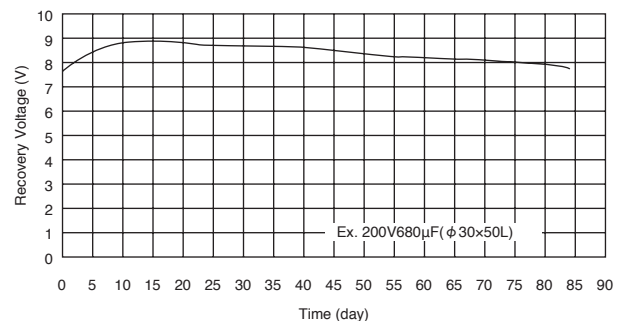
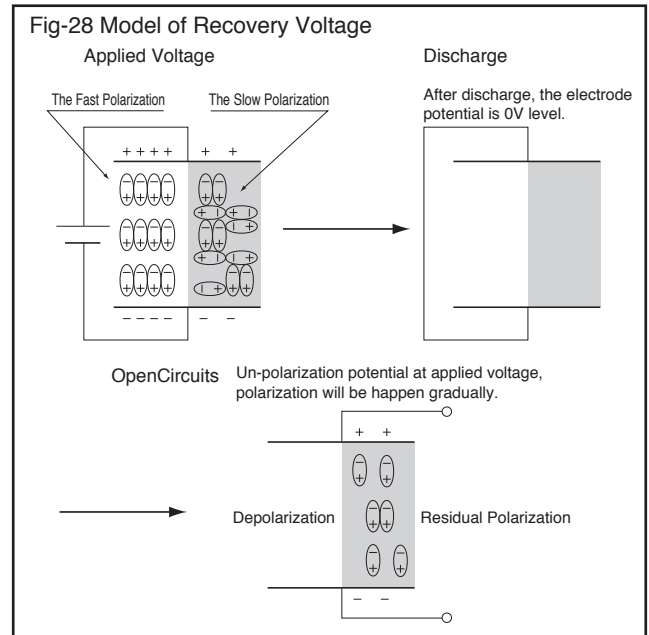

Fig-29 Change of Recovery Voltage

8. Storage

Some characteristics of an aluminum electrolytic capacitor are temperature-dependent. The higher the temperature is, the more deteriorated the capacitor will be. An increase in temperature accelerates the increase in leakage current and $\tan\delta$ and the decrease in capacitance. Leaving a capacitor exposed to high humidity for long hours may lead to discoloration of the lead wires and terminals, and poor solderability. To store aluminum electrolytic capacitors, keep them at normal temperature and humidity without exposure to direct sunlight.

Leaving them exposed to high temperatures (higher than the normal ambient temperature) may lead to chemical reactions between the anode oxide layer and electrolyte, which drop the withstanding voltage and increase leakage current. If this is the case, applying the rated voltage to the capacitor will lead to dielectric breakdown due to the heat produced with the large leakage current, which finally causes the pressure relief vent to open.

Capacitors that have been stored for long periods of time should be subjected to a voltage treatment process (see Note 1) which will reform the dielectric (Al_2O_3) by electrolyte and return the leakage current to the initial level. Leakage current increase during storage will vary with the withstanding voltage of a capacitor. In general, the higher the rated voltage, the larger increased the leakage current tends to be. Also, since storing for long period of time may shorten the lifetime of the capacitors, consider storage conditions according to the requirements of device life expectancy.

(Note 1) In the voltage treatment process, connecting resistor (around $1k\Omega$) in series with the capacitor, applied the rated voltage and then be kept the rated voltage for 30 to 60 minutes.

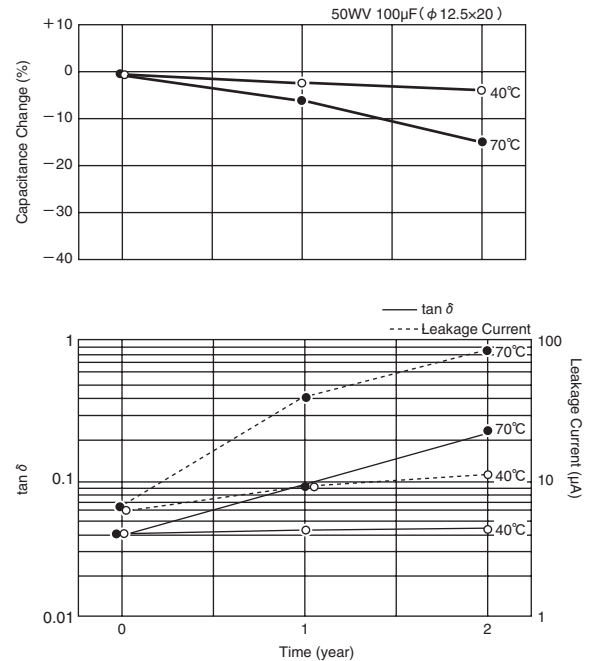

Fig-30 Temperature Characteristics of Storage

9. Tips for Selecting Capacitors Appropriate for Individual Applications

Aluminum electrolytic capacitors are used mainly for the filtering application of power supplies. Select appropriate capacitors for the specific requirements of each application, referring to the following examples for typical applications:

9-1 Input Filtering Capacitors for Switching Mode Power Supplies

An input filtering capacitor functions to smooth 50-120 Hz waveforms that come from a rectifying circuit, the waveforms of which are superimposed with the ripples with the switching frequency from the switching stage where the capacitor supplies the electric power. Therefore, the capacitor must be capable of managing both ripple currents with each frequency. The ESR of a capacitor is frequency-dependent, so that a ripple current of different frequency produces a different thermal energy in the capacitor.

For PFC power supplies or lighting ballasts, capacitors are subjected to ripple current whose frequency is several dozens of kHz to 100kHz. Therefore, to select capacitors, take their impedance characteristics into consideration.

● Recommended input filtering capacitors for SMPS

Characteristics Type	85°C		105°C		
	Standard	Longer Life	Standard	Compact	Longer Life
Radial Lead	—	—	KMG	PAG	KXJ
Snap-in	SMQ	SMM	KMQ	KMS, KMR	LXS, LXM

9-2 Output Filtering Capacitors for Switching Mode Power Supplies

In the output filtering, a capacitor must be capable of managing a ripple current with the frequency as high as around 100 kHz. Therefore, Nippon Chemi-Con provides excellent product line-ups with low impedance characteristic at high frequencies, including high temperature and long-life versions, which can be chosen according to the application purpose.

The 125°C maximum temperature series capacitors have a shorter lifetime than the “Long Life” series of 105°C max. temperature though the electrical characteristics are highly stable. The “wide temperature range” series has two subseries that differ by the applicable temperature range: -55 to 105°C and -40 to 125°C. The “Long Life” series capacitors have been designed for specializing lower impedance and also longer lifetime. Compared to the “wide temperature range” series, the Long Life series can serve longer with the lower impedance, though the maximum operating temperature is limited to 105°C and the electrical characteristics are large in change over the temperature range.

● Recommended output filtering capacitors for SMPS

Characteristics Type	105°C			125°C
	Standard	Low Z	Longer Life	High Temp
Wide Temp Range	LXY	LXZ	—	GXE
Longer Life	KY	KZH, KZE	KZM	—

9-3 Filtering Capacitors for Inverter Main Circuits

These capacitors are used in a similar way to those for the input of the switching mode power supplies. Additionally, please understand the following precautions:

For the filtering circuit for 400Vac line, two capacitors of each a rated voltage 350 to 400Vdc can be used with being connected in series. In the series connection, voltages across the individual capacitors during charging depend on their individual capacitance values. After completion of the charging, the voltages come to depend on their leakage current values as the voltage distribution to the individual capacitors inversely corresponds to their leakage current values. For the voltage not to exceed the rated value after the charging is completed, balancing resistors should be connected in parallel with each capacitor. For guidance on choosing balancing resistors, please consult us.

Where capacitors connected in series are frequently charged and discharged, individual charging voltages depend on the variations in their capacitance values. Therefore, keeping the voltage balance will be difficult even if balancing resistors are employed. For servo amplifiers and other application where the voltage fluctuates frequently due to regeneration, use capacitor families that have been especially designed for intensive charge and discharge operations, or consult us for individual designs.

● Recommended capacitors for inverter main circuits

Characteristics Type	85°C		105°C	
	Standard	Longer Life	Standard	Longer Life
Snap-in	SMQ	SMM	KMQ	LXS, LXM
Screw Mount	RWE	RWF, RWG	KMH	LXA, LXR

● Recommended capacitors for servo amplifiers

Characteristics Type	85°C	105°C
	Standard	High Temp
Snap-in	—	KMV
Screw Mount	RWV	—

9-4 Capacitors for Control Circuits

These capacitors are relatively small in capacitance, and therefore the case size is also small. However, the smaller the case size, the shorter the lifetime of a capacitor. Moreover, if a capacitor is located near a heat source, the capacitor's lifetime may be shortened. Consider selecting an adequate capacitor in lifetime balancing with other capacitors.

● Recommended capacitors for control circuits

Characteristics Type	105°C	
	5L, 7L	11L
Radial Lead	FL	KY

9-5 Photoflash Capacitors

These capacitors are specially designed so that much higher energy-volumetric efficiency can be obtained. Therefore, these capacitors are limited in application. Note that they cannot substitute filtering capacitors. Detailed specifications of these capacitors should be determined specifically for each photoflash application through discussions with a customer.

Reliability Test Data

MVL Series

MVH Series

●105°C Endurance

- MVL 6.3V 22μF D60
- △ MVL 50V 4.7μF E60
- × MVL 16V 47μF E60

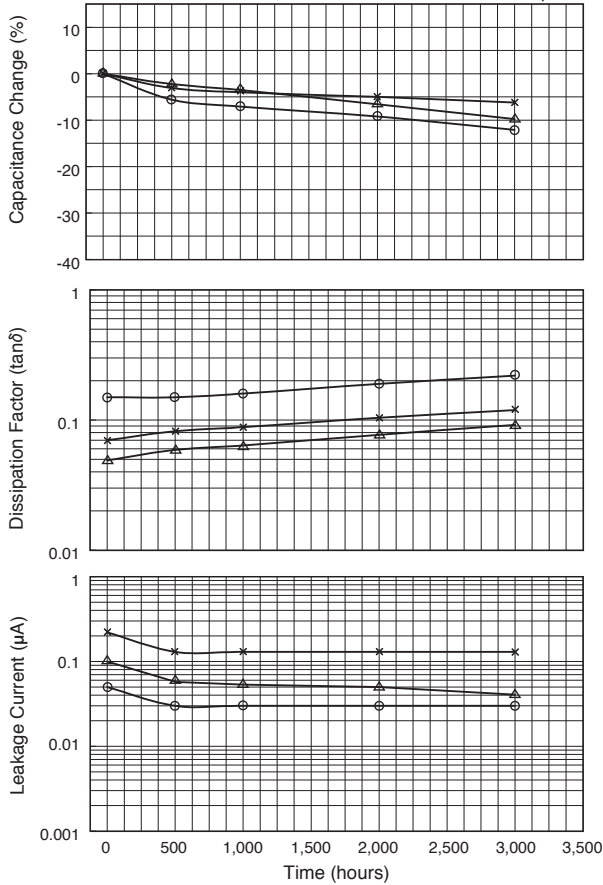

●125°C Endurance

- MVH 10V 220μF HA0
- △ MVH 35V 47μF HA0
- × MVH 50V 33μF HA0

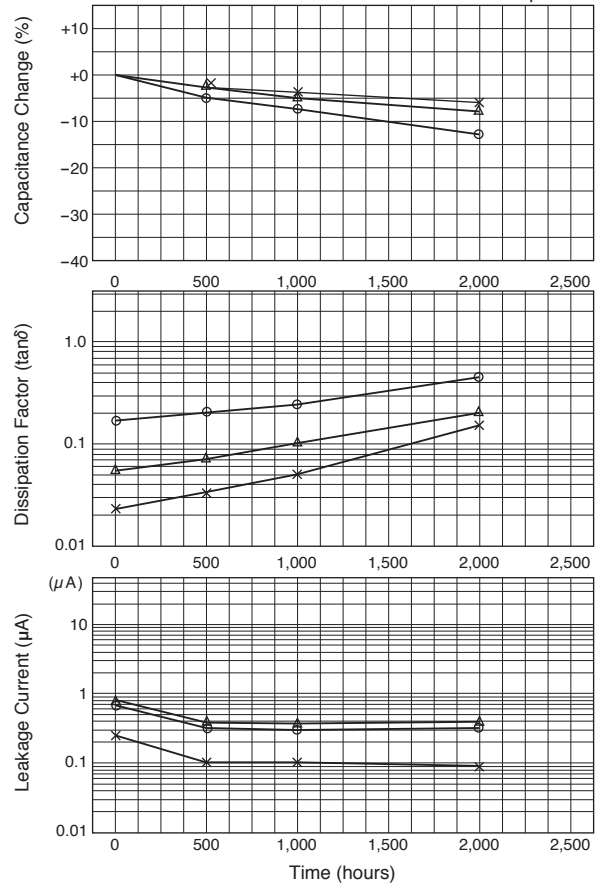

MVY Series

●Impedance/ESR vs Frequency

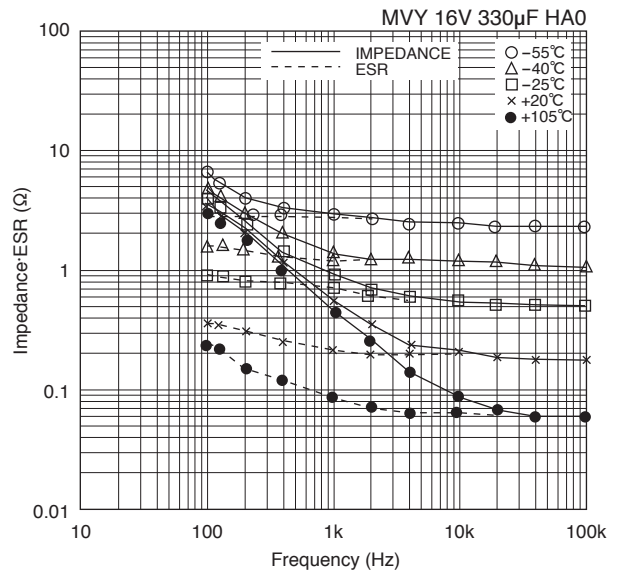
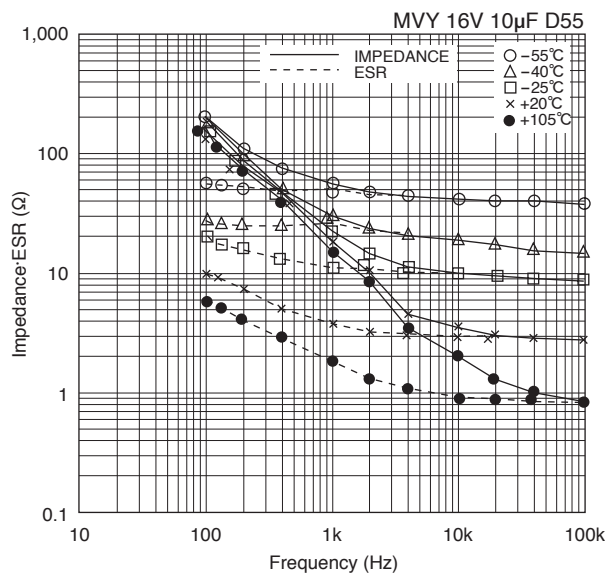

●105°C Endurance with Rated Ripple Current

○KZE 10V 220μF φ6.3×11L
 △KZE 16V 680μF φ10×16L
 □KZE 50V 470μF φ12.5×20L

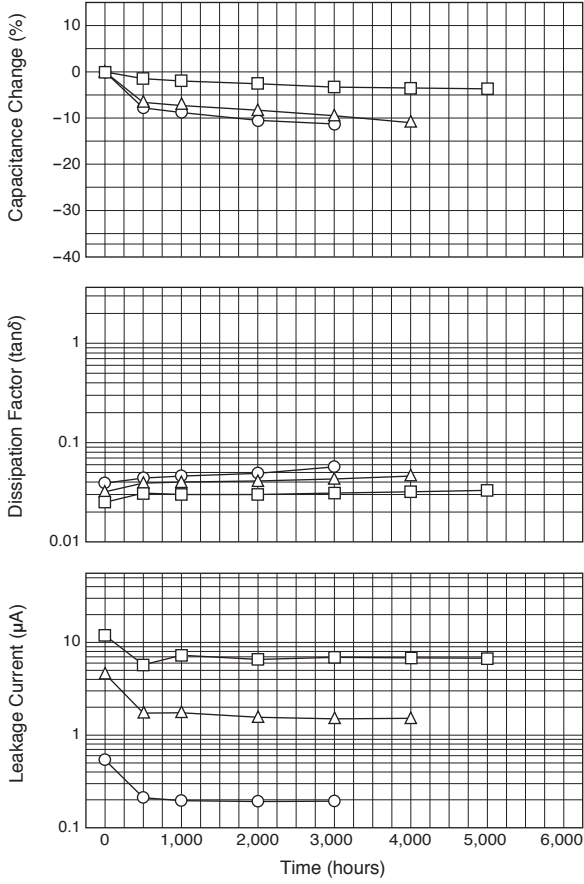

●105°C Shelf Life

○KZE 10V 220μF φ6.3×11L
 △KZE 16V 680μF φ10×16L
 □KZE 50V 470μF φ12.5×20L

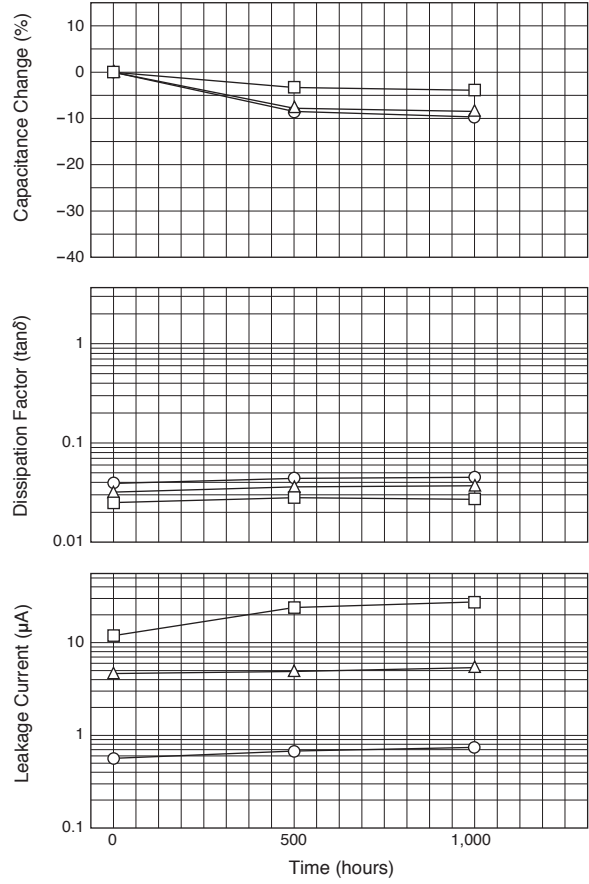

●Impedance-Frequency Characteristics

○KZE 10V 220μF φ6.3×11L
 △KZE 16V 680μF φ10×16L
 □KZE 50V 470μF φ12.5×20L at 20°C

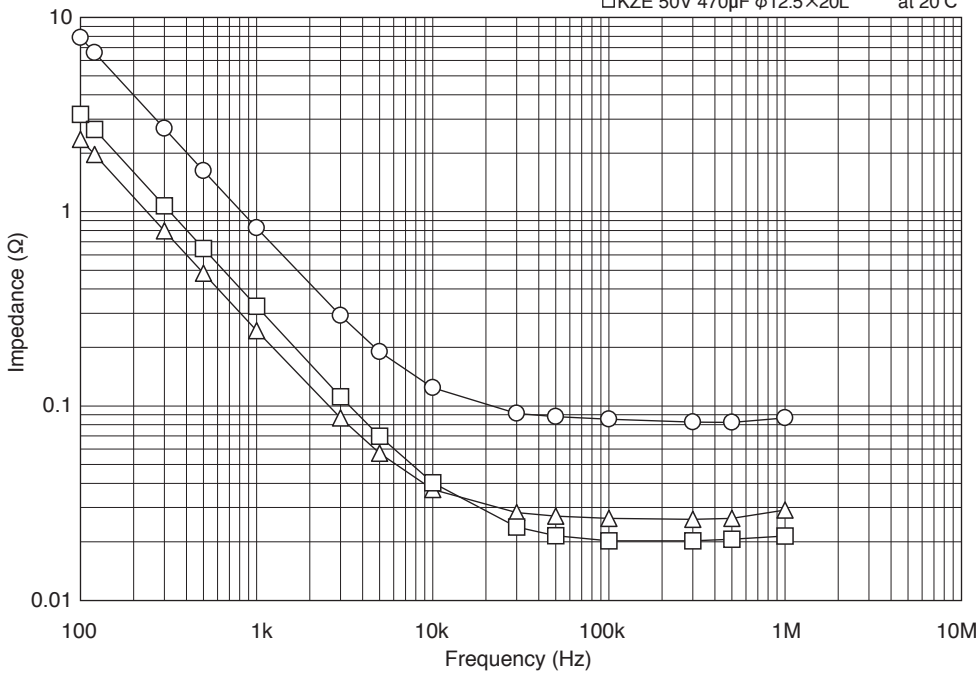

LXZ Series

LXY Series

●105°C Endurance with Rated Ripple Current

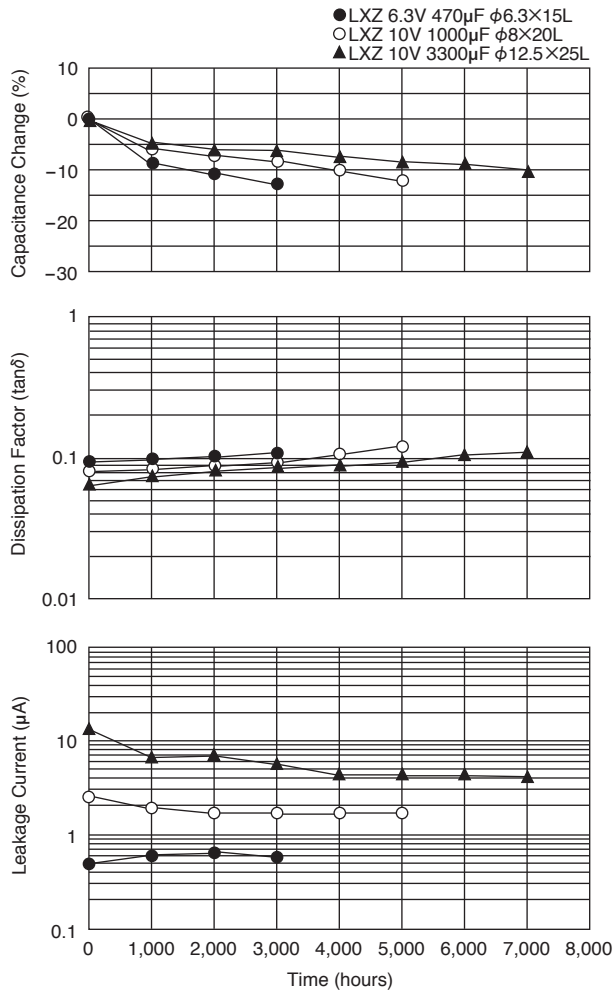

●105°C Endurance with Rated Ripple Current

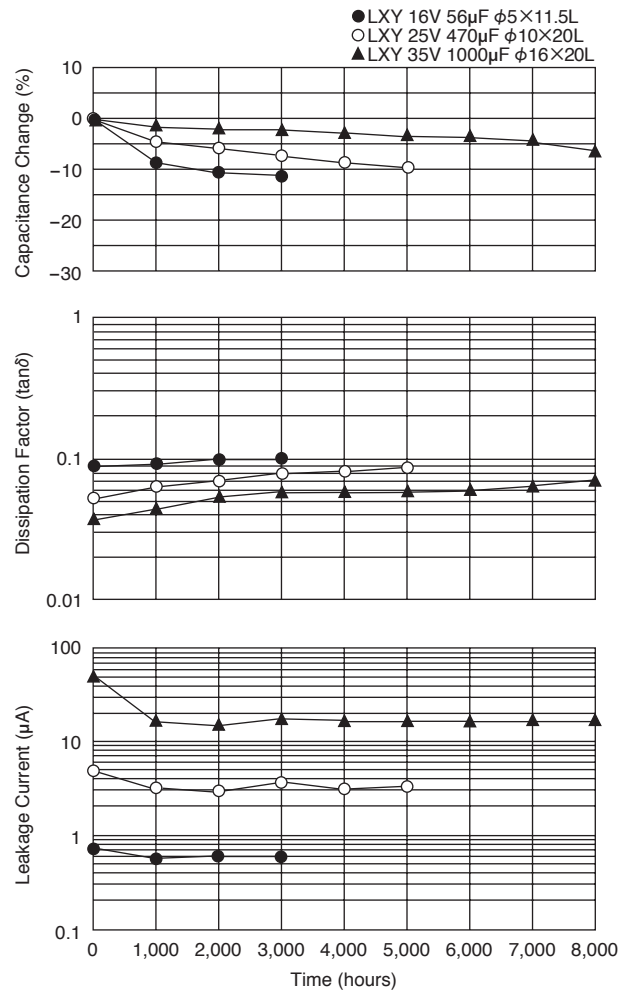

●Impedance-Frequency Characteristics

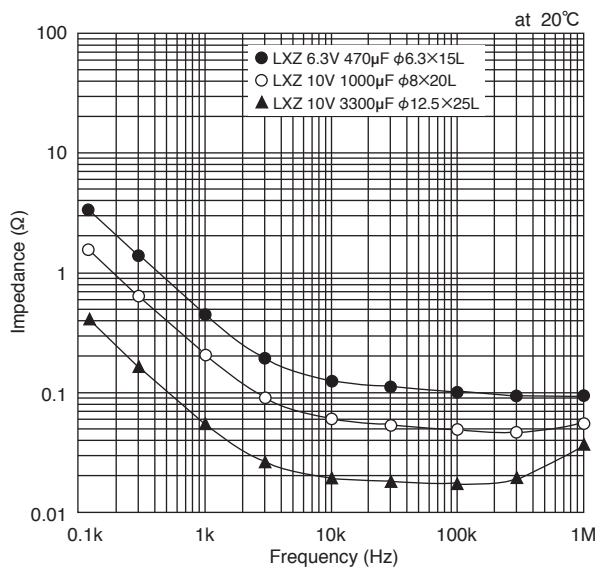

●Impedance-Frequency Characteristics

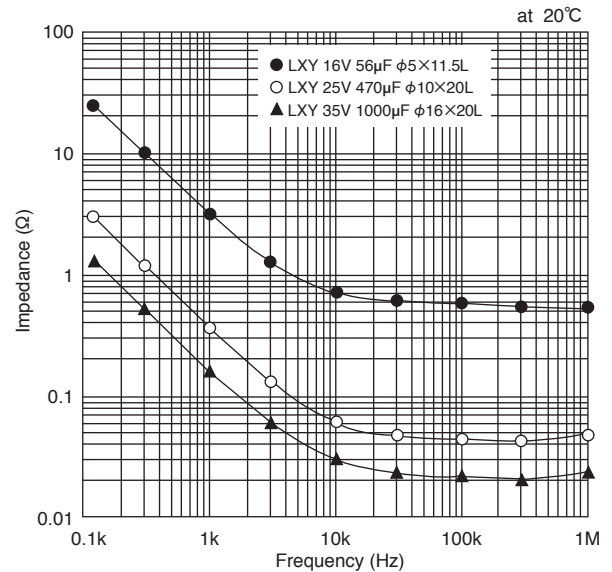

●105°C Endurance with Rated Ripple Current

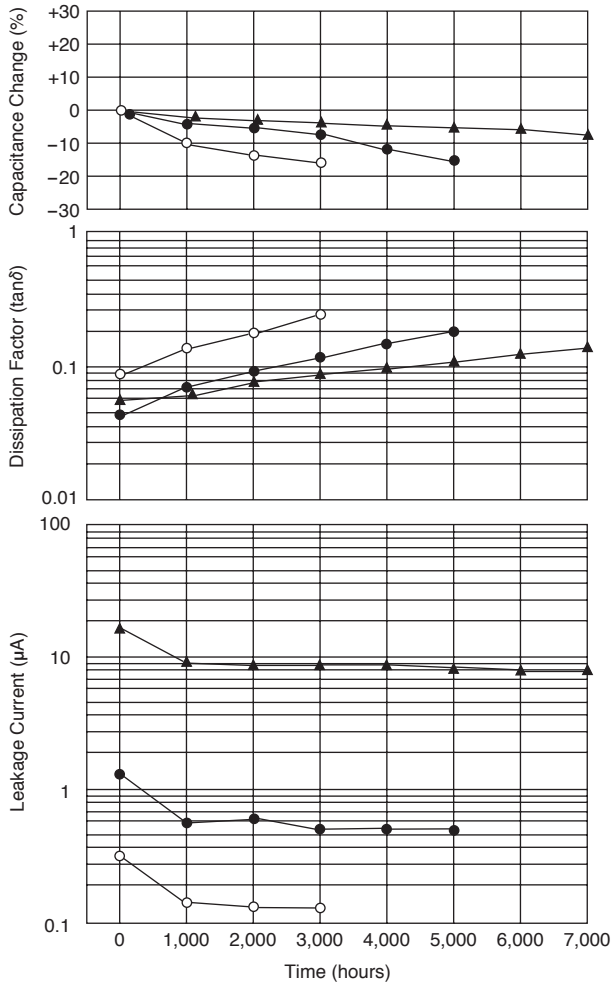

●105°C Shelf Life test

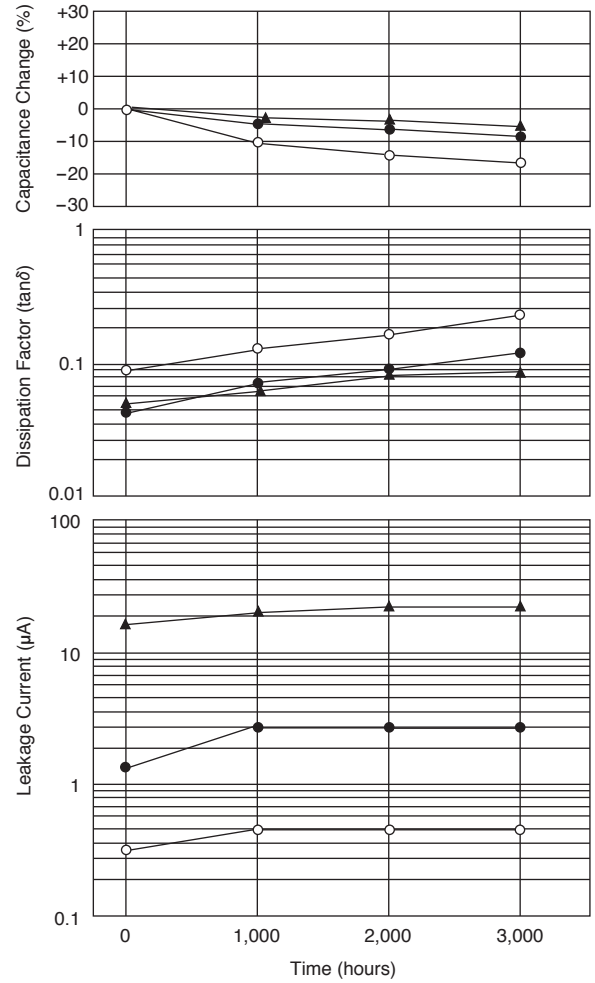

●Temperature Characteristics

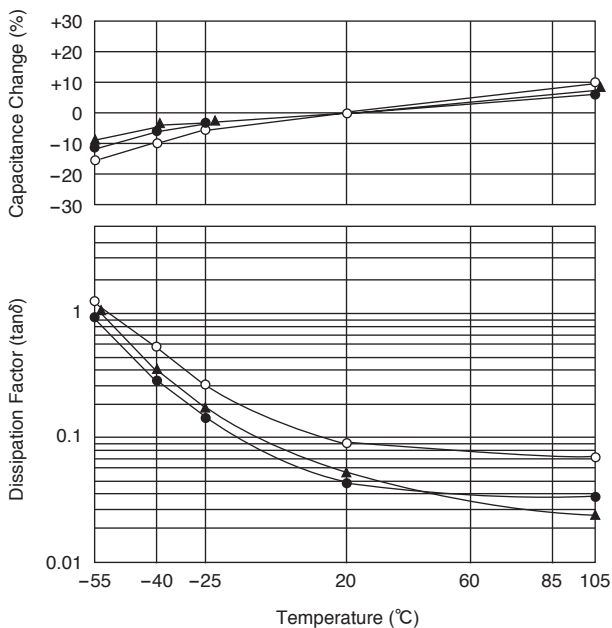

●Impedance-Frequency Characteristics

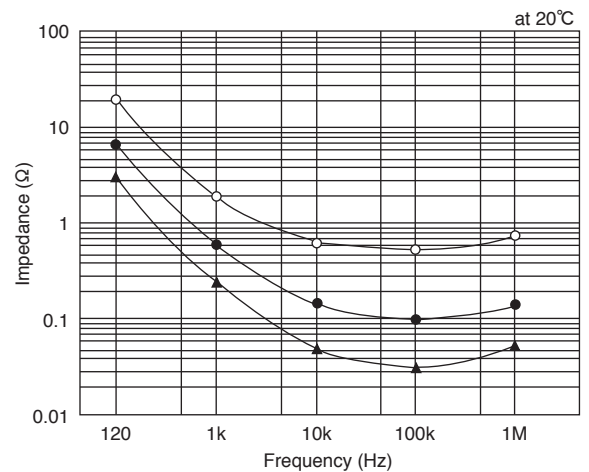

●125°C Endurance with Rated Ripple Current

- GXE 35V 100μF φ8×12L
- △ GXE 50V 100μF φ10×12.5L
- GXE 10V 3300μF φ16×25L

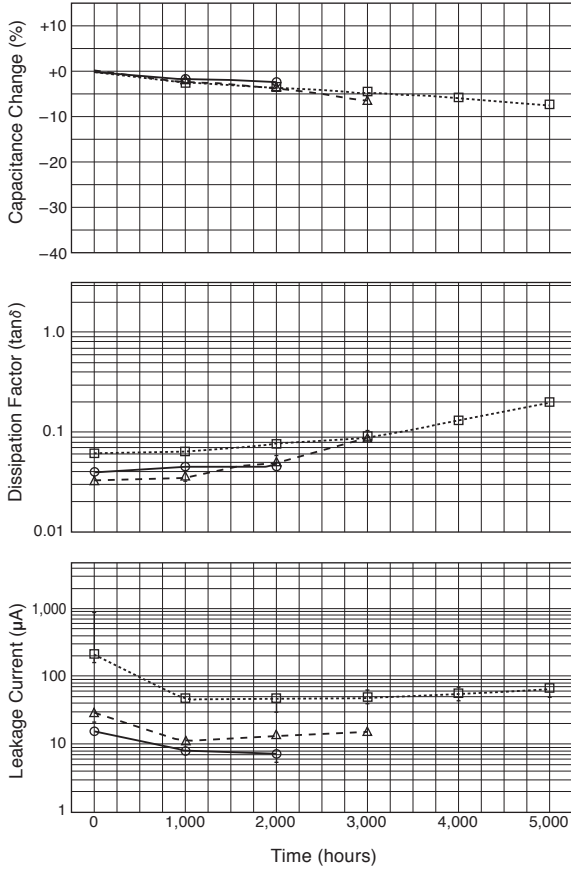

●Impedance-Frequency Characteristics

- GXE 35V 100μF φ8×12L
- △ GXE 50V 100μF φ10×12.5L
- GXE 10V 3300μF φ16×25L at 20°C

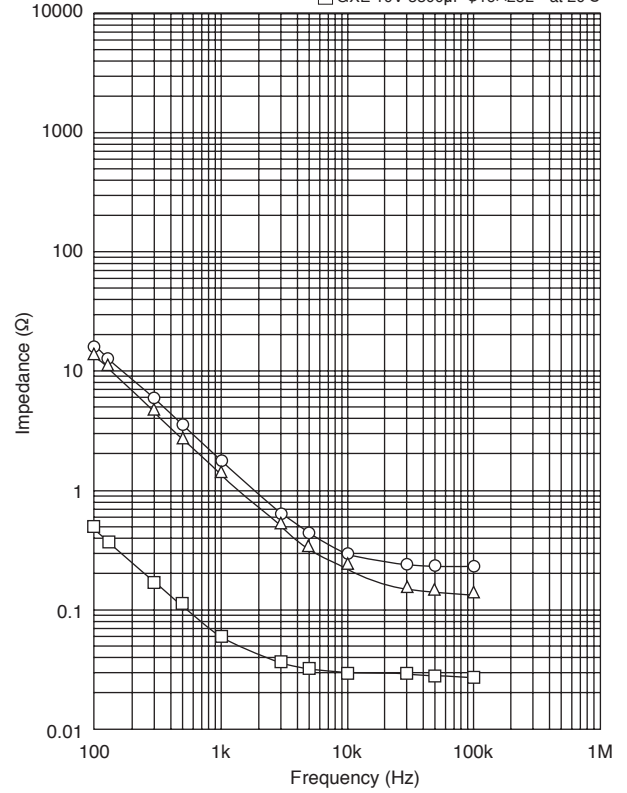

SMM Series

●85°C Endurance with Rated Ripple Current

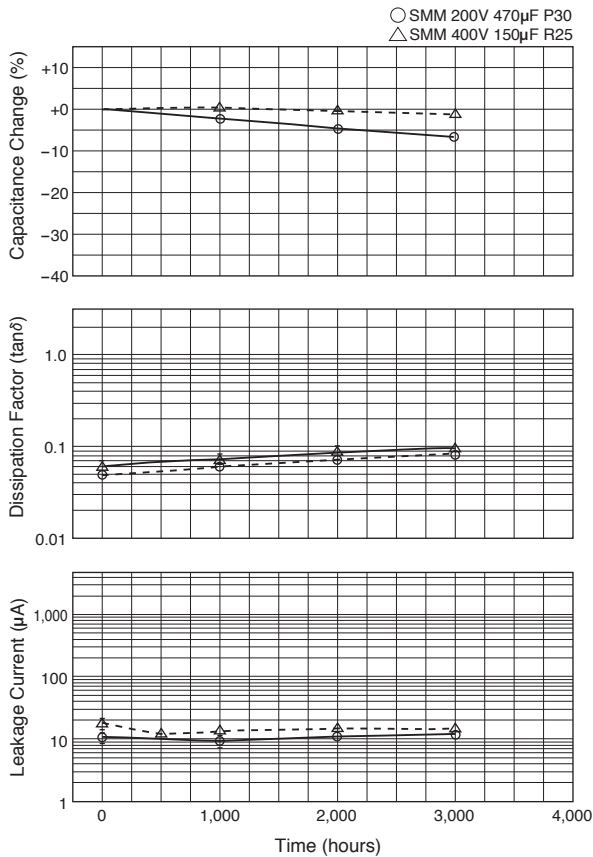

KMM Series

●105°C Endurance with Rated Ripple Current

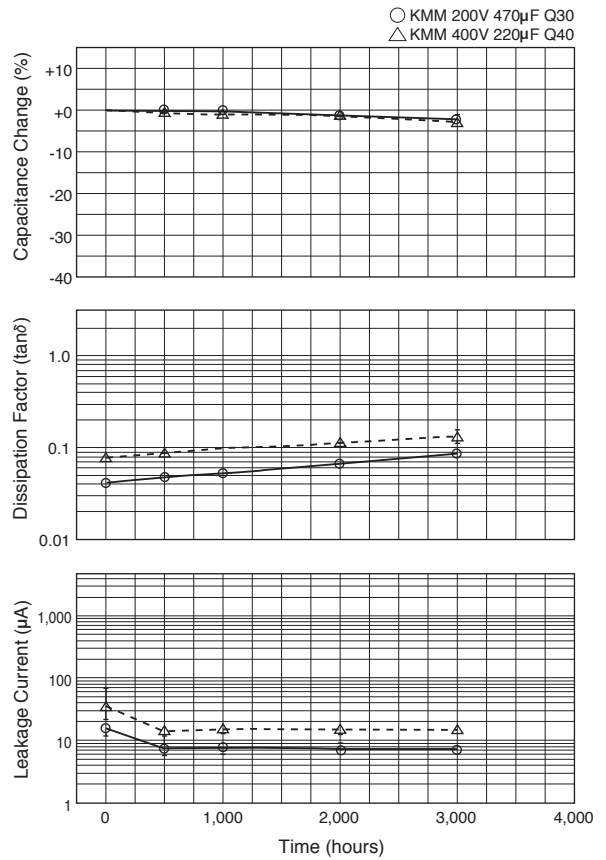

LXG Series

●105°C Endurance with Rated Ripple Current

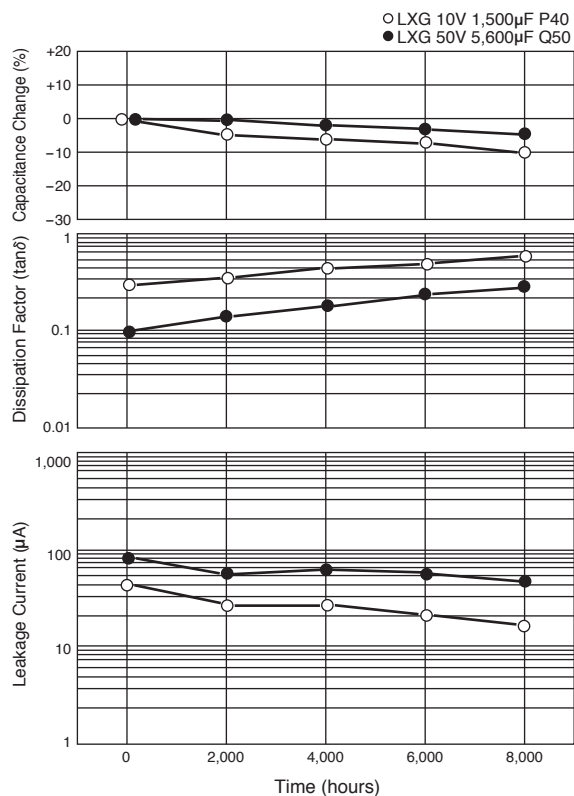

LXH Series

●105°C Endurance with Rated Ripple Current

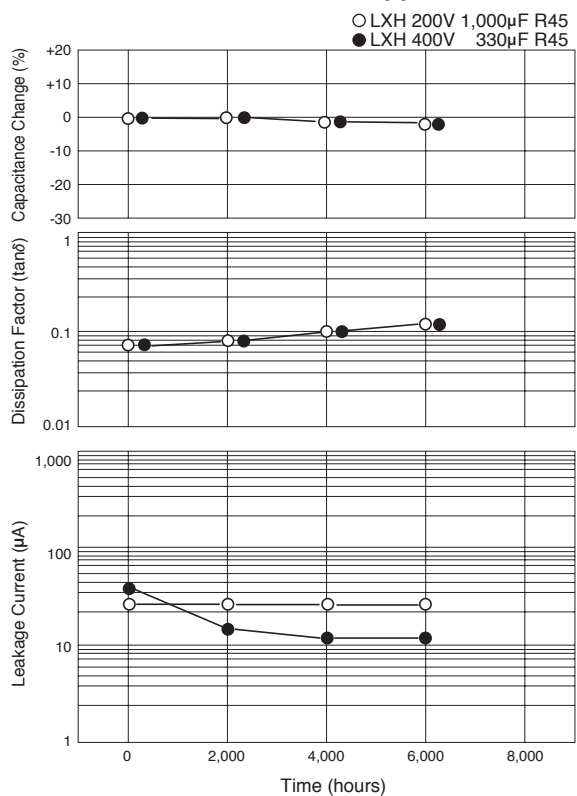

RWE/RWF/RWL Series

RWE/RWF series

●85°C Endurance with Rated Ripple Current

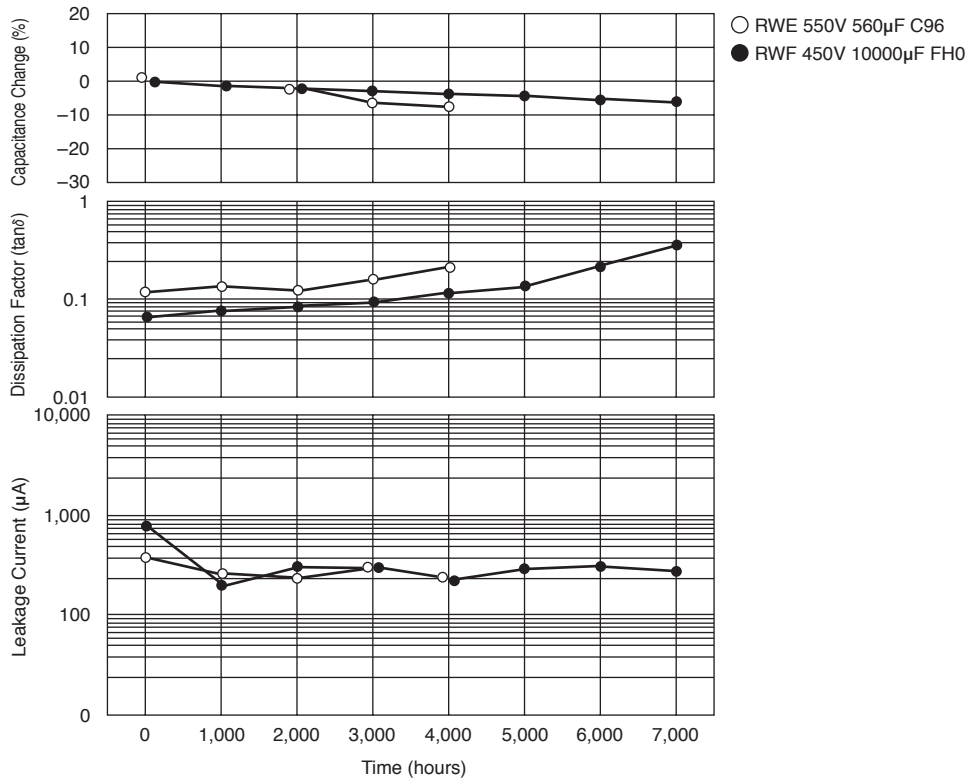

RWL series

●85°C Endurance with Rated Ripple Current

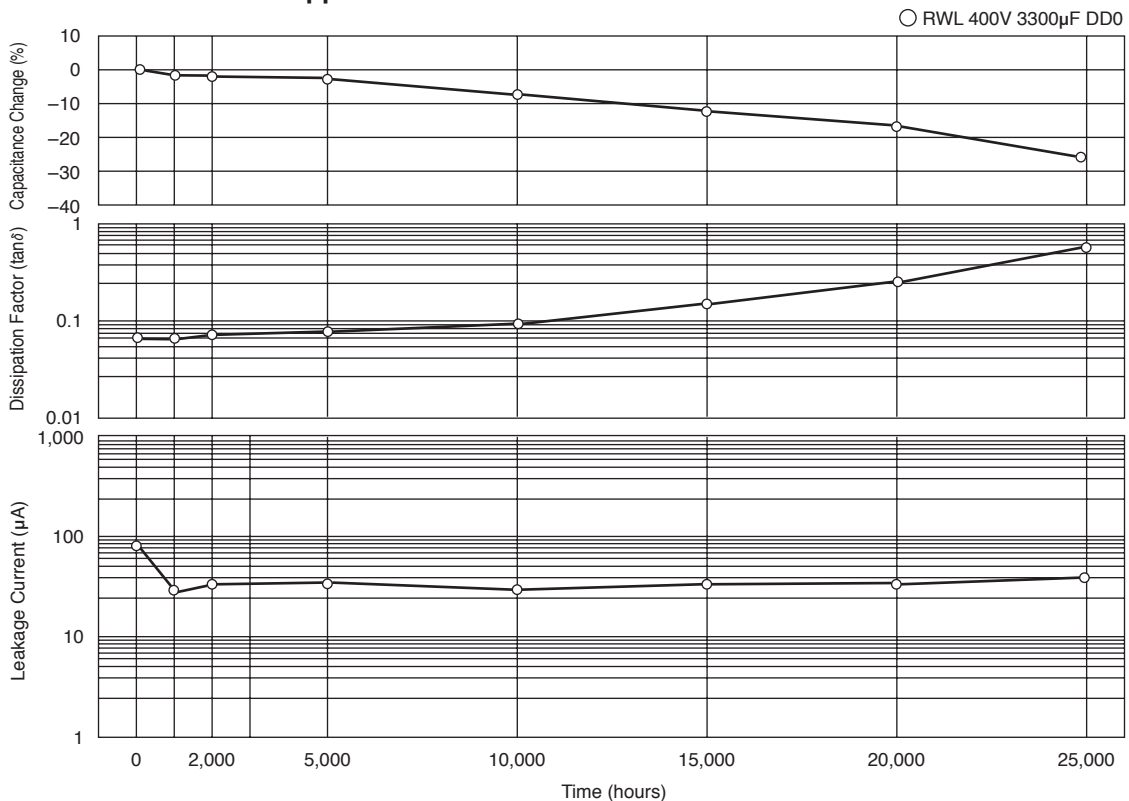

Appendix

Appendix (Part number)

◆Capacitance code

* How to use the table

	1st
2nd	Cap. Value

Capacitance value part

2nd	1st								
	1	2	3	4	5	6	7	8	9
0	10.0	20.0	30.0	40.0	50.0	60.0	70.0	80.0	90.0
A	10.5	20.5	30.5	40.5	50.5	60.5	70.5	80.5	90.5
1	11.0	21.0	31.0	41.0	51.0	61.0	71.0	81.0	91.0
B	11.5	21.5	31.5	41.5	51.5	61.5	71.5	81.5	91.5
2	12.0	22.0	32.0	42.0	52.0	62.0	72.0	82.0	92.0
C	12.5	22.5	32.5	42.5	52.5	62.5	72.5	82.5	92.5
3	13.0	23.0	33.0	43.0	53.0	63.0	73.0	83.0	93.0
D	13.5	23.5	33.5	43.5	53.5	63.5	73.5	83.5	93.5
4	14.0	24.0	34.0	44.0	54.0	64.0	74.0	84.0	94.0
E	14.5	24.5	34.5	44.5	54.5	64.5	74.5	84.5	94.5
5	15.0	25.0	35.0	45.0	55.0	65.0	75.0	85.0	95.0
F	15.5	25.5	35.5	45.5	55.5	65.5	75.5	85.5	95.5
6	16.0	26.0	36.0	46.0	56.0	66.0	76.0	86.0	96.0
G	16.5	26.5	36.5	46.5	56.5	66.5	76.5	86.5	96.5
7	17.0	27.0	37.0	47.0	57.0	67.0	77.0	87.0	97.0
H	17.5	27.5	37.5	47.5	57.5	67.5	77.5	87.5	97.5
8	18.0	28.0	38.0	48.0	58.0	68.0	78.0	88.0	98.0
J	18.5	28.5	38.5	48.5	58.5	68.5	78.5	88.5	98.5
9	19.0	29.0	39.0	49.0	59.0	69.0	79.0	89.0	99.0
K	19.5	29.5	39.5	49.5	59.5	69.5	79.5	89.5	99.5



For less than 10 μ F, a decimal point position is displayed with R.

For 10 μ F or more, capacitance code is set to the first 2 digits and index (1digit).

Treatment of fraction (Refer to the table)

Example of conversion

Real cap.	The first 2 digits	Treatment of fraction	Code		
			11th	12th	13th
10.0 μ F →	10.0 →	10.0 →	1	0	0
10.1 μ F →	10.1 →	10.0 →	1	0	0
10.2 μ F →	10.2 →	10.0 →	1	0	0
10.3 μ F →	10.3 →	10.5 →	1	A	0
10.4 μ F →	10.4 →	10.5 →	1	A	0
10.5 μ F →	10.5 →	10.5 →	1	A	0
10.6 μ F →	10.6 →	10.5 →	1	A	0
10.7 μ F →	10.7 →	10.5 →	1	A	0
10.8 μ F →	10.8 →	11.0 →	1	1	0
10.9 μ F →	10.9 →	11.0 →	1	1	0
11.0 μ F →	11.0 →	11.0 →	1	1	0
132 μ F →	13.2 →	13.0 →	1	3	1
133 μ F →	13.3 →	13.5 →	1	D	1
167 μ F →	16.7 →	16.5 →	1	G	1
168 μ F →	16.8 →	17.0 →	1	7	1
1110 μ F →	11.1 →	11.0 →	1	1	2
1340 μ F →	13.4 →	13.5 →	1	D	2
13200 μ F →	13.2 →	13.0 →	1	3	3
13600 μ F →	13.6 →	13.5 →	1	D	3
270000 μ F →	27.0 →	27.0 →	2	7	4

◆Case length (Radial lead type)

Case length [mm]	16th	17th	Case length [mm]	16th	17th	Case length [mm]	16th	17th	Case length [mm]	16th	17th	Case length [mm]	16th	17th	Case length [mm]	16th	17th
0.0	—	—	1.0	0	1	2.0	0	2	3.0	0	3	4.0	0	4			
0.1	0	B	1.1	1	B	2.1	2	B	3.1	3	B	4.1	4	B			
0.2	0	C	1.2	1	C	2.2	2	C	3.2	3	C	4.2	4	C			
0.3	0	D	1.3	1	D	2.3	2	D	3.3	3	D	4.3	4	D			
0.4	0	E	1.4	1	E	2.4	2	E	3.4	3	E	4.4	4	E			
0.5	0	F	1.5	1	F	2.5	2	F	3.5	3	F	4.5	4	F			
0.6	0	G	1.6	1	G	2.6	2	G	3.6	3	G	4.6	4	G			
0.7	0	H	1.7	1	H	2.7	2	H	3.7	3	H	4.7	4	H			
0.8	0	J	1.8	1	J	2.8	2	J	3.8	3	J	4.8	4	J			
0.9	0	K	1.9	1	K	2.9	2	K	3.9	3	K	4.9	4	K			
5.0	0	5	6.0	0	6	7.0	0	7	8.0	0	8	9.0	0	9			
5.1	5	B	6.1	6	B	7.1	7	B	8.1	8	B	9.1	9	B			
5.2	5	C	6.2	6	C	7.2	7	C	8.2	8	C	9.2	9	C			
5.3	5	D	6.3	6	D	7.3	7	D	8.3	8	D	9.3	9	D			
5.4	5	E	6.4	6	E	7.4	7	E	8.4	8	E	9.4	9	E			
5.5	5	F	6.5	6	F	7.5	7	F	8.5	8	F	9.5	9	F			
5.6	5	G	6.6	6	G	7.6	7	G	8.6	8	G	9.6	9	G			
5.7	5	H	6.7	6	H	7.7	7	H	8.7	8	H	9.7	9	H			
5.8	5	J	6.8	6	J	7.8	7	J	8.8	8	J	9.8	9	J			
5.9	5	K	6.9	6	K	7.9	7	K	8.9	8	K	9.9	9	K			
10.0	1	0	11.0	1	1	12.0	1	2	13.0	1	3	14.0	1	4			
10.1	A	1	11.1	B	1	12.1	C	1	13.1	D	1	14.1	E	1			
10.2	A	2	11.2	B	2	12.2	C	2	13.2	D	2	14.2	E	2			
10.3	A	3	11.3	B	3	12.3	C	3	13.3	D	3	14.3	E	3			
10.4	A	4	11.4	B	4	12.4	C	4	13.4	D	4	14.4	E	4			
10.5	A	5	11.5	B	5	12.5	C	5	13.5	D	5	14.5	E	5			
10.6	A	6	11.6	B	6	12.6	C	6	13.6	D	6	14.6	E	6			
10.7	A	7	11.7	B	7	12.7	C	7	13.7	D	7	14.7	E	7			
10.8	A	8	11.8	B	8	12.8	C	8	13.8	D	8	14.8	E	8			
10.9	A	9	11.9	B	9	12.9	C	9	13.9	D	9	14.9	E	9			



PART NUMBERING SYSTEM

Case length [mm]	16th	17th
15.0	1	5
15.1	F	1
15.2	F	2
15.3	F	3
15.4	F	4
15.5	F	5
15.6	F	6
15.7	F	7
15.8	F	8
15.9	F	9

Case length [mm]	16th	17th
16.0	1	6
16.1	G	1
16.2	G	2
16.3	G	3
16.4	G	4
16.5	G	5
16.6	G	6
16.7	G	7
16.8	G	8
16.9	G	9

Case length [mm]	16th	17th
17.0	1	7
17.1	H	1
17.2	H	2
17.3	H	3
17.4	H	4
17.5	H	5
17.6	H	6
17.7	H	7
17.8	H	8
17.9	H	9

Case length [mm]	16th	17th
18.0	1	8
18.1	J	1
18.2	J	2
18.3	J	3
18.4	J	4
18.5	J	5
18.6	J	6
18.7	J	7
18.8	J	8
18.9	J	9

Case length [mm]	16th	17th
19.0	1	9
19.1	K	1
19.2	K	2
19.3	K	3
19.4	K	4
19.5	K	5
19.6	K	6
19.7	K	7
19.8	K	8
19.9	K	9

Case length [mm]	16th	17th
20.0	2	0
20.5	L	1
21.0	2	1
21.5	L	3
22.0	2	2
22.5	L	5
23.0	2	3
23.5	L	7
24.0	2	4
24.5	L	9
25.0	2	5
25.5	M	1
26.0	2	6
26.5	M	3
27.0	2	7
27.5	M	5
28.0	2	8
28.5	M	7
29.0	2	9
29.5	M	9

Case length [mm]	16th	17th
30.0	3	0
30.5	N	1
31.0	3	1
31.5	N	3
32.0	3	2
32.5	N	5
33.0	3	3
33.5	N	7
34.0	3	4
34.5	N	9
35.0	3	5
35.5	P	1
36.0	3	6
36.5	P	3
37.0	3	7
37.5	P	5
38.0	3	8
38.5	P	7
39.0	3	9
39.5	P	9

Case length [mm]	16th	17th
40.0	4	0
40.5	Q	1
41.0	4	1
41.5	Q	3
42.0	4	2
42.5	Q	5
43.0	4	3
43.5	Q	7
44.0	4	4
44.5	Q	9
45.0	4	5
45.5	R	1
46.0	4	6
46.5	R	3
47.0	4	7
47.5	R	5
48.0	4	8
48.5	R	7
49.0	4	9
49.5	R	9

Case length [mm]	16th	17th
50.0	5	0
50.5	S	1
51.0	5	1
51.5	S	3
52.0	5	2
52.5	S	5
53.0	5	3
53.5	S	7
54.0	5	4
54.5	S	9
55.0	5	5
55.5	T	1
56.0	5	6
56.5	T	3
57.0	5	7
57.5	T	5
58.0	5	8
58.5	T	7
59.0	5	9
59.5	T	9

Case length [mm]	16th	17th
60.0	6	0
60.5	U	1
61.0	6	1
61.5	U	3
62.0	6	2
62.5	U	5
63.0	6	3
63.5	U	7
64.0	6	4
64.5	U	9
65.0	6	5
65.5	V	1
66.0	6	6
66.5	V	3
67.0	6	7
67.5	V	5
68.0	6	8
68.5	V	7
69.0	6	9
69.5	V	9

Case length [mm]	16th	17th
70.0	7	0
70.5	W	1
71.0	7	1
71.5	W	3
72.0	7	2
72.5	W	5
73.0	7	3
73.5	W	7
74.0	7	4
74.5	W	9
75.0	7	5
75.5	X	1
76.0	7	6
76.5	X	3
77.0	7	7
77.5	X	5
78.0	7	8
78.5	X	7
79.0	7	9
79.5	X	9

Case length [mm]	16th	17th
80.0	8	0
80.5	Y	1
81.0	8	1
81.5	Y	3
82.0	8	2
82.5	Y	5
83.0	8	3
83.5	Y	7
84.0	8	4
84.5	Y	9
85.0	8	5
85.5	Z	1
86.0	8	6
86.5	Z	3
87.0	8	7
87.5	Z	5
88.0	8	8
88.5	Z	7
89.0	8	9
89.5	Z	9

◆Case length (Snap-in type / Screw mount terminal type)

Case length [mm]	16th	17th	Case length [mm]	16th	17th	Case length [mm]	16th	17th	Case length [mm]	16th	17th	Case length [mm]	16th	17th
20	2	0	30	3	0	40	4	0	50	5	0	60	6	0
21	2	1	31	3	1	41	4	1	51	5	1	61	6	1
22	2	2	32	3	2	42	4	2	52	5	2	62	6	2
23	2	3	33	3	3	43	4	3	53	5	3	63	6	3
24	2	4	34	3	4	44	4	4	54	5	4	64	6	4
25	2	5	35	3	5	45	4	5	55	5	5	65	6	5
26	2	6	36	3	6	46	4	6	56	5	6	66	6	6
27	2	7	37	3	7	47	4	7	57	5	7	67	6	7
28	2	8	38	3	8	48	4	8	58	5	8	68	6	8
29	2	9	39	3	9	49	4	9	59	5	9	69	6	9
70	7	0	80	8	0	90	9	0	100	A	0	110	B	0
71	7	1	81	8	1	91	9	1	101	A	1	111	B	1
72	7	2	82	8	2	92	9	2	102	A	2	112	B	2
73	7	3	83	8	3	93	9	3	103	A	3	113	B	3
74	7	4	84	8	4	94	9	4	104	A	4	114	B	4
75	7	5	85	8	5	95	9	5	105	A	5	115	B	5
76	7	6	86	8	6	96	9	6	106	A	6	116	B	6
77	7	7	87	8	7	97	9	7	107	A	7	117	B	7
78	7	8	88	8	8	98	9	8	108	A	8	118	B	8
79	7	9	89	8	9	99	9	9	109	A	9	119	B	9
120	C	0	130	D	0	140	E	0	150	F	0	160	G	0
121	C	1	131	D	1	141	E	1	151	F	1	161	G	1
122	C	2	132	D	2	142	E	2	152	F	2	162	G	2
123	C	3	133	D	3	143	E	3	153	F	3	163	G	3
124	C	4	134	D	4	144	E	4	154	F	4	164	G	4
125	C	5	135	D	5	145	E	5	155	F	5	165	G	5
126	C	6	136	D	6	146	E	6	156	F	6	166	G	6
127	C	7	137	D	7	147	E	7	157	F	7	167	G	7
128	C	8	138	D	8	148	E	8	158	F	8	168	G	8
129	C	9	139	D	9	149	E	9	159	F	9	169	G	9
170	H	0	180	J	0	190	K	0	200	L	0	210	M	0
171	H	1	181	J	1	191	K	1	201	L	1	211	M	1
172	H	2	182	J	2	192	K	2	202	L	2	212	M	2
173	H	3	183	J	3	193	K	3	203	L	3	213	M	3
174	H	4	184	J	4	194	K	4	204	L	4	214	M	4
175	H	5	185	J	5	195	K	5	205	L	5	215	M	5
176	H	6	186	J	6	196	K	6	206	L	6	216	M	6
177	H	7	187	J	7	197	K	7	207	L	7	217	M	7
178	H	8	188	J	8	198	K	8	208	L	8	218	M	8
179	H	9	189	J	9	199	K	9	209	L	9	219	M	9
220	N	0	230	P	0	240	Q	0	250	R	0			
221	N	1	231	P	1	241	Q	1	251	R	1			
222	N	2	232	P	2	242	Q	2	252	R	2			
223	N	3	233	P	3	243	Q	3	253	R	3			
224	N	4	234	P	4	244	Q	4	254	R	4			
225	N	5	235	P	5	245	Q	5	255	R	5			
226	N	6	236	P	6	246	Q	6	256	R	6			
227	N	7	237	P	7	247	Q	7	257	R	7			
228	N	8	238	P	8	248	Q	8	258	R	8			
229	N	9	239	P	9	249	Q	9	259	R	9			

◆Supplement code

Conductive polymer Chip and Radial lead type / Electrolytec Chip type

	Terminal plating material	
	Sn	Sn-Bi
Coating case	S	G

Radial lead type / Snap-in type

		Terminal plating material	
		Sn	Sn-Bi
Outer sleeve	PET	S	D
	Coating case	H	G
	Polyolefin	L	—
	Pb-free PVC	M	—

* Pb-free snap-in type does not have a plastic disk.

We also produce Pb-free snap-in type with "Plastic disk, Pb-free PVC sleeve and Sn terminal plating".
In this case, supplement code (the 18th digit) is "T".

Screw mount terminal type

	Screw terminal
Pb-free PVC	M
Polyolefin	S
PET	C