

Aluminum Capacitors Radial Very Low Impedance

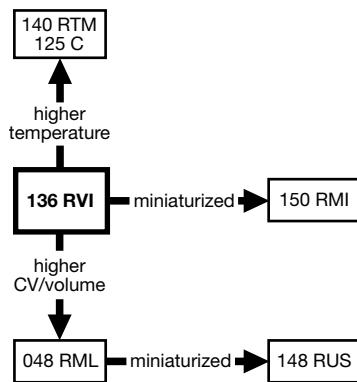


Fig. 1

QUICK REFERENCE DATA	
DESCRIPTION	VALUE
Nominal case sizes (Ø D x L in mm)	10 x 12 to 18 x 35
Rated capacitance range, C _R	22 µF to 10 000 µF
Tolerance on C _R	± 20 %
Rated voltage range, C _R	10 V to 100 V
Category temperature range	- 55 °C to + 105 °C
Endurance test at 105 °C	3000 h to 5000 h (dependent on case size)
Useful life at 105 °C	4000 h to 10 000 h (dependent on case size)
Useful life at 40 °C, 1.8 x I _R applied	200 000 h to 500 000 h (dependent on case size)
Shelf life at 0 V, 105 °C	1000 h
Based on sectional specification	IEC 60384-4/EN130300
Climatic category IEC 60068	55/105/56

FEATURES

- Very low impedance or ESR respectively
- Very long useful life:
4000 h to 10 000 h at 105 °C, very high reliability
- Excellent ripple current capability
- Polarized aluminum electrolytic capacitors, non-solid electrolyte
- Radial leads, cylindrical aluminum case with pressure relief, insulated with a blue sleeve
- Charge and discharge proof
- Material categorization: For definitions of compliance please see www.vishay.com/doc?99912



APPLICATIONS

- Power supplies (SMPS, DC/DC converters) for general industrial, EDP, audio-video, and telecommunications
- Smoothing, filtering, buffering

MARKING

The capacitors are marked (where possible) with the following information:

- Rated capacitance value (in µF)
- Tolerance on rated capacitance, code letter in accordance with IEC 60062 (M for ± 20 %)
- Rated voltage (in V)
- Date code, in accordance with IEC 60062
- Code indicating factory of origin
- Name of manufacturer
- Upper category temperature (105 °C)
- Negative terminal identification
- Series number (136)



SELECTION CHART FOR C _R , U _R , AND RELEVANT NOMINAL CASE SIZES (∅ D x L in mm)							
C _R (μF)	U _R (V)						
	10	16	25	35	50	63	100
22	-	-	-	-	-	-	10 x 12
33	-	-	-	-	-	-	10 x 12
47	-	-	-	-	-	10 x 12	10 x 16
56	-	-	-	-	-	10 x 12	-
68	-	-	-	-	-	10 x 16	10 x 20
82	-	-	-	-	10 x 12	-	-
100	-	-	-	-	10 x 12	10 x 16	12.5 x 20
120	-	-	-	10 x 12	10 x 16	10 x 20	-
	-	-	-	-	-	12.5 x 16	-
150	-	-	-	10 x 12	10 x 20	10 x 25	16 x 20
180	-	-	10 x 12	-	10 x 20	10 x 30	-
	-	-	-	-	12.5 x 16	-	-
220	-	-	10 x 12	10 x 16	10 x 25	12.5 x 20	16 x 25
270	-	10 x 12	-	-	-	12.5 x 25	-
330	-	10 x 12	10 x 16	10 x 20	10 x 30	16 x 20	16 x 31
	-	-	-	12.5 x 16	12.5 x 20	-	-
390	10 x 12	-	-	10 x 25	-	12.5 x 31	-
470	10 x 12	10 x 16	10 x 20	12.5 x 20	12.5 x 25	16 x 25	16 x 35
	-	-	12.5 x 16	-	-	-	18 x 31
560	-	-	10 x 25	10 x 30	12.5 x 31	-	-
	-	-	-	12.5 x 20	-	-	-
680	10 x 16	10 x 20	-	12.5 x 25	16 x 20	16 x 31	18 x 35
	-	12.5 x 16	-	-	-	18 x 25	-
820	-	10 x 25	10 x 30	-	16 x 25	16 x 35	-
	-	-	12.5 x 20	-	-	-	-
1000	10 x 20	12.5 x 20	12.5 x 25	12.5 x 31	16 x 31	18 x 31	-
	12.5 x 16	-	-	16 x 20	18 x 20	-	-
1200	10 x 25	10 x 30	-	16 x 25	16 x 35	-	-
	-	12.5 x 20	-	-	-	-	-
1500	10 x 30	12.5 x 25	12.5 x 31	16 x 25	18 x 31	18 x 35	-
	12.5 x 20	-	16 x 20	-	-	-	-
1800	12.5 x 20	-	16 x 25	16 x 31	-	-	-
2200	12.5 x 25	12.5 x 31	16 x 31	16 x 35	18 x 35	-	-
	-	16 x 20	18 x 20	18 x 31	-	-	-
2700	12.5 x 31	16 x 25	16 x 31	-	-	-	-
3300	16 x 20	16 x 25	16 x 35	18 x 35	-	-	-
	-	-	18 x 31	-	-	-	-
3900	16 x 25	16 x 31	-	-	-	-	-
4700	16 x 31	16 x 35	18 x 35	-	-	-	-
	-	18 x 31	-	-	-	-	-
5600	16 x 31	-	-	-	-	-	-
	18 x 25	-	-	-	-	-	-
6800	16 x 35	18 x 35	-	-	-	-	-
	18 x 31	-	-	-	-	-	-
10 000	18 x 35	-	-	-	-	-	-

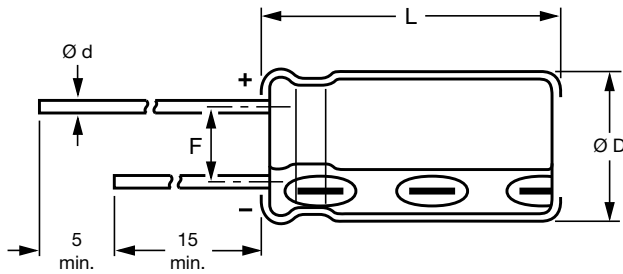
DIMENSIONS in millimeters AND AVAILABLE FORMS


Fig. 2 - Form CA: Long leads

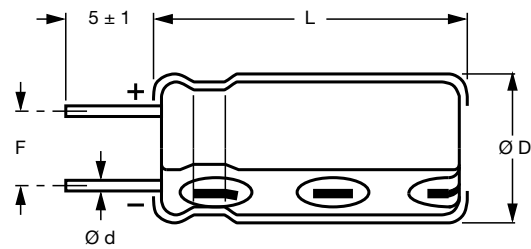


Fig. 3 - Form CB: Cut leads

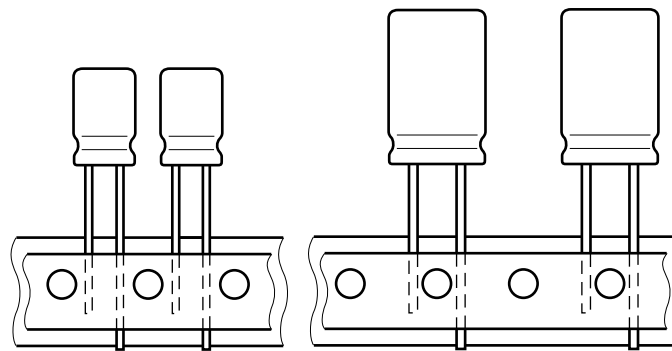


Fig. 4 - Form TFA: Taped in box (ammopack)

Table 1

DIMENSIONS in millimeters, MASS AND PACKAGING QUANTITIES									
NOMINAL CASE SIZE $\varnothing D \times L$	CASE CODE	$\varnothing d$	$\varnothing D_{max.}$	$L_{max.}$	F	MASS (g)	PACKAGING QUANTITIES		
							FORM CA	FORM CB	FORM TFA
10 x 12	14	0.6	10.5	13.5	5.0 ± 0.5	≈ 1.6	1000	500	800
10 x 16	15	0.6	10.5	17.5	5.0 ± 0.5	≈ 1.9	500	500	800
10 x 20	16	0.6	10.5	22.0	5.0 ± 0.5	≈ 2.2	500	500	800
10 x 25	16L	0.6	10.5	27.0	5.0 ± 0.5	≈ 3.0	1000	1500	800
10 x 30	16LL	0.6	10.5	32.0	5.0 ± 0.5	≈ 3.5	1000	750	-
12.5 x 16	17a	0.6	13.0	17.5	5.0 ± 0.5	≈ 2.7	1000	1500	500
12.5 x 20	17	0.6	13.0	22.0	5.0 ± 0.5	≈ 4.0	500	500	500
12.5 x 25	18	0.6	13.0	27.0	5.0 ± 0.5	≈ 5.0	250	250	500
12.5 x 31	18L	0.6	13.0	33.5	5.0 ± 0.5	≈ 5.5	1000	750	-
16 x 20	19a	0.8	16.5	22.0	7.5 ± 0.5	≈ 6.0	250	250	250
16 x 25	19	0.8	16.5	27.0	7.5 ± 0.5	≈ 8.0	250	250	250
16 x 31	20	0.8	16.5	33.5	7.5 ± 0.5	≈ 9.0	100	100	250
16 x 35	21	0.8	16.5	37.5	7.5 ± 0.5	≈ 11.0	100	100	-
18 x 20	1820	0.8	18.5	22.0	7.5 ± 0.5	≈ 8.0	100	100	-
18 x 25	1825	0.8	18.5	27.0	7.5 ± 0.5	≈ 10.0	100	100	-
18 x 31	1831	0.8	18.5	33.5	7.5 ± 0.5	≈ 12.5	100	100	-
18 x 35	22	0.8	18.5	37.5	7.5 ± 0.5	≈ 14.5	100	100	-

Note

- For detailed tape dimensions refer to packaging information: www.vishay.com/doc?28360



ELECTRICAL DATA	
SYMBOL	DESCRIPTION
C _R	Rated capacitance at 100 Hz, tolerance ± 20 %
I _R	Rated RMS ripple current at 100 kHz, 105 °C
I _{L2}	Max. leakage current after 2 min at U _R
tan δ	Max. dissipation factor at 100 Hz
Z	Max. impedance at 100 kHz

ORDERING EXAMPLE

Electrolytic capacitor 136 series
 1000 µF/25 V; ± 20 %
 Nominal case size: Ø 12.5 mm x 25 mm; form TFA
 Ordering code: MAL2 136 36102 E3
 Former 12NC: 2222 136 36102

Note

- Unless otherwise specified, all electrical values in Table 2 apply at T_{amb} = 20 °C, P = 86 kPa to 106 kPa, RH = 45 % to 75 %

Table 2

ELECTRICAL DATA AND ORDERING INFORMATION										
U _R (V)	C _R 100 Hz (µF)	NOMINAL CASE SIZE Ø D x L (mm)	I _R 100 kHz 105 °C (mA)	I _{L2} 2 min (µA)	tan δ 100 Hz	Z 100 kHz + 20 °C (mΩ)	Z 100 kHz - 10 °C (mΩ)	ORDERING CODE MAL2136.....		
								BULK PACKAGING		TAPED
								FORM CA	FORM CB	FORM TFA
10	390	10 x 12	630	39	0.19	120	240	54391E3	64391E3	34391E3
	470	10 x 12	630	47	0.19	120	240	54471E3	64471E3	34471E3
	680	10 x 16	830	68	0.19	84	170	54681E3	64681E3	34681E3
	1000	10 x 20	1000	100	0.19	62	130	54102E3	64102E3	34102E3
	1000	12.5 x 16	940	100	0.19	76	160	94105E3	94106E3	94103E3
	1200	10 x 25	1300	120	0.19	52	110	54122E3	64122E3	34122E3
	1500	10 x 30	1400	150	0.19	44	88	94155E3	94156E3	-
	1500	12.5 x 20	1300	150	0.19	46	92	54152E3	64152E3	34152E3
	1800	12.5 x 20	1340	180	0.19	46	92	54182E3	64182E3	34182E3
	2200	12.5 x 25	1700	220	0.21	34	68	54222E3	64222E3	34222E3
	2700	12.5 x 31	2000	270	0.21	30	60	54272E3	64272E3	-
	3300	16 x 20	1600	330	0.23	38	76	54332E3	64332E3	34332E3
	3900	16 x 25	2100	390	0.23	28	56	54392E3	64392E3	34392E3
	4700	16 x 31	2400	470	0.25	25	50	54472E3	64472E3	34472E3
	5600	16 x 31	2400	560	0.27	25	50	54562E3	64562E3	34562E3
	5600	18 x 25	2270	560	0.27	25	50	94565E3	94566E3	-
6800	16 x 35	2600	680	0.29	22	44	54682E3	64682E3	-	
6800	18 x 31	2760	680	0.29	23	46	94685E3	94686E3	-	
10 000	18 x 35	3180	1000	0.31	21	42	54103E3	64103E3	-	
16	270	10 x 12	630	43	0.16	120	240	55271E3	65271E3	35271E3
	330	10 x 12	630	53	0.16	120	240	55331E3	65331E3	35331E3
	470	10 x 16	830	75	0.16	84	170	55471E3	65471E3	35471E3
	680	10 x 20	1000	110	0.16	62	130	55681E3	65681E3	35681E3
	680	12.5 x 16	940	110	0.16	76	160	95685E3	95686E3	95683E3
	820	10 x 25	1300	130	0.16	52	110	55821E3	65821E3	35821E3
	1000	12.5 x 20	1300	160	0.16	48	96	55102E3	65102E3	35102E3
	1200	10 x 30	1400	190	0.16	44	88	95125E3	95126E3	-
	1200	12.5 x 20	1300	190	0.16	46	92	55122E3	65122E3	35122E3
	1500	12.5 x 25	1700	240	0.16	34	68	55152E3	65152E3	35152E3
	2200	12.5 x 31	2000	350	0.18	30	60	95225E3	95226E3	-
	2200	16 x 20	1600	350	0.18	38	76	55222E3	65222E3	35222E3
	2700	16 x 25	2100	430	0.18	28	56	55272E3	65272E3	35272E3
	3300	16 x 25	2100	530	0.20	28	56	55332E3	65332E3	35332E3
	3900	16 x 31	2400	620	0.20	25	50	55392E3	65392E3	35392E3
	4700	16 x 35	2600	750	0.22	22	44	55472E3	65472E3	-
4700	18 x 31	2560	750	0.22	23	46	95475E3	95476E3	-	
6800	18 x 35	3000	1090	0.24	21	42	55682E3	65682E3	-	



ELECTRICAL DATA AND ORDERING INFORMATION

U _R (V)	C _R 100 Hz (μF)	NOMINAL CASE SIZE Ø D x L (mm)	I _R 100 kHz 105 °C (mA)	I _{L2} 2 min (μA)	tan δ 100 Hz	Z 100 kHz + 20 °C (mΩ)	Z 100 kHz - 10 °C (mΩ)	ORDERING CODE MAL2136.....		
								BULK PACKAGING		TAPED
								FORM CA	FORM CB	FORM TFA
25	180	10 x 12	630	45	0.14	120	240	56181E3	66181E3	36181E3
	220	10 x 12	630	55	0.14	120	240	56221E3	66221E3	36221E3
	330	10 x 16	830	83	0.14	84	170	56331E3	66331E3	36331E3
	470	10 x 20	1000	120	0.14	62	130	56471E3	66471E3	36471E3
	470	12.5 x 16	940	120	0.14	76	160	96475E3	96476E3	96473E3
	560	10 x 25	1300	140	0.14	52	110	56561E3	66561E3	36561E3
	820	10 x 30	1400	210	0.14	44	88	96825E3	96826E3	-
	820	12.5 x 20	1300	210	0.14	46	92	56821E3	66821E3	36821E3
	1000	12.5 x 25	1700	250	0.14	34	68	56102E3	66102E3	36102E3
	1500	12.5 x 31	2000	380	0.14	30	60	96155E3	96156E3	-
	1500	16 x 20	1700	380	0.14	38	76	56152E3	66152E3	36152E3
	1800	16 x 25	2100	450	0.14	28	56	56182E3	66182E3	36182E3
	2200	16 x 31	2400	550	0.16	25	50	56222E3	66222E3	36222E3
	2200	18 x 20	1680	550	0.16	28	56	96225E3	96226E3	-
	2700	16 x 31	2400	680	0.16	25	50	56272E3	66272E3	36272E3
	3300	16 x 35	2600	830	0.18	22	44	56332E3	66332E3	-
3300	18 x 31	2490	830	0.18	27	54	96335E3	96336E3	-	
4700	18 x 35	3000	1180	0.20	21	42	56472E3	66472E3	-	
35	120	10 x 12	630	42	0.12	120	240	50121E3	60121E3	30121E3
	150	10 x 12	630	53	0.12	120	240	50151E3	60151E3	30151E3
	220	10 x 16	830	77	0.12	84	170	50221E3	60221E3	30221E3
	330	10 x 20	1000	120	0.12	62	130	50331E3	60331E3	30331E3
	330	12.5 x 16	940	120	0.12	76	160	90335E3	90336E3	90333E3
	390	10 x 25	1300	140	0.12	52	110	50391E3	60391E3	30391E3
	470	12.5 x 20	1300	170	0.12	48	96	50471E3	60471E3	30471E3
	560	10 x 30	1400	200	0.12	44	88	90565E3	90566E3	-
	560	12.5 x 20	1300	200	0.12	46	92	50561E3	60561E3	30561E3
	680	12.5 x 25	1700	240	0.12	34	68	50681E3	60681E3	30681E3
	1000	12.5 x 31	2000	350	0.12	30	60	90105E3	90106E3	-
	1000	16 x 20	1700	350	0.12	38	76	50102E3	60102E3	30102E3
	1200	16 x 25	2100	420	0.12	28	56	50122E3	60122E3	30122E3
	1500	16 x 25	2100	530	0.12	28	56	50152E3	60152E3	30152E3
	1800	16 x 31	2400	630	0.12	25	50	50182E3	60182E3	30182E3
	2200	16 x 35	2600	770	0.14	22	44	50222E3	60222E3	-
2200	18 x 31	2320	770	0.14	27	54	90225E3	90226E3	-	
3300	18 x 35	2890	1160	0.16	21	42	50332E3	60332E3	-	
50	82	10 x 12	480	41	0.10	200	400	51829E3	61829E3	31829E3
	100	10 x 12	480	50	0.10	200	400	51101E3	61101E3	31101E3
	120	10 x 16	760	60	0.10	100	200	51121E3	61121E3	31121E3
	150	10 x 20	850	75	0.10	90	180	51151E3	61151E3	31151E3
	180	10 x 20	950	90	0.10	75	150	51181E3	61181E3	31181E3
	180	12.5 x 16	780	90	0.10	59	120	91185E3	91186E3	91183E3
	220	10 x 25	1200	110	0.10	63	130	51221E3	61221E3	31221E3
	330	10 x 30	1300	170	0.10	54	110	91335E3	91336E3	-
	330	12.5 x 20	1200	170	0.10	59	120	51331E3	61331E3	31331E3
	470	12.5 x 25	1500	240	0.10	44	88	51471E3	61471E3	31471E3
	560	12.5 x 31	1700	280	0.10	39	78	51561E3	61561E3	-
	680	16 x 20	1400	340	0.10	50	100	51681E3	61681E3	31681E3
	820	16 x 25	1900	410	0.10	34	68	51821E3	61821E3	31821E3
	1000	16 x 31	2200	500	0.10	30	60	51102E3	61102E3	31102E3
	1000	18 x 20	1510	500	0.10	41	82	91105E3	91106E3	-
	1200	16 x 35	2300	600	0.10	27	54	51122E3	61122E3	-
1500	18 x 31	2200	750	0.10	31	62	51152E3	61152E3	-	
2200	18 x 35	2650	1100	0.12	27	54	51222E3	61222E3	-	

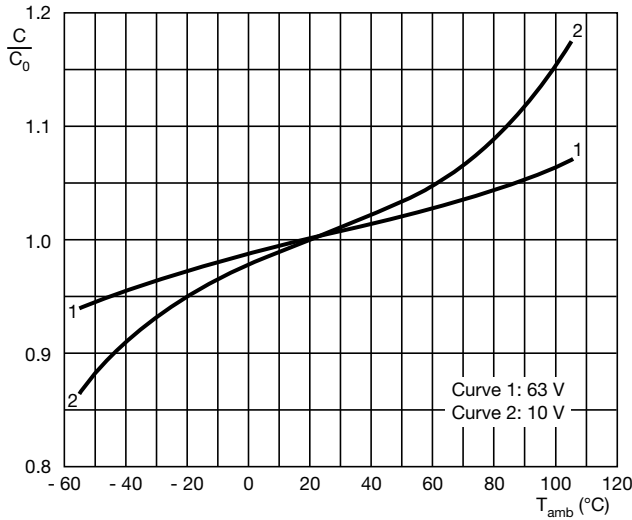


ELECTRICAL DATA AND ORDERING INFORMATION										
U _R (V)	C _R 100 Hz (μF)	NOMINAL CASE SIZE Ø D x L (mm)	I _R 100 kHz 105 °C (mA)	I _{L2} 2 min (μA)	tan δ 100 Hz	Z 100 kHz + 20 °C (mΩ)	Z 100 kHz - 10 °C (mΩ)	ORDERING CODE MAL2136.....		
								BULK PACKAGING		TAPED
								FORM CA	FORM CB	FORM TFA
63	47	10 x 12	380	30	0.10	300	750	58479E3	68479E3	38479E3
	56	10 x 12	420	35	0.10	270	680	58569E3	68569E3	38569E3
	68	10 x 16	520	43	0.10	210	530	58689E3	68689E3	38689E3
	100	10 x 16	580	63	0.10	190	480	58101E3	68101E3	38101E3
	120	10 x 20	650	76	0.10	160	400	58121E3	68121E3	38121E3
	120	12.5 x 16	610	76	0.10	180	450	98125E3	98126E3	98123E3
	150	10 x 25	780	95	0.10	130	330	58151E3	68151E3	38151E3
	180	10 x 30	960	110	0.10	100	250	58181E3	68181E3	-
	220	12.5 x 20	870	140	0.10	110	280	58221E3	68221E3	38221E3
	270	12.5 x 25	1200	170	0.10	74	190	58271E3	68271E3	38271E3
	330	16 x 20	1100	210	0.10	85	220	58331E3	68331E3	38331E3
	390	12.5 x 31	1300	250	0.10	68	170	58391E3	68391E3	-
	470	16 x 25	1500	300	0.10	55	140	58471E3	68471E3	38471E3
	680	16 x 31	1700	430	0.10	46	120	58681E3	68681E3	38681E3
	680	18 x 25	1470	430	0.10	54	108	98685E3	98686E3	-
	820	16 x 35	1900	520	0.10	40	100	58821E3	68821E3	-
1000	18 x 31	1950	630	0.10	39	78	58102E3	68102E3	-	
1500	18 x 35	2350	950	0.10	33	66	58152E3	68152E3	-	
100	22	10 x 12	300	22	0.07	450	2300	59229E3	69229E3	39229E3
	33	10 x 12	320	33	0.07	390	2000	59339E3	69339E3	39339E3
	47	10 x 16	450	47	0.07	320	1600	59479E3	69479E3	39479E3
	68	10 x 20	520	68	0.07	240	1200	59689E3	69689E3	39689E3
	100	12.5 x 20	800	100	0.07	150	750	59101E3	69101E3	39101E3
	150	16 x 20	1000	150	0.07	110	550	59151E3	69151E3	39151E3
	220	16 x 25	1300	220	0.07	81	400	59221E3	69221E3	39221E3
	330	16 x 31	1600	330	0.07	58	290	59331E3	69331E3	39331E3
	470	16 x 35	1800	470	0.07	45	230	59471E3	69471E3	-
	470	18 x 31	1800	470	0.07	45	230	99475E3	99476E3	-
680	18 x 35	2000	680	0.07	39	200	59681E3	69681E3	-	

ADDITIONAL ELECTRICAL DATA		
PARAMETER	CONDITIONS	VALUE
Voltage		
Surge voltage		$U_S \leq 1.15 \times U_R$
Reverse voltage		$U_{rev} \leq 1 V$
Current		
Leakage current	After 2 min at U _R	$I_{L2} \leq 0.01 C_R \times U_R$
Inductance		
Equivalent series inductance (ESL)	Case Ø D = 10 mm	Typ. 16 nH
	Case Ø D ≥ 12.5 mm	Typ. 18 nH
Resistance		
Equivalent series resistance (ESR)	Calculated from tan δ _{max} and C _R (see Table 2)	$ESR = \tan \delta / 2 \pi f C_R$

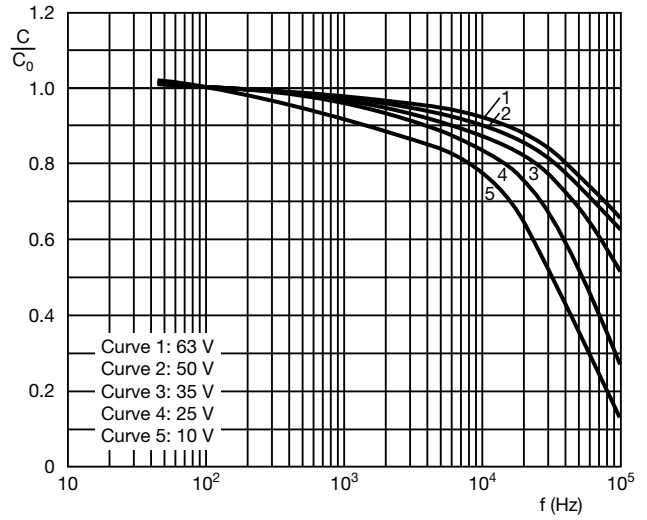


CAPACITANCE (C)



C_0 = Typical capacitance at 20 °C, 100 Hz

Fig. 5 - Typical multiplier of capacitance as a function of ambient temperature

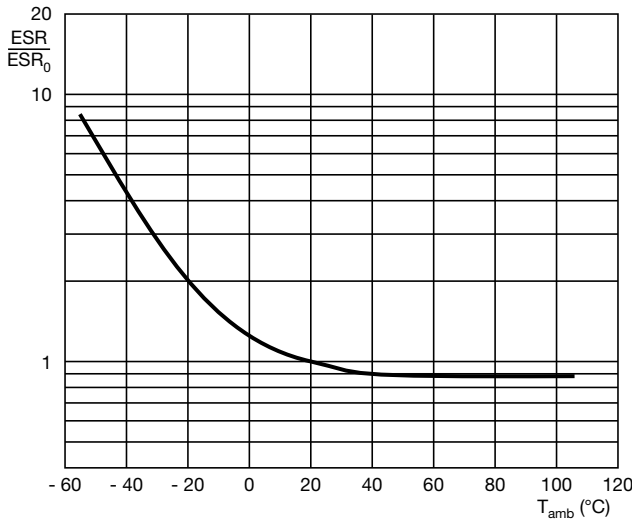


C_0 = Typical capacitance at 20 °C, 100 Hz

$T_{amb} = 20$ °C

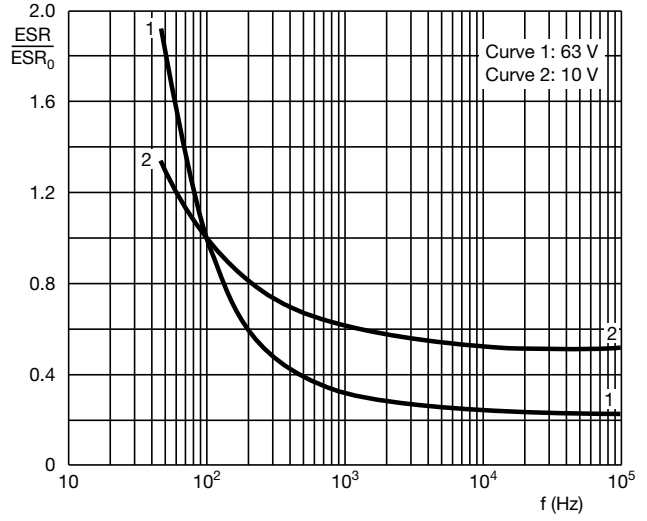
Fig. 6 - Typical multiplier of capacitance as a function of frequency

EQUIVALENT SERIES RESISTANCE (ESR)



ESR_0 = Typical ESR at 20 °C, 100 Hz

Fig. 7 - Typical multiplier of ESR as a function of ambient temperature

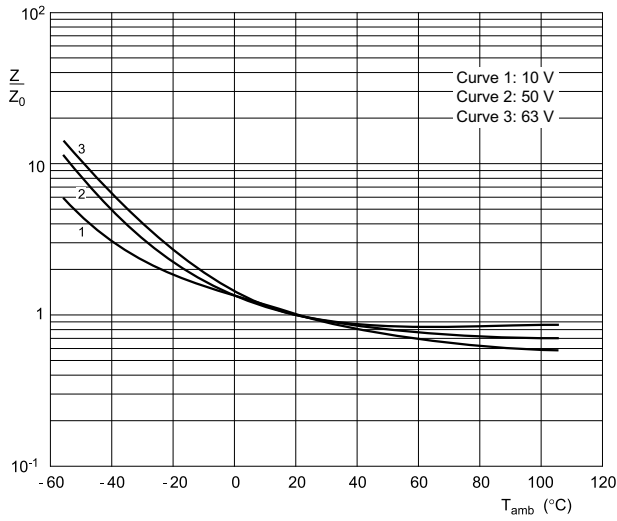


ESR_0 = Typical ESR at 20 °C, 100 Hz

$T_{amb} = 20$ °C

Fig. 8 - Typical multiplier of ESR as a function of frequency

IMPEDANCE (Z)



Z_0 = Typical impedance at 20 °C, 100 kHz

Fig. 9 - Typical multiplier of impedance as a function of ambient temperature

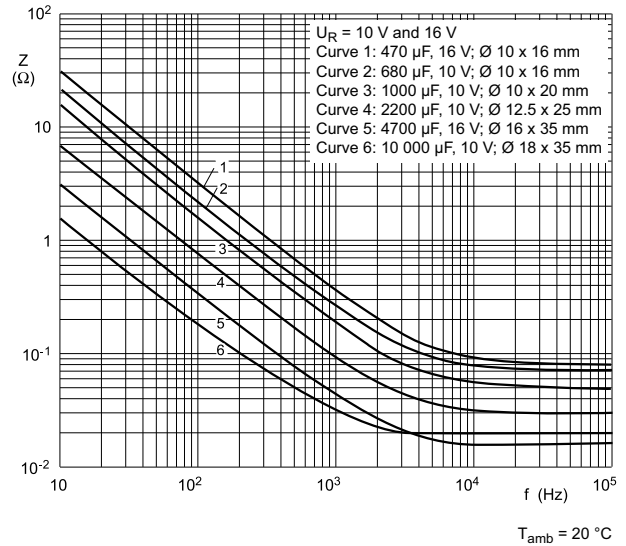


Fig. 10 - Typical impedance as a function of frequency

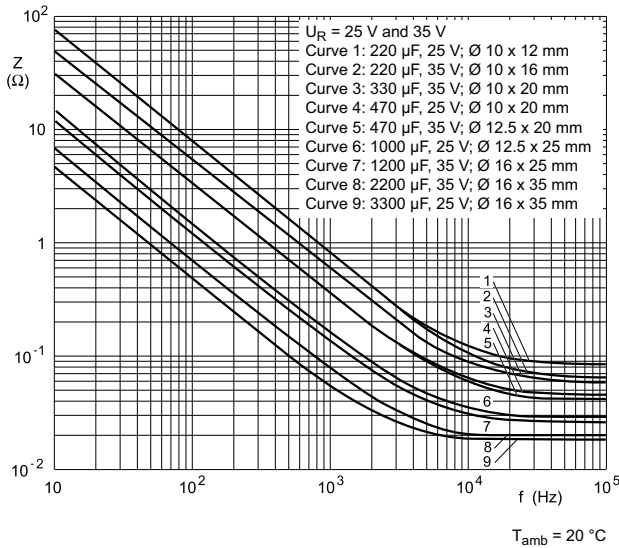


Fig. 11 - Typical impedance as a function of frequency

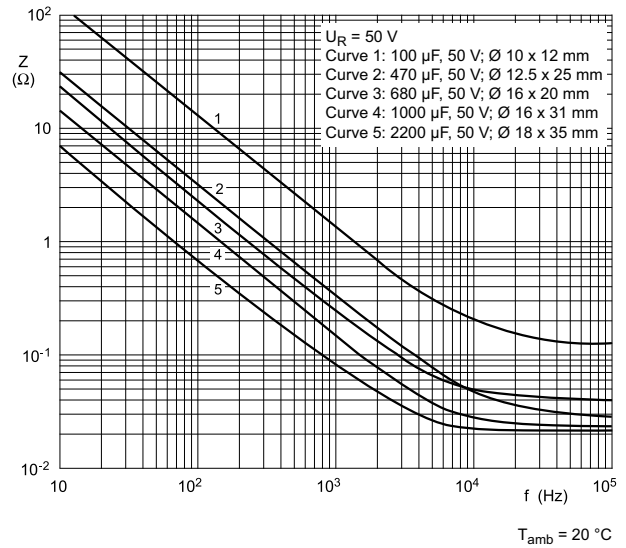


Fig. 12 - Typical impedance as a function of frequency

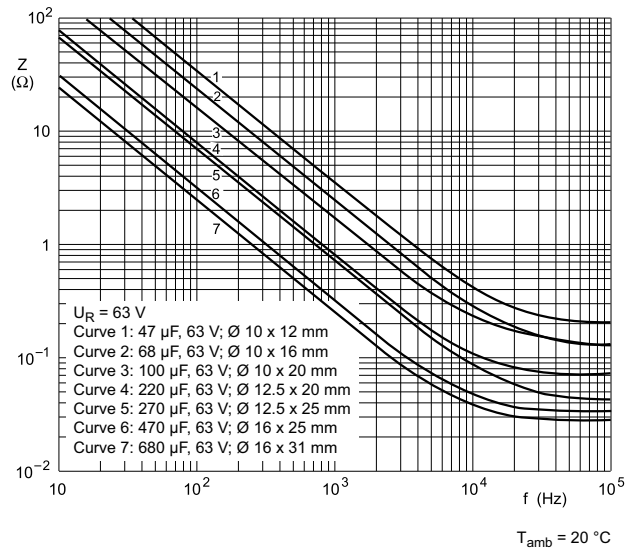


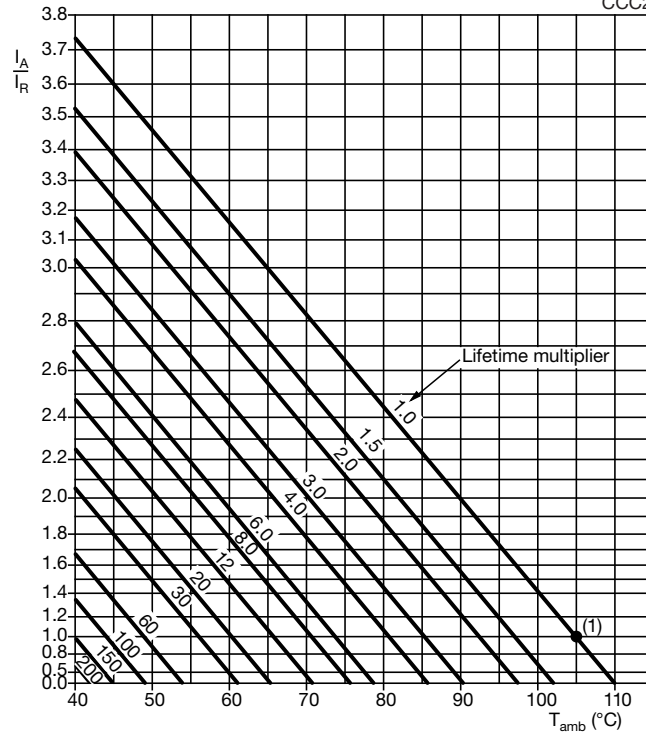
Fig. 13 - Typical impedance as a function of frequency

RIPPLE CURRENT AND USEFUL LIFE

Table 3

ENDURANCE TEST AND USEFUL LIFE AS A FUNCTION OF CASE SIZE			
NOMINAL CASE SIZE Ø D x L (mm)	CASE CODE	ENDURANCE TEST AT 105 °C (h)	USEFUL LIFE AT 105 °C (h)
10 x 12	14	3000	4000
10 x 16	15	3000	6000
10 x 20	16	3000	6000
10 x 25	16L	5000	7000
10 x 30	16LL	5000	7000
12.5 x 16	17a	3000	5000
12.5 x 20	17	3000	7000
12.5 x 25	18	5000	8000
12.5 x 31	18L	5000	8000
16 x 20	19a	3000	7000
16 x 25	19	5000	10 000
16 x 31	20	5000	10 000
16 x 35	21	5000	10 000
18 x 20	1820	3000	7000
18 x 25	1825	5000	10 000
18 x 31	1831	5000	10 000
18 x 35	22	5000	10 000

CCC206



I_A = Actual ripple current at 100 Hz
 I_R = Rated ripple current at 100 Hz, 105 °C
 (1) Useful life at 105 °C and I_R applied; see Table 3

Fig. 14 - Multiplier of useful life as a function of ambient temperature and ripple current load

Table 4

MULTIPLIER OF RIPPLE CURRENT (I_R) AS A FUNCTION OF FREQUENCY								
FREQUENCY (Hz)	I_R MULTIPLIER							
	$U_R = 10\text{ V}$		$U_R = 16\text{ V AND } 25\text{ V}$		$U_R = 35\text{ V AND } 50\text{ V}$		$U_R = 63\text{ V AND } 100\text{ V}$	
	$\varnothing \leq 12.5$	$\varnothing \geq 16$	$\varnothing \leq 12.5$	$\varnothing \geq 16$	$\varnothing \leq 12.5$	$\varnothing \geq 16$	$\varnothing \leq 12.5$	$\varnothing \geq 16$
100	0.70	0.83	0.63	0.69	0.50	0.60	0.35	0.50
300	0.80	0.90	0.72	0.79	0.61	0.71	0.51	0.64
1000	0.88	0.95	0.80	0.87	0.72	0.80	0.66	0.74
3000	0.92	0.98	0.88	0.92	0.81	0.88	0.76	0.83
10 000	0.96	0.99	0.92	0.96	0.88	0.93	0.85	0.90
30 000	0.99	1.00	0.98	0.99	0.94	0.96	0.92	0.95
100 000	1.00	1.00	1.00	1.00	1.00	1.00	1.00	1.00

Table 5

TEST PROCEDURES AND REQUIREMENTS			
TEST		PROCEDURE	REQUIREMENTS
NAME OF TEST	REFERENCE	(quick reference)	
Endurance	IEC 60384-4/EN130300 subclause 4.13	$T_{amb} = 105\text{ °C}$; U_R applied; for test duration see Table 3	$\Delta C/C: \pm 20\%$ $\tan \delta \leq 2 \times \text{spec. limit}$ $I_{L2} \leq \text{spec. limit}$
Useful life	CECC 30301 subclause 1.8.1	$T_{amb} = 105\text{ °C}$; U_R and I_R applied; for test duration see Table 3	$\Delta C/C: \pm 30\%$ $\tan \delta \leq 3 \times \text{spec. limit}$ $I_{L2} \leq \text{spec. limit}$ no short or open circuit total failure percentage: $\leq 1\%$
Shelf life (storage at high temperature)	IEC 60384-4/EN130300 subclause 4.17	$T_{amb} = 105\text{ °C}$; no voltage applied; 1000 h after test: U_R to be applied for 30 min, 24 h to 48 h before measurement	$\Delta C/C: \pm 20\%$ $\tan \delta \leq 2 \times \text{spec. limit}$ $I_{L2} \leq \text{spec. limit}$



Disclaimer

ALL PRODUCT, PRODUCT SPECIFICATIONS AND DATA ARE SUBJECT TO CHANGE WITHOUT NOTICE TO IMPROVE RELIABILITY, FUNCTION OR DESIGN OR OTHERWISE.

Vishay Intertechnology, Inc., its affiliates, agents, and employees, and all persons acting on its or their behalf (collectively, "Vishay"), disclaim any and all liability for any errors, inaccuracies or incompleteness contained in any datasheet or in any other disclosure relating to any product.

Vishay makes no warranty, representation or guarantee regarding the suitability of the products for any particular purpose or the continuing production of any product. To the maximum extent permitted by applicable law, Vishay disclaims (i) any and all liability arising out of the application or use of any product, (ii) any and all liability, including without limitation special, consequential or incidental damages, and (iii) any and all implied warranties, including warranties of fitness for particular purpose, non-infringement and merchantability.

Statements regarding the suitability of products for certain types of applications are based on Vishay's knowledge of typical requirements that are often placed on Vishay products in generic applications. Such statements are not binding statements about the suitability of products for a particular application. It is the customer's responsibility to validate that a particular product with the properties described in the product specification is suitable for use in a particular application. Parameters provided in datasheets and/or specifications may vary in different applications and performance may vary over time. All operating parameters, including typical parameters, must be validated for each customer application by the customer's technical experts. Product specifications do not expand or otherwise modify Vishay's terms and conditions of purchase, including but not limited to the warranty expressed therein.

Except as expressly indicated in writing, Vishay products are not designed for use in medical, life-saving, or life-sustaining applications or for any other application in which the failure of the Vishay product could result in personal injury or death. Customers using or selling Vishay products not expressly indicated for use in such applications do so at their own risk. Please contact authorized Vishay personnel to obtain written terms and conditions regarding products designed for such applications.

No license, express or implied, by estoppel or otherwise, to any intellectual property rights is granted by this document or by any conduct of Vishay. Product names and markings noted herein may be trademarks of their respective owners.

Material Category Policy

Vishay Intertechnology, Inc. hereby certifies that all its products that are identified as RoHS-Compliant fulfill the definitions and restrictions defined under Directive 2011/65/EU of The European Parliament and of the Council of June 8, 2011 on the restriction of the use of certain hazardous substances in electrical and electronic equipment (EEE) - recast, unless otherwise specified as non-compliant.

Please note that some Vishay documentation may still make reference to RoHS Directive 2002/95/EC. We confirm that all the products identified as being compliant to Directive 2002/95/EC conform to Directive 2011/65/EU.

Vishay Intertechnology, Inc. hereby certifies that all its products that are identified as Halogen-Free follow Halogen-Free requirements as per JEDEC JS709A standards. Please note that some Vishay documentation may still make reference to the IEC 61249-2-21 definition. We confirm that all the products identified as being compliant to IEC 61249-2-21 conform to JEDEC JS709A standards.