

# 2014 **M**ultilayer Ceramic Capacitors Product catalog

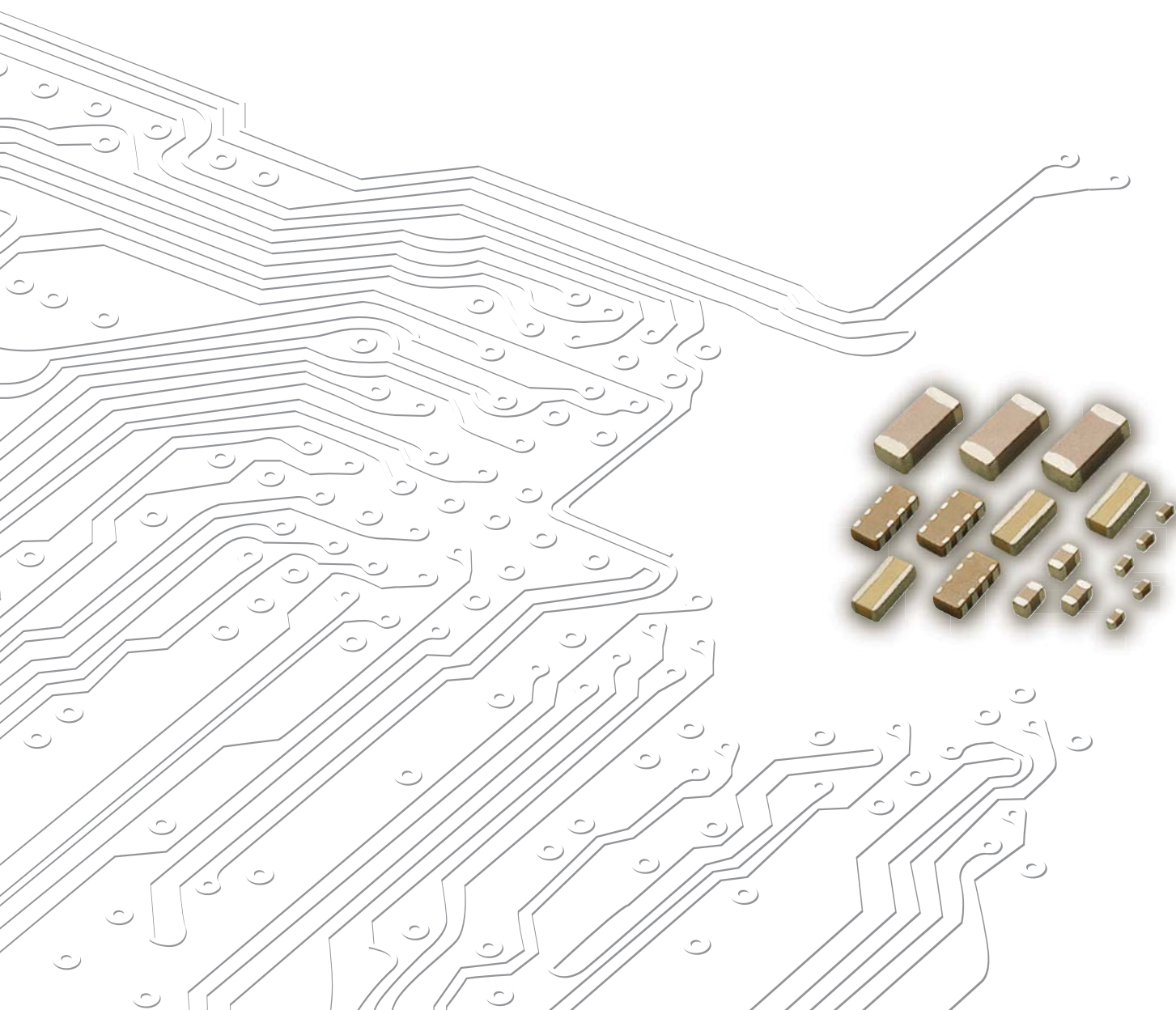

## Product Portfolio

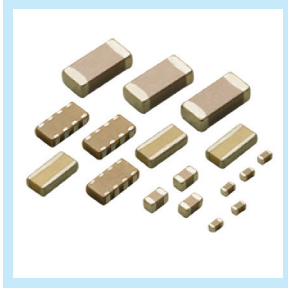

**Multilayer Ceramic Capacitors (MLCC)**

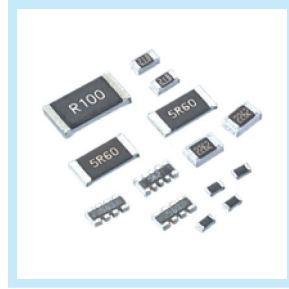

**Chip-Resistor**

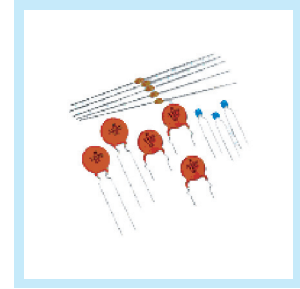

**Disc Capacitors**



**RF Device and High Frequency Inductors**

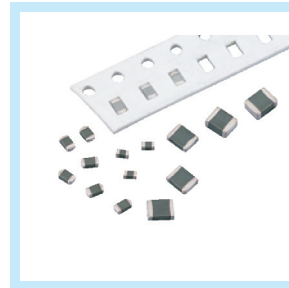

**Varistors and SMD-Varistors**

## IEC-63 Nominal Resistance / Capacitance

<b>E1</b>	100																							
<b>E3</b>	100				220					470														
<b>E6</b>	100	150	220	330	470	680																		
<b>E12</b>	100	120	150	180	220	270	330	390	470	560	680	820												
<b>E24</b>	100	110	120	130	150	160	180	200	220	240	270	300	330	360	390	430	470	510	560	620	680	750	820	910
<b>E96</b>	100	102	121	124	147	150	178	182	215	221	261	267	316	324	383	392	464	475	562	576	681	698	825	845
	105	107	127	130	154	158	187	191	226	232	274	280	332	340	402	412	487	499	590	604	715	732	866	887
	110	113	133	137	162	165	196	200	237	243	287	294	348	357	422	432	511	523	619	634	750	768	909	931
	115	118	140	143	169	174	205	210	249	255	301	309	365	374	442	453	536	549	649	665	787	806	953	976

E6:  $\sqrt[6]{10} \approx 1.46$  E12:  $\sqrt[12]{10} \approx 1.21$

E1 series resistance: 1Ω, 10Ω, 100Ω, 1000Ω, 10000Ω, 100000Ω

## INDEX

<b>Subject</b>	<b>Page</b>
Quick Product Information .....	1
How To Order and Packaging Dimension/Quantity .....	2
The Outlines and External Dimensions of Capacitors .....	3
General Purpose Caps (6.3V~100V) .....	4
Ultra-small Caps (01R5 series) .....	9
Middle & High Voltage Caps (200V~3kV) .....	10
High Q & Low ESR Caps (HH series) .....	13
Microwave Caps (RF series) .....	15
Soft Termination Capacitors (SH/SG series) .....	17
Open-mode Design Caps (OP series) .....	23
Capacitor Arrays (Y4C2/Y4C3 series) .....	25
Low Profile Caps (TT series) .....	26
Low Inductance Caps (0612 series) .....	27
Safety Certificated Caps X1/Y2 (S2 series) .....	28
Safety Certificated Caps X2/Y3 (S3 series) .....	29
Automotive Capacitor Qualified to AEC-Q200 (MT series).....	30
Automotive Caps Without AEC-Q200 Certification (MG series) .....	31
Automotive Capacitor Arrays Qualified to AEC-Q200 (MY series) .....	34
<b>Appendix  </b> : Reliability Test Conditions and Requirements .....	35
<b>Appendix   </b> : General Information .....	38

\*The specifications are subject to change or our products in it may be discontinued without advance notice. Please check with our sales representatives or product engineers before ordering.

\*This catalog has only typical specifications because there is no space for detailed specifications. Therefore, please approve our product specifications or transact the approval sheet for product specifications before ordering.

## ■ QUICK PRODUCT INFORMATION

Series	Dielectric	Size	Capacitance	Rated voltage	Page
General Purpose Caps (6.3V~100V)	NPO	0201, 0402, 0603, 0805, 1206, 1210, 1812	0.3pF~0.1μF	10V, 16V, 25V, 50V, 100V	5
	X7R	0201, 0402, 0603, 0805, 1206, 1210, 1812	100pF~47μF	6.3V, 10V, 16V, 25V, 50V, 100V	
	X6S	0402, 0603, 0805, 1206,1210	0.47μF~100μF	6.3V, 10V, 16V, 25V	
	X5R	0201, 0402, 0603, 0805, 1206,1210	0.027μF~100μF	6.3V, 10V, 16V, 25V,50V	
	Y5V	0402, 0603, 0805, 1206, 1210, 1812	0.01μF~100μF	6.3V, 10V, 16V, 25V, 50V, 100V	
Ultra-small Caps (01R5 series)	NPO	01005	0.2pF~100pF	16V	9
	X7R	01005	100pF~1000pF	10V	
	X5R	01005	1000pF~0.1μF	6.3V,10V	
Middle & High Voltage Caps (200V~3kV)	NPO	0603, 0805, 1206, 1210, 1808, 1812	0.5pF~6800pF	200V, 250V, 500V, 630V, 1kV, 2kV, 3kV	11
	X7R	0603, 0805, 1206, 1210, 1808, 1812	100pF~1μF	200V, 250V, 500V, 630V, 1kV, 2kV, 3kV	
	Y5V	0805, 1206, 1210,1812	0.01μF~0.68μF	200V, 250V	
High Q & Low ESR Caps (HH series)	NPO	0402, 0603,0805	0.1pF~3300pF	16V, 25V, 50V, 100V, 200V, 250V, 500V, 630V	14
Microwave Caps (RF series)	NPO	0201, 0402,0603,0805	0.1pF~100pF	6.3V, 10V, 25V, 50V,100V,500V	16
Soft Termination Capacitors (SH/ SG series)	NPO	0402,0603,1206, 1210,1808	0.5pF~0.015μF	10V,16V,25V,50V,100V,200V,250V,500V, 630V,1KV,3KV	18
	X7R	0402,0603, 0805, 1206, 1210, 1808, 1812	100pF~10μF	10V,16V,25V,50V,100V,200V,250V,500V, 630V, 1kV,2kV, 3kV	
Open-mode Design Caps (OP series)	X7R	0805, 1206, 1210, 1812	100pF~1μF	100V, 200V, 250V, 500V	23
Capacitor Arrays (Y4C2/Y4C3 series)	NPO	0508 (4x0402), 0612 (4x0603)	10pF~470pF	25V, 50V,100V	25
	X7R	0508 (4x0402), 0612 (4x0603)	180pF~0.1μF	10V, 16V, 25V, 50V	
	Y5V	0612 (4x0603)	0.01μF~0.1μF	16V, 50V	
Low Profile Caps (TT series)	X7R	0805, 1206	0.22μF~4.7μF	10V, 16V, 25V, 50V	26
	X5R	0603, 0805, 1206, 1210	0.22μF~22μF	6.3V, 10V, 16V, 25V,50V	
	Y5V	0805, 1206, 1210	1μF~10μF	10V, 16V, 25V, 50V	
Low Inductance Caps (0612 series)	X7R	0612	0.01μF~0.15μF	50V	27
Safety Certificated Caps X1/Y2 (S2 series)	NPO	1808, 1812, 2211	4pF~680pF	250Vac	28
	X7R	1808, 1812,2220, 2211	100pF~4700pF	250Vac	
Safety Certificated Caps X2/Y3 (S3 series)	NPO	1808, 1812	3.9pF~1000pF	250Vac	29
	X7R	1808, 1812	150pF~5600pF	250Vac	
Automotive Capacitor Qualified to AEC-Q200 (MT series)	NPO	0402, 0603, 0805, 1206,	0.5pF~0.01μF	10V,16V,25V,50V,100V	30
	X7R	0402, 0603, 0805, 1206,	100pF~1μF	10V,16V,25V,50V,100V	
Automotive Caps Without AEC-Q200 Certification (MG series)	NPO	0402, 0603, 0805, 1206, 1210, 1812	0.5pF~0.033μF	10V,16V,25V,50V,100V,200V,250V	31
	X7R	0402, 0603, 0805, 1206, 1210, 1812	100pF~2.2μF	10V,16V,25V,50V,100V,200V,250V	
	X5R	0402, 0603, 0805, 1206, 1210	0.056μF~10μF	6.3V,10V,16V,25V	
Automotive Capacitor Arrays Qualified AEC-Q200 (MY Series)	NPO	0508 (4x0402)	10pF~220pF	50V	34
	X7R	0508 (4x0402)	1000pF~0.1μF	10V, 16V, 25V	

## HOW TO ORDER

Type of MLCC	0805		B	104	K	500	C	T
	Size		Dielectric	Capacitance	Tolerance	Rated voltage	Termination	Packaging
General Purpose MLCC Middle & High Voltage MLCC Ultra-small MLCC	Inch (mm) : 0201 (0603), 0603 (1608), 1206 (3216), 1808 (4520),		N=NP0 B=X7R S=X6S X=X5R F=Y5V	Two significant digits followed by no. of zeros. And R is in place of decimal point.  R47=0.47pF 0R5=0.5pF 1R0=1pF 100=10pF 101=100pF 102=1000pF 103=0.01uF 104=0.1uF 105=1uF 106=10uF 107=100uF	A= ±0.05pF B= ±0.1pF C= ±0.25pF D= ±0.5pF F= ±1% G= ±2% J= ±5% K= ±10% M= ±20% Z= -20/+80%	Two significant digits followed by no. of zeros. And R is in place of decimal point.  4R0=4 Vdc 6R3=6.3 Vdc 100=10 Vdc 160=16 Vdc 250=25 Vdc 500=50 Vdc 101=100 Vdc 201=200 Vdc 251=250 Vdc 501=500 Vdc 631=630 Vdc 102=1k Vdc 202=2k Vdc 302=3k Vdc 502=5k Vdc 602=6k Vdc	L=Ag/Ni/Sn C=Cu/Ni/Sn Termination  L=Ag/Ni/Sn C=Cu/Ni/Sn P=Cu/Polymer Ni/Sn	B=Bulk C=Bulk cassette T=7" reeled Q=10" reeled G=13" reeled
Low Inductance MLCC	0612 (1632)							
High Q / Low ESR MLCC Microwave MLCC Low Profile MLCC Open Mode MLCC Safety Certificated MLCC Low Distortion MLCC Automotive MLCC	RF	03						
	Series		Size					
	HH=High Q/ Low ESR RF=Microwave TT=Low profile OP=Open-mode design S2=X1/Y2 safety class S3=X2/Y3 safety class LD= Low distortion MG=Automotive Cap. without AEC-Q200 MT=Automotive Cap. with AEC-Q200 MY=Automotive Array with AEC-Q200		Inch : 02=01005 03=0201 15=0402 11=0505 18=0603 21=0805 12=0508 31=1206 32=1210 42=1808 43=1812 52=2211 55=2220					
	Soft Termination MLCC	SH=With Ag polymer SG=With Cu polymer						
Cap Arrays MLCC	Y	4 C	3					
	Type	Cap. Nr.	Termination pitch					
	Y=Capacitor array	4C=4xCap	3=0.03 inch 2=0.02 inch					

\* The packaging code per each size of reel, please refer to following table "packaging style and quantity".

## PACKAGING STYLE AND QUANTITY

Size	Thickness (mm)/Symbol		Paper tape		Plastic tape	
			7" reel	13" reel	7" reel	13" reel
01005 (0402)	0.20±0.02	V	20,000	-	-	-
0201 (0603)	0.30±0.03	L	15,000	70,000	-	-
0402 (1005)	0.50±0.05	N	10,000	50,000	-	-
	0.50±0.02/-0.05	Q	10,000	50,000	-	-
0603 (1608)	0.50±0.10	H	4,000	-	-	-
	0.80±0.07	S	4,000	15,000	-	-
	0.80±0.15/-0.10	X	4,000	15,000	-	-
0805 (2012)	0.50±0.10	H	4,000	15,000	-	-
	0.60±0.10	A	4,000	15,000	-	-
	0.80±0.10	B	4,000	15,000	-	-
	0.85±0.10	T	4,000	15,000	-	-
	1.25±0.10	D	-	-	3,000	10,000
1206 (3216)	1.25±0.20	I	-	-	3,000	10,000
	0.80±0.10	B	4,000	15,000	-	-
	0.85±0.10	T	4,000	15,000	-	-
	0.95±0.10	C	-	-	3,000	10,000
	1.15±0.15	J	-	-	3,000	10,000
	1.25±0.10	D	-	-	3,000	10,000
	1.60±0.20	G	-	-	2,000	10,000
1.60±0.30/-0.10	P	-	-	2,000	9,000	
1210 (3225)	0.85±0.10	T	-	-	3,000	10,000
	0.95±0.10	C	-	-	3,000	10,000
	1.25±0.10	D	-	-	3,000	10,000
	1.60±0.20	G	-	-	2,000	-
	2.00±0.20	K	-	-	1,000	6,000
	2.50±0.30	M	-	-	1,000	6,000
1808 (4520)	1.25±0.10	D	-	-	2,000	10,000
	1.10±0.15	F	-	-	2,000	10,000
	1.60±0.20	G	-	-	2,000	8,000
1812 (4532)	2.00±0.20	K	-	-	1,000	6,000
	2.50±0.30	M	-	-	1,000	6,000
	1.25±0.10	D	-	-	1,000	5,000
	1.60±0.20	G	-	-	1,000	-
	2.00±0.20	K	-	-	1,000	-
1812 (4532)	2.50±0.30	M	-	-	500	3,000
	2.80±0.30	U	-	-	500	-

# The Outlines and External Dimensions of Capacitor

## ■ SINGLE CHIP CAPACITORS

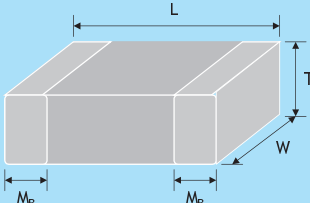
Outline	Size Inch (mm)	L (mm)	W (mm)	T (mm)/Symbol	SolderingMethod *	M <sub>B</sub> (mm)	
	01005 (0402)	0.40±0.02	0.20±0.02	0.20±0.02	V	R	0.10±0.03
	0201 (0603)	0.6±0.03	0.3±0.03	0.3±0.03	L	R	0.15±0.05
		0.6±0.05 <sup>#2</sup>	0.3±0.05 <sup>#2</sup>	0.3±0.05 <sup>#2</sup>			
	0402 (1005)	1.00±0.05	0.50±0.05	0.50±0.05	N	R	0.25±0.05/-0.10
		1.00±0.20	0.50±0.20	0.50±0.20	Q	R	
	0603 (1608)	1.60±0.10	0.80±0.10	0.80±0.07	S	R / W	0.40±0.15
		1.60±0.15/-0.10	0.80±0.15/-0.10	0.50±0.10	H	R / W	
				0.80±0.15/-0.10	X	R / W	
		1.60±0.20 <sup>#1</sup>	0.80±0.20 <sup>#1</sup>	0.80±0.20 <sup>#1</sup>			
	0805 (2012)	2.00±0.15	1.25±0.10	0.50±0.10	H	R / W	0.50±0.20
				0.60±0.10	A	R / W	
				0.80±0.10	B	R / W	
		1.25±0.10	D	R			
		2.00±0.20	1.25±0.20	0.85±0.10	T	R / W	
				1.25±0.20	I	R	
	1206 (3216)	3.20±0.15	1.60±0.15	0.80±0.10	B	R / W	0.60±0.20 (0.5±0.25) <sup>***</sup>
				0.95±0.10	C	R	
				1.25±0.10	D	R	
		3.20±0.20	1.60±0.20	1.15±0.15	J	R	
				1.60±0.20	G	R	
				0.85±0.10	T	R / W	
	3.20 +0.30/-0.10	1.60 +0.30/-0.10	1.60+0.30/-0.10	P	R		
	1210 (3225)	3.20±0.30	2.50±0.20	0.95±0.10	C	R	0.75±0.25
0.85±0.10				T	R		
1.25±0.10				D	R		
3.20±0.40		2.50±0.30	1.60±0.20	G	R		
			2.00±0.20	K	R		
2.50±0.30	M	R					
1808 (4520)	4.50±0.40 (4.5+0.5/-0.3) <sup>**</sup>	2.03±0.25	1.25±0.10	D	R	0.75±0.25 (0.5±0.25) <sup>***</sup>	
			1.40±0.15	F	R		
			1.60±0.20	G	R		
			2.00±0.20	K	R		
1812 (4532)	4.50±0.40 (4.5+0.5/-0.3) <sup>**</sup>	3.20±0.30	1.25±0.10	D	R	0.75±0.25 (0.5±0.25) <sup>***</sup>	
			1.60±0.20	G	R		
		3.20±0.40	2.00±0.20	K	R		
			2.50±0.30	M	R		
			2.80±0.30	U	R		

\* R = Reflow soldering process ; W = Wave soldering process.

\*\* For 1808\_200~3kV, 1812\_200V~3kV and safety certificated products.

\*\*\* For 1206\_1000V ~3kV, 1808\_200~3kV, 1812\_200~3kV and safety certificated products.

#1 : For 0603/X5R/X6S/6.3V/Cap≥10μF products.

#2 : For 0201/Cap≥0.68μF products.

Soft termination product please refer to individual sheet for detail.

## ■ Capacitor Arrays

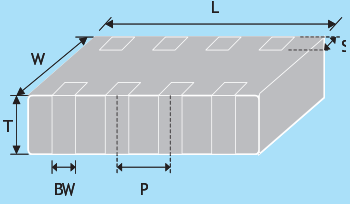
Outline	Size Inch (mm)	L (mm)	W (mm)	T (mm)/Symbol	S (mm)	BW (mm)	P (mm)	
	0603 x 4 (0612 (1632))	3.20±0.15	1.60±0.15	0.80±0.10	B	0.30±0.20	0.40±0.15	0.80±0.15
	0402 x 4 (0508 (1220))	2.00±0.15	1.25±0.15	0.85±0.10	T	0.20±0.10	0.25±0.10	0.50±0.10

Reflow soldering process only.

## ■ Low Inductance Capacitors / RF series

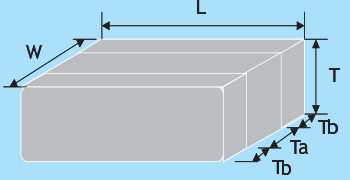
Outline	Size Inch (mm)	L (mm)	W (mm)	T (mm)/Symbol	T <sub>a</sub> min. (mm)	T <sub>b</sub> min. (mm)	
	0612 (1632)	3.20±0.15	1.60±0.15	0.80±0.10	B	0.5	0.13
	0508 (1220)	2.00±0.15	1.25±0.15	0.85±0.10	T	0.38	0.13

Reflow soldering process only.

### FEATURES

- \* A wide selection of sizes is available (0402 to 1812).
- \* High capacitance in given case size.
- \* Capacitor with lead-free termination (pure Tin).

### GENERAL ELECTRICAL DATA

Dielectric	NPO	X7R	X6S	X5R	Y5V
Size	0201, 0402, 0603, 0805, 1206, 1210, 1812				
Capacitance range	0.3pF to 0.1 $\mu$ F	100pF to 47 $\mu$ F	0.47 $\mu$ F to 100 $\mu$ F	0.027 $\mu$ F to 100 $\mu$ F	0.01 $\mu$ F to 100 $\mu$ F
Capacitance tolerance	Cap $\leq$ 5pF: B ( $\pm$ 0.1pF), C ( $\pm$ 0.25pF) 5pF<Cap<10pF: C ( $\pm$ 0.25pF), D ( $\pm$ 0.5pF) Cap $\geq$ 10pF: F ( $\pm$ 1%), G ( $\pm$ 2%), J ( $\pm$ 5%),K ( $\pm$ 10%)	J ( $\pm$ 5%), K ( $\pm$ 10%), M ( $\pm$ 20%)	K ( $\pm$ 10%), M ( $\pm$ 20%)	K ( $\pm$ 10%), M ( $\pm$ 20%)	M ( $\pm$ 20%), Z (-20/+80%)
Rated voltage (WVDC)	10V, 16V, 25V, 50V, 100V	6.3V, 10V, 16V, 25V, 50V, 100V			
Operating temperature	-55 to +125 $^{\circ}$ C		-55 to +105 $^{\circ}$ C	-55 to +85 $^{\circ}$ C	-25 to +85 $^{\circ}$ C
Capacitance characteristic	$\pm$ 30ppm	$\pm$ 15%	$\pm$ 22%	$\pm$ 15%	+30/-80%
Termination	Ni/Sn (lead-free termination)				

### EXPLANATION OF PART NUMBERS

1206	F	104	Z	500	C	T
<b>Size (Inch (mm))</b> 1206 (3216)	<b>Dielectric</b> F=Y5V	<b>Capacitance</b> 104=10x10 <sup>4</sup> =100nF	<b>Tolerance</b> Z=-20/+80%	<b>Rated voltage</b> 500=50 VDC	<b>Termination</b> C=Cu/Ni/Sn	<b>Packaging style</b> T=7 <sup>th</sup> reeled

Please refer to page 2 "How to order" for more information.

### ELECTRICAL CHARACTERISTICS

#### 1) Frequency characteristics

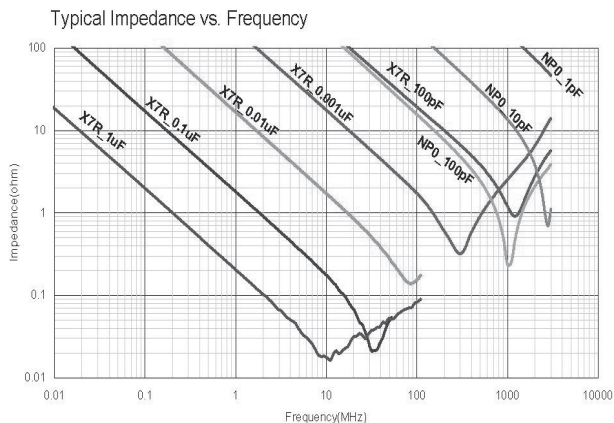

#### 2) Capacitance Change - Typical aging rate

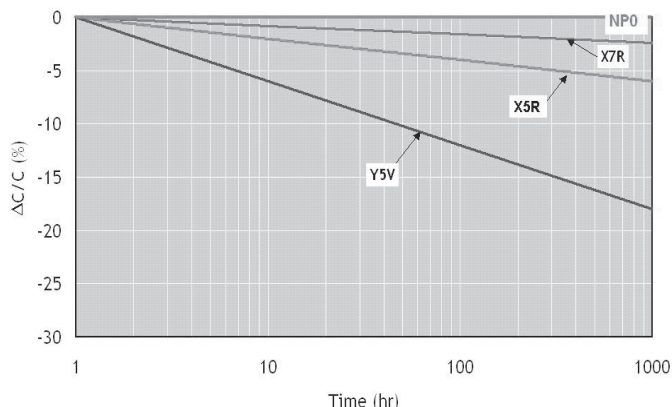

#### 3) Temperature characteristics of capacitance (TCC)

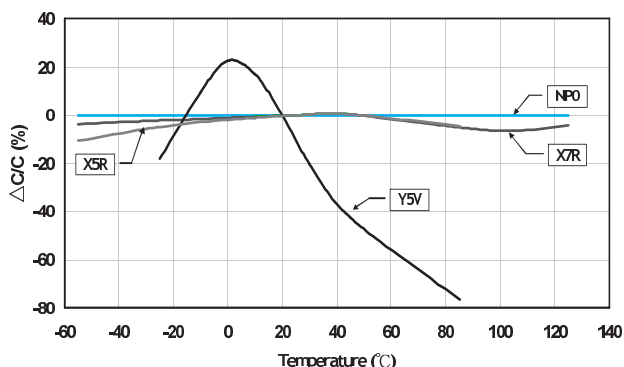

#### 4) DC Bias characteristics

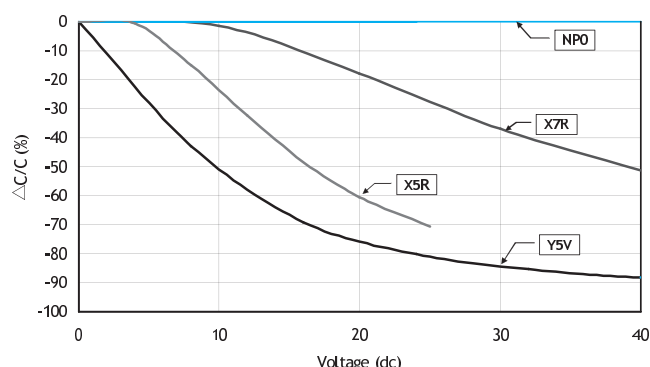

# General Purpose Capacitors

## 6.3V~100V

### ■ CAPACITANCE RANGE

NP0 Dielectric

Dielectric	NP0																									
	Size		0201		0402		0603		0805				1206				1210			1812						
	Rated Voltage (VDC)	16 25	50	10 16 25 50	100	10 16 25 50	100	10	16	25	50	100	10	16	25	50	100	10	16	25	50	100	16	50	100	
capacitance	0.3pF (0R3)	L	L																							
	0.4pF (0R4)	L	L																							
	0.5pF (0R5)	L	L	N	N	S	S	A	A	A																
	0.6pF (0R6)	L	L	N	N	S	S	A	A	A																
	0.7pF (0R7)	L	L	N	N	S	S	A	A	A																
	0.8pF (0R8)	L	L	N	N	S	S	A	A	A																
	0.9pF (0R9)	L	L	N	N	S	S	A	A	A																
	1.0pF (1R0)	L	L	N	N	S	S	A	A	A																
	1.2pF (1R2)	L	L	N	N	S	S	A	A	A	B	B	B													
	1.5pF (1R5)	L	L	N	N	S	S	A	A	A	B	B	B	B												
	1.8pF (1R8)	L	L	N	N	S	S	A	A	A	B	B	B	B												
	2.0pF (2R0)	L	L	N	N	S	S	A	A	A	B	B	B	B												
	2.2pF (2R2)	L	L	N	N	S	S	A	A	A	B	B	B	B												
	2.7pF (2R7)	L	L	N	N	S	S	A	A	A	B	B	B	B												
	3.0pF (3R0)	L	L	N	N	S	S	A	A	A	B	B	B	B												
	3.3pF (3R3)	L	L	N	N	S	S	A	A	A	B	B	B	B												
	3.9pF (3R9)	L	L	N	N	S	S	A	A	A	B	B	B	B												
	4.0pF (4R0)	L	L	N	N	S	S	A	A	A	B	B	B	B												
	4.7pF (4R7)	L	L	N	N	S	S	A	A	A	B	B	B	B												
	5.0pF (5R0)	L	L	N	N	S	S	A	A	A	B	B	B	B												
	5.6pF (5R6)	L	L	N	N	S	S	A	A	A	B	B	B	B												
	6.0pF (6R0)	L	L	N	N	S	S	A	A	A	B	B	B	B												
	6.8pF (6R8)	L	L	N	N	S	S	A	A	A	B	B	B	B												
	7.0pF (7R0)	L	L	N	N	S	S	A	A	A	B	B	B	B												
	8.0pF (8R0)	L	L	N	N	S	S	A	A	A	B	B	B	B												
	8.2pF (8R2)	L	L	N	N	S	S	A	A	A	B	B	B	B												
	9.0pF (9R0)	L	L	N	N	S	S	A	A	A	B	B	B	B												
	10pF (100)	L	L	N	N	S	S	A	A	A	B	B	B	B	C	C	C							D	D	D
	12pF (120)	L	L	N	N	S	S	A	A	A	B	B	B	B	C	C	C	C						D	D	D
	15pF (150)	L	L	N	N	S	S	A	A	A	B	B	B	B	C	C	C	C						D	D	D
	18pF (180)	L	L	N	N	S	S	A	A	A	B	B	B	B	C	C	C	C						D	D	D
	22pF (220)	L	L	N	N	S	S	A	A	A	B	B	B	B	C	C	C	C						D	D	D
	27pF (270)	L	L	N	N	S	S	A	A	A	B	B	B	B	C	C	C	C						D	D	D
	33pF (330)	L	L	N	N	S	S	A	A	A	B	B	B	B	C	C	C	C						D	D	D
	39pF (390)	L	L	N	N	S	S	A	A	A	B	B	B	B	C	C	C	C						D	D	D
	47pF (470)	L	L	N	N	S	S	A	A	A	B	B	B	B	C	C	C	C						D	D	D
	56pF (560)	L	L	N	N	S	S	A	A	A	B	B	B	B	C	C	C	C						D	D	D
	68pF (680)	L	L	N	N	S	S	A	A	A	B	B	B	B	C	C	C	C						D	D	D
	82pF (820)	L	L	N	N	S	S	A	A	A	B	B	B	B	C	C	C	C						D	D	D
	100pF (101)	L	L	N	N	S	S	A	A	A	B	B	B	B	C	C	C	C						D	D	D
	120pF (121)	L	L	N	N	S	S	A	A	A	B	B	B	B	C	C	C	C						D	D	D
	150pF (151)			N	N	S	S	A	A	A	B	B	B	B	C	C	C	C						D	D	D
	180pF (181)			N	N	S	S	A	A	A	B	B	B	B	C	C	C	C						D	D	D
	220pF (221)			N	N	S	S	A	A	A	B	B	B	B	C	C	C	C						D	D	D
	270pF (271)			N	N	S	S	A	A	A	B	B	B	B	C	C	C	C						D	D	D
	330pF (331)			N	N	S	S	A	A	A	B	B	B	B	C	C	C	C						D	D	D
	390pF (391)			N	N	S	S	B	B	B	B	B	B	B	C	C	C	C						D	D	D
	470pF (471)			N	N	S	S	B	B	B	B	B	B	B	C	C	C	C						D	D	D
	560pF (561)			N	N	S	S	B	B	B	B	B	B	B	C	C	C	C						D	D	D
	680pF (681)			N	N	S	S	B	B	B	B	B	B	B	C	C	C	C						D	D	D
	820pF (821)			N	N	S	S	B	B	B	B	B	B	B	C	C	C	C						D	D	D
	1,000pF (102)			N	N	S	S	B	B	B	B	B	B	B	C	C	C	C						D	D	D
	1,200pF (122)					X	X	B	B	B	B	B	B	B	C	C	C	C						D	D	D
	1,500pF (152)					X	X	B	B	B	B	B	B	B	C	C	C	C						D	D	D
	1,800pF (182)					X	X	B	B	B	B	B	B	B	C	C	C	C						D	D	D
	2,200pF (222)					X	X	B	B	B	B	B	B	B	C	C	C	C						D	D	D
	2,700pF (272)					X	X	D	D	D	B	B	B	B	C	C	C	C						D	D	D
	3,300pF (332)					X	X	D	D	D	B	B	B	B	C	C	C	C						D	D	D
	3,900pF (392)					X	X	D	D	D	B	B	B	B	C	C	C	C						D	D	D
	4,700pF (472)					X	X	D	D	D	B	B	B	B	C	C	C	C						D	D	D
5,600pF (562)					X	X	D	D	D	B	B	B	B	C	C	C	C						D	D	D	
6,800pF (682)					X	X	D	D	D	C	C	C	C	C	C	C	C						D	D	D	
8,200pF (822)					X	X	D	D	D	D	D	D	D	C	C	C	C						D	D	D	
0.010uF (103)					X	X	D	D	D	D	D	D	D	C	C	C	C						D	D	D	
0.012uF (123)							T	T	T	T	T	T	T	D	D	D	D						D	D	D	
0.015uF (153)							T	T	T	T	T	T	T	D	D	D	D						D	D	D	
0.018uF (183)							D	D	D	T	T	T	T										D	D	D	
0.022uF (223)							D	D	D	T	T	T	T										D	D	D	
0.027uF (273)										T	T	T	T										D	D	D	
0.033uF (333)										T	T	T	T										D	D	D	
0.039uF (393)										J	J	J	J													
0.056uF (563)										J	J	J	J													
0.068uF (683)										G	G	G	G													
0.082uF (823)										G	G	G	G													
0.1uF (104)										G	G	G	G													

1. The letter in cell is expressed the symbol of product thickness.

2. For more information about products with special capacitance or other data, please contact WTC local representative.





# General Purpose Capacitors

## 6.3V~100V

### Y5V Dielectric (0402, 0603, 0805 Size)

Dielectric		Y5V															
Size		0402					0603					0805					
Rated Voltage (VDC)		6.3	10	16	25	50	6.3	10	16	25	50	6.3	10	16	25	50	100
capacitance	0.010uF (103)		N	N	N	N		S	S	S	S		A	A	A	A	B
	0.015uF (153)		N	N	N	N		S	S	S	S		A	A	A	A	B
	0.022uF (223)		N	N	N	N		S	S	S	S		A	A	A	A	B
	0.033uF (333)		N	N	N	N		S	S	S	S		A	A	A	A	B
	0.047uF (473)		N	N	N			S	S	S	S		A	A	A	A	B
	0.068uF (683)		N	N	N			S	S	S	S		A	A	A	A	B
	0.10uF (104)		N	N	N			S	S	S	S		A	A	A	A	B
	0.15uF (154)		N	N				S	S	S	S		A	A	A	A	
	0.22uF (224)	N	N	N			S	S	S	S	S		A	A	A	A	
	0.33uF (334)	N	N	N			S	S	S	X		B	B	B	B		
	0.47uF (474)	N	N	N			S	S	X	X		B	B	B	B/D		
	0.68uF (684)	N					S	X	X			B	B	D	D		
	1.0uF (105)	N	N				S	X	X			B	B	D	D		
	1.5uF (155)						S					D	D				
	2.2uF (225)						S	S	X			D	D	I			
	3.3uF (335)											D	D				
	4.7uF (475)						X	X				D	D	I			
	6.8uF (685)											I					
10uF (106)											I	I	I				
22uF (226)											I	I					

### Y5V Dielectric (1206, 1210, 1812 Size)

Dielectric		Y5V																		
Size		1206						1210						1812						
Rated Voltage (VDC)		6.3	10	16	25	35	50	100	6.3	10	16	25	35	50	100	10	16	25	50	100
capacitance	0.010uF (103)		B	B	B		B	B							C					D
	0.015uF (153)		B	B	B		B	B							C					D
	0.022uF (223)		B	B	B		B	B							C					D
	0.033uF (333)		B	B	B		B	B							C					D
	0.047uF (473)		B	B	B		B	B							C					D
	0.068uF (683)		B	B	B		B	B							C					D
	0.10uF (104)		B	B	B		B	B	C	C	C			C	C	D	D	D	D	D
	0.15uF (154)		B	B	B		B	C	C	C	C			C	C	D	D	D	D	D
	0.22uF (224)		B	B	B		B	C	C	C	C			C	C	D	D	D	D	D
	0.33uF (334)		B	B	B		B		C	C	C			C	C	D	D	D	D	D
	0.47uF (474)		B	B	B		B		C	C	C			C		D	D	D	D	D
	0.68uF (684)		B	B	B		B		C	C	C			C		D	D	D	D	D
	1.0uF (105)		C	C	C		C/D		C	C	C			C		D	D	D	D	D
	1.5uF (155)		C	C	C				C	C	C					D	D	D	D	
	2.2uF (225)		C	C	C		J		C	C	C			G		D	D	D	D	
	3.3uF (335)		J	J	J				C	C	C					D	D	D	D	
	4.7uF (475)		J	J	J	J	P		C	C	D			G		D	D	D	D	
	6.8uF (685)		J	J					C	C	D					D	D	D	D	
10uF (106)		J	J	P				D	D	G	K				D	D	D	K		
22uF (226)		P	P						K	K										
47uF (476)	P							K	K							M				
100uF (107)								M												

1. The letter in cell is expressed the symbol of product thickness.

2. For more information about products with special capacitance or other data, please contact WTC local representative.

### X5R Dielectric

Dielectric		X5R																																	
Size		0201				0402				0603					0805					1206					1210										
Rated Voltage (VDC)		6.3	10	16	25	6.3	10	16	25	6.3	10	16	25	50	6.3	10	16	25	50	6.3	10	16	25	50	6.3	10	16	25	50	6.3	10	16	25	50	
capacitance	100pF (101)	L	L	L	L																														
	220pF (221)	L	L	L	L																														
	470pF (471)	L	L	L	L																														
	1000pF (102)	L	L	L	L																														
	2200pF (222)	L	L	L																															
	4700pF (472)	L	L	L																															
	0.010μF (103)	L	L																																
	0.027μF (273)	L	L							N																									
	0.033μF (333)	L	L							N																									
	0.039μF (393)	L	L							N																									
	0.047μF (473)	L	L							N																									
	0.056μF (563)	L	L							N	N																								
	0.068μF (683)	L	L							N	N																								
	0.082μF (823)	L	L							N	N	N																							
	0.10μF (104)	L	L	L						N	N	N	N																						
	0.15μF (154)	L								N	N	N	N																						
	0.22μF (224)	L	L							N	N	N	N		X	X	X																		
	0.27μF (274)	L													X	X	X																		
	0.33μF (334)	L								N	N				X	X	X	X																	
	0.39μF (394)	L													X	X	X																		
	0.47μF (474)	L								N	N				X	X	X	X																	
	0.68μF (684)	L								N	N				X	X	X																		
	0.82μF (824)	L													X	X	X																		
	1.0μF (105)	L	L							N	N	N	N	X	X	X	X	X		D	D	D	I												
	1.5μF (155)													X						I	I	I	I			J	J				K	K			
	2.2μF (225)									N	N	E		X	X	X	X			I	I	I	I			J	J	P			K	K			
	3.3μF (335)													X	X					I	I	I	I			P	P	P							
	4.7μF (475)									E	E			X	X	X				I	I	I	I	I	P	P	P	P	P		K	K	K		
6.8μF (685)																								P	P										
10μF (106)									E				X	X	X				I	I	I	I		P	P	P	P		K	K	K	K	M		
22μF (226)													X						I	I	I			P	P	P	P		M	M	M	M			
47μF (476)																			I					P	P				M	M	M				
100μF (107)																								P					M	M					

- The letter in cell is expressed the symbol of product thickness.
- For more information about products with special capacitance or other data, please contact WTC local representative.

### X6S Dielectric

Dielectric		X6S																																		
Size		0402				0603					0805					1206					1210															
Rated Voltage (VDC)		6.3	10	16	25	4	6.3	10	25	50	4	6.3	16	25	50	6.3	10	16	25	50	6.3	10	16	25	50	6.3	10	16	25	50						
capacitance	0.10μF (104)																																			
	0.15μF (154)																																			
	0.22μF (224)																																			
	0.33μF (334)																																			
	0.47μF (474)	N																																		
	0.68μF (684)																																			
	1.0μF (105)	N																																		
	1.5μF (155)																																			
	2.2μF (225)	N	E																																	
	3.3μF (335)																																			
	4.7μF (475)									X												I														
	6.8μF (685)																																			
	10μF (106)																					I	I						G							
	22μF (226)									X												I						P	P							
47μF (476)																										P										
100μF (107)																																		M		

- The letter in cell is expressed the symbol of product thickness.
- For more information about products with special capacitance or other data, please contact WTC local representative.

# Ultra-small Capacitors

## 01R5 Series

### FEATURES

- \* High capacitance in unit size.
- \* High precision dimensional tolerances.
- \* Suitable used in high-accuracy automatic mounting machine.

### GENERAL ELECTRICAL DATA

Size	01R5		
Dielectric	NP0	X7R	X5R
Capacitance*	0.2pF to 100pF	100pF & 1000pF	1000pF to 0.1μF
Capacitance tolerance**	K (±10%), M (±20%) Cap≤10pF: C (±0.25pF) Cap>10pF: J (±5%)		
Rated voltage (WVDC)	16V	10V	6.3V, 10V
Operating temperature	-55 to +125°C	-55 to +125°C	-55 to +85°C
Capacitance change	±30ppm	±15%	
Termination	Ni/Sn (lead-free termination)		

### EXPLANATION OF PART NUMBERS

01R5	N	100	J	160	C	T
<b>Size (Inch (mm))</b>	<b>Dielectric</b>	<b>Capacitance</b>	<b>Tolerance</b>	<b>Rated voltage</b>	<b>Termination</b>	<b>Packaging style</b>
01R5 =01005 (0402)	N=NP0(C0G)	100=10x10 <sup>0</sup> =10pF	J=±5%	160=16 VDC	C=Cu/Ni/Sn	T=7" reeled

Please refer to page 2 "How to order" for more information.

### CAPACITANCE RANGE

SIZE	01R5
DIELECTRIC	NP0
RATED VOLTAGE (VDC)	16
0.2pF (0R2)	V
0.3pF (0R3)	V
0.4pF (0R4)	V
0.5pF (0R5)	V
1.0pF (1R0)	V
1.5pF (1R5)	V
2.0pF (2R0)	V
3.0pF (3R0)	V
4.0pF (4R0)	V
5.0pF (5R0)	V
6.0pF (6R0)	V
7.0pF (7R0)	V
8.0pF (8R0)	V
9.0pF (9R0)	V
10pF (100)	V
12pF (120)	V
15pF (150)	V
18pF (180)	V
22pF (220)	V
27pF (270)	V
33pF (330)	V
39pF (390)	V
47pF (470)	V
56pF (560)	V
68pF (680)	V
82pF (820)	V
100pF (101)	V

SIZE	01R5
DIELECTRIC	X7R
RATED VOLTAGE (VDC)	10
100pF (101)	V
120pF (121)	
150pF (151)	V
180pF (181)	
220pF (221)	V
270pF (271)	
330pF (331)	V
390pF (391)	
470pF (471)	V
560pF (561)	
680pF (681)	
820pF (821)	
1,000pF (102)	V

SIZE	01R5	
DIELECTRIC	X5R	
RATED VOLTAGE (VDC)	6.3	10
1,000pF (102)	V	V
1,500pF (152)		V
2,200pF (222)		V
3,300pF (332)		V
4,700pF (472)		V
6,800pF (682)		V
0.010μF (103)	V	V
0.015μF (153)		
0.022μF (223)	V	
0.033μF (333)	V	
0.047μF (473)	V	
0.068μF (683)	V	
0.10μF (104)	V	

1. The letter in cell is expressed the symbol of product thickness.
2. For more information about products with special capacitance or other data, please contact WTC local representative.

## ■ FEATURES

- \* High voltage in a given case size.
- \* High stability and reliability.

## ■ GENERAL ELECTRICAL DATA

Dielectric	NPO	X7R	Y5V
Size	0603, 0805, 1206, 1210, 1808, 1812		0805, 1206, 1210, 1812
Capacitance	0.5pF to 6800pF	100pF to 1.0μF	0.01μF to 0.68μF
Capacitance tolerance	Cap≤5pF: C (±0.25pF) 5pF<Cap<10pF: D (±0.5pF) Cap≥10pF: J (±5%), K (±10%)	K (±10%), M (±20%)	Z (-20/+80%)
Rated voltage (WVDC)	200V to 3kV		200V, 250V
DF/ Q	Cap<30pF: Q≥400+20C Cap≥30pF: Q≥1000	≤2.5%	≤5%
Insulation resistance at Ur	Ur=200~630V: ≥10GΩ or RxC≥100Ω-F whichever is smaller Ur=1000~3000V: ≥10GΩ		
Dielectric strength	200~300V: ≥2 x WVDC 500~999V: ≥1.5 x WVDC 1000~3000V: ≥1.2 x WVDC		
Operating temperature	-55 to +125°C		-25 to +85°C
Capacitance characteristic	±30ppm	±15%	+30/-80%
Termination	Ni/Sn (lead-free termination)		

## ■ EXPLANATION OF PART NUMBERS

1808	N	100	J	202	C	T
<b>Size (Inch (mm))</b> 1808 (4520)	<b>Dielectric</b> N=NP0(C0G)	<b>Capacitance</b> 100=10x10 <sup>0</sup> =10pF	<b>Tolerance</b> J=±5%	<b>Rated voltage</b> 202=2000 VDC	<b>Termination</b> C=Cu/Ni/Sn	<b>Packaging style</b> T=7" reeled

Please refer to page 2 "How to order" for more information.

## ■ CAPACITANCE RANGE

### Y5V Dielectric 200V to 250V

DIELECTRIC		Y5V							
SIZE		0805		1206		1210		1812	
RATED VOLTAGE (VDC)		200	250	200	250	200	250	200	250
Capacitance	0.010μF (103)	B	B	B	B	C	C	D	D
	0.015μF (153)	B	B	B	B	C	C	D	D
	0.022μF (223)	B	B	B	B	C	C	D	D
	0.033μF (333)	B	B	B	B	C	C	D	D
	0.047μF (473)	B	B	B	B	C	C	D	D
	0.068μF (683)	B	B	B	B	C	C	D	D
	0.10μF (104)			B	B	C	C	D	D
	0.15μF (154)			C	C	C	C	D	D
	0.22μF (224)							D	D
	0.33μF (334)							D	D
	0.47μF (474)							D	D
	0.68μF (684)							D	D

1. The letter in cell is expressed the symbol of product thickness.

2. For more information about products with special capacitance or other data, please contact WTC local representative.

# Middle and High Voltage Capacitors 200Vto 3kV

## NP0 Dielectric 200V to 3kV

DIELECTRIC	NP0																													
	0603		0805				1206					1210					1808					1812								
	200	250	200	250	500	630	200	250	500	630	1000	2000	200	250	500	630	1000	2000	500	630	1000	2000	3000	200	250	500	630	1000	2000	3000
RATED VOLTAGE (VDC)																														
0.5pF (0R5)	S	A	A	A																										
1.0pF (1R0)	S	A	A	A																										
1.2pF (1R2)	S	A	A	A																										
1.5pF (1R5)	S	A	A	A	B	B	B	B	B																					
1.8pF (1R8)	S	A	A	A	B	B	B	B	B																					
2.2pF (2R2)	S	A	A	A	B	B	B	B	B										D	D	D									
2.7pF (2R7)	S	A	A	A	B	B	B	B	B										D	D	D									
3.3pF (3R3)	S	A	A	A	B	B	B	B	B										D	D	D									
3.9pF (3R9)	S	A	A	A	B	B	B	B	B										D	D	D									
4.7pF (4R7)	S	A	A	A	B	B	B	B	B										D	D	D									
5.6pF (5R6)	S	A	A	A	B	B	B	B	B										D	D	D									
6.8pF (6R8)	S	A	A	A	B	B	B	B	B										D	D	D									
8.2pF (8R2)	S	A	A	A	B	B	B	B	B										D	D	D									
10pF (100)	S	A	A	A	B	B	B	B	B	C	C	C	C	C				D	D	D	D	D	D	D	D	D	D	D	D	
12pF (120)	S	A	A	A	B	B	B	B	B	C	C	C	C	C				D	D	D	D	D	D	D	D	D	D	D	D	
15pF (150)	S	A	A	A	B	B	B	B	B	C	C	C	C	C				D	D	D	D	D	D	D	D	D	D	D	D	
18pF (180)	S	A	A	A	B	B	B	B	B	C	C	C	C	C				D	D	D	D	D	D	D	D	D	D	D	D	
22pF (220)	S	A	A	A	B	B	B	B	B	C	C	C	C	C				D	D	D	D	D	D	D	D	D	D	D	D	
27pF (270)	S	A	A	A	B	B	B	B	B	C	C	C	C	C				D	D	D	D	D	D	D	D	D	D	D	D	
33pF (330)	S	A	A	A	B	B	B	B	B	C	C	C	C	C				D	D	D	D	D	D	D	D	D	D	D	D	
39pF (390)	S	A	A	A	B	B	B	B	B	C	C	C	C	C				D	D	D	D	D	D	D	D	D	D	D	D	
47pF (470)	S	A	A	A	B	B	B	C	C	C	C	C	C	C				D	D	D	D	D	D	D	D	D	D	D	D	
56pF (560)	S	A	A	A	B	B	B	C	D	C	C	C	C	D				D	D	D	D	D	D	D	D	D	D	D	D	
68pF (680)	S	A	A	A	B	B	B	C	D	C	C	C	C	D				D	D	D	D	D	D	D	D	D	D	D	D	
82pF (820)	S	A	A	B	B	B	B	D	D	C	C	C	C	D				D	D	D	D	D	D	D	D	D	D	D	D	
100pF (101)	S	A	B	B	B	B	B	D	D	C	C	C	D	D				D	D	K	D	D	D	D	D	D	D	D	D	
120pF (121)	S	A	B	D	B	B	B	D	G	C	C	C	D	D				D	D	K	D	D	D	D	D	D	D	D	D	
150pF (151)	S	B	D	D	B	B	B	D	G	C	C	C	D	G				D	K	K	D	D	D	D	D	D	D	D	D	
180pF (181)	S	B	D	D	B	B	B	G	G	C	C	C	D	G				D	K	K	D	D	D	D	D	D	D	D	K	
220pF (221)	S	D	D	D	B	B	B	G	G	C	C	C	G	G				D	K	K	D	D	D	D	D	D	D	D	K	
270pF (271)	X	D	D	D	B	C	C	G		C	C	C	G					K	K	K	D	D	D	D	D	D	K	K		
330pF (331)	X	D	D	D	B	C	C	G		C	C	C	G					K	K	K	D	D	D	D	D	D	K	K		
390pF (391)	X	D	D	D	B	C	C	G		C	C	C	G					K	K		D	D	D	D	D	D	K	K		
470pF (471)	X	D	D	D	C	C	C	G		C	C	C	G					K	K		D	D	D	D	D	D	K	K	K	
560pF (561)		D	D	D	C	D	D			C	C	C						K	K		D	D	D	D	D	D	K	K		
680pF (681)		D	D	D	C	D	D			C	C	C						K	K		D	D	D	D	D	D	K	K		
820pF (821)		D	D		C	G	G			C	C	C						K			D	D	D	D	D	D	K	K		
1,000pF (102)		D			C	G	G			D	D	D						K			D	D	D	D	D	D	K	K		
1,200pF (122)					C	G	G			D	D	D									D	D	D	D	D	D	D	K		
1,500pF (152)					D	G	G			D	D	D									D	D	D	D	D	D	D	K		
1,800pF (182)					D	G	G			D	D	D									D	D	D	D	D	D	D	D		
2,200pF (222)					D	G	G			D	D										D	D	D	D	D	D	D	D		
2,700pF (272)										D	D										D	D	D	D	D	D	D	D		
3,300pF (332)										D	D										D	D	D	D	D	D	D	D		
3,900pF (392)										D	D										D									
4,700pF (472)																					D									
5,600pF (562)																					D									
6,800pF (682)																					D									

1. The letter in cell is expressed the symbol of product thickness.
2. The letter in cell with "A" mark is expressed product with Ag/Ni/Sn terminations.
3. For more information about products with special capacitance or other data, please contact WTC local representative.

### X7R Dielectric 200V to 3kV

DIELECTRIC		X7R																							
SIZE		0603			0805			1206				1210				1808					1812				
RATED VOLTAGE (VDC)		200 250	200 500	500 630	200 250	500 630	1000	2000	200 250	500 630	1000	2000	500	630	1000	2000	3000	200	250	500	630	1000	2000	3000	
Capacitance	100pF (101)	X	B	B																					
	120pF (121)	X	B	B																					
	150pF (151)	X	B	B	D	D	D	D						D		D	D								
	180pF (181)	X	B	B	D	D	D	D						D		D	D								
	220pF (221)	X	B	B	D	D	D	D					D		D		D	D							
	270pF (271)	X	B	B	D	D	D	D					D		D		D	D					D	D	
	330pF (331)	X	B	B	D	D	D	D					D		D		D	K					D	D	
	390pF (391)	X	B	B	D	D	D	D					D		D		D	K					D	D	
	470pF (471)	X	B	B	D	D	D	D					D		D		D	K					D	D	
	560pF (561)	X	B	B	D	D	D	D					D		D		D	K					D	D	
	680pF (681)	X	B	B	D	D	D	D					D		D		D	K					D	D	K
	820pF (821)	X	B	B	D	D	D	D	G				D		D		D	K					D	D	K
	1,000pF (102)	X	B	B	D	D	D	D	G	C	D	D	D		D		K	K	D		D		D	D	K
	1,200pF (122)	X	B	B	D	D	D	D	G	C	D	D			D		K		D		D		D	D	K
	1,500pF (152)	X	B	B	D	D	D	D	G	C	D	D			D		K		D		D		D	D	K
	1,800pF (182)	X	B	B	D	D	D	D	G	C	D	D			D		K		D		D		D	D	
	2,200pF (222)	X	B	B	D	D	D	D	G	C	D	D			D		K		D		D		D	D	
	2,700pF (272)	X	B	B	D	D	D			C	D	D			D				D		D		D	D	
	3,300pF (332)	X	B	B	D	D	D			C	D	D			D				D		D		D	K	
	3,900pF (392)	X	B	B	D	D	D			C	D	G			D				D		D		D	K	
	4,700pF (472)	X	B	D	D	D	D			C	D	G			D				D		D		D	K	
	5,600pF (562)	X	D	D	D	D	D			C	D	G			K				D		D		D		
	6,800pF (682)	X	D	D	D	D	D			C	D	G			K				D		D		D		
	8,200pF (822)		D	D	D	D	D			C	D	G			K				D		D		D		
	0.010μF (103)		D	D	D	D	D			C	D	G			K				D		D		D		
	0.012μF (123)		D		D	D				C	D								D		D		K		
	0.015μF (153)		D		D	D				C	D								D		D		K		
	0.018μF (183)		D		D	D				C	D								D		D				
	0.022μF (223)		D		D	G				C	D								D		D				
	0.027μF (273)				D	G				C	G								D		D				
	0.033μF (333)				G	G				C	G								D		D				
	0.039μF (393)				G	G				C	G								D		D				
	0.047μF (473)				G	G				D	G								D		D				
0.056μF (563)				G	G				D	G								D		K					
0.068μF (683)				G					G	G								D		K					
0.082μF (823)				G					G									D		K					
0.10μF (104)				G					G									D		K					
0.12μF (124)									G									D							
0.15μF (154)									M									K							
0.18μF (184)									M									K							
0.22μF (224)									M									K							
0.27μF (274)									M									K							
0.33μF (334)									M									K							
0.39μF (394)									M									K							
0.47μF (474)									M									K							
0.56μF (564)																		M							
0.68μF (684)																		M							
0.82μF (824)																		M							
1.00μF (105)																		M							

1. The letter in cell is expressed the symbol of product thickness.
2. For more information about products with special capacitance or other data, please contact WTC local representative.

## ■ FEATURES

- \* High Q and low ESR performance at high frequency.
- \* Quality improvement of telephone calls for low power loss and better performance.

## ■ GENERAL ELECTRICAL DATA

Dielectric	NPO
Size	0402, 0603, 0805
Capacitance	0402: 0.1pF to 470pF 0603: 0.5pF to 3300pF 0805: 0.5pF to 150pF
Capacitance tolerance	Cap≤5pF: B (±0.1pF), C (±0.25pF) 5pF<Cap<10pF: C (±0.25pF), D (±0.5pF) Cap≥10pF: F (±1%), G (±2%), J (±5%)
Rated voltage (WVDC)	16V, 25V, 50V, 100V, 200V, 250V, 500V, 630V
Q	Cap<30pF: Q≥400+20C Cap≥30pF: Q≥1000
Insulation resistance at Ur	≥10GΩ
Operating temperature	-55 to +125°C
Capacitance change	±30ppm
Termination	Ni/Sn (lead-free termination)

## ■ EXPLANATION OF PART NUMBERS

HH	15	N	100	G	500	C	T
<b>Series</b> HH=High Q/ Low ESR	<b>Size (Inch (mm))</b> 15=0402 (1005)	<b>Dielectric</b> N=NPO(C0G)	<b>Capacitance</b> 100=10x10 <sup>0</sup> =10pF	<b>Tolerance</b> G=±2%	<b>Rated voltage</b> 500=50 VDC	<b>Termination</b> C=Cu/Ni/Sn	<b>Packaging</b> T=7" reeled

\* Please refer to page 2 "How to order" for more information.

## ■ ELECTRICAL CHARACTERISTICS

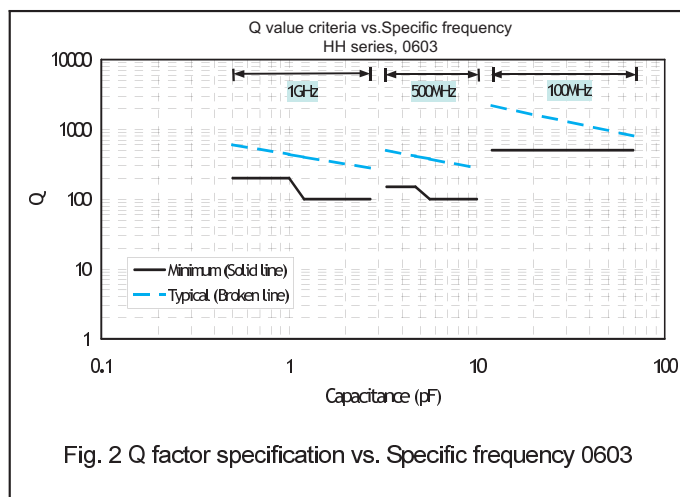
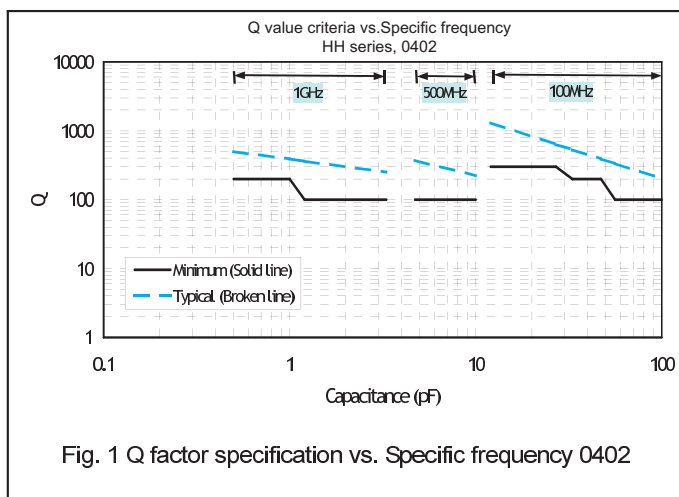



## ■ CAPACITANCE RANGE

DIELECTRIC		NPO										
		0402			0603				0805			
SIZE		16	25	50	16	25	50	100	50	100	200,250	500,630
RATED VOLTAGE (VDC)		16	25	50	16	25	50	100	50	100	200,250	500,630
Capacitance	0.1pF (0R1)	N^	N^	N^								
	0.2pF (0R2)	N^	N^	N^								
	0.3pF (0R3)	N^	N^	N^								
	0.4pF (0R4)	N^	N^	N^								
	0.5pF (0R5)	N^	N^	N^	S^	S^	S^	S^	B	B		
	0.6pF (0R6)	N^	N^	N^	S^	S^	S^	S^	B	B		
	0.7pF (0R7)	N^	N^	N^	S^	S^	S^	S^	B	B		
	0.8pF (0R8)	N^	N^	N^	S^	S^	S^	S^	B	B		
	0.9pF (0R9)	N^	N^	N^	S^	S^	S^	S^	B	B		
	1.0pF (1R0)	N^	N^	N^	S^	S^	S^	S^	B	B	B	B
	1.2pF (1R2)	N^	N^	N^	S^	S^	S^	S^	B	B	B	B
	1.5pF (1R5)	N^	N^	N^	S^	S^	S^	S^	B	B	B	B
	1.8pF (1R8)	N^	N^	N^	S^	S^	S^	S^	B	B	B	B
	2.0pF (2R0)	N^	N^	N^	S^	S^	S^	S^	B	B	B	B
	2.2pF (2R2)	N^	N^	N^	S^	S^	S^	S^	B	B	B	B
	2.7pF (2R7)	N^	N^	N^	S^	S^	S^	S^	B	B	B	B
	3.0pF (3R0)	N^	N^	N^	S^	S^	S^	S^	B	B	B	B
	3.3pF (3R3)	N^	N^	N^	S^	S^	S^	S^	B	B	B	B
	3.9pF (3R9)	N^	N^	N^	S^	S^	S^	S^	B	B	B	B
	4.0pF (4R0)	N^	N^	N^	S^	S^	S^	S^	B	B	B	B
	4.7pF (4R7)	N^	N^	N^	S^	S^	S^	S^	B	B	B	B
	5.0pF (5R0)	N^	N^	N^	S^	S^	S^	S^	B	B	B	B
	5.6pF (5R6)	N^	N^	N^	S^	S^	S^	S^	B	B	B	B
	6.0pF (6R0)	N^	N^	N^	S^	S^	S^	S^	B	B	B	B
	6.8pF (6R8)	N^	N^	N^	S^	S^	S^	S^	B	B	B	B
	7.0pF (7R0)	N^	N^	N^	S^	S^	S^	S^	B	B	B	B
	8.0pF (8R0)	N^	N^	N^	S^	S^	S^	S^	B	B	B	B
	8.2pF (8R2)	N^	N^	N^	S^	S^	S^	S^	B	B	B	B
	9.0pF (9R0)	N^	N^	N^	S^	S^	S^	S^	B	B	B	B
	10pF (100)	N	N	N	S	S	S	S	B	B	B	B
	12pF (120)	N	N	N	S	S	S	S	B	B	B	B
	15pF (150)	N	N	N	S	S	S	S	B	B	B	B
	18pF (180)	N	N	N	S	S	S	S	B	B	B	B
22pF (220)	N	N	N	S	S	S	S	B	B	B	B	
27pF (270)	N	N	N	S	S	S	S	B	B	B	B	
33pF (330)	N	N	N	S	S	S	S	B	B	B	B	
39pF (390)	N	N	N	S	S	S	S	B	B	B	B	
47pF (470)	N	N	N	S	S	S	S	B	B	B	B	
56pF (560)	N	N	N	S	S	S	S	B	B	B	B	
68pF (680)	N	N	N	S	S	S	S	B	B	B	B	
82pF (820)	N	N	N	S	S	S	S	B	B	B	B	
100pF (101)	N	N	N	S	S	S	S	B	B	B	B	
120pF (121)	N	N	N	S	S	S	S	D	D	D	D	
150pF (151)	N	N	N	S	S	S	S	D	D	D	D	
180pF (181)	N	N	N	S	S	S	S			D	D	
220pF (221)	N	N	N	S	S	S	S			D	D	
270pF (271)	N	N	N	S	S	S	S			D	D	
330pF (331)	N	N	N	S	S	S	S			D	D	
390pF (391)	N	N	N	S	S	S	S			D	D	
470pF (471)	N	N	N	S	S	S	S					
560pF (561)				S	S	S	S					
680pF (681)				S	S	S	S					
820pF (821)				S	S	S	S					
1,000pF (102)				S	S	S	S					
1,200pF (122)				X	X	X						
1,500pF (152)				X	X	X						
1,800pF (182)				X	X	X						
2,200pF (222)				X	X	X						
2,700pF (272)				X	X	X						
3,300pF (332)				X	X	X						

1. The letter in cell is expressed the symbol of product thickness.
2. The letter in cell with "A" mark is expressed product with Ag/Ni/Sn terminations.
3. For more information about products with special capacitance or other data, please contact WTC local representative.

### ■ FEATURES

- \* Ultra high Q and low ESR performance at high frequency.
- \* Quality improvement of telephone calls for low power loss and better performance.

### ■ GENERAL ELECTRICAL DATA

Dielectric	NPO
Size	0201, 0402, 0603, 0805
Capacitance	0.1pF to 100pF
Capacitance tolerance	Cap≤5pF: A (±0.05pF), B (±0.1pF), C (±0.25pF) 5pF<Cap<10pF: B (±0.1pF), C (±0.25pF), D (±0.5pF) Cap≥10pF: F (±1%), G (±2%), J (±5%)
Rated voltage (WVDC)	6.3V, 10V, 25V, 50V, 100V, 250V, 500V
Q	Cap≥30pF, Q≥1000 Cap<30pF, Q≥400+20C
Insulation resistance at Ur	≥10GΩ
Operating temperature	-55 to +125°C
Capacitance change	±30ppm/°C; 0201Cap≥22pF, ±60ppm/°C
Termination	Ni/Sn (lead-free termination)

### ■ EXPLANATION OF PART NUMBERS

RF	15	N	100	G	500	C	T
<b>Series</b> RF=Microwave	<b>Size (Inch (mm))</b> 15=0402 (1005)	<b>Dielectric</b> N=NPO	<b>Capacitance</b> 100=10x10 <sup>0</sup> =10pF	<b>Tolerance</b> G=±2%	<b>Rated voltage</b> 500=50 VDC	<b>Termination</b> C=Cu/Ni/Sn	<b>Packaging</b> T=7" reeled

\* Please refer to page 2 "How to order" for more information.

### ■ ELECTRICAL CHARACTERISTICS

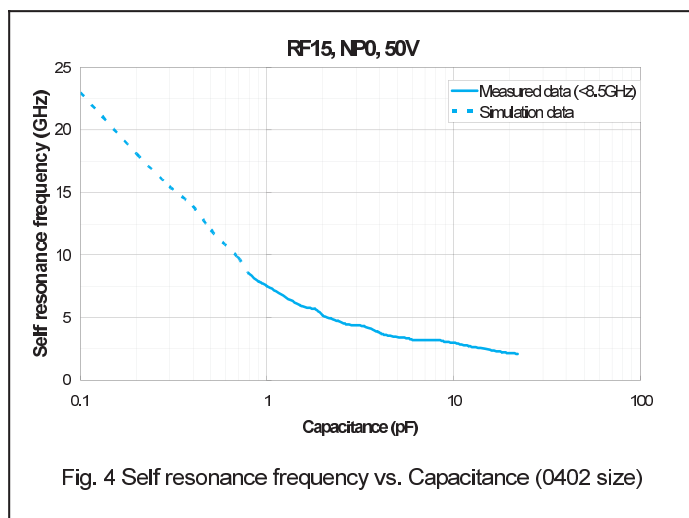
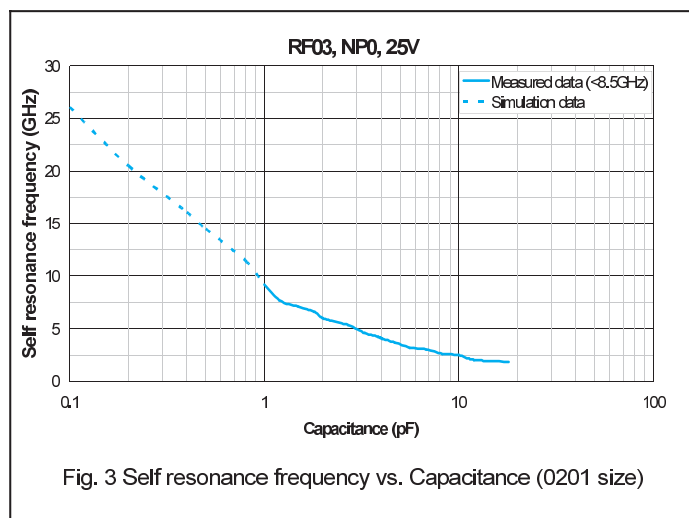

## ■ CAPACITANCE RANGE

DIELECTRIC		NPO													
SIZE		0201				0402			0603			0805			
RATED VOLTAGE (VDC)		6.3	10	25	50	25	50	100	50	100	250	50	100	250	500
Capacitance	0.1pF (0R1)	L	L	L	L	N	N	N							
	0.2pF (0R2)	L	L	L	L	N	N	N							
	0.3pF (0R3)	L	L	L	L	N	N	N	S	S	S	T	T	T	T
	0.4pF (0R4)	L	L	L	L	N	N	N	S	S	S	T	T	T	T
	0.5pF (0R5)	L	L	L	L	N	N	N	S	S	S	T	T	T	T
	0.6pF (0R6)	L	L	L	L	N	N	N	S	S	S	T	T	T	T
	0.7pF (0R7)	L	L	L	L	N	N	N	S	S	S	T	T	T	T
	0.8pF (0R8)	L	L	L	L	N	N	N	S	S	S	T	T	T	T
	0.9pF (0R9)	L	L	L	L	N	N	N	S	S	S	T	T	T	T
	1.0pF (1R0)	L	L	L	L	N	N	N	S	S	S	T	T	T	T
	1.2pF (1R2)	L	L	L	L	N	N	N	S	S	S	T	T	T	T
	1.5pF (1R5)	L	L	L	L	N	N	N	S	S	S	T	T	T	T
	1.8pF (1R8)	L	L	L	L	N	N	N	S	S	S	T	T	T	T
	2.0pF (2R0)	L	L	L	L	N	N	N	S	S	S	T	T	T	T
	2.2pF (2R2)	L	L	L	L	N	N	N	S	S	S	T	T	T	T
	2.7pF (2R7)	L	L	L	L	N	N	N	S	S	S	T	T	T	T
	3.0pF (3R0)	L	L	L	L	N	N	N	S	S	S	T	T	T	T
	3.3pF (3R3)	L	L	L	L	N	N	N	S	S	S	T	T	T	T
	3.9pF (3R9)	L	L	L	L	N	N	N	S	S	S	T	T	T	T
	4.0pF (4R0)	L	L	L	L	N	N	N	S	S	S	T	T	T	T
	4.7pF (4R7)	L	L	L	L	N	N	N	S	S	S	T	T	T	T
	5.0pF (5R0)	L	L	L	L	N	N	N	S	S	S	T	T	T	T
	5.6pF (5R6)	L	L	L	L	N	N	N	S	S	S	T	T	T	T
	6.0pF (6R0)	L	L	L	L	N	N	N	S	S	S	T	T	T	T
	6.8pF (6R8)	L	L	L	L	N	N	N	S	S	S	T	T	T	T
	7.0pF (7R0)	L	L	L	L	N	N	N	S	S	S	T	T	T	T
	8.0pF (8R0)	L	L	L	L	N	N	N	S	S	S	T	T	T	T
	8.2pF (8R2)	L	L	L	L	N	N	N	S	S	S	T	T	T	T
	9.0pF (9R0)	L	L	L	L	N	N	N	S	S	S	T	T	T	T
	10pF (100)	L	L	L	L	N	N	N	S	S	S	T	T	T	T
11pF (110)	L	L	L	L	N	N	N	S	S	S	T	T	T	T	
12pF (120)	L	L	L	L	N	N	N	S	S	S	T	T	T	T	
13pF (130)	L	L	L	L	N	N	N	S	S	S	T	T	T	T	
15pF (150)	L	L	L	L	N	N	N	S	S	S	T	T	T	T	
16pF (160)	L	L	L	L	N	N	N	S	S	S	T	T	T	T	
18pF (180)	L	L	L	L	N	N	N	S	S	S	T	T	T	T	
20pF (200)	L	L	L	L	N	N	N	S	S	S	T	T	T	T	
22pF (220)	L	L	L		N	N	N	S	S	S	T	T	T	T	
24pF (240)	L	L	L		N	N	N	S	S	S	T	T	T	T	
27pF (270)	L	L	L		N	N	N	S	S	S	T	T	T	T	
30pF (300)	L	L	L		N	N	N	S	S	S	T	T	T	T	
33pF (330)	L	L	L		N	N	N	S	S	S	T	T	T	T	
36pF (360)					N	N	N	S	S	S	T	T	T	T	
39pF (390)					N	N	N	S	S	S	T	T	T	T	
43pF (430)					N	N	N	S	S	S	T	T	T	T	
47pF (470)					N	N	N	S	S	S	T	T	T	T	
56pF (560)					N	N	N				T	T	T	T	
68pF (680)					N						T	T	T	T	
82pF (820)					N						T	T	T		
100pF (101)					N						T	T	T		

1. The letter in cell is expressed the symbol of product thickness.

2. For more information about products with special capacitance or other data, please contact WTC local representative.

# Soft Termination Capacitors

## SH/ SG Series

### FEATURES

\* MLCC's terminations build a soft & flexible polymer layer to withstand high bending stress in SMT line.

\* Available for any item in standard series range.

### GENERAL ELECTRICAL DATA

Dielectric	NPO	X7R
Size	0603, 0805, 1206, 1210, 1808, 1812	
Capacitance range	0.5pF to 0.015pF	100pF to 10μF
Capacitance tolerance	Cap≤5pF: B (±0.1pF), C (±0.25pF) 5pF<Cap<10pF: C (±0.25pF), D (±0.5pF) Cap≥10pF: F (±1%), G (±2%), J (±5%), K (±10%)	J (±5%), K (±10%), M (±20%)
Rated voltage (WVDC)	10V, 16V, 25V, 50V, 100V, 200V, 250V, 500V, 630V, 1000V, 2000V, 3000V	
Operating temperature	-55 to +125°C	
Capacitance characteristic	±30ppm	±15%
Termination	Ni/Sn (lead-free termination)	

### EXPLANATION OF PART NUMBERS

SH	31	N	100	D	501	C	T
<b>Series</b> SH=With Ag polymer SG=With Cu polymer	<b>Size (Inch (mm))</b> 31=1206 (3216)	<b>Dielectric</b> N=NPO(C0G)	<b>Capacitance</b> 100=10x10 <sup>0</sup> =10pF	<b>Tolerance</b> D=±0.5pF	<b>Rated voltage</b> 501=50 VDC	<b>Termination</b> C=Cu/Ni/Sn	<b>Packaging</b> T=7" reeled

\* Please refer to page 2 "How to order" for more information.

### PACKAGING DIMENSION AND QUANTITY

Size	L(mm)	W(mm)	Thickness (mm)/Symbol	Paper tape		Plastic tape		
				7" reel	13" reel	7" reel	13" reel	
0603 (1608)	1.60±0.20	0.80±0.10	0.80±0.07	S	4,000	15,000	-	-
	1.60+0.20/-0.10	0.80+0.15/-0.10	0.80+0.15/-0.10	X	4,000	15,000	-	-
0805 (2012)	2.00±0.20	1.25±0.10	0.60±0.10	A	4,000	15,000	-	-
			0.80±0.10	B	4,000	15,000	-	-
	1.25±0.10	D	-	-	3,000	10,000	-	-
	2.00+0.25/-0.2	1.25±0.20	1.25±0.20	I	-	-	3,000	10,000
1206 (3216)	3.20+0.4/-0.1	1.60±0.15	0.80±0.10	B	4,000	15,000	-	-
			0.95±0.10	C	-	-	3,000	10,000
			1.15±0.15	J	-	-	3,000	10,000
			1.25±0.10	D	-	-	3,000	10,000
	3.20+0.4/-0.1	1.60±0.20	1.60±0.20	G	-	-	2,000	10,000
	3.20+0.4/-0.1	1.60+0.30/-0.10	1.60+0.30/-0.10	P	-	-	2,000	9,000
1210 (3225)	3.20±0.40	2.50±0.20	0.95±0.10	C	-	-	3,000	10,000
			1.25±0.10	D	-	-	3,000	10,000
	3.20±0.50	2.50±0.30	1.60±0.20	G	-	-	2,000	10,000
			2.00±0.20	K	-	-	1,000	6,000
			2.50±0.30	M	-	-	1,000	6,000
1808 (4520)	4.50+0.60/-0.4	2.03±0.25	1.25±0.10	D	-	-	2,000	-
			2.00±0.20	K	-	-	1,000	-
1812 (4532)	4.50+0.60/-0.4	3.20±0.30	1.25±0.10	D	-	-	1,000	-
			2.00±0.20	K	-	-	1,000	-
		3.20±0.40	2.50±0.30	M	-	-	500	3,000

Unit: pieces

## ■ CAPACITANCE RANGE(SH Series) NP0 Dielectric

DIELECTRIC		NP0																	
		0402		0603		0805			1206			1210				1808			
SIZE		10, 16, 25, 50	100	10, 16, 25, 50	200, 250	10, 16, 25, 50, 100	200, 250	500, 600	10 to 630	1000	2000	10, 16, 25, 50, 100	200, 250	500, 600	1000	2000	500, 630, 1000, 2000	3000	
RATED VOLTAGE (VDC)																			
Capacitance	0.5pF (0R5)	E	E	S	S	A	A	A											
	1.0pF (1R0)	E	E	S	S	A	A	A											
	1.2pF (1R2)	E	E	S	S	A	A	A											
	1.5pF (1R5)	E	E	S	S	A	A	A	B	B	B								
	1.8pF (1R8)	E	E	S	S	A	A	A	B	B	B								
	2.2pF (2R2)	E	E	S	S	A	A	A	B	B	B							D	
	2.7pF (2R7)	E	E	S	S	A	A	A	B	B	B							D	
	3.3pF (3R3)	E	E	S	S	A	A	A	B	B	B							D	
	3.9pF (3R9)	E	E	S	S	A	A	A	B	B	B							D	
	4.7pF (4R7)	E	E	S	S	A	A	A	B	B	B							D	
	5.6pF (5R6)	E	E	S	S	A	A	A	B	B	B							D	D
	6.8pF (6R8)	E	E	S	S	A	A	A	B	B	B							D	D
	8.2pF (8R2)	E	E	S	S	A	A	A	B	B	B							D	D
	10pF (100)	E	E	S	S	A	A	A	B	B	B	C	C	C	C	C	C	D	D
	12pF (120)	E	E	S	S	A	A	A	B	B	B	C	C	C	C	C	C	D	D
	15pF (150)	E	E	S	S	A	A	A	B	B	B	C	C	C	C	C	C	D	D
	18pF (180)	E	E	S	S	A	A	A	B	B	B	C	C	C	C	C	C	D	D
	22pF (220)	E	E	S	S	A	A	A	B	B	B	C	C	C	C	C	C	D	D
	27pF (270)	E	E	S	S	A	A	A	B	B	B	C	C	C	C	C	C	D	D
	33pF (330)	E	E	S	S	A	A	A	B	B	C	C	C	C	C	C	C	D	D
	39pF (390)	E	E	S	S	A	A	A	B	B	C	C	C	C	C	C	C	D	D
	47pF (470)	E	E	S	S	A	A	A	B	C	C	C	C	C	C	C	C	D	D
	56pF (560)	E	E	S	S	A	A	A	B	C	D	C	C	C	C	C	D	D	D
	68pF (680)	E	E	S	S	A	A	A	B	C	D	C	C	C	C	C	D	D	D
	82pF (820)	E	E	S	S	A	A	B	B	D	D	C	C	C	C	D	D	D	D
	100pF (101)	E	E	S	S	A	A	B	B	D	D	C	C	C	D	D	D	D	K
	120pF (121)	E	E	S	S	A	A	D	B	D	G	C	C	C	D	D			
	150pF (151)	E	E	S	S	A	B	D	B	D	G	C	C	C	D	G			
	180pF (181)	E	E	S	S	A	B	D	B	G	G	C	C	C	D	G			
	220pF (221)	E	E	S	S	A	D	D	B	G	G	C	C	C	G	G			
	270pF (271)	E		S	X	A	D	D				C	C	C	G				
	330pF (331)	E		S	X	A	D	D				C	C	C	G				
	390pF (391)	E		S	X	B	D	D				C	C	C	G				
	470pF (471)	E		S	X	B	D					C	C	C	G				
	560pF (561)	E		S		B	D					C	C	C					
680pF (681)	E		S		B	D					C	C	C						
820pF (821)	E		S		B	D					C	C	C						
1,000pF (102)	E		S		B	D					C	D	D						
1,200pF (122)											C	D	D						
1,500pF (152)											C	D	D						
1,800pF (182)											C	D	D						
2,200pF (222)											C	D							
2,700pF (272)											C	D							
3,300pF (332)											C	D							
3,900pF (392)											C	D							
4,700pF (472)											C								
5,600pF (562)											C								
6,800pF (682)											C								
8,200pF (822)											C								
0.010μF (103)											C								
0.012μF (123)											D								
0.015μF (153)											D								

1. The letter in cell is expressed the symbol of product thickness.  
 2. For more information about products with special capacitance or other data, please contact WTC local representative.

# Soft Termination Capacitors SH / SG Series

## ■ CAPACITANCE RANGE (SH Series)

### X7R Dielectric 10V To 250V

DIELECTRIC		X7R																									
		SIZE				0603				0805				1206				1210				1812					
		10 16	25	50		10 16	25	50	100	200 250	10 16 25	50	100	200 250	10 16	25	50	100	200 250	10 16 25	50	100	200 250	10 16 25	50	100	200 250
Capacitance	100pF (101)	E	E	E	S	S	S	S	X	D	D	D															
	120pF (121)	E	E	E	S	S	S	S	X	D	D	D	D														
	150pF (151)	E	E	E	S	S	S	S	X	D	D	D	D	D	D	D	D	D									
	180pF (181)	E	E	E	S	S	S	S	X	D	D	D	D	D	D	D	D	D									
	220pF (221)	E	E	E	S	S	S	S	X	D	D	D	D	D	D	D	D	D									
	270pF (271)	E	E	E	S	S	S	S	X	D	D	D	D	D	D	D	D	D									
	330pF (331)	E	E	E	S	S	S	S	X	D	D	D	D	D	D	D	D	D									
	390pF (391)	E	E	E	S	S	S	S	X	D	D	D	D	D	D	D	D	D									
	470pF (471)	E	E	E	S	S	S	S	X	D	D	D	D	D	D	D	D	D									
	560pF (561)	E	E	E	S	S	S	S	X	D	D	D	D	D	D	D	D	D									
	680pF (681)	E	E	E	S	S	S	S	X	D	D	D	D	D	D	D	D	D									
	820pF (821)	E	E	E	S	S	S	S	X	D	D	D	D	D	D	D	D	D									
	1,000pF (102)	E	E	E	S	S	S	S	X	D	D	D	D	D	D	D	D	D	C	C	C	C	D	D	D	D	D
	1,200pF (122)	E	E	E	S	S	S	S	X	D	D	D	D	D	D	D	D	D	C	C	C	C	D	D	D	D	D
	1,500pF (152)	E	E	E	S	S	S	S	X	D	D	D	D	D	D	D	D	D	C	C	C	C	D	D	D	D	D
	1,800pF (182)	E	E	E	S	S	S	S	X	D	D	D	D	D	D	D	D	D	C	C	C	C	D	D	D	D	D
	2,200pF (222)	E	E	E	S	S	S	S	X	D	D	D	D	D	D	D	D	D	C	C	C	C	D	D	D	D	D
	2,700pF (272)	E	E	E	S	S	S	S		D	D	D	D	D	D	D	D	D	C	C	C	C	D	D	D	D	D
	3,300pF (332)	E	E	E	S	S	S	S		D	D	D	D	D	D	D	D	D	C	C	C	C	D	D	D	D	D
	3,900pF (392)	E	E	E	S	S	S	S		D	D	D	D	D	D	D	D	D	C	C	C	C	D	D	D	D	D
	4,700pF (472)	E	E	E	S	S	S	S		D	D	D	D	D	D	D	D	D	C	C	C	C	D	D	D	D	D
	5,600pF (562)	E	E	E	S	S	S	S		D	D	D	D	D	D	D	D	D	C	C	C	C	D	D	D	D	D
	6,800pF (682)	E	E	E	S	S	S	S		D	D	D	D	D	D	D	D	D	C	C	C	C	D	D	D	D	D
	8,200pF (822)	E	E	E	S	S	S	S		D	D	D	D	D	D	D	D	D	C	C	C	C	D	D	D	D	D
	0.010μF (103)	E	E	E	S	S	S	S		D	D	D	D	D	D	D	D	D	C	C	C	C	D	D	D	D	D
	0.012μF (123)	E	E		S	S	S			D	D	D	D	D	D	D	D	D	C	C	C	C	D	D	D	D	D
	0.015μF (153)	E	E		S	S	S			D	D	D	D	D	D	D	D	D	C	C	C	C	D	D	D	D	D
	0.018μF (183)	E	E		S	S	S			D	D	D	D	D	D	D	D	D	C	C	C	C	D	D	D	D	D
	0.022μF (223)	E	E		S	S	S			D	D	D	D	D	D	D	D	D	C	C	C	C	D	D	D	D	D
	0.027μF (273)	E	E		S	S	S			D	D	D		D	D	D	D	D	C	C	C	C	D	D	D	D	D
	0.033μF (333)	E	E		S	S	X			D	D	D		D	D	D	D	G	C	C	C	C	D	D	D	D	D
	0.039μF (393)	E	E		S	S	X			D	D	D		D	D	D	D	G	C	C	C	C	D	D	D	D	D
	0.047μF (473)	E	E		S	S	X			D	D	D		D	D	D	D	G	C	C	C	D	D	D	D	D	D
	0.056μF (563)	E			S	S	X			D	D	D		D	D	D	D	G	C	C	C	D	D	D	D	D	D
0.068μF (683)	E			S	S	X			D	D	D		D	D	D	D	G	C	C	C	G	D	D	D	D	D	
0.082μF (823)	E			S	S	X			D	D	D		D	D	D	D	G	C	C	C	G	D	D	D	D	D	
0.10μF (104)	E			S	S	X			D	D	D		D	D	D	D	G	C	C	C	G	D	D	D	D	D	
0.12μF (124)				S	X				D	D			D	D	D	D		C	C	C	G	D	D	D	D	D	
0.15μF (154)				S	X				D	D			C	C	C	G		C	C	D	M	D	D	D	D	K	
0.18μF (184)				S	X				D	D			C	C	C	G		C	C	D	M	D	D	D	D	K	
0.22μF (224)				S	X				D	D			C	C	C	G		C	C	D	M	D	D	D	D	K	
0.27μF (274)				X	X				I				C	C	D			C	C	G	M	D	D	D	D	K	
0.33μF (334)				X	X				I				C	C	D			C	C	G	M	D	D	D	D	K	
0.39μF (394)				X	X				I				J	J	P			C	C	M	M	D	D	D	D	K	
0.47μF (474)				X	X				I				J	J	P			C	C	M	M	D	D	K	K	K	
0.56μF (564)				X					I				J	J	P			D	D	M		D	D	K	M	M	
0.68μF (684)				X					I				J	J	P			D	D	K		D	K	K	M	M	
0.82μF (824)									I				J	J	P			D	D	K		D	K	K	M	M	
1.0μF (105)									I				J	J	P			D	D	K		D	K	K	M	M	
1.5μF (155)													J	P											K		
2.2μF (225)													J	P											M		
3.3μF (335)													P	P							G						
4.7μF (475)													P	P							G						
10μF (106)													P	P							K						

- The letter in cell is expressed the symbol of product thickness.
- For more information about products with special capacitance or other data, please contact WTC local representative

## ■ CAPACITANCE RANGE (SH Series)

X7R Dielectric 500V To 3kV

DIELECTRIC		X7R																
		0805		1206				1210			1808			1812				
SIZE		500	630	500	630	1000	2000	500	630	1000	500	630	1000	500	630	1000	2000	3000
RATED VOLTAGE (VDC)		500	630	500	630	1000	2000	500	630	1000	500	630	1000	500	630	1000	2000	3000
Capacitance	100pF (101)	B	B															
	120pF (121)	B	B															
	150pF (151)	B	B	D	D	D	D				D	D	D					
	180pF (181)	B	B	D	D	D	D				D	D	D					
	220pF (221)	B	B	D	D	D	D				D	D	D					
	270pF (271)	B	B	D	D	D	D				D	D	D		D	D		
	330pF (331)	B	B	D	D	D	D				D	D	K		D	D		
	390pF (391)	B	B	D	D	D	D				D	D	K		D	D		
	470pF (471)	B	B	D	D	D	D				D	D	K		D	D	K	
	560pF (561)	B	B	D	D	D	D				D	D	K		D	D	K	
	680pF (681)	B	B	D	D	D	D				D	D	K		D	D	K	
	820pF (821)	B	B	D	D	D	G				D	D	K		D	D	K	
	1,000pF (102)	B	B	D	D	D	G	D	D	D	D	D	K	D	D	D	K	
	1,200pF (122)	B	B	D	D	D		D	D	D	D	K		D	D	D		
	1,500pF (152)	B	B	D	D	D		D	D	D	D	K		D	D	D		
	1,800pF (182)	B	B	D	D	D		D	D	D	D	K		D	D	D		
	2,200pF (222)	B	B	D	D	D		D	D	D	D	K		D	D	D		
	2,700pF (272)	B	B	D	D	D		D	D	D	D			D	D	D		
	3,300pF (332)	B	B	D	D	D		D	D	D	D			D	D	K		
	3,900pF (392)	B	B	D	D	D		D	D	G	D			D	D	K		
	4,700pF (472)	D	D	D	D	D		D	D	G	D			D	D	K		
	5,600pF (562)	D	D	D	D	D		D	D	G	K			D	D			
	6,800pF (682)	D	D	D	D	D		D	D	G	K			D	D			
	8,200pF (822)	D	D	D	D	D		D	D	G	K			D	D			
	0.010μF (103)	D	D	D	D	D		D	D	G	K			D	D			
	0.012μF (123)			D	D			D	D					D	K			
	0.015μF (153)			D	D			D	D					D	K			
	0.018μF (183)			D	D			D	D					D				
	0.022μF (223)			G	G			D	D					D				
	0.027μF (273)			G	G			G	G					D				
	0.033μF (333)			G	G			G	G					D				
	0.039μF (393)							G	G					D				
	0.047μF (473)							G	G					D				
	0.056μF (563)							G	G					K				
	0.068μF (683)													K				
0.082μF (823)													K					
0.10μF (104)													K					
0.12μF (124)																		
0.15μF (154)																		
0.18μF (184)																		
0.22μF (224)																		
0.27μF (274)																		
0.33μF (334)																		
0.39μF (394)																		
0.47μF (474)																		
0.56μF (564)																		
0.68μF (684)																		
0.82μF (824)																		
1.00μF (105)																		

1. The letter in cell is expressed the symbol of product thickness.
2. For more information about products with special capacitance or other data, please contact WTC local representative

# Soft Termination Capacitors

## SH / SG Series

### ■ CAPACITANCE RANGE (SG Series) NP0 Dielectric

DIELECTRIC		NP0							
SIZE		0603				0805			
RATED VOLTAGE (VDC)		10	16	25	50	10	16	25	50
Capacitance	0.1pF (0R1)								
	0.2pF (0R2)								
	0.3pF (0R3)								
	0.4pF (0R4)								
	0.5pF (0R5)	S	S	S	S	A	A	A	A
	0.6pF (0R6)	S	S	S	S	A	A	A	A
	0.7pF (0R7)	S	S	S	S	A	A	A	A
	0.8pF (0R8)	S	S	S	S	A	A	A	A
	0.9pF (0R9)	S	S	S	S	A	A	A	A
	1.0pF (1R0)	S	S	S	S	A	A	A	A
	1.2pF (1R2)	S	S	S	S	A	A	A	A
	1.5pF (1R5)	S	S	S	S	A	A	A	A
	1.8pF (1R8)	S	S	S	S	A	A	A	A
	2.2pF (2R2)	S	S	S	S	A	A	A	A
	2.7pF (2R7)	S	S	S	S	A	A	A	A
	3.3pF (3R3)	S	S	S	S	A	A	A	A
	3.9pF (3R9)	S	S	S	S	A	A	A	A
	4.7pF (4R7)	S	S	S	S	A	A	A	A
	5.6pF (5R6)	S	S	S	S	A	A	A	A
	6.8pF (6R8)	S	S	S	S	A	A	A	A
	8.2pF (8R2)	S	S	S	S	A	A	A	A
	10pF (100)	S	S	S	S	A	A	A	A
	12pF (120)	S	S	S	S	A	A	A	A
	15pF (150)	S	S	S	S	A	A	A	A
	18pF (180)	S	S	S	S	A	A	A	A
	22pF (220)	S	S	S	S	A	A	A	A
	27pF (270)	S	S	S	S	A	A	A	A
	33pF (330)	S	S	S	S	A	A	A	A
	39pF (390)	S	S	S	S	A	A	A	A
	47pF (470)	S	S	S	S	A	A	A	A
	56pF (560)	S	S	S	S	A	A	A	A
	68pF (680)	S	S	S	S	A	A	A	A
	82pF (820)	S	S	S	S	A	A	A	A
	100pF (101)	S	S	S	S	A	A	A	A
	120pF (121)	S	S	S	S	A	A	A	A
	150pF (151)	S	S	S	S	A	A	A	A
	180pF (181)	S	S	S	S	A	A	A	A
	220pF (221)	S	S	S	S	A	A	A	A
	270pF (271)	S	S	S	S	A	A	A	A
	330pF (331)	S	S	S	S	A	A	A	A
	390pF (391)	S	S	S	S	B	B	B	B
	470pF (471)	S	S	S	S	B	B	B	B
560pF (561)	S	S	S	S	B	B	B	B	
680pF (681)	S	S	S	S	B	B	B	B	
820pF (821)	S	S	S	S	B	B	B	B	
1,000pF (102)	S	S	S	S	B	B	B	B	
1,200pF (122)	X	X	X	X	B	B	B	B	
1,500pF (152)	X	X	X	X	B	B	B	B	
1,800pF (182)	X	X	X	X	B	B	B	B	
2,200pF (222)	X	X	X	X	B	B	B	B	
2,700pF (272)					D	D	D	D	
3,300pF (332)					D	D	D	D	
3,900pF (392)					D	D	D	D	
4,700pF (472)					D	D	D	D	
5,600pF (562)					D	D	D	D	
6,800pF (682)					D	D	D	D	
8,200pF (822)					D	D	D	D	
0.010uF (103)					D	D	D	D	
0.012uF (123)									

1. The letter in cell is expressed the symbol of product thickness.

2. For more information about products with special capacitance or other data, please contact WTC local representative.



## ■ CAPACITANCE RANGE (SG Series)

### X7R Dielectric

DIELECTRIC		X7R			
SIZE		0603			
RATED VOLTAGE (VDC)		10	16	25	50
Capacitance	100pF (101)	S	S	S	S
	120pF (121)	S	S	S	S
	150pF (151)	S	S	S	S
	180pF (181)	S	S	S	S
	220pF (221)	S	S	S	S
	270pF (271)	S	S	S	S
	330pF (331)	S	S	S	S
	390pF (391)	S	S	S	S
	470pF (471)	S	S	S	S
	560pF (561)	S	S	S	S
	680pF (681)	S	S	S	S
	820pF (821)	S	S	S	S
	1,000pF (102)	S	S	S	S
	1,200pF (122)	S	S	S	S
	1,500pF (152)	S	S	S	S
	1,800pF (182)	S	S	S	S
	2,200pF (222)	S	S	S	S
	2,700pF (272)	S	S	S	S
	3,300pF (332)	S	S	S	S
	3,900pF (392)	S	S	S	S
	4,700pF (472)	S	S	S	S
	5,600pF (562)	S	S	S	S
	6,800pF (682)	S	S	S	S
	8,200pF (822)	S	S	S	S
	0.010μF (103)	S	S	S	S
	0.012μF (123)	S	S	S	S
	0.015μF (153)	S	S	S	S
	0.018μF (183)	S	S	S	S
	0.022μF (223)	S	S	S	S
	0.027μF (273)	S	S	S	S
	0.033μF (333)	S	S	S	X
	0.039μF (393)	S	S	S	X
	0.047μF (473)	S	S	S	X
	0.056μF (563)	S	S	S	X
	0.068μF (683)	S	S	S	X
	0.082μF (823)	S	S	S	X
	0.10μF (104)	S	S	S	X
	0.12μF (124)				
	0.15μF (154)				
	0.18μF (184)				
0.22μF (224)					
0.27μF (274)					
0.33μF (334)					
0.39μF (394)					
0.47μF (474)					
0.56μF (564)					
0.68μF (684)					
0.82μF (824)					
1.0μF (105)					

### Y5V Dielectric

DIELECTRIC		Y5V	
SIZE		0603	
RATED VOLTAGE (VDC)		10	16
Capacitance	0.010μF (103)	S	S
	0.015μF (153)	S	S
	0.022μF (223)	S	S
	0.033μF (333)	S	S
	0.047μF (473)	S	S
	0.068μF (683)	S	S
	0.10μF (104)	S	S
	0.15μF (154)	S	S
	0.22μF (224)	S	S
	0.33μF (334)	S	S
	0.47μF (474)	S	S
	0.68μF (684)	S	X
	1.0μF (105)	S	X

1. The letter in cell is expressed the symbol of product thickness.
2. For more information about products with special capacitance or other data, please contact WTC local representative.

### ■ FEATURES

- \* High voltage in a given case size.
- \* Circuit open during product cracking.
- \* High stability and reliability.

### ■ GENERAL ELECTRICAL DATA

Dielectric	X7R
Size	0805, 1206, 1210, 1812
Capacitance	100pF to 1 $\mu$ F
Capacitance tolerance	K ( $\pm 10\%$ ), M ( $\pm 20\%$ )
Rated voltage (WVDC)	100V, 200V, 250V, 500V
DF(Tan $\delta$ )	$\leq 2.5\%$
Insulation resistance at Ur	$\geq 10G\Omega$ or $RxC \geq 500\Omega \cdot F$ whichever is smaller
Dielectric strength	100V: $\geq 2.5 \times$ WVDC 200V and 250V: $\geq 2 \times$ WVDC 500V: $\geq 1.5 \times$ WVDC
Operating temperature	-55 to +125 $^{\circ}$ C
Capacitance characteristic	$\pm 15\%$
Termination	Ni/Sn (lead-free termination)

### ■ EXPLANATION OF PART NUMBERS

OP	32	B	103	K	201	C	T
<b>Series</b>	<b>Size (Inch (mm))</b>	<b>Dielectric</b>	<b>Capacitance</b>	<b>Tolerance</b>	<b>Rated voltage</b>	<b>Termination</b>	<b>Packaging</b>
OP=Open-mode	32=1210 (3225)	B=X7R	103=10x10 <sup>3</sup> =10nF	K= $\pm 10\%$	201=200 VDC	C=Cu/Ni/Sn	T=7" reeled

\* Please refer to page 2 "How to order" for more information.

### ■ INNER CONSTRUCTION OF OPEN-MODE DESIGN

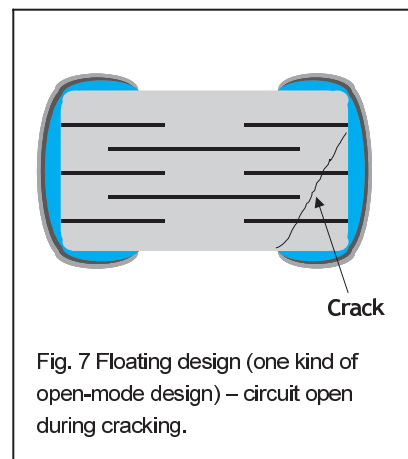
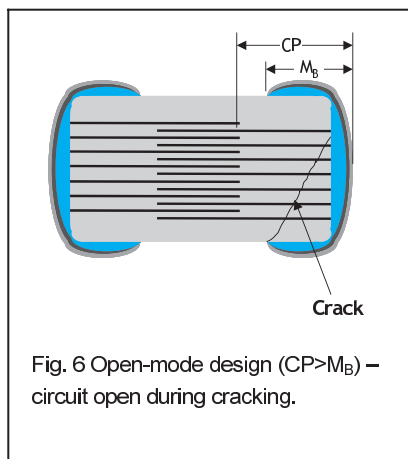
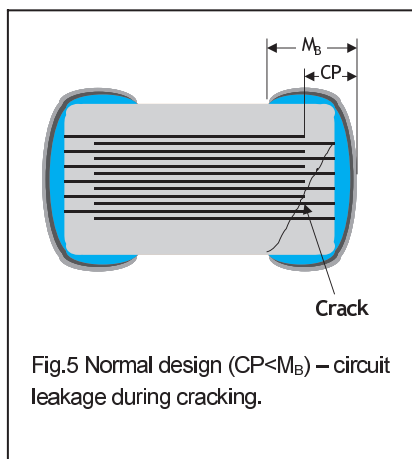

## ■ CAPACITANCE RANGE

DIELECTRIC		X7R															
		0805				1206				1210				1812			
SIZE		100	200	250	500	100	200	250	500	100	200	250	500	100	200	250	500
RATED VOLTAGE (VDC)		100	200	250	500	100	200	250	500	100	200	250	500	100	200	250	500
Capacitance	100pF (101)	B	B	B	B												
	120pF (121)	B	B	B	B												
	150pF (151)	B	B	B	B	B	D	D	D								
	180pF (181)	B	B	B	B	B	D	D	D								
	220pF (221)	B	B	B	B	B	D	D	D								
	270pF (271)	B	B	B	B	B	D	D	D								
	330pF (331)	B	B	B	B	B	D	D	D								
	390pF (391)	B	B	B	B	B	D	D	D								
	470pF (471)	B	B	B	B	B	D	D	D								
	560pF (561)	B	B	B	B	B	D	D	D								
	680pF (681)	B	B	B	B	B	D	D	D								
	820pF (821)	B	B	B	B	B	D	D	D								
	1,000pF (102)	B	B	B	B	B	D	D	D	C	C	C	D	D	D	D	D
	1,200pF (122)	B	B	B	B	B	D	D	D	C	C	C	D	D	D	D	D
	1,500pF (152)	B	B	B	B	B	D	D	D	C	C	C	D	D	D	D	D
	1,800pF (182)	B	B	B	B	B	D	D	D	C	C	C	D	D	D	D	D
	2,200pF (222)	B	B	B	B	B	D	D	D	C	C	C	D	D	D	D	D
	2,700pF (272)	B	B	B	B	B	D	D	D	C	C	C	D	D	D	D	D
	3,300pF (332)	B	B	B	B	B	D	D	D	C	C	C	D	D	D	D	D
	3,900pF (392)	B	B	B	B	B	D	D	D	C	C	C	D	D	D	D	D
	4,700pF (472)	B	B	B	D	B	D	D	D	C	C	C	D	D	D	D	D
	5,600pF (562)	B	D	D	D	B	D	D	D	C	C	C	D	D	D	D	D
	6,800pF (682)	B	D	D	D	B	D	D	D	C	C	C	D	D	D	D	D
	8,200pF (822)	B	D	D	D	B	D	D	D	C	C	C	D	D	D	D	D
	0.010μF (103)	B	D	D	D	B	D	D	D	C	C	C	D	D	D	D	D
	0.012μF (123)	B	D	D		B	D	D	D	C	C	C	D	D	D	D	D
	0.015μF (153)	B	D	D		B	D	D	D	C	C	C	D	D	D	D	D
	0.018μF (183)	B	D	D		B	D	D	D	C	C	C	D	D	D	D	D
	0.022μF (223)	B	D	D		B	D	D	G	C	C	C	D	D	D	D	D
	0.027μF (273)	D				B	D	D	G	C	C	C	D	D	D	D	D
	0.033μF (333)	D				B	G	G	G	C	C	C	G	D	D	D	D
	0.039μF (393)	D				B	G	G		C	C	C	G	D	D	D	D
	0.047μF (473)	D				B	G	G		C	D	D	G	D	D	D	D
0.056μF (563)					B	G	G		C	D	D	G	D	D	D	K	
0.068μF (683)					B	G	G		C	G	G	G	D	D	D	K	
0.082μF (823)					D	G	G		C	G	G		D	D	D	K	
0.10μF (104)					D	G	G		C	G	G		D	D	D	K	
0.12μF (124)					D				C	G	G		D	D	D		
0.15μF (154)					G				D	M	M		D	K	K		
0.18μF (184)					G				D	M	M		D	K	K		
0.22μF (224)					G				D	M	M		D	K	K		
0.27μF (274)									G				D	K	K		
0.33μF (334)									G				D	K	K		
0.39μF (394)									M				D	K	K		
0.47μF (474)									M				K	K	K		
0.56μF (564)									M				K				
0.68μF (684)													K				
0.82μF (824)													K				
1.0μF (105)													K				

1. The letter in cell is expressed the symbol of product thickness.

2. For more information about products with special capacitance or other data, please contact WTC local representative.

# Capacitor Array Capacitors

## Y4C3/Y4C2 Series

### ■ FEATURES

- \* High density mounting due to mounting space saving.
- \* Mounting cost saving.
- \* Increased throughput.

### ■ GENERAL ELECTRICAL DATA

Dielectric	NP0		X7R		Y5V
Size	4x0402	4x0603	4x0402	4x0603	4x0603
Capacitance*	10pF to 270pF	10pF to 470pF	1000pF to 100nF	180pF to 100nF	10nF to 100nF
Capacitance tolerance**	J (±5%), K (±10%)		K (±10%), M (±20%)		Z (-20/+80%)
Rated voltage (WVDC)	25,50V,100V	25, 50V,100V	10V, 16V, 25V, 50V	16V, 25V, 50V	16V, 50V
Q/DF(Tan δ)*	Cap<30pF: Q≥400+20C Cap≥30pF: Q≥1000		Ur=50V, ≤2.5% Ur=25V&16V, ≤3.5% Ur=10V, ≤5.0%		Ur=50V, ≤5% Ur=16V, ≤7%
Insulation resistance at Ur	≥10GΩ		≥10GΩ or RxC≥500ΩxF whichever is less		
Operating temperature	-55 to +125°C				-25 to +85°C
Capacitance characteristic	±30ppm		±15%		+30/-80%
Termination	Ni/Sn (lead-free termination)				

### ■ EXPLANATION OF PART NUMBERS

Y	4C	3	B	103	K	500	C	T
<b>Series</b>	<b>Cap. Nr.</b>	<b>Termination pitch</b>	<b>Dielectric</b>	<b>Capacitance</b>	<b>Tolerance</b>	<b>Rated voltage</b>	<b>Termination</b>	<b>Packaging</b>
Y=Capacitor array	4C=4xCap	3=0.03" pitch 2=0.02" pitch	B=X7R	103=10x10 <sup>3</sup> =10nF	K=±10%	500=50 VDC	C=Cu/Ni/Sn	T=7" reeled

\* Please refer to page 2 "How to order" for more information.

### ■ CAPACITANCE RANGE

SIZE	4 x 0402					4 x 0603					
	DIELECTRIC	NP0	X7R			NP0	X7R			Y5V	
RATED VOLTAGE (VDC)	25,50,100	10	16	25	50	25,50,100	16	25	50	16	50
Capacitance	10pF (100)	T				B					
	15pF (150)	T				B					
	22pF (220)	T				B					
	33pF (330)	T				B					
	47pF (470)	T				B					
	68pF (680)	T				B					
	100pF (101)	T				B					
	150pF (151)	T				B					
	180pF (181)	T				B		B	B		
	220pF (221)	T				B		B	B		
	270pF (271)	T				B		B	B		
	330pF (331)					B		B	B		
	470pF (471)					B		B	B		
	6,80pF (681)							B	B		
	1,000pF (102)		T	T	T	T		B	B		
	1,500pF (152)		T	T	T	T		B	B		
	2,200pF (222)		T	T	T	T		B	B		
	3,300pF (332)		T	T	T	T		B	B		
	4,700pF (472)		T	T	T	T		B	B		
	6,800pF (682)		T	T	T	T		B	B		
0.010μF (103)		T	T	T	T		B	B		B	
0.015μF (153)		T	T	T			B	B	B	B	
0.022μF (223)		T	T	T			B	B	B	B	
0.033μF (333)		T	T	T			B			B	
0.047μF (473)		T	T	T			B			B	
0.068μF (683)		T	T	T			B			B	
0.10μF (104)		T	T	T			B			B	

1. The letter in cell is expressed the symbol of product thickness.

2. For more information about products with special capacitance or other data, please contact WTC local representative.

## FEATURES

- \* Standard size with thin thickness.
- \* Small size with high capacitance.
- \* Capacitor with lead-free termination (pure Tin).

## GENERAL ELECTRICAL DATA

Dielectric	X7R	X5R	Y5V
Size	0402, 0603, 0805, 1206, 1210		
Capacitance range	0.22μF to 4.7μF	0.22μF to 22μF	1μF to 10μF
Capacitance tolerance	K (±10%), M (±20%)		Z (-20/+80%)
Rated voltage (WVDC)	6.3V, 10V, 16V, 25V	6.3V, 10V, 16V, 25V, 50V	10V, 16V, 25V, 50V
DF(Tan δ)*	16V, 10V: ≤10.0% 6.3V: ≤15.0%		50V: ≤7% 25V: ≤9% 16V, 10V: ≤12.5%
Insulation resistance at Ur	RxC≥100ΩxF		
Operating temperature	-55 to +125°C	-55 to +85°C	-25 to +85°C
Capacitance characteristic	±15%		+30/-80%
Termination	Ni/Sn (lead-free termination)		

## EXPLANATION OF PART NUMBERS

TT	31	X	225	K	100	C	T
Series	Size (Inch (mm))	Dielectric	Capacitance	Tolerance	Rated voltage	Termination	Packaging
TT=Low profile	31=1206 (3216)	X=X5R	225=22x10 <sup>5</sup> =2.2μF	K=±10%	100=10 VDC	C=Cu/Ni/Sn	T=7" reeled

\* Please refer to page 2 "How to order" for more information.

## CAPACITANCE RANGE

Dielectric	X5R																	
	0402		0603		0805				1206				1210					
Size	6.3,10		25	10	16	6.3	10	16	25	6.3	10	16	25	50	10	16	25	
Rated voltage (VDC)	6.3,10		25	10	16	6.3	10	16	25	6.3	10	16	25	50	10	16	25	
Capacitance	0.22μF (224)		L	H	H													
	0.47μF (474)		L															
	1.0μF (105)		L		H	H		T	T	T		T	T	T				
	1.5μF (155)							T	T			T	T	T				
	2.2μF (225)						T	T	T	T		T	T	T	T			
	3.3μF (335)											T	T	T		T		
	4.7μF (475)				H		T	T	T	T		T	T	T		T		
	6.8μF (685)																	
	10μF (106)						T	T			J	T	T	T		T		T
	22μF (226)						T				T						T	
47μF (476)										T								

Dielectric	X7R						Y5V								
	0805			1206			0805				1206				1210
Size	10		16, 25	10	25	50	10	16	25	50	10	16	25	50	10
Rated voltage (VDC)	10		16, 25	10	25	50	10	16	25	50	10	16	25	50	10
Capacitance	1.0μF (105)				T						T				
	1.5μF (155)														
	2.2μF (225)			T			T		T			T	T	T	T
	3.3μF (335)							T							
	4.7μF (475)		T			T		T	T			T	T		
	6.8μF (685)											T			
	10μF (106)				T			T				T			T
22μF (226)															

1. The letter in cell is expressed the symbol of product thickness.

2. For more information about products with special capacitance or other data, please contact WTC local representative.

# Low Inductance Capacitors

## 0612 Series

### ■ FEATURES

- \* Standard size with thin thickness.
- \* Small size with high capacitance.
- \* Capacitor with lead-free termination (pure Tin).
- \* MLCC with low ESL performance.

### ■ GENERAL ELECTRICAL DATA

Dielectric	X7R
Size	0612
Capacitance range	10nF to 150nF
Capacitance tolerance	K ( $\pm 10\%$ ), M ( $\pm 20\%$ )
Rated voltage (WVDC)	50V
DF(Tan $\delta$ )*	$\leq 2.5\%$
Insulation resistance at Ur	$\geq 10G\Omega$ or $RxC \geq 500\Omega \times F$ whichever is less
Operating temperature	-55 to +125°C
Capacitance characteristic	$\pm 15\%$
Termination	Ni/Sn (lead-free termination)
ESL	500pH

### ■ EXPLANATION OF PART NUMBERS

0612	B	103	K	500	C	T
<b>Size (Inch (mm))</b>	<b>Dielectric</b>	<b>Capacitance</b>	<b>Tolerance</b>	<b>Rated voltage</b>	<b>Termination</b>	<b>Packaging</b>
0612(1632)	B=X7R	103=10x10 <sup>3</sup> =10nF	K= $\pm 10\%$	500=50 VDC	C=Cu/Ni/Sn	T=7" reeled

\* Please refer to page 2 "How to order" for more information.

### ■ CAPACITANCE RANGE

DIELECTRIC		X7R
SIZE		0612
RATED VOLTAGE (VDC)		50
Capacitance	10nF (103)	B
	12nF (123)	B
	15nF (153)	B
	18nF (183)	B
	22nF (223)	B
	27nF (273)	B
	33nF (333)	B
	39nF (393)	B
	47nF (473)	B
	56nF (563)	B
	68nF (683)	B
	82nF (823)	B
	100nF (104)	B
	120nF (124)	B
150nF (154)	B	

1. The letter in cell is expressed the symbol of product thickness.
2. For more information about products with special capacitance or other data, please contact WTC local representative.

# Safety Certificated Capacitors X1/Y2 S2 Series

## FEATURES

- \* High voltage in a given case size.
- \* High stability and reliability.
- \* RoHS compliant.



## GENERAL ELECTRICAL DATA

Dielectric	NPO	X7R
Size	1808, 1812, 2211	1808, 1812, 2220, 2211
Capacitance	4pF to 680pF	100pF to 4700pF
Capacitance tolerance	J (±5%), K (±10%)	
Rated voltage (WVAC)	250Vrms	
Q/ DF (Tan δ)	Cap<30pF: Q≥400+20C	DF≤2.5%
Insulation resistance at Ur	≥10GΩ	
Dielectric withstanding strength	1500VAC	
Peak impulse voltage	5000V	
Operating temperature	-55 to +125°C	
Capacitance characteristic	±60ppm	±15%
Termination	Ni/Sn (lead-free termination)	
Certified number	TUV: R500021351,R50118359, R50195920,UL: E250427, E182369	
Test standard	EN 60384-14:2005, IEC 60384-14:2005, EN 60384-14:2005, UL 60950:2000, UL 60384-14	

## EXPLANATION OF PART NUMBERS

S2	42	N	100	J	302	L	I
Series S2=X1/Y2	Size (Inch (mm)) 42=1808 (4520)	Dielectric N=NPO	Capacitance 100=10x10 <sup>0</sup> =10pF	Tolerance J=±5%	Rated voltage 302=3000 VDC 602=6000 Impulse Voltage	Termination L=Ag/Ni/Sn C=Cu/Ni/Sn	Packaging T=7" reeled

\* Please refer to page 2 "How to order" for more information.

## CAPACITANCE RANGE

DIELECTRIC	NPO				
	SIZE	1808	1812	2211	
	RATED VOLTAGE (VDC)	3000	3000	3000	
PEAK IMPULSE VOLTAGE	5000	5000	5000	6000	
Capacitance	4pF (4R0)	F		K	K*
	5pF (5R0)	F		K	K*
	10pF (100)	F	D	K	K*
	12pF (120)	F	D	K	K*
	15pF (150)	F	D	K	K*
	18pF (180)	F	D	K	K*
	22pF (220)	F	D	K	K*
	27pF (270)	F	D	K	K*
	33pF (330)	F	D	K	K*
	39pF (390)	G	D	K	K*
	47pF (470)	G	D	K	K*
	56pF (560)	G	D	K	K*
	68pF (680)	G	D	K	M*
	82pF (820)	G	D	K	M*
	100pF (101)	K	D	K	U*
	120pF (121)	K	D	M	
	150pF (151)	K	D	M	
	180pF (181)		D	M	
	220pF (221)		K	M	
	270pF (271)		K	M	
330pF (331)		K	M		
390pF (391)		K	M		
470pF (471)		K	M		
560pF (561)			M		
680pF (681)			M		

DIELECTRIC	X7R				
	SIZE	1808	1812	2211	2220
	RATED VOLTAGE (VDC)	3000			
PEAK IMPULSE VOLTAGE	5000				
Capacitance	56pF (560)				
	68pF (680)				
	82pF (820)				
	100pF (101)	G			
	120pF (121)	G			
	150pF (151)	G	G	G	
	180pF (181)	G	G	G	K
	220pF (221)	G	G	G	K
	270pF (271)	K	G	G	K
	330pF (331)	K	G	G	K
	390pF (391)	K	G	G	K
	470pF (471)	K	G	K	K
	560pF (561)	K	G	K	K
	680pF (681)	K	K	K	K
	820pF (821)	K	K	K	K
	1,000pF (102)	K	M	M	K
	1,200pF (122)			M	M
	1,500pF (152)			M	M
	1,800pF (182)			M	M
	2,200pF (222)			M	M
3,300pF (332)				M	
4,700pF (472)				M	

1. The letter in cell is expressed the symbol of product thickness.
2. The letter in cell with "\*" mark is expressed product with Cu/Ni/Sn terminations.
3. For more information about products with special capacitance or other data, please contact WTC local representative.

## PACKAGING DIMENSION AND QUANTITY ( X1/Y2 & X2/Y3 Series)

Size Inch (mm)	L (mm)	W (mm)	MB min(mm)	T (mm)/Symbol	7" Plastic tape	
1808 (4520)	4.50±0.5/-0.3	2.03±0.25	0.26	1.40±0.15	F	2,000
				1.60±0.20	G	1,000
				2.00±0.20	K	1,000
1812 (4532)	4.50±0.5/-0.3	3.20±0.30	0.26	1.60±0.20	G	1,000
				2.00±0.20	K	1,000
				2.50±0.30	M	500
2220 (5750)	5.70±0.40	5.00±0.40	0.30	2.00±0.20	K	1,000
				2.50±0.30	M	500
				1.60±0.20	G	1,000
2211 (5728)	5.70±0.40	2.80±0.30	0.30	2.00±0.20	K	1,000
				2.50±0.30	M	500

# Safety Certificated Capacitors X2/Y3 S3 Series

## FEATURES

- \* High voltage in a given case size.
- \* High stability and reliability.
- \* RoHS compliant.



## GENERAL ELECTRICAL DATA

Dielectric	NPO	X7R
Size	1808, 1812	
Capacitance*	3.9pF to 1000pF	150pF to 5600pF
Capacitance tolerance	J (±5%), K (±10%)	K (±10%), M (±20%)
Rated voltage (WVDC)	2000V, 3000V	
Rated voltage (WVAC)	250Vrms	
Q/ DF (Tan δ)	Cap<30pF: Q≥400+20C	Tan δ≤2.5%
Insulation resistance at Ur	≥10GΩ	
Dielectric withstanding strength	1500VAC	
Peak impulse voltage (X2)	2500V	
Operating temperature	-55 to +125°C	
Capacitance characteristic	±60ppm	±15%
Termination	Ni/Sn (lead-free termination)	
Certified number	TUV: R500021351, R50118359, R50195920, UL: E250427, E182369	
Test standard	EN 60384-14:2005, IEC 60384-14:2005, UL 60950:2000, UL 60384-14	

## EXPLANATION OF PART NUMBERS

S3	42	N	100	J	202	L	I
Series	Size (Inch (mm))	Dielectric	Capacitance	Tolerance	Rated voltage	Termination	Packaging
S3=X2/Y3	42=1808 (4520)	N=NP0	100=10x10 <sup>0</sup> =10pF	J=±5%	202=2000 VDC	L=Ag/Ni/Sn	T=7" reeled

\* Please refer to page 2 "How to order" for more information.

## CAPACITANCE RANGE

DIELECTRIC	NPO		
	SIZE		
	1808	1812	3000
RATED VOLTAGE (VDC)	2000	3000	3000
3.9pF (3R9)		F	
4.7pF (4R7)		F	
5.0pF (5R0)		F	
5.6pF (5R6)		F	
6.8pF (6R8)		F	
8.2pF (8R2)		F	
10pF (100)	F	F	D
12pF (120)	F	F	D
15pF (150)	F	F	D
18pF (180)	F	F	D
22pF (220)	F	F	D
27pF (270)	F	F	D
33pF (330)	F	F	D
39pF (390)	G	G	D
47pF (470)	G	G	D
56pF (560)	G	G	D
68pF (680)	G	G	D
82pF (820)	G	G	D
100pF (101)	K	K	D
120pF (121)	K	K	D
150pF (151)	K	K	D
180pF (181)	K	K	D
220pF (221)	K	K	D
270pF (271)	K	K	D
330pF (331)	K		D
390pF (391)	K		D
470pF (471)	K		D
560pF (561)	K		D
680pF (681)	K		K
820pF (821)	K		K
1,000pF (102)	K		K

DIELECTRIC	X7R			
	SIZE			
	1808	3000	2000	3000
RATED VOLTAGE (VDC)	2000	3000	2000	3000
150pF (151)	G			
180pF (181)	G			
220pF (221)	G			
270pF (271)	G		G	
330pF (331)	G	G	G	
390pF (391)	G	G	G	
470pF (471)	G	G	G	
560pF (561)	G	G	G	
680pF (681)	G	G	G	G
820pF (821)	G	G	G	G
1,000pF (102)	K	K	G	G
1,200pF (122)	K		G	
1,500pF (152)	K		K	
1,800pF (182)	K		K	
2,200pF (222)	K		M	
2,700pF (272)			M	
3,300pF (332)			M	
3,900pF (392)			M	
4,700pF (472)			M	
5,600pF (562)			M	

1. The letter in cell is expressed the symbol of product thickness.
2. For more information about products with special capacitance or other data, please contact WTC local representative.



# Automotive Capacitors Qualified to AEC-Q200 MT Series

## ■ GENERAL ELECTRICAL DATA

Dielectric	NPO	X7R
Size	0402, 0603, 0805, 1206	
Capacitance range	0.5pF to 0.01uF	100pF to 1uF
Capacitance tolerance	Caps≤5pF:B,C; 5pF<Cap<10pF:C,D; Cap≥10pF:F, G, J	J (±5%), K (±10%), M (±20%)
Rated voltage (WVDC)	10V, 16V, 25V, 50V, 100V	10V, 16V, 25V, 50V, 100V
Operating temperature	-55 to +125°C	
Capacitance characteristic	±30ppm/°C	±15%
Termination	Ni/Sn (lead-free termination)	

## ■ EXPLANATION OF PART NUMBERS

MT	31	B	104	K	500	C	I
<b>Series</b> MT= Automotive (with AEC-Q200 qualification)	<b>Size (Inch (mm))</b> 31=1206 (3216)	<b>Dielectric</b> B=X7R	<b>Capacitance</b> 104=10x10 <sup>4</sup> =0.1uF	<b>Tolerance</b> K=±10%	<b>Rated voltage</b> 500=50 VDC	<b>Termination</b> C=Cu/Ni/Sn	<b>Packaging</b> T=7" reeled

## ■ CAPACITANCE RANGE

### NPO Dielectric

DIELECTRIC	Size	NPO							
		0402		0603		0805		1206	
RATED VOLTAGE (VDC)	10,16,25,50	10,16,25,50,100	200	10,16,25,50	100	10,16,25,50	100	100	
Capacitance	0.5pF (0R5)	N	S	S	A	A			
	0.6pF (0R6)	N	S	S	A	A			
	0.7pF (0R7)	N	S	S	A	A			
	0.8pF (0R8)	N	S	S	A	A			
	0.9pF (0R9)	N	S	S	A	A			
	1.0pF (1R0)	N	S	S	A	A			
	1.2pF (1R2)	N	S	S	A	A			
	1.5pF (1R5)	N	S	S	A	A	B	B	
	1.8pF (1R8)	N	S	S	A	A	B	B	
	2.2pF (2R2)	N	S	S	A	A	B	B	
	2.7pF (2R7)	N	S	S	A	A	B	B	
	3.3pF (3R3)	N	S	S	A	A	B	B	
	3.9pF (3R9)	N	S	S	A	A	B	B	
	4.7pF (4R7)	N	S	S	A	A	B	B	
	5.6pF (5R6)	N	S	S	A	A	B	B	
	6.8pF (6R8)	N	S	S	A	A	B	B	
	8.2pF (8R2)	N	S	S	A	A	B	B	
	10pF (100)	N	S	S	A	A	B	B	
	12pF (120)	N	S	S	A	A	B	B	
	15pF (150)	N	S	S	A	A	B	B	
	18pF (180)	N	S	S	A	A	B	B	
	22pF (220)	N	S	S	A	A	B	B	
	27pF (270)	N	S	S	A	A	B	B	
	33pF (330)	N	S	S	A	A	B	B	
	39pF (390)	N	S	S	A	A	B	B	
	47pF (470)	N	S	S	A	A	B	B	
	56pF (560)	N	S	S	A	A	B	B	
	68pF (680)	N	S	S	A	A	B	B	
	82pF (820)	N	S	S	A	A	B	B	
	100pF (101)	N	S	S	A	A	B	B	
	120pF (121)	N	S		A	A	B	B	
	150pF (151)	N	S		A	A	B	B	
	180pF (181)	N	S		A	A	B	B	
220pF (221)	N	S		A	A	B	B		
270pF (271)	N	S		A	A	B	B		
330pF (331)	N	S		A	A	B	B		
390pF (391)	N	S		B	B	B	B		
470pF (471)	N	S		B	B	B	B		
560pF (561)		S		B	B	B	B		
680pF (681)		S		B	B	B	B		
820pF (821)		S		B	B	B	B		
1,000pF (102)		S		B	B	B	B		
1,200pF (122)				B	B	B	B		
1,500pF (152)				B	B	B	B		
1,800pF (182)				B	B	B	B		
2,200pF (222)				B	B	B	B		
2,700pF (272)				D	B	B	B		
3,300pF (332)				D	B	B	B		
3,900pF (392)				D	B	B	B		
4,700pF (472)				D	B	B	B		
5,600pF (562)					B	B	B		
6,800pF (682)					C	C	C		
8,200pF (822)						D	D		
0.010uF (103)						D	D		

### X7R Dielectric

DIELECTRIC	Size	X7R							
		0402		0603		0805		1206	
RATED VOLTAGE (VDC)	10,16,25,50	10,16,25,50	10,16,25,50	10,16,25,50	10,16,25,50	10,16,25,50	10,16,25,50	100	
Capacitance	100pF (101)	N	N	S	S	B	B		
	120pF (121)	N	N	S	S	B	B		
	150pF (151)	N	N	S	S	B	B	B	B
	180pF (181)	N	N	S	S	B	B	B	B
	220pF (221)	N	N	S	S	B	B	B	B
	270pF (271)	N	N	S	S	B	B	B	B
	330pF (331)	N	N	S	S	B	B	B	B
	390pF (391)	N	N	S	S	B	B	B	B
	470pF (471)	N	N	S	S	B	B	B	B
	560pF (561)	N	N	S	S	B	B	B	B
	680pF (681)	N	N	S	S	B	B	B	B
	820pF (821)	N	N	S	S	B	B	B	B
	1,000pF (102)	N	N	S	S	B	B	B	B
	1,200pF (122)	N	N	S	S	B	B	B	B
	1,500pF (152)	N	N	S	S	B	B	B	B
	1,800pF (182)	N	N	S	S	B	B	B	B
	2,200pF (222)	N	N	S	S	B	B	B	B
	2,700pF (272)	N	N	S	S	B	B	B	B
	3,300pF (332)	N	N	S	S	B	B	B	B
	3,900pF (392)	N	N	S	S	B	B	B	B
	4,700pF (472)	N	N	S	S	B	B	B	B
	5,600pF (562)	N	N	S	S	B	B	B	B
	6,800pF (682)	N	N	S	S	B	B	B	B
	8,200pF (822)	N	N	S	S	B	B	B	B
	0.010uF (103)	N	N	S	S	B	B	B	B
	0.012uF (123)			S	S	B	B	B	B
	0.015uF (153)			S	S	B	B	B	B
	0.018uF (183)			S	S	B	B	B	B
	0.022uF (223)			S	S	B	B	B	B
	0.027uF (273)			S	S	B	B	B	B
	0.033uF (333)			S	X	B	B	B	B
	0.039uF (393)			S	X	B	B	B	B
	0.047uF (473)			S	X	B	B	B	B
0.056uF (563)			S	X	B	B	B	B	
0.068uF (683)			S	X	B	B	B	B	
0.082uF (823)			S	X	B	B	B	B	
0.10uF (104)			S	X	B	B	B	B	
0.12uF (124)					B	D	C	C	
0.15uF (154)						D	C	C	
0.18uF (184)						D	C	C	
0.22uF (224)						D	C	C	
0.27uF (274)							C	C	
0.33uF (334)							C	C	
0.39uF (394)							C	J	
0.47uF (474)							J	J	
0.56uF (564)							J	J	
0.68uF (684)							J	J	
0.82uF (824)							J	J	
1.0uF (105)							J	J	
1.5uF (155)									
2.2uF (225)									

1. The letter in cell is expressed the symbol of product thickness.  
2. For more information about products with special capacitance or other data, please contact WTC local representative.

# Automotive Capacitors without AEC-Q200

## MG Series

### FEATURES

- \* A wide selection of sizes is available (0402 to 1812).
- \* High capacitance in given case size.
- \* Capacitor with lead-free termination (pure Tin).
- \* High reliability design with severe quality controls.

### GENERAL ELECTRICAL DATA

Dielectric	NPO	X7R	X5R
Size	0402, 0603, 0805, 1206, 1210, 1812		
Capacitance range*	0.5pF to 0.033μF	100pF to 2.2μF	0.056μF to 10μF
Capacitance tolerance**	Cap≤5pF: B (±0.1pF), C (±0.25pF) 5pF<Cap<10pF: C (±0.25pF), D (±0.5pF) Cap≥10pF: F (±1%), G (±2%), J (±5%)	J (±5%), K (±10%), M (±20%)	
Rated voltage (WVDC)	16V, 25V, 50V, 100V	10V, 16V, 25V, 50V, 100V, 200V, 250V	6.3V, 10V, 16V, 25V
Operating temperature	-55 to +125°C		-55 to +85°C
Capacitance characteristic	±30ppm/°C		±15%
Termination	Ni/Sn (lead-free termination)		

### EXPLANATION OF PART NUMBERS

MG	31	B	104	K	500	C	T
<b>Series</b> MG= Automotive (without AEC-Q200 certification)	<b>Size (Inch (mm))</b> 31=1206 (3216)	<b>Dielectric</b> B=X7R	<b>Capacitance</b> 104=10x10 <sup>4</sup> =0.1uF	<b>Tolerance</b> K=±10%	<b>Rated voltage</b> 500=50 VDC	<b>Termination</b> C=Cu/Ni/Sn	<b>Packaging</b> T=7" reeled

\* Please refer to page 2 "How to order" for more information.

### CAPACITANCE RANGE

#### X5R Dielectric

Dielectric	X5R																	
	0402			0603				0805				1206				1210		
Size	6.3	10	16	6.3	10	16	25	6.3	10	16	25	6.3	10	16	25	10	16	
Rated Voltage(VDC)	6.3	10	16	6.3	10	16	25	6.3	10	16	25	6.3	10	16	25	10	16	
Capacitance	0.056μF (563)		N															
	0.068μF (683)		N															
	0.082μF (823)		N															
	0.10μF (104)		N	N														
	0.15μF (154)		N	N														
	0.22μF (224)	N	N	N				X										
	0.27μF (274)	N	N			X	X	X										
	0.33μF (334)	N	N			X	X	X										
	0.39μF (394)	N				X	X	X										
	0.47μF (474)	N				X	X	X										
	0.68μF (684)	N				X	X	X										
	0.82μF (824)	N			X	X	X	X										
	1.0μF (105)				X	X	X	X										
	1.5μF (155)								I	I				J	J	P	K	K
	2.2μF (225)								I	I	I	I		J	J	P	K	K
	3.3μF (335)										I	I	P	P	P	P	K	K
4.7μF (475)										I	I	P	P	P	P	K	K	
6.8μF (685)												P	P					
10μF (106)												P	P					

1. The letter in cell is expressed the symbol of product thickness.

2. For more information about products with special capacitance or other data, please contact WTC local representative.

## NP0 Dielectric

Dielectric		NP0												
Size		0402	0603	0805			1206		1210			1812		
Rated Voltage (VDC)		10,16, 25,50, 100	10,16, 25,50, 100	10,16, 25,50, 100	200	250	500, 630	10,16, 25,50,	100	10,16	25,50	100	10,16, 25,50	100
Capacitance	0.1pF (0R1)													
	0.2pF (0R2)													
	0.3pF (0R3)													
	0.4pF (0R4)													
	0.5pF (0R5)	N	S	A	A	A	A							
	0.6pF (0R6)	N	S	A	A	A	A							
	0.7pF (0R7)	N	S	A	A	A	A							
	0.8pF (0R8)	N	S	A	A	A	A							
	0.9pF (0R9)	N	S	A	A	A	A							
	1.0pF (1R0)	N	S	A	A	A	A							
	1.2pF (1R2)	N	S	A	A	A	A							
	1.5pF (1R5)	N	S	A	A	A	A	B	B					
	1.8pF (1R8)	N	S	A	A	A	A	B	B					
	2.2pF (2R2)	N	S	A	A	A	A	B	B					
	2.7pF (2R7)	N	S	A	A	A	A	B	B					
	3.3pF (3R3)	N	S	A	A	A	A	B	B					
	3.9pF (3R9)	N	S	A	A	A	A	B	B					
	4.7pF (4R7)	N	S	A	A	A	A	B	B					
	5.6pF (5R6)	N	S	A	A	A	A	B	B					
	6.8pF (6R8)	N	S	A	A	A	A	B	B					
	8.2pF (8R2)	N	S	A	A	A	A	B	B					
	10pF (100)	N	S	A	A	A	A	B	B	C	C	C	D	D
	12pF (120)	N	S	A	A	A	A	B	B	C	C	C	D	D
	15pF (150)	N	S	A	A	A	A	B	B	C	C	C	D	D
	18pF (180)	N	S	A	A	A	A	B	B	C	C	C	D	D
	22pF (220)	N	S	A	A	A	A	B	B	C	C	C	D	D
	27pF (270)	N	S	A	A	A	A	B	B	C	C	C	D	D
	33pF (330)	N	S	A	A	A	A	B	B	C	C	C	D	D
	39pF (390)	N	S	A	A	A	A	B	B	C	C	C	D	D
	47pF (470)	N	S	A	A	A	A	B	B	C	C	C	D	D
	56pF (560)	N	S	A	A	A	A	B	B	C	C	C	D	D
	68pF (680)	N	S	A	A	A	A	B	B	C	C	C	D	D
	82pF (820)	N	S	A	A	A	B	B	B	C	C	C	D	D
	100pF (101)	N	S	A	A	B	B	B	B	C	C	C	D	D
	120pF (121)	N	S	A	A	B	D	B	B	C	C	C	D	D
	150pF (151)	N	S	A	B	D	D	B	B	C	C	C	D	D
	180pF (181)	N	S	A	B	D	D	B	B	C	C	C	D	D
	220pF (221)	N	S	A	D	D	D	B	B	C	C	C	D	D
	270pF (271)		S	A	D	D	D	B	B	C	C	C	D	D
	330pF (331)		S	A	D	D	D	B	B	C	C	C	D	D
	390pF (391)		S	B	D	D	D	B	B	C	C	C	D	D
	470pF (471)		S	B	D			B	B	C	C	C	D	D
560pF (561)		S	B	D			B	B	C	C	C	D	D	
680pF (681)		S	B	D			B	B	C	C	C	D	D	
820pF (821)		S	B	D			B	B	C	C	C	D	D	
1,000pF (102)		S	B				B	B	C	C	C	D	D	
1,200pF (122)			B				B	B	C	C	C	D	D	
1,500pF (152)			B				B	B	C	C	C	D	D	
1,800pF (182)			B				B	B	C	C	C	D	D	
2,200pF (222)			B				B	B	C	C	C	D	D	
2,700pF (272)			D				B	B	C	C	C	D	D	
3,300pF (332)							B	B	C	C	C	D	D	
3,900pF (392)							B	B	C	C	C	D	D	
4,700pF (472)							B	B	C	C	C	D	D	
5,600pF (562)							B	B	C	C	C	D	D	
6,800pF (682)							C		C	C	C	D	D	
8,200pF (822)							D		C	C	C	D	D	
0.010uF (103)							D		C	C	C	D	D	
0.012uF (123)									C	D	D	D	D	
0.015uF (153)									C	D	D	D	D	
0.018uF (183)												D	D	
0.022uF (223)												D	D	
0.027uF (273)												D	D	
0.033uF (333)												D	D	

1. The letter in cell is expressed the symbol of product thickness.
2. The letter in cell with "A" mark is expressed product with Ag/Ni/Sn terminations.
3. For more information about products with special capacitance or other data, please contact WTC local representative.

# Automotive Capacitors without AEC-Q200 MG Series

## X7R Dielectric

Dielectric		X7R																											
		0402			0603				0805					1206					1210					1812					
Size		10, 16	25	50	6.3, 10, 16	25	50	100	10, 16	25	50	100	200, 250	10, 16	25	50	100	200, 250	10, 16	25	50	100	200, 250	10, 16, 25	50	100	200, 250		
Capacitance	100pF (101)	N	N	N	S	S	S	S	B	B	B	B	B																
	120pF (121)	N	N	N	S	S	S	S	B	B	B	B	B																
	150pF (151)	N	N	N	S	S	S	S	B	B	B	B	B	B	B	B	B	B											
	180pF (181)	N	N	N	S	S	S	S	B	B	B	B	B	B	B	B	B	B											
	220pF (221)	N	N	N	S	S	S	S	B	B	B	B	B	B	B	B	B	B											
	270pF (271)	N	N	N	S	S	S	S	B	B	B	B	B	B	B	B	B	B											
	330pF (331)	N	N	N	S	S	S	S	B	B	B	B	B	B	B	B	B	B											
	390pF (391)	N	N	N	S	S	S	S	B	B	B	B	B	B	B	B	B	B											
	470pF (471)	N	N	N	S	S	S	S	B	B	B	B	B	B	B	B	B	B											
	560pF (561)	N	N	N	S	S	S	S	B	B	B	B	B	B	B	B	B	B											
	680pF (681)	N	N	N	S	S	S	S	B	B	B	B	B	B	B	B	B	B											
	820pF (821)	N	N	N	S	S	S	S	B	B	B	B	B	B	B	B	B	B											
	1,000pF (102)	N	N	N	S	S	S	S	B	B	B	B	B	B	B	B	B	B	B	C	C	C	C	C	C	D	D	D	D
	1,200pF (122)	N	N	N	S	S	S	S	B	B	B	B	B	B	B	B	B	B	B	C	C	C	C	C	C	D	D	D	D
	1,500pF (152)	N	N	N	S	S	S	S	B	B	B	B	B	B	B	B	B	B	B	C	C	C	C	C	C	D	D	D	D
	1,800pF (182)	N	N	N	S	S	S	S	B	B	B	B	B	B	B	B	B	B	B	C	C	C	C	C	C	D	D	D	D
	2,200pF (222)	N	N	N	S	S	S	S	B	B	B	B	B	B	B	B	B	B	B	C	C	C	C	C	C	D	D	D	D
	2,700pF (272)	N	N	N	S	S	S	S	B	B	B	B	B	B	B	B	B	B	B	C	C	C	C	C	C	D	D	D	D
	3,300pF (332)	N	N	N	S	S	S	S	B	B	B	B	B	B	B	B	B	B	B	C	C	C	C	C	C	D	D	D	D
	3,900pF (392)	N	N	N	S	S	S	S	B	B	B	B	B	B	B	B	B	B	B	C	C	C	C	C	C	D	D	D	D
	4,700pF (472)	N	N	N	S	S	S	S	B	B	B	B	B	B	B	B	B	B	B	C	C	C	C	C	C	D	D	D	D
	5,600pF (562)	N	N	N	S	S	S	S	B	B	B	B	B	D	B	B	B	B	B	C	C	C	C	C	C	D	D	D	D
	6,800pF (682)	N	N	N	S	S	S	S	B	B	B	B	B	D	B	B	B	B	B	C	C	C	C	C	C	D	D	D	D
	8,200pF (822)	N	N	N	S	S	S	S	B	B	B	B	B	D	B	B	B	B	B	C	C	C	C	C	C	D	D	D	D
	0.010uF (103)	N	N	N	S	S	S	S	B	B	B	B	B	D	B	B	B	B	B	C	C	C	C	C	C	D	D	D	D
	0.012uF (123)	N	N		S	S	S		B	B	B	B	B	D	B	B	B	B	B	C	C	C	C	C	C	D	D	D	D
	0.015uF (153)	N	N		S	S	S		B	B	B	B	B	D	B	B	B	B	B	C	C	C	C	C	C	D	D	D	D
	0.018uF (183)	N	N		S	S	S		B	B	B	B	B	D	B	B	B	B	B	C	C	C	C	C	C	D	D	D	D
	0.022uF (223)	N	N		S	S	S		B	B	B	B	B	D	B	B	B	B	B	C	C	C	C	C	C	D	D	D	D
	0.027uF (273)	N	N		S	S	S		B	B	B	D		B	B	B	B	B	B	C	C	C	C	C	C	D	D	D	D
	0.033uF (333)	N	N		S	S	X		B	B	B	D		B	B	B	B	B	G	C	C	C	C	C	C	D	D	D	D
	0.039uF (393)	N	N		S	S	X		B	B	B	D		B	B	B	B	B	G	C	C	C	C	C	C	D	D	D	D
	0.047uF (473)	N	N		S	S	X		B	B	B	D		B	B	B	B	B	G	C	C	C	C	C	D	D	D	D	D
0.056uF (563)	N			S	S	X		B	B	B	D		B	B	B	B	B	G	C	C	C	C	C	D	D	D	D	D	
0.068uF (683)	N			S	S	X		B	B	B	D		B	B	B	B	B	G	C	C	C	C	C	G	D	D	D	D	
0.082uF (823)	N			S	S	X		B	B	B	D		B	B	B	D	G	C	C	C	C	C	G	D	D	D	D	D	
0.10uF (104)	N			S	S	X		B	B	B	D		B	B	B	D	G	C	C	C	C	C	G	D	D	D	D	D	
0.12uF (124)				S	X			D	D	D				B	B	B	D		C	C	C	C	G	D	D	D	D	D	
0.15uF (154)				S	X			D	D	D				C	C	C	G		C	C	C	D	M	D	D	D	K		
0.18uF (184)				S	X			D	D	D				C	C	C	G		C	C	C	D	M	D	D	D	K		
0.22uF (224)				S	X			D	D	D				C	C	C	G		C	C	C	D	M	D	D	D	K		
0.27uF (274)				X				D	D					C	C	D			C	C	C	G	M	D	D	D	K		
0.33uF (334)				X				D	D					C	C	D			C	C	D	G	M	D	D	D	K		
0.39uF (394)				X				D	D					C	J	P			C	C	D	M	M	D	D	D	K		
0.47uF (474)				X				D	D					J	J	P			C	C	D	M	M	D	D	K	K		
0.56uF (564)								D	D					J	J	P			D	D	D	M		D	D	K			
0.68uF (684)								D	D					J	J	P			D	D	D	K		D	K	K			
0.82uF (824)								D	D					J	J	P			D	D	D	K		D	K	K			
1.0uF (105)								D						J	J	P			D	D	D	K		D	K	K			
1.5uF (155)														J	P				K	G							K		
2.2uF (225)														J	P				K	G							M		

1. The letter in cell is expressed the symbol of product thickness.

2. For more information about products with special capacitance or other data, please contact WTC local representative.

## ■ FEATURES

- \* High density mounting due to mounting space saving.
- \* Mounting cost saving.
- \* Increased throughput.

## ■ GENERAL ELECTRICAL DATA

Dielectric	NPO	X7R
Size	4x0402	4x0402
Capacitance range*	10pF to 220pF	1000pF to 0.1μF
Capacitance tolerance**	J (±5%), K (±10%)	K (±10%), M (±20%)
Rated voltage (WVDC)	50V	10V, 16V, 25V
Insulation resistance at Ur	≥10GΩ or RxC≥500ΩxF whichever is less	
Operating temperature	-55 to +125°C	
Capacitance characteristic	±30ppm	±15%
Termination	Ni/Sn (lead-free termination)	

## ■ EXPLANATION OF PART NUMBERS

MY	24	N	102	J	500	C	T
<b>Series</b> MY= Automotive Capacitor array (with AEC-Q200 qualification)	<b>Size (Inch (mm))</b> 24=4x0402	<b>Dielectric</b> N=NP0 (C0G) B=X7R	<b>Capacitance</b> 102=10x10 <sup>2</sup> =1000pFuF	<b>Tolerance</b> J=±5%	<b>Rated voltage</b> 500=50 VDC	<b>Termination</b> C=Cu/Ni/Sn	<b>Packaging</b> T=7" reeled G=13" reeled

\* Please refer to page 2 "How to order" for more information.

## ■ CAPACITANCE RANGE

Size	4 x 0402				
Dielectric	NPO	X7R			
Rated Voltage(VDC)	50	10	16	25	
Capacitance	10pF (100)	T			
	15pF (150)	T			
	22pF (220)	T			
	33pF (330)	T			
	47pF (470)	T			
	68pF (680)	T			
	100pF (101)	T			
	150pF (151)	T			
	180pF (181)	T			
	220pF (221)	T			
	270pF (271)				
	330pF (331)				
	470pF (471)				
	6,80pF (681)				
	1,000pF (102)		T	T	T
	1,500pF (152)		T	T	T
	2,200pF (222)		T	T	T
	3,300pF (332)		T	T	T
	4,700pF (472)		T	T	T
	6,800pF (682)		T	T	T
	0.010μF (103)		T	T	T
	0.015μF (153)		T	T	T
	0.022μF (223)		T	T	T
	0.033μF (333)		T	T	T
0.047μF (473)		T	T	T	
0.068μF (683)		T	T	T	
0.10μF (104)		T	T	T	

1. The letter in cell is expressed the symbol of product thickness.

2. For more information about products with special capacitance or other data, please contact WTC local representative.

# Appendix I : Reliability Test Conditions and Requirements

\* About Reliability Test Conditions and Requirements, please refer to Walsin MLCC approval sheet for more detail.

No	Item	Test Condition	Requirements																																																																																																		
1.	Visual and Mechanical	---	* No remarkable defect. * Dimensions to conform to individual specification sheet.																																																																																																		
2.	Capacitance	Class I: NPO Cap≤1000pF 1.0±0.2Vrms, 1MHz±10% Cap>1000pF 1.0±0.2Vrms, 1KHz±10%	* Shall not exceed the limits given in the detailed spec.																																																																																																		
3.	Q/ D.F. (Dissipation Factor)	Class II * : X7R,X7E, X6S, X5R,Y5V Cap≤10μF, 1.0±0.2Vrms, 1kHz±10% ** Cap>10μF, 0.5±0.2Vrms, 120Hz±20%  ** Test condition: 0.5±0.2Vrms, 1KHz±10% X7R: 0603≥225(10V), 0805=106(6.3V&10V) X5R: 01R5≥103, 0201≥224 (6.3V,10V), 0402≥475 (6.3V), 0402≥225(10V), 0603=106 (6.3V,10V), TT18X≥475(10V) , TT15X series X6S:0201≥224 (6.3V),0402≥225 (6.3V),  * Preconditioning for Class II MLCC: Perform a heat treatment at 150±10°C for 1 hour, then leave in ambient condition for 24±2 hours before measurement.	NPO: Cap≥30pF, Q≥1000; Cap<30pF,Q≥400+20C X7R,, X6S, X5R: <table border="1"> <thead> <tr> <th>Rated vol.</th> <th>D.F.≤</th> <th colspan="2">Exception of D.F. ≤</th> </tr> </thead> <tbody> <tr> <td>≥100V</td> <td>≤2.5%</td> <td>≤3%</td> <td>1206±0.47μF</td> </tr> <tr> <td></td> <td></td> <td>≤5%</td> <td>0805±0.1μF, 0603±0.068μF</td> </tr> <tr> <td rowspan="2">50V</td> <td rowspan="2">≤2.5%</td> <td>≤3%</td> <td>0201(50V); 0603±0.047μF; 0805±0.18μF; 1206±0.47μF</td> </tr> <tr> <td>≤5%</td> <td>1210±4.7μF</td> </tr> <tr> <td></td> <td></td> <td>≤10%</td> <td>0402±0.1μF; 0603±1μF; 0805±1μF; 1206±2.2μF; 1210±10μF; TT series</td> </tr> <tr> <td>35V</td> <td>≤3.5%</td> <td>≤10%</td> <td>0603±1μF;0805±2.2μF; 1210±10μF</td> </tr> <tr> <td rowspan="3">25V</td> <td rowspan="3">≤3.5%</td> <td>≤5%</td> <td>0201±0.01μF;0805±1μF; 1210±10μF</td> </tr> <tr> <td>≤7%</td> <td>0603±0.33μF; 1206±4.7μF</td> </tr> <tr> <td>≤10%</td> <td>0402±0.1μF;0603±0.47μF; 0805±2.2μF; 1206±6.8μF; 1210±22μF ; TT series</td> </tr> <tr> <td></td> <td></td> <td>≤12.5%</td> <td>0402±1μF</td> </tr> <tr> <td rowspan="2">16V</td> <td rowspan="2">≤3.5%</td> <td>≤5%</td> <td>0201±0.01μF; 0402±0.033μF; 0603±0.15μF; 0805±0.68μF; 1206±2.2μF; 1210±4.7μF</td> </tr> <tr> <td>≤10%</td> <td>0201±0.1μF;0402±0.22μF;0603±0.68μF;0805±2.2μF; 1206±4.7μF; 1210±22μF; TT series</td> </tr> <tr> <td rowspan="2">10V</td> <td rowspan="2">≤5%</td> <td>≤10%</td> <td>0201±0.012μF;0402±0.33μF;0603±0.33μF; 0805±2.2μF;1206±2.2μF;1210±22μF; TT series</td> </tr> <tr> <td>≤15%</td> <td>0201±0.1μF; 0402±1μF</td> </tr> <tr> <td rowspan="2">6.3V</td> <td rowspan="2">≤10%</td> <td>≤15%</td> <td>0201±0.1μF;0402±1μF;0603±10μF; 0805±4.7μF; 1206±4.7μF ;1210±100μF; TT series</td> </tr> <tr> <td>≤20%</td> <td>0402±2.2μF</td> </tr> <tr> <td>4V</td> <td>≤15%</td> <td>---</td> <td>---</td> </tr> </tbody> </table> X7R/X7E, LD series : 100V: DF≤1.4%; ≤200V:DF≤1.0% Y5V: <table border="1"> <thead> <tr> <th>Rated vol.</th> <th>D.F. ≤</th> <th colspan="2">Exception of D.F.≤</th> </tr> </thead> <tbody> <tr> <td>≥50V</td> <td>≤5%</td> <td>≤7%</td> <td>0603±0.1μF; 0805±0.47μF; 1206±4.7μF; TT series &amp; Cap≥1μF</td> </tr> <tr> <td>35V</td> <td>≤7%</td> <td>---</td> <td>---</td> </tr> <tr> <td rowspan="2">25V</td> <td rowspan="2">≤5%</td> <td>≤7%</td> <td>0402±0.047μF;0603±0.1μF; 0805±0.33μF;1206±1μF; 1210±4.7μF</td> </tr> <tr> <td>≤9%</td> <td>0402±0.068μF;0603±0.47μF; 1206±4.7μF; 1210±22μF; TT series &amp; Cap≥1μF</td> </tr> <tr> <td>16V (C&lt;1.0μF)</td> <td>≤7%</td> <td>≤9%</td> <td>0402±0.068μF; 0603±0.68μF</td> </tr> <tr> <td></td> <td></td> <td>≤12.5%</td> <td>0402±0.22μF</td> </tr> <tr> <td>16V (C≥1.0μF)</td> <td>≤9%</td> <td>≤12.5%</td> <td>0603±2.2μF; 0805±3.3μF;1206±10μF; 1210±22μF; 1812±47μF; TT series &amp; Cap≥1μF</td> </tr> <tr> <td>10V</td> <td>≤12.5%</td> <td>≤20%</td> <td>0402±0.47μF</td> </tr> <tr> <td>6.3V</td> <td>≤20%</td> <td>---</td> <td>---</td> </tr> </tbody> </table>	Rated vol.	D.F.≤	Exception of D.F. ≤		≥100V	≤2.5%	≤3%	1206±0.47μF			≤5%	0805±0.1μF, 0603±0.068μF	50V	≤2.5%	≤3%	0201(50V); 0603±0.047μF; 0805±0.18μF; 1206±0.47μF	≤5%	1210±4.7μF			≤10%	0402±0.1μF; 0603±1μF; 0805±1μF; 1206±2.2μF; 1210±10μF; TT series	35V	≤3.5%	≤10%	0603±1μF;0805±2.2μF; 1210±10μF	25V	≤3.5%	≤5%	0201±0.01μF;0805±1μF; 1210±10μF	≤7%	0603±0.33μF; 1206±4.7μF	≤10%	0402±0.1μF;0603±0.47μF; 0805±2.2μF; 1206±6.8μF; 1210±22μF ; TT series			≤12.5%	0402±1μF	16V	≤3.5%	≤5%	0201±0.01μF; 0402±0.033μF; 0603±0.15μF; 0805±0.68μF; 1206±2.2μF; 1210±4.7μF	≤10%	0201±0.1μF;0402±0.22μF;0603±0.68μF;0805±2.2μF; 1206±4.7μF; 1210±22μF; TT series	10V	≤5%	≤10%	0201±0.012μF;0402±0.33μF;0603±0.33μF; 0805±2.2μF;1206±2.2μF;1210±22μF; TT series	≤15%	0201±0.1μF; 0402±1μF	6.3V	≤10%	≤15%	0201±0.1μF;0402±1μF;0603±10μF; 0805±4.7μF; 1206±4.7μF ;1210±100μF; TT series	≤20%	0402±2.2μF	4V	≤15%	---	---	Rated vol.	D.F. ≤	Exception of D.F.≤		≥50V	≤5%	≤7%	0603±0.1μF; 0805±0.47μF; 1206±4.7μF; TT series & Cap≥1μF	35V	≤7%	---	---	25V	≤5%	≤7%	0402±0.047μF;0603±0.1μF; 0805±0.33μF;1206±1μF; 1210±4.7μF	≤9%	0402±0.068μF;0603±0.47μF; 1206±4.7μF; 1210±22μF; TT series & Cap≥1μF	16V (C<1.0μF)	≤7%	≤9%	0402±0.068μF; 0603±0.68μF			≤12.5%	0402±0.22μF	16V (C≥1.0μF)	≤9%	≤12.5%	0603±2.2μF; 0805±3.3μF;1206±10μF; 1210±22μF; 1812±47μF; TT series & Cap≥1μF	10V	≤12.5%	≤20%	0402±0.47μF	6.3V	≤20%	---	---
Rated vol.	D.F.≤	Exception of D.F. ≤																																																																																																			
≥100V	≤2.5%	≤3%	1206±0.47μF																																																																																																		
		≤5%	0805±0.1μF, 0603±0.068μF																																																																																																		
50V	≤2.5%	≤3%	0201(50V); 0603±0.047μF; 0805±0.18μF; 1206±0.47μF																																																																																																		
		≤5%	1210±4.7μF																																																																																																		
		≤10%	0402±0.1μF; 0603±1μF; 0805±1μF; 1206±2.2μF; 1210±10μF; TT series																																																																																																		
35V	≤3.5%	≤10%	0603±1μF;0805±2.2μF; 1210±10μF																																																																																																		
25V	≤3.5%	≤5%	0201±0.01μF;0805±1μF; 1210±10μF																																																																																																		
		≤7%	0603±0.33μF; 1206±4.7μF																																																																																																		
		≤10%	0402±0.1μF;0603±0.47μF; 0805±2.2μF; 1206±6.8μF; 1210±22μF ; TT series																																																																																																		
		≤12.5%	0402±1μF																																																																																																		
16V	≤3.5%	≤5%	0201±0.01μF; 0402±0.033μF; 0603±0.15μF; 0805±0.68μF; 1206±2.2μF; 1210±4.7μF																																																																																																		
		≤10%	0201±0.1μF;0402±0.22μF;0603±0.68μF;0805±2.2μF; 1206±4.7μF; 1210±22μF; TT series																																																																																																		
10V	≤5%	≤10%	0201±0.012μF;0402±0.33μF;0603±0.33μF; 0805±2.2μF;1206±2.2μF;1210±22μF; TT series																																																																																																		
		≤15%	0201±0.1μF; 0402±1μF																																																																																																		
6.3V	≤10%	≤15%	0201±0.1μF;0402±1μF;0603±10μF; 0805±4.7μF; 1206±4.7μF ;1210±100μF; TT series																																																																																																		
		≤20%	0402±2.2μF																																																																																																		
4V	≤15%	---	---																																																																																																		
Rated vol.	D.F. ≤	Exception of D.F.≤																																																																																																			
≥50V	≤5%	≤7%	0603±0.1μF; 0805±0.47μF; 1206±4.7μF; TT series & Cap≥1μF																																																																																																		
35V	≤7%	---	---																																																																																																		
25V	≤5%	≤7%	0402±0.047μF;0603±0.1μF; 0805±0.33μF;1206±1μF; 1210±4.7μF																																																																																																		
		≤9%	0402±0.068μF;0603±0.47μF; 1206±4.7μF; 1210±22μF; TT series & Cap≥1μF																																																																																																		
16V (C<1.0μF)	≤7%	≤9%	0402±0.068μF; 0603±0.68μF																																																																																																		
		≤12.5%	0402±0.22μF																																																																																																		
16V (C≥1.0μF)	≤9%	≤12.5%	0603±2.2μF; 0805±3.3μF;1206±10μF; 1210±22μF; 1812±47μF; TT series & Cap≥1μF																																																																																																		
10V	≤12.5%	≤20%	0402±0.47μF																																																																																																		
6.3V	≤20%	---	---																																																																																																		
4a.	Dielectric Strength	*To apply voltage(≤100V) 250%. *Duration: 1 to 5 sec. *Charge & discharge current less than 50mA.  *To apply voltage: 200V ~300V & LD series ≥2 times V DC 500V ~ 999V ≥1.5 times V DC 1000V ~ 3000V ≥1.2 times V DC *Cut-off, set at 10mA *TEST= 15 sec. *RAMP=0	*No evidence of damage or flash over during test.																																																																																																		
4b.	Dielectric Strength (for X1/Y2 & X2/Y3)	* To apply 1500 VAC voltage. * Duration: 60 sec.	* No evidence of damage or flash over during test.																																																																																																		
5.	Insulation Resistance	To apply rated voltage for max. 120 sec.	10GΩ or RxC≥500Ω-F whichever is smaller. Class II (X7R, X7E, X6S, X5R, Y5V) <table border="1"> <thead> <tr> <th>Rated voltage</th> <th>Insulation Resistance</th> </tr> </thead> <tbody> <tr> <td>100V: X7R</td> <td rowspan="7">10GΩ or RxC≥100 Ω-F whichever is smaller.</td> </tr> <tr> <td>50V:0603±1μF;0805±1μF;1206±2.2μF;1210±4.7μF</td> </tr> <tr> <td>35V:0805±2.2μF;1210±10μF</td> </tr> <tr> <td>25V:0402±1μF;0603±2.2μF;0805±2.2μF;1206±10μF;1210±10μF</td> </tr> <tr> <td>16V:0201±0.1μF;0402±0.22μF;0603±1μF;0805±2.2μF;1206±10μF;1210±47μF</td> </tr> <tr> <td>10V:0201±47nF;0402±0.47μF;0603±0.47μF; 0805±2.2μF; 1206±4.7μF;1210±47μF</td> </tr> <tr> <td>6.3V ; 4V ; TT series</td> </tr> <tr> <td>50V: 0402±0.1μF</td> <td rowspan="2">RxC≥50 Ω-F</td> </tr> <tr> <td>35V:0603±1μF</td> </tr> <tr> <td>10V:0603±10μF</td> <td></td> </tr> </tbody> </table> Rated Voltage: 200V ~ 630V To apply rated voltage (500V max.) for 60 sec. >10GΩ or 100Ω-F whichever is smaller. Rated Voltage: >630V To apply 500V for 60sec. >10GΩ	Rated voltage	Insulation Resistance	100V: X7R	10GΩ or RxC≥100 Ω-F whichever is smaller.	50V:0603±1μF;0805±1μF;1206±2.2μF;1210±4.7μF	35V:0805±2.2μF;1210±10μF	25V:0402±1μF;0603±2.2μF;0805±2.2μF;1206±10μF;1210±10μF	16V:0201±0.1μF;0402±0.22μF;0603±1μF;0805±2.2μF;1206±10μF;1210±47μF	10V:0201±47nF;0402±0.47μF;0603±0.47μF; 0805±2.2μF; 1206±4.7μF;1210±47μF	6.3V ; 4V ; TT series	50V: 0402±0.1μF	RxC≥50 Ω-F	35V:0603±1μF	10V:0603±10μF																																																																																				
Rated voltage	Insulation Resistance																																																																																																				
100V: X7R	10GΩ or RxC≥100 Ω-F whichever is smaller.																																																																																																				
50V:0603±1μF;0805±1μF;1206±2.2μF;1210±4.7μF																																																																																																					
35V:0805±2.2μF;1210±10μF																																																																																																					
25V:0402±1μF;0603±2.2μF;0805±2.2μF;1206±10μF;1210±10μF																																																																																																					
16V:0201±0.1μF;0402±0.22μF;0603±1μF;0805±2.2μF;1206±10μF;1210±47μF																																																																																																					
10V:0201±47nF;0402±0.47μF;0603±0.47μF; 0805±2.2μF; 1206±4.7μF;1210±47μF																																																																																																					
6.3V ; 4V ; TT series																																																																																																					
50V: 0402±0.1μF	RxC≥50 Ω-F																																																																																																				
35V:0603±1μF																																																																																																					
10V:0603±10μF																																																																																																					
6.	Temperature Coefficient	With no electrical load. <table border="1"> <thead> <tr> <th>T.C.</th> <th>Operating Temp</th> </tr> </thead> <tbody> <tr> <td>NPO (C0G)</td> <td>-55~125°C at 25°C</td> </tr> <tr> <td>NPO (C0H)</td> <td>-55~125°C at 25°C</td> </tr> <tr> <td>NPO (C0J)</td> <td>-55~125°C at 25°C</td> </tr> <tr> <td>X7R</td> <td>-55~125°C at 25°C</td> </tr> <tr> <td>X7E</td> <td>-55~125°C at 25°C</td> </tr> <tr> <td>X6S</td> <td>-55~105°C at 25°C</td> </tr> <tr> <td>X5R</td> <td>-55~ 85°C at 25°C</td> </tr> <tr> <td>Y5V</td> <td>-25~ 85°C at 20°C</td> </tr> </tbody> </table>	T.C.	Operating Temp	NPO (C0G)	-55~125°C at 25°C	NPO (C0H)	-55~125°C at 25°C	NPO (C0J)	-55~125°C at 25°C	X7R	-55~125°C at 25°C	X7E	-55~125°C at 25°C	X6S	-55~105°C at 25°C	X5R	-55~ 85°C at 25°C	Y5V	-25~ 85°C at 20°C	<table border="1"> <thead> <tr> <th>T.C.</th> <th>Capacitance Change</th> </tr> </thead> <tbody> <tr> <td>NPO (C0G)</td> <td>Within ±30ppm/°C</td> </tr> <tr> <td>NPO (C0H)</td> <td>Within ±60ppm/°C</td> </tr> <tr> <td>NPO (C0J)</td> <td>Within ±120ppm/°C</td> </tr> <tr> <td>X7R</td> <td>Within ±15%</td> </tr> <tr> <td>X7E</td> <td>Within ±4.7%</td> </tr> <tr> <td>X6S</td> <td>Within ±22%</td> </tr> <tr> <td>X5R</td> <td>Within ±15%</td> </tr> <tr> <td>Y5V</td> <td>Within +30%/ -80%</td> </tr> </tbody> </table>	T.C.	Capacitance Change	NPO (C0G)	Within ±30ppm/°C	NPO (C0H)	Within ±60ppm/°C	NPO (C0J)	Within ±120ppm/°C	X7R	Within ±15%	X7E	Within ±4.7%	X6S	Within ±22%	X5R	Within ±15%	Y5V	Within +30%/ -80%																																																														
T.C.	Operating Temp																																																																																																				
NPO (C0G)	-55~125°C at 25°C																																																																																																				
NPO (C0H)	-55~125°C at 25°C																																																																																																				
NPO (C0J)	-55~125°C at 25°C																																																																																																				
X7R	-55~125°C at 25°C																																																																																																				
X7E	-55~125°C at 25°C																																																																																																				
X6S	-55~105°C at 25°C																																																																																																				
X5R	-55~ 85°C at 25°C																																																																																																				
Y5V	-25~ 85°C at 20°C																																																																																																				
T.C.	Capacitance Change																																																																																																				
NPO (C0G)	Within ±30ppm/°C																																																																																																				
NPO (C0H)	Within ±60ppm/°C																																																																																																				
NPO (C0J)	Within ±120ppm/°C																																																																																																				
X7R	Within ±15%																																																																																																				
X7E	Within ±4.7%																																																																																																				
X6S	Within ±22%																																																																																																				
X5R	Within ±15%																																																																																																				
Y5V	Within +30%/ -80%																																																																																																				
7.	Adhesive Strength of Termination	*Pressurizing force: 01005:1N, 0201:2N, 0402 & 0603: 5N >0603: 10N *Test time:10 ±1 sec	* No remarkable damage or removal of the terminations.																																																																																																		

# Appendix I : Reliability Test Conditions and Requirements

No	Item	Test Condition	Requirements																																																																																																	
8.	Vibration Resistance	<ul style="list-style-type: none"> <li>* Vibration frequency: 10~55 Hz/min.</li> <li>* Total amplitude: 1.5mm</li> <li>* Test time: 6 hrs.</li> </ul> (Two hrs each in three mutually perpendicular directions.) * Measurement to be made after keeping at room temp. for 24±2 hrs.	<ul style="list-style-type: none"> <li>* No remarkable defect.</li> <li>* Dimensions to conform to individual specification sheet.</li> </ul>																																																																																																	
9.	Solderability	<ul style="list-style-type: none"> <li>* Solder temperature: 235±5°C</li> <li>* Dipping time: 2±0.5 sec.</li> </ul>	95% min. coverage of all metalized area.																																																																																																	
10.	Bending Test	*The middle part of substrate shall be pressurized by means of the pressurizing rod at a rate of about 1 mm per second until the deflection becomes 1 mm / SH series: 5 mm** & 3 mm*** and then the pressure shall be maintained for 5±1 sec. *Measurement to be made after keeping at room temp. for 24±2 hrs. (** Thickness >1.0mm; *** Thickness≤1.0mm)	<ul style="list-style-type: none"> <li>* No remarkable damage.</li> <li>* Cap change: NP0: within ±5% or 0.5pF whichever is larger X7R, X7E, X6S, X5R: within ±12.5% , Y5V: within ±30% (This capacitance change means the change of capacitance under specified flexure of substrate from the capacitance measured before the test.)</li> </ul>																																																																																																	
11.	Resistance to Soldering Heat	<ul style="list-style-type: none"> <li>* Solder temperature: 260±5°C</li> <li>* Dipping time: 10±1 sec</li> <li>* Preheating: 120 to 150°C for 1 minute before immerse the capacitor in a eutectic solder.</li> <li>* Before initial measurement (Class II only): Perform 150+0/-10°C for 1 hr and then set for 24±2 hrs at room temp.</li> <li>* Measurement to be made after keeping at room temp. for 24±2 hrs.</li> </ul>	<ul style="list-style-type: none"> <li>* No remarkable damage.</li> <li>* Cap change: NP0: within ±2.5% or 0.25pF whichever is larger X7R, X7E, X6S, X5R: within ±7.5% Y5V: within ±20% * Q/D.F., I.R. and dielectric strength: To meet initial requirements.</li> <li>* 25% max. leaching on each edge.</li> </ul>																																																																																																	
12.	Temperature Cycle	<ul style="list-style-type: none"> <li>* Conduct the five cycles according to the temperatures and time.</li> </ul> <table border="1"> <thead> <tr> <th>Step</th> <th>Temp. (°C)</th> <th>Time (min.)</th> </tr> </thead> <tbody> <tr> <td>1</td> <td>Min. operating temp. +0/-3</td> <td>30±3</td> </tr> <tr> <td>2</td> <td>Room temp.</td> <td>2~3</td> </tr> <tr> <td>3</td> <td>Max. operating temp. +3/-0</td> <td>30±3</td> </tr> <tr> <td>4</td> <td>Room temp.</td> <td>2~3</td> </tr> </tbody> </table> <ul style="list-style-type: none"> <li>* Before initial measurement (Class II only): Perform 150+0/-10°C for 1 hr and then set for 24±2 hrs at room temp.</li> <li>* Measurement to be made after keeping at room temp. for 24±2 hrs.</li> </ul>	Step	Temp. (°C)	Time (min.)	1	Min. operating temp. +0/-3	30±3	2	Room temp.	2~3	3	Max. operating temp. +3/-0	30±3	4	Room temp.	2~3	<ul style="list-style-type: none"> <li>* No remarkable damage.</li> <li>* Cap change: NP0: within ±2.5% or 0.25pF whichever is larger X7R, X7E, X6S, X5R: within ±7.5% Y5V: within ±20% * Q/D.F., I.R. and dielectric strength: To meet initial requirements.</li> </ul>																																																																																		
Step	Temp. (°C)	Time (min.)																																																																																																		
1	Min. operating temp. +0/-3	30±3																																																																																																		
2	Room temp.	2~3																																																																																																		
3	Max. operating temp. +3/-0	30±3																																																																																																		
4	Room temp.	2~3																																																																																																		
13.	Humidity (Damp Heat) Steady State	<ul style="list-style-type: none"> <li>* Test temp.: 40±2°C</li> <li>* Humidity: 90~95% RH</li> <li>* Test time: 500+24/0hrs.</li> <li>*Before initial measurement (Class II only): Perform 150+0/-10°C for 1 hr and then set for 24±2 hrs at room temp.</li> <li>* Measurement to be made after keeping at room temp. for 24±2 hrs.</li> </ul>	<ul style="list-style-type: none"> <li>* No remarkable damage.</li> <li>* Cap change: NP0: within ±5% or 0.5pF whichever is larger X7R, X7E, X6S, X5R: ≥10V**, within ±12.5%; 6.3V within ±25%; TT series, within ±25% **10V:0603≥4.7μF;0402≥1μF;0201≥0.1μF, within ±25%; Y5V: ≥10V, within ±30%; 6.3V, within +30/-40% * Q/D.F. value: NP0: More than 30pF Q≥350, 10pF≤C≤30pF, Q≥275+2.5C, Less than 10pF Q≥200+10C X7R, X6S, X5R:</li> </ul> <table border="1"> <thead> <tr> <th>Rated vol.</th> <th>D.F.≤</th> <th>Exception of D.F.≤</th> </tr> </thead> <tbody> <tr> <td rowspan="2">≥100V</td> <td rowspan="2">≤3%</td> <td>≤6%</td> <td>1206±0.47μF</td> </tr> <tr> <td>≤7.5%</td> <td>0805±0.1μF; 0603±0.068μF</td> </tr> <tr> <td rowspan="3">≥50V</td> <td rowspan="3">≤3%</td> <td>≤6%</td> <td>0201(50V);0603±0.047μF; 0805±0.18μF; 1206±0.47μF</td> </tr> <tr> <td>≤10%</td> <td>1210±4.7μF</td> </tr> <tr> <td>≤20%</td> <td>0402±0.1μF;0603±1μF; 0805±1μF; 1206±2.2μF; 1210±10μF; TT series</td> </tr> <tr> <td>35V</td> <td>≤5%</td> <td>≤20%</td> <td>0603±1μF; 0805±2.2μF; 1210±10μF</td> </tr> <tr> <td rowspan="4">25V</td> <td rowspan="4">≤5%</td> <td>≤10%</td> <td>0201±0.01μF;0805±1μF; 1210±10μF</td> </tr> <tr> <td>≤14%</td> <td>0603±0.33μF;1206±4.7μF</td> </tr> <tr> <td>≤15%</td> <td>0402±0.10μF;0603±0.47μF;0805±2.2μF;1206±6.8μF; 1210±22μF; TT series</td> </tr> <tr> <td>≤20%</td> <td>0402±1μF</td> </tr> <tr> <td rowspan="2">16V</td> <td rowspan="2">≤5%</td> <td>≤10%</td> <td>0603±0.15μF;0805±0.68μF;1206±2.2μF;1210±4.7μF</td> </tr> <tr> <td>≤15%</td> <td>0201±0.01μF;0402±0.033μF;0603±0.68μF;0805±2.2μF;1206±4.7μF; 1210±22μF; TT series</td> </tr> <tr> <td rowspan="2">10V</td> <td rowspan="2">≤7.5%</td> <td>≤15%</td> <td>0201±0.012μF;0402±0.33μF; 0603±0.33μF;0805±2.2μF 1206±2.2μF; 1210±22μF</td> </tr> <tr> <td>≤20%</td> <td>0201±0.1μF ;0402±1μF; TT series</td> </tr> <tr> <td>6.3V</td> <td>≤15%</td> <td>≤30%</td> <td>0201±0.1μF;0402±1μF;0603±10μF; 0805±4.7μF;1206±47μF;1210±100μF;TT series</td> </tr> <tr> <td>4V</td> <td>≤20%</td> <td>---</td> <td>---</td> </tr> </tbody> </table> <p>X7R/X7E, LD series : DF≤3% Y5V:</p> <table border="1"> <thead> <tr> <th>Rated vol.</th> <th>D.F.≤</th> <th>Exception of D.F.≤</th> </tr> </thead> <tbody> <tr> <td>≥50V</td> <td>≤7.5%</td> <td>≤10%</td> <td>0603±0.1μF;0805±0.47μF;1206±4.7μF</td> </tr> <tr> <td>35V</td> <td>≤10%</td> <td>---</td> <td>---</td> </tr> <tr> <td rowspan="2">25V</td> <td rowspan="2">≤7.5%</td> <td>≤10%</td> <td>0402±0.047μF;0603±0.1μF;0805±0.33μF;1206±1μF; 1210±4.7μF</td> </tr> <tr> <td>≤15%</td> <td>0402±0.068μF;0603±0.47μF;1206±4.7μF; 1210±22μF; TT series &amp; Cap≥1μF</td> </tr> <tr> <td>16V(C&lt;1.0μF)</td> <td>≤10%</td> <td>≤12.5%</td> <td>0402±0.068μF; 0603±0.68μF</td> </tr> <tr> <td></td> <td></td> <td>≤20%</td> <td>0402±0.22μF</td> </tr> <tr> <td>16V(C≥1.0μF)</td> <td>≤12.5%</td> <td>≤20%</td> <td>0603±2.2μF;0805±3.3μF;1206±10μF;1210±22μF; 1812±47μF; TT series &amp; Cap≥1μF</td> </tr> <tr> <td>10V</td> <td>≤20%</td> <td>≤30%</td> <td>0402±0.47μF</td> </tr> <tr> <td>6.3V</td> <td>≤30%</td> <td>---</td> <td>---</td> </tr> </tbody> </table> <p>*I.R.: ≥10V, 1GΩ or 50 Ω-F whichever is smaller. Class II (X7R, X7E, X6S, X5R, Y5V)</p> <table border="1"> <thead> <tr> <th>Rated voltage</th> <th>Insulation Resistance</th> </tr> </thead> <tbody> <tr> <td>100V: X7R</td> <td rowspan="6">1GΩ or RxC≥10 Ω-F whichever is smaller.</td> </tr> <tr> <td>50V:0603±1μF;0805±1μF;1206±2.2μF;1210±4.7μF</td> </tr> <tr> <td>35V:0805±2.2μF;1210±10μF</td> </tr> <tr> <td>25V:0402±1μF;0603±2.2μF;0805±2.2μF;1206±10μF;1210±10μF</td> </tr> <tr> <td>16V:0201±0.1μF;0402±0.22μF;0603±1μF;0805±2.2μF;1206±10μF;1210±47μF</td> </tr> <tr> <td>10V:0201±47nF;0402±0.47μF;0603±0.47μF; 0805±2.2μF;1206±4.7μF;1210±47μF 6.3V ; 4V ; TT series</td> </tr> </tbody> </table>	Rated vol.	D.F.≤	Exception of D.F.≤	≥100V	≤3%	≤6%	1206±0.47μF	≤7.5%	0805±0.1μF; 0603±0.068μF	≥50V	≤3%	≤6%	0201(50V);0603±0.047μF; 0805±0.18μF; 1206±0.47μF	≤10%	1210±4.7μF	≤20%	0402±0.1μF;0603±1μF; 0805±1μF; 1206±2.2μF; 1210±10μF; TT series	35V	≤5%	≤20%	0603±1μF; 0805±2.2μF; 1210±10μF	25V	≤5%	≤10%	0201±0.01μF;0805±1μF; 1210±10μF	≤14%	0603±0.33μF;1206±4.7μF	≤15%	0402±0.10μF;0603±0.47μF;0805±2.2μF;1206±6.8μF; 1210±22μF; TT series	≤20%	0402±1μF	16V	≤5%	≤10%	0603±0.15μF;0805±0.68μF;1206±2.2μF;1210±4.7μF	≤15%	0201±0.01μF;0402±0.033μF;0603±0.68μF;0805±2.2μF;1206±4.7μF; 1210±22μF; TT series	10V	≤7.5%	≤15%	0201±0.012μF;0402±0.33μF; 0603±0.33μF;0805±2.2μF 1206±2.2μF; 1210±22μF	≤20%	0201±0.1μF ;0402±1μF; TT series	6.3V	≤15%	≤30%	0201±0.1μF;0402±1μF;0603±10μF; 0805±4.7μF;1206±47μF;1210±100μF;TT series	4V	≤20%	---	---	Rated vol.	D.F.≤	Exception of D.F.≤	≥50V	≤7.5%	≤10%	0603±0.1μF;0805±0.47μF;1206±4.7μF	35V	≤10%	---	---	25V	≤7.5%	≤10%	0402±0.047μF;0603±0.1μF;0805±0.33μF;1206±1μF; 1210±4.7μF	≤15%	0402±0.068μF;0603±0.47μF;1206±4.7μF; 1210±22μF; TT series & Cap≥1μF	16V(C<1.0μF)	≤10%	≤12.5%	0402±0.068μF; 0603±0.68μF			≤20%	0402±0.22μF	16V(C≥1.0μF)	≤12.5%	≤20%	0603±2.2μF;0805±3.3μF;1206±10μF;1210±22μF; 1812±47μF; TT series & Cap≥1μF	10V	≤20%	≤30%	0402±0.47μF	6.3V	≤30%	---	---	Rated voltage	Insulation Resistance	100V: X7R	1GΩ or RxC≥10 Ω-F whichever is smaller.	50V:0603±1μF;0805±1μF;1206±2.2μF;1210±4.7μF	35V:0805±2.2μF;1210±10μF	25V:0402±1μF;0603±2.2μF;0805±2.2μF;1206±10μF;1210±10μF	16V:0201±0.1μF;0402±0.22μF;0603±1μF;0805±2.2μF;1206±10μF;1210±47μF	10V:0201±47nF;0402±0.47μF;0603±0.47μF; 0805±2.2μF;1206±4.7μF;1210±47μF 6.3V ; 4V ; TT series
Rated vol.	D.F.≤	Exception of D.F.≤																																																																																																		
≥100V	≤3%	≤6%	1206±0.47μF																																																																																																	
		≤7.5%	0805±0.1μF; 0603±0.068μF																																																																																																	
≥50V	≤3%	≤6%	0201(50V);0603±0.047μF; 0805±0.18μF; 1206±0.47μF																																																																																																	
		≤10%	1210±4.7μF																																																																																																	
		≤20%	0402±0.1μF;0603±1μF; 0805±1μF; 1206±2.2μF; 1210±10μF; TT series																																																																																																	
35V	≤5%	≤20%	0603±1μF; 0805±2.2μF; 1210±10μF																																																																																																	
25V	≤5%	≤10%	0201±0.01μF;0805±1μF; 1210±10μF																																																																																																	
		≤14%	0603±0.33μF;1206±4.7μF																																																																																																	
		≤15%	0402±0.10μF;0603±0.47μF;0805±2.2μF;1206±6.8μF; 1210±22μF; TT series																																																																																																	
		≤20%	0402±1μF																																																																																																	
16V	≤5%	≤10%	0603±0.15μF;0805±0.68μF;1206±2.2μF;1210±4.7μF																																																																																																	
		≤15%	0201±0.01μF;0402±0.033μF;0603±0.68μF;0805±2.2μF;1206±4.7μF; 1210±22μF; TT series																																																																																																	
10V	≤7.5%	≤15%	0201±0.012μF;0402±0.33μF; 0603±0.33μF;0805±2.2μF 1206±2.2μF; 1210±22μF																																																																																																	
		≤20%	0201±0.1μF ;0402±1μF; TT series																																																																																																	
6.3V	≤15%	≤30%	0201±0.1μF;0402±1μF;0603±10μF; 0805±4.7μF;1206±47μF;1210±100μF;TT series																																																																																																	
4V	≤20%	---	---																																																																																																	
Rated vol.	D.F.≤	Exception of D.F.≤																																																																																																		
≥50V	≤7.5%	≤10%	0603±0.1μF;0805±0.47μF;1206±4.7μF																																																																																																	
35V	≤10%	---	---																																																																																																	
25V	≤7.5%	≤10%	0402±0.047μF;0603±0.1μF;0805±0.33μF;1206±1μF; 1210±4.7μF																																																																																																	
		≤15%	0402±0.068μF;0603±0.47μF;1206±4.7μF; 1210±22μF; TT series & Cap≥1μF																																																																																																	
16V(C<1.0μF)	≤10%	≤12.5%	0402±0.068μF; 0603±0.68μF																																																																																																	
		≤20%	0402±0.22μF																																																																																																	
16V(C≥1.0μF)	≤12.5%	≤20%	0603±2.2μF;0805±3.3μF;1206±10μF;1210±22μF; 1812±47μF; TT series & Cap≥1μF																																																																																																	
10V	≤20%	≤30%	0402±0.47μF																																																																																																	
6.3V	≤30%	---	---																																																																																																	
Rated voltage	Insulation Resistance																																																																																																			
100V: X7R	1GΩ or RxC≥10 Ω-F whichever is smaller.																																																																																																			
50V:0603±1μF;0805±1μF;1206±2.2μF;1210±4.7μF																																																																																																				
35V:0805±2.2μF;1210±10μF																																																																																																				
25V:0402±1μF;0603±2.2μF;0805±2.2μF;1206±10μF;1210±10μF																																																																																																				
16V:0201±0.1μF;0402±0.22μF;0603±1μF;0805±2.2μF;1206±10μF;1210±47μF																																																																																																				
10V:0201±47nF;0402±0.47μF;0603±0.47μF; 0805±2.2μF;1206±4.7μF;1210±47μF 6.3V ; 4V ; TT series																																																																																																				

# Appendix I : Reliability Test Conditions and Requirements

No	Item	Test Condition	Requirements																																																																																																																																																							
14.	Humidity (Damp Heat) Load	<p>* Test temp.: 40±2°C                      * Humidity: 90~95%RH                      * Test time: 500+24/-0 hrs.                      * To apply voltage:                      Rated voltage.(Max.500V)                      * Before initial measurement(Class II only): To apply test voltage for 1hr at 40°C and then set for 24±2 hrs at room temp.                      * Measurement to be made after keeping at room temp. for 24±2 hrs.</p>	<p>* No remarkable damage.                      Cap change: NP0: ±7.5% or 0.75pF whichever is larger.                      X7R, X7E, X6S, X5R: ≥10V**, within ±12.5%; 6.3V within ±25%; TT series, within ±25%                      **10V:0603≥4.7µF;0402≥1µF;0201≥0.1µF, within ±25%;                      Y5V: ≥10V, within ±30%; 6.3V, within +30/-40%                      Q/D.F. value: NP0: C≥30pF,Q≥200;C&lt;30pF, Q≥100+10/3C                      X7R, X6S, X5R:</p> <table border="1"> <thead> <tr> <th>Rated vol.</th> <th>D.F.≤</th> <th>Exception of D.F. ≤</th> </tr> </thead> <tbody> <tr> <td rowspan="2">≥100V</td> <td rowspan="2">≤3%</td> <td>≤6% 1206±0.47µF</td> </tr> <tr> <td>≤7.5% 0805±0.1µF; 0603±0.068µF</td> </tr> <tr> <td rowspan="3">≥50V</td> <td rowspan="3">≤3%</td> <td>≤6% 0201(50V);0603±0.047µF; 0805±0.18µF; 1206±0.47µF</td> </tr> <tr> <td>≤10% 1210±4.7µF</td> </tr> <tr> <td>≤20% 0402±0.1µF;0603±1µF; 0805±1µF;1206±2.2µF; 1210±10µF; TT series</td> </tr> <tr> <td rowspan="4">35V</td> <td rowspan="4">≤5%</td> <td>≤20% 0603±1µF; 0805±2.2µF;1210±10µF</td> </tr> <tr> <td>≤10% 0201±0.01µF;0805±1µF; 1210±10µF</td> </tr> <tr> <td>≤14% 0603±0.33µF;1206±4.7µF</td> </tr> <tr> <td>≤15% 0402±0.10µF;0603±0.47µF;0805±2.2µF;1206±6.8µF;1210±22µF; TT series</td> </tr> <tr> <td rowspan="2">25V</td> <td rowspan="2">≤5%</td> <td>≤20% 0402±1µF</td> </tr> <tr> <td>≤10% 0603±0.15µF;0805±0.68µF;1206±2.2µF;1210±4.7µF</td> </tr> <tr> <td rowspan="2">16V</td> <td rowspan="2">≤5%</td> <td>≤15% 0201±0.01µF;0402±0.033µF;0603±0.68µF;0805±2.2µF; 1206±4.7µF; 1210±22µF; TT series</td> </tr> <tr> <td>≤15% 0201±0.012µF; 0402±0.33µF; 0603±0.33µF;0805±2.2µF;1206±2.2µF; 1210±22µF</td> </tr> <tr> <td>10V</td> <td>≤7.5%</td> <td>≤20% 0201±0.1µF ;0402±1µF; TT series</td> </tr> <tr> <td>6.3V</td> <td>≤15%</td> <td>≤30% 0201±0.1µF;0402±1µF;0603±10µF; 0805±4.7µF;1206±4.7µF;1210±100µF;TT series</td> </tr> <tr> <td>4V</td> <td>≤20%</td> <td>---</td> </tr> </tbody> </table> <p>X7R/X7E, LD series : DF≤3%                      Y5V:</p> <table border="1"> <thead> <tr> <th>Rated vol.</th> <th>D.F.≤</th> <th>Exception of D.F.≤</th> </tr> </thead> <tbody> <tr> <td>≥50V</td> <td>≤7.5%</td> <td>≤10% 0603±0.1µF; 0805±0.47µF;1206±4.7µF; TT series &amp; Cap≥1µF</td> </tr> <tr> <td>35V</td> <td>≤10%</td> <td>---</td> </tr> <tr> <td>25V</td> <td>≤7.5%</td> <td>≤10% 0402±0.047µF;0603±0.1µF;0805±0.33µF;1206±1µF; 1210±4.7µF</td> </tr> <tr> <td rowspan="2">16V (C&lt;1.0µF)</td> <td rowspan="2">≤10%</td> <td>≤15% 0402±0.068µF;0603±0.47µF;1206±4.7µF;1210±22µF; TT series &amp; Cap≥1µF</td> </tr> <tr> <td>≤20% 0402±0.22µF</td> </tr> <tr> <td>16V (C≥1.0µF)</td> <td>≤12.5%</td> <td>≤20% 0603±2.2µF;0805±3.3µF;1206±10µF;1210±22µF;1812±47µF; TT series &amp; Cap≥1µF</td> </tr> <tr> <td>10V</td> <td>≤20%</td> <td>≤30% 0402±0.47µF</td> </tr> <tr> <td>6.3V</td> <td>≤30%</td> <td>---</td> </tr> </tbody> </table> <p>*I.R.: ≥10V, 500MΩ or 25 Q-F whichever is smaller.                      Class II (X7R, X7E, X6S, X5R, Y5V)</p> <table border="1"> <thead> <tr> <th>Rated voltage</th> <th>Insulation Resistance</th> </tr> </thead> <tbody> <tr> <td>100V: X7R</td> <td rowspan="10">500MΩ or RxCa5 Q-F whichever is smaller.</td> </tr> <tr> <td>50V:0603±1µF;0805±1µF;1206±2.2µF;1210±4.7µF</td> </tr> <tr> <td>35V:0805±2.2µF;1210±10µF</td> </tr> <tr> <td>25V:0402±1µF;0603±2.2µF;0805±2.2µF;1206±10µF;1210±10µF</td> </tr> <tr> <td>16V:0201±0.1µF;0402±0.22µF;0603±1µF;0805±2.2µF;1206±10µF;1210±47µF</td> </tr> <tr> <td>10V:0201±47nF;0402±0.47µF;0603±0.47µF</td> </tr> <tr> <td>0805±2.2µF;1206±4.7µF;1210±47µF</td> </tr> <tr> <td>6.3V : 4V : TT series</td> </tr> </tbody> </table>	Rated vol.	D.F.≤	Exception of D.F. ≤	≥100V	≤3%	≤6% 1206±0.47µF	≤7.5% 0805±0.1µF; 0603±0.068µF	≥50V	≤3%	≤6% 0201(50V);0603±0.047µF; 0805±0.18µF; 1206±0.47µF	≤10% 1210±4.7µF	≤20% 0402±0.1µF;0603±1µF; 0805±1µF;1206±2.2µF; 1210±10µF; TT series	35V	≤5%	≤20% 0603±1µF; 0805±2.2µF;1210±10µF	≤10% 0201±0.01µF;0805±1µF; 1210±10µF	≤14% 0603±0.33µF;1206±4.7µF	≤15% 0402±0.10µF;0603±0.47µF;0805±2.2µF;1206±6.8µF;1210±22µF; TT series	25V	≤5%	≤20% 0402±1µF	≤10% 0603±0.15µF;0805±0.68µF;1206±2.2µF;1210±4.7µF	16V	≤5%	≤15% 0201±0.01µF;0402±0.033µF;0603±0.68µF;0805±2.2µF; 1206±4.7µF; 1210±22µF; TT series	≤15% 0201±0.012µF; 0402±0.33µF; 0603±0.33µF;0805±2.2µF;1206±2.2µF; 1210±22µF	10V	≤7.5%	≤20% 0201±0.1µF ;0402±1µF; TT series	6.3V	≤15%	≤30% 0201±0.1µF;0402±1µF;0603±10µF; 0805±4.7µF;1206±4.7µF;1210±100µF;TT series	4V	≤20%	---	Rated vol.	D.F.≤	Exception of D.F.≤	≥50V	≤7.5%	≤10% 0603±0.1µF; 0805±0.47µF;1206±4.7µF; TT series & Cap≥1µF	35V	≤10%	---	25V	≤7.5%	≤10% 0402±0.047µF;0603±0.1µF;0805±0.33µF;1206±1µF; 1210±4.7µF	16V (C<1.0µF)	≤10%	≤15% 0402±0.068µF;0603±0.47µF;1206±4.7µF;1210±22µF; TT series & Cap≥1µF	≤20% 0402±0.22µF	16V (C≥1.0µF)	≤12.5%	≤20% 0603±2.2µF;0805±3.3µF;1206±10µF;1210±22µF;1812±47µF; TT series & Cap≥1µF	10V	≤20%	≤30% 0402±0.47µF	6.3V	≤30%	---	Rated voltage	Insulation Resistance	100V: X7R	500MΩ or RxCa5 Q-F whichever is smaller.	50V:0603±1µF;0805±1µF;1206±2.2µF;1210±4.7µF	35V:0805±2.2µF;1210±10µF	25V:0402±1µF;0603±2.2µF;0805±2.2µF;1206±10µF;1210±10µF	16V:0201±0.1µF;0402±0.22µF;0603±1µF;0805±2.2µF;1206±10µF;1210±47µF	10V:0201±47nF;0402±0.47µF;0603±0.47µF	0805±2.2µF;1206±4.7µF;1210±47µF	6.3V : 4V : TT series																																																																																
Rated vol.	D.F.≤	Exception of D.F. ≤																																																																																																																																																								
≥100V	≤3%	≤6% 1206±0.47µF																																																																																																																																																								
		≤7.5% 0805±0.1µF; 0603±0.068µF																																																																																																																																																								
≥50V	≤3%	≤6% 0201(50V);0603±0.047µF; 0805±0.18µF; 1206±0.47µF																																																																																																																																																								
		≤10% 1210±4.7µF																																																																																																																																																								
		≤20% 0402±0.1µF;0603±1µF; 0805±1µF;1206±2.2µF; 1210±10µF; TT series																																																																																																																																																								
35V	≤5%	≤20% 0603±1µF; 0805±2.2µF;1210±10µF																																																																																																																																																								
		≤10% 0201±0.01µF;0805±1µF; 1210±10µF																																																																																																																																																								
		≤14% 0603±0.33µF;1206±4.7µF																																																																																																																																																								
		≤15% 0402±0.10µF;0603±0.47µF;0805±2.2µF;1206±6.8µF;1210±22µF; TT series																																																																																																																																																								
25V	≤5%	≤20% 0402±1µF																																																																																																																																																								
		≤10% 0603±0.15µF;0805±0.68µF;1206±2.2µF;1210±4.7µF																																																																																																																																																								
16V	≤5%	≤15% 0201±0.01µF;0402±0.033µF;0603±0.68µF;0805±2.2µF; 1206±4.7µF; 1210±22µF; TT series																																																																																																																																																								
		≤15% 0201±0.012µF; 0402±0.33µF; 0603±0.33µF;0805±2.2µF;1206±2.2µF; 1210±22µF																																																																																																																																																								
10V	≤7.5%	≤20% 0201±0.1µF ;0402±1µF; TT series																																																																																																																																																								
6.3V	≤15%	≤30% 0201±0.1µF;0402±1µF;0603±10µF; 0805±4.7µF;1206±4.7µF;1210±100µF;TT series																																																																																																																																																								
4V	≤20%	---																																																																																																																																																								
Rated vol.	D.F.≤	Exception of D.F.≤																																																																																																																																																								
≥50V	≤7.5%	≤10% 0603±0.1µF; 0805±0.47µF;1206±4.7µF; TT series & Cap≥1µF																																																																																																																																																								
35V	≤10%	---																																																																																																																																																								
25V	≤7.5%	≤10% 0402±0.047µF;0603±0.1µF;0805±0.33µF;1206±1µF; 1210±4.7µF																																																																																																																																																								
16V (C<1.0µF)	≤10%	≤15% 0402±0.068µF;0603±0.47µF;1206±4.7µF;1210±22µF; TT series & Cap≥1µF																																																																																																																																																								
		≤20% 0402±0.22µF																																																																																																																																																								
16V (C≥1.0µF)	≤12.5%	≤20% 0603±2.2µF;0805±3.3µF;1206±10µF;1210±22µF;1812±47µF; TT series & Cap≥1µF																																																																																																																																																								
10V	≤20%	≤30% 0402±0.47µF																																																																																																																																																								
6.3V	≤30%	---																																																																																																																																																								
Rated voltage	Insulation Resistance																																																																																																																																																									
100V: X7R	500MΩ or RxCa5 Q-F whichever is smaller.																																																																																																																																																									
50V:0603±1µF;0805±1µF;1206±2.2µF;1210±4.7µF																																																																																																																																																										
35V:0805±2.2µF;1210±10µF																																																																																																																																																										
25V:0402±1µF;0603±2.2µF;0805±2.2µF;1206±10µF;1210±10µF																																																																																																																																																										
16V:0201±0.1µF;0402±0.22µF;0603±1µF;0805±2.2µF;1206±10µF;1210±47µF																																																																																																																																																										
10V:0201±47nF;0402±0.47µF;0603±0.47µF																																																																																																																																																										
0805±2.2µF;1206±4.7µF;1210±47µF																																																																																																																																																										
6.3V : 4V : TT series																																																																																																																																																										
15.		High Temperature Load (Endurance)	<p>*Test temp.:                      NP0, X7R/X7E: 125±3°C                      X6S: 105±3°C                      X5R, Y5V: 85±3°C                      *Test time: 1000+24/-0 hrs.                      *To apply voltage:                      (1) 6.3V or C≥10µF or TT series:                      150% of rated voltage.                      (2) 10V≥Ur&lt;500V:                      200% of rated voltage.                      (3) 500V: 150% of rated voltage.                      (4) Ur≥630V:                      120% of rated voltage.                      (5) 100% of rated voltage for below range.</p> <table border="1"> <thead> <tr> <th>Size</th> <th>Dielectric</th> <th>Rated voltage</th> <th>Capacitance range</th> </tr> </thead> <tbody> <tr> <td rowspan="2">0201</td> <td rowspan="2">X7R/ X6S/ X5R</td> <td>6.3V,10V</td> <td>C≥0.1µF</td> </tr> <tr> <td>6.3V,10V</td> <td>C≥1.0µF</td> </tr> <tr> <td rowspan="2">0402</td> <td rowspan="2">X7R/ X6S/ X5R</td> <td>4V</td> <td>C≥22µF</td> </tr> <tr> <td>6.3V,10V</td> <td>C≥4.7µF</td> </tr> <tr> <td rowspan="2">0603</td> <td rowspan="2">X7R/ X6S/ X5R</td> <td>35V</td> <td>C≥1.0µF</td> </tr> <tr> <td>4V</td> <td>C≥47µF</td> </tr> <tr> <td rowspan="2">0805</td> <td rowspan="2">X7R/ X6S/ X5R</td> <td>6.3V</td> <td>C≥22µF</td> </tr> <tr> <td>6.3V</td> <td>C≥47µF</td> </tr> <tr> <td>1206</td> <td>NP0</td> <td>3000V</td> <td>C≥1.5pF</td> </tr> <tr> <td>TT18</td> <td>Y5V</td> <td>6.3V,10V</td> <td>C≥2.2µF</td> </tr> <tr> <td>TT21</td> <td>Y5V</td> <td>6.3V</td> <td>C≥10µF</td> </tr> <tr> <td>TT31</td> <td>Y5V</td> <td>6.3V</td> <td>C≥22µF</td> </tr> </tbody> </table> <p>(6)150% of rated voltage for below range.</p> <table border="1"> <thead> <tr> <th>Size</th> <th>Dielectric</th> <th>Rated voltage</th> <th>Capacitance</th> </tr> </thead> <tbody> <tr> <td rowspan="2">0201</td> <td rowspan="2">X5R/X7R/X6S</td> <td>16V</td> <td>C≥0.1µF</td> </tr> <tr> <td>50V</td> <td>C≥0.1µF</td> </tr> <tr> <td rowspan="2">0402</td> <td rowspan="2">X5R/X7R/X6S</td> <td>10~25V</td> <td>C≥0.22µF</td> </tr> <tr> <td>16V</td> <td>C≥0.47µF</td> </tr> <tr> <td rowspan="2">0603</td> <td rowspan="2">X5R/X7R/</td> <td>10~50V</td> <td>C≥1.0µF</td> </tr> <tr> <td>16V</td> <td>C≥2.2µF</td> </tr> <tr> <td rowspan="3">0805</td> <td rowspan="3">X5R/X7R/</td> <td>10~50V</td> <td>C≥4.7µF</td> </tr> <tr> <td>50V</td> <td>C≥2.2µF</td> </tr> <tr> <td>100V</td> <td>C≥0.47µF</td> </tr> <tr> <td rowspan="2">2220</td> <td rowspan="2">X7R</td> <td>16V</td> <td>C≥4.7µF</td> </tr> <tr> <td>100V</td> <td>C≥6.8µF</td> </tr> </tbody> </table> <p>*Before initial measurement (Class II only): To apply test voltage for 1hr at test temp. and then set for 24±2 hrs at room temp.                      *Measurement to be made after keeping at room temp. for 24±2 hrs</p>	Size	Dielectric	Rated voltage	Capacitance range	0201	X7R/ X6S/ X5R	6.3V,10V	C≥0.1µF	6.3V,10V	C≥1.0µF	0402	X7R/ X6S/ X5R	4V	C≥22µF	6.3V,10V	C≥4.7µF	0603	X7R/ X6S/ X5R	35V	C≥1.0µF	4V	C≥47µF	0805	X7R/ X6S/ X5R	6.3V	C≥22µF	6.3V	C≥47µF	1206	NP0	3000V	C≥1.5pF	TT18	Y5V	6.3V,10V	C≥2.2µF	TT21	Y5V	6.3V	C≥10µF	TT31	Y5V	6.3V	C≥22µF	Size	Dielectric	Rated voltage	Capacitance	0201	X5R/X7R/X6S	16V	C≥0.1µF	50V	C≥0.1µF	0402	X5R/X7R/X6S	10~25V	C≥0.22µF	16V	C≥0.47µF	0603	X5R/X7R/	10~50V	C≥1.0µF	16V	C≥2.2µF	0805	X5R/X7R/	10~50V	C≥4.7µF	50V	C≥2.2µF	100V	C≥0.47µF	2220	X7R	16V	C≥4.7µF	100V	C≥6.8µF	<p>* No remarkable damage. Cap change: NP0: ±3.0% or ±0.3pF whichever is larger                      X7R, X7E, X6S, X5R: ≥10V**, within ±12.5%; 6.3V within ±25%; TT series, within ±25%                      **10V:0603≥4.7µF;0402≥1µF;0201≥0.1µF, within ±25%;                      Y5V: ≥10V, within ±30%; 6.3V, within +30/-40%                      Q/D.F. value: NP0: More than 30pF, Q≥350; 10pF≤C&lt;30pF, Q≥275+2.5C; Less than 10pF, Q≥200+10C                      X7R, X6S, X5R:</p> <table border="1"> <thead> <tr> <th>Rated vol.</th> <th>D.F.≤</th> <th>Exception of D.F. ≤</th> </tr> </thead> <tbody> <tr> <td rowspan="2">≥100V</td> <td rowspan="2">≤3%</td> <td>≤6% 1206±0.47µF</td> </tr> <tr> <td>≤7.5% 0805±0.1µF, 0603±0.068µF</td> </tr> <tr> <td rowspan="3">≥50V</td> <td rowspan="3">≤3%</td> <td>≤6% 0201(50V);0603±0.047µF; 0805±0.18µF; 1206±0.47µF</td> </tr> <tr> <td>≤10% 1210±4.7µF</td> </tr> <tr> <td>≤20% 0402±0.1µF;0603±1µF; 0805±1µF;1206±2.2µF; 1210±10µF; TT series</td> </tr> <tr> <td rowspan="4">35V</td> <td rowspan="4">≤5%</td> <td>≤20% 0603±1µF; 0805±2.2µF;1210±10µF</td> </tr> <tr> <td>≤10% 0201±0.01µF;0805±1µF; 1210±10µF</td> </tr> <tr> <td>≤14% 0603±0.33µF;1206±4.7µF</td> </tr> <tr> <td>≤15% 0402±0.10µF;0603±0.47µF;0805±2.2µF;1206±6.8µF;1210±22µF; TT series</td> </tr> <tr> <td rowspan="2">25V</td> <td rowspan="2">≤5%</td> <td>≤20% 0402±1µF</td> </tr> <tr> <td>≤10% 0603±0.15µF;0805±0.68µF;1206±2.2µF;1210±4.7µF</td> </tr> <tr> <td rowspan="2">16V</td> <td rowspan="2">≤5%</td> <td>≤15% 0201±0.01µF;0402±0.033µF;0603±0.68µF;0805±2.2µF; 1206±4.7µF; 1210±22µF; TT series</td> </tr> <tr> <td>≤15% 0201±0.012µF; 0402±0.33µF; 0603±0.33µF;0805±2.2µF;1206±2.2µF; 1210±22µF</td> </tr> <tr> <td>10V</td> <td>≤7.5%</td> <td>≤20% 0201±0.1µF ;0402±1µF; TT series</td> </tr> <tr> <td>6.3V</td> <td>≤15%</td> <td>≤30% 0201±0.1µF;0402±1µF;0603±10µF; 0805±4.7µF;1206±4.7µF;1210±100µF;TT series</td> </tr> <tr> <td>4V</td> <td>≤20%</td> <td>---</td> </tr> </tbody> </table> <p>X7R/X7E, LD series : DF≤3%                      Y5V:</p> <table border="1"> <thead> <tr> <th>Rated vol.</th> <th>D.F.≤</th> <th>Exception of D.F.≤</th> </tr> </thead> <tbody> <tr> <td>≥50V</td> <td>≤7.5%</td> <td>≤10% 0603±0.1µF; 0805±0.47µF;1206±4.7µF; TT series &amp; Cap≥1µF</td> </tr> <tr> <td>35V</td> <td>≤10%</td> <td>---</td> </tr> <tr> <td>25V</td> <td>≤7.5%</td> <td>≤10% 0402±0.047µF;0603±0.1µF;0805±0.33µF;1206±1µF; 1210±4.7µF</td> </tr> <tr> <td rowspan="2">16V(C&lt;1.0µF)</td> <td rowspan="2">≤10%</td> <td>≤15% 0402±0.068µF;0603±0.47µF;1206±4.7µF;1210±22µF; TT series &amp; Cap≥1µF</td> </tr> <tr> <td>≤20% 0402±0.22µF</td> </tr> <tr> <td>16V(C≥1.0µF)</td> <td>≤12.5%</td> <td>≤20% 0603±2.2µF;0805±3.3µF;1206±10µF;1210±22µF;1812±47µF;TT series &amp; Cap≥1µF</td> </tr> <tr> <td>10V</td> <td>≤20%</td> <td>≤30% 0402±0.47µF</td> </tr> <tr> <td>6.3V</td> <td>≤30%</td> <td>---</td> </tr> </tbody> </table> <p>*I.R.: ≥10V, 1GΩ or 50 Q-F whichever is smaller.                      Class II (X7R, X7E, X6S, X5R, Y5V)</p> <table border="1"> <thead> <tr> <th>Rated voltage</th> <th>Insulation Resistance</th> </tr> </thead> <tbody> <tr> <td>100V: X7R</td> <td rowspan="10">1GΩ or RxC≥10 Q-F whichever is smaller.</td> </tr> <tr> <td>50V:0603±1µF;0805±1µF;1206±2.2µF;1210±4.7µF</td> </tr> <tr> <td>35V:0805±2.2µF;1210±10µF</td> </tr> <tr> <td>25V:0402±1µF;0603±2.2µF;0805±2.2µF;1206±10µF;1210±10µF</td> </tr> <tr> <td>16V:0201±0.1µF;0402±0.22µF;0603±1µF;0805±2.2µF;1206±10µF;1210±47µF</td> </tr> <tr> <td>10V:0201±47nF;0402±0.47µF;0603±0.47µF;0805±2.2µF; 1206±4.7µF;1210±47µF</td> </tr> <tr> <td>6.3V : 4V : TT series</td> </tr> </tbody> </table>	Rated vol.	D.F.≤	Exception of D.F. ≤	≥100V	≤3%	≤6% 1206±0.47µF	≤7.5% 0805±0.1µF, 0603±0.068µF	≥50V	≤3%	≤6% 0201(50V);0603±0.047µF; 0805±0.18µF; 1206±0.47µF	≤10% 1210±4.7µF	≤20% 0402±0.1µF;0603±1µF; 0805±1µF;1206±2.2µF; 1210±10µF; TT series	35V	≤5%	≤20% 0603±1µF; 0805±2.2µF;1210±10µF	≤10% 0201±0.01µF;0805±1µF; 1210±10µF	≤14% 0603±0.33µF;1206±4.7µF	≤15% 0402±0.10µF;0603±0.47µF;0805±2.2µF;1206±6.8µF;1210±22µF; TT series	25V	≤5%	≤20% 0402±1µF	≤10% 0603±0.15µF;0805±0.68µF;1206±2.2µF;1210±4.7µF	16V	≤5%	≤15% 0201±0.01µF;0402±0.033µF;0603±0.68µF;0805±2.2µF; 1206±4.7µF; 1210±22µF; TT series	≤15% 0201±0.012µF; 0402±0.33µF; 0603±0.33µF;0805±2.2µF;1206±2.2µF; 1210±22µF	10V	≤7.5%	≤20% 0201±0.1µF ;0402±1µF; TT series	6.3V	≤15%	≤30% 0201±0.1µF;0402±1µF;0603±10µF; 0805±4.7µF;1206±4.7µF;1210±100µF;TT series	4V	≤20%	---	Rated vol.	D.F.≤	Exception of D.F.≤	≥50V	≤7.5%	≤10% 0603±0.1µF; 0805±0.47µF;1206±4.7µF; TT series & Cap≥1µF	35V	≤10%	---	25V	≤7.5%	≤10% 0402±0.047µF;0603±0.1µF;0805±0.33µF;1206±1µF; 1210±4.7µF	16V(C<1.0µF)	≤10%	≤15% 0402±0.068µF;0603±0.47µF;1206±4.7µF;1210±22µF; TT series & Cap≥1µF	≤20% 0402±0.22µF	16V(C≥1.0µF)	≤12.5%	≤20% 0603±2.2µF;0805±3.3µF;1206±10µF;1210±22µF;1812±47µF;TT series & Cap≥1µF	10V	≤20%	≤30% 0402±0.47µF	6.3V	≤30%	---	Rated voltage	Insulation Resistance	100V: X7R	1GΩ or RxC≥10 Q-F whichever is smaller.	50V:0603±1µF;0805±1µF;1206±2.2µF;1210±4.7µF	35V:0805±2.2µF;1210±10µF	25V:0402±1µF;0603±2.2µF;0805±2.2µF;1206±10µF;1210±10µF	16V:0201±0.1µF;0402±0.22µF;0603±1µF;0805±2.2µF;1206±10µF;1210±47µF	10V:0201±47nF;0402±0.47µF;0603±0.47µF;0805±2.2µF; 1206±4.7µF;1210±47µF	6.3V : 4V : TT series
Size		Dielectric	Rated voltage	Capacitance range																																																																																																																																																						
0201	X7R/ X6S/ X5R	6.3V,10V	C≥0.1µF																																																																																																																																																							
		6.3V,10V	C≥1.0µF																																																																																																																																																							
0402	X7R/ X6S/ X5R	4V	C≥22µF																																																																																																																																																							
		6.3V,10V	C≥4.7µF																																																																																																																																																							
0603	X7R/ X6S/ X5R	35V	C≥1.0µF																																																																																																																																																							
		4V	C≥47µF																																																																																																																																																							
0805	X7R/ X6S/ X5R	6.3V	C≥22µF																																																																																																																																																							
		6.3V	C≥47µF																																																																																																																																																							
1206	NP0	3000V	C≥1.5pF																																																																																																																																																							
TT18	Y5V	6.3V,10V	C≥2.2µF																																																																																																																																																							
TT21	Y5V	6.3V	C≥10µF																																																																																																																																																							
TT31	Y5V	6.3V	C≥22µF																																																																																																																																																							
Size	Dielectric	Rated voltage	Capacitance																																																																																																																																																							
0201	X5R/X7R/X6S	16V	C≥0.1µF																																																																																																																																																							
		50V	C≥0.1µF																																																																																																																																																							
0402	X5R/X7R/X6S	10~25V	C≥0.22µF																																																																																																																																																							
		16V	C≥0.47µF																																																																																																																																																							
0603	X5R/X7R/	10~50V	C≥1.0µF																																																																																																																																																							
		16V	C≥2.2µF																																																																																																																																																							
0805	X5R/X7R/	10~50V	C≥4.7µF																																																																																																																																																							
		50V	C≥2.2µF																																																																																																																																																							
		100V	C≥0.47µF																																																																																																																																																							
2220	X7R	16V	C≥4.7µF																																																																																																																																																							
		100V	C≥6.8µF																																																																																																																																																							
Rated vol.	D.F.≤	Exception of D.F. ≤																																																																																																																																																								
≥100V	≤3%	≤6% 1206±0.47µF																																																																																																																																																								
		≤7.5% 0805±0.1µF, 0603±0.068µF																																																																																																																																																								
≥50V	≤3%	≤6% 0201(50V);0603±0.047µF; 0805±0.18µF; 1206±0.47µF																																																																																																																																																								
		≤10% 1210±4.7µF																																																																																																																																																								
		≤20% 0402±0.1µF;0603±1µF; 0805±1µF;1206±2.2µF; 1210±10µF; TT series																																																																																																																																																								
35V	≤5%	≤20% 0603±1µF; 0805±2.2µF;1210±10µF																																																																																																																																																								
		≤10% 0201±0.01µF;0805±1µF; 1210±10µF																																																																																																																																																								
		≤14% 0603±0.33µF;1206±4.7µF																																																																																																																																																								
		≤15% 0402±0.10µF;0603±0.47µF;0805±2.2µF;1206±6.8µF;1210±22µF; TT series																																																																																																																																																								
25V	≤5%	≤20% 0402±1µF																																																																																																																																																								
		≤10% 0603±0.15µF;0805±0.68µF;1206±2.2µF;1210±4.7µF																																																																																																																																																								
16V	≤5%	≤15% 0201±0.01µF;0402±0.033µF;0603±0.68µF;0805±2.2µF; 1206±4.7µF; 1210±22µF; TT series																																																																																																																																																								
		≤15% 0201±0.012µF; 0402±0.33µF; 0603±0.33µF;0805±2.2µF;1206±2.2µF; 1210±22µF																																																																																																																																																								
10V	≤7.5%	≤20% 0201±0.1µF ;0402±1µF; TT series																																																																																																																																																								
6.3V	≤15%	≤30% 0201±0.1µF;0402±1µF;0603±10µF; 0805±4.7µF;1206±4.7µF;1210±100µF;TT series																																																																																																																																																								
4V	≤20%	---																																																																																																																																																								
Rated vol.	D.F.≤	Exception of D.F.≤																																																																																																																																																								
≥50V	≤7.5%	≤10% 0603±0.1µF; 0805±0.47µF;1206±4.7µF; TT series & Cap≥1µF																																																																																																																																																								
35V	≤10%	---																																																																																																																																																								
25V	≤7.5%	≤10% 0402±0.047µF;0603±0.1µF;0805±0.33µF;1206±1µF; 1210±4.7µF																																																																																																																																																								
16V(C<1.0µF)	≤10%	≤15% 0402±0.068µF;0603±0.47µF;1206±4.7µF;1210±22µF; TT series & Cap≥1µF																																																																																																																																																								
		≤20% 0402±0.22µF																																																																																																																																																								
16V(C≥1.0µF)	≤12.5%	≤20% 0603±2.2µF;0805±3.3µF;1206±10µF;1210±22µF;1812±47µF;TT series & Cap≥1µF																																																																																																																																																								
10V	≤20%	≤30% 0402±0.47µF																																																																																																																																																								
6.3V	≤30%	---																																																																																																																																																								
Rated voltage	Insulation Resistance																																																																																																																																																									
100V: X7R	1GΩ or RxC≥10 Q-F whichever is smaller.																																																																																																																																																									
50V:0603±1µF;0805±1µF;1206±2.2µF;1210±4.7µF																																																																																																																																																										
35V:0805±2.2µF;1210±10µF																																																																																																																																																										
25V:0402±1µF;0603±2.2µF;0805±2.2µF;1206±10µF;1210±10µF																																																																																																																																																										
16V:0201±0.1µF;0402±0.22µF;0603±1µF;0805±2.2µF;1206±10µF;1210±47µF																																																																																																																																																										
10V:0201±47nF;0402±0.47µF;0603±0.47µF;0805±2.2µF; 1206±4.7µF;1210±47µF																																																																																																																																																										
6.3V : 4V : TT series																																																																																																																																																										
16.		ESR	For RF Series only, refer to data sheet.	---																																																																																																																																																						



## ■ Constructions

No.	Name	NPO	NPO/X7R/X6S/X5R/Y5V
①	Ceramic material	BaTiO3 based	
②	Inner electrode	AgPd alloy	Ni
③		Inner layer	Ag
④	Termination	Middle layer	Ni
⑤		Outer layer	Sn

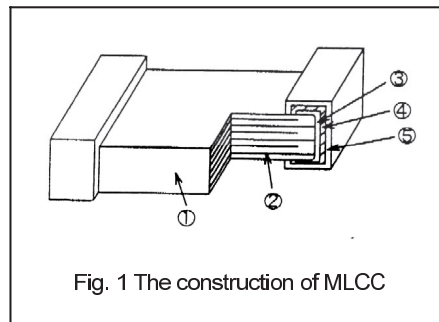

## ■ Storage and handling conditions

- (1) To store products at 5 to 40°C ambient temperature and 20 to 70% related humidity conditions.
- (2) The product is recommended to be used within one year after shipment. Check solderability in case of shelf life extension is needed.

## Cautions:

- a. The corrosive gas reacts on the terminal electrodes of capacitors, and results in the poor solderability. Do not store the capacitors in the ambience of corrosive gas (e.g., hydrogen sulfide, sulfur dioxide, chlorine, ammonia gas etc.)
- b. In corrosive atmosphere, solderability might be degraded, and silver migration might occur to cause low reliability.
- c. Due to the dewing by rapid humidity change, or the photochemical change of the terminal electrode by direct sunlight, the solderability and electrical performance may deteriorate. Do not store capacitors under direct sunlight or dewing condition. To store products on the shelf and avoid exposure to moisture.

## ■ Recommended soldering conditions

The lead-free termination MLCCs are not only to be used on SMT against lead-free solder paste, but also suitable against lead-containing solder paste. If the optimized solder joint is requested, increasing soldering time, temperature and concentration of N2 within oven are recommended.

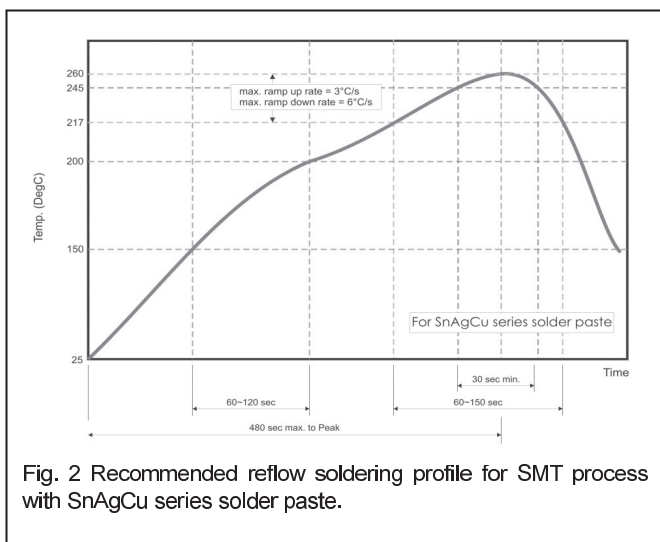

Fig. 2 Recommended reflow soldering profile for SMT process with SnAgCu series solder paste.

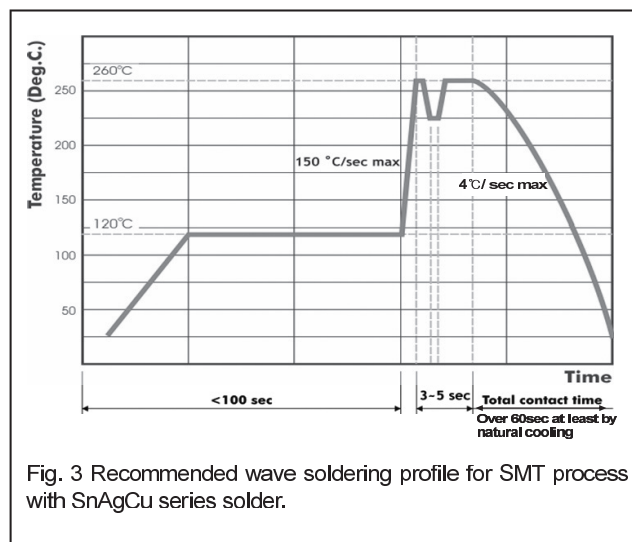

Fig. 3 Recommended wave soldering profile for SMT process with SnAgCu series solder.

A series of horizontal dashed lines for writing.

**Taiwan - Yang-Mei Plant / Sales Office**

Walsin Technology Corporation  
566-1, Kao-Shi Road, Yang-Mei,  
Tao-Yuan, Taiwan  
Tel: +886-3-475-8711  
Fax: +886-3-475-7130  
Email: [info@passivecomponent.com](mailto:info@passivecomponent.com)

**Taiwan - Kaohsiung Plant**

Walsin Technology Corporation  
1st, West 13 Street, K.E.P.Z.  
Kaohsiung, Taiwan  
Tel: +886-7-821-8171  
Fax: +886-7-813-1661  
Email: [info@passivecomponent.com](mailto:info@passivecomponent.com)

**China - Dalang Plant / Sales Office**

Dongguan Walsin Tech. Electronics CO., Ltd.  
Xiniupo Administrative Zone,  
Dalang Town, Dongguan City,  
Guangdong Province 523799  
Tel: +86-769-831-15168  
Fax: +86-769-831-15188  
Email: [stlin@passivecomponent.com](mailto:stlin@passivecomponent.com)

**China - Suzhou Plant / Sales Office**

Suzhou Walsin Technology Electronics Co., Ltd.  
No. 369, Changyan Street,  
Suzhou Industrial Park,  
Jiangsu Province 215126  
Tel: +86-512-628-36888  
Fax: +86-512-628-37888  
Email: [davidcheng@passivecomponent.com](mailto:davidcheng@passivecomponent.com)

**China - Guangzhou Plant / Sales Office**

Pan Overseas (Guangzhou) Electronic Co., Ltd.  
No. 277, Hong Ming Road, Eastern Section,  
Guangzhou Economic and Technology  
Development Zone, China  
Tel: +86-20-8223-7476  
Fax: +86-20-8223-7475  
Email: [info@passivecomponent.com](mailto:info@passivecomponent.com)

**China - Chongqing Sales Office**

Avenue of Stars Yongchuan District No.999  
Chongqing , China  
Tel: +86-512-628-36888 Ext:5329  
Fax: +86-512-628-37888  
Email: [tommylee@passivecomponent.com](mailto:tommylee@passivecomponent.com)

**Germany - Munich Sales Office**

Walsin Technology Corporation Europe  
Stefan-George-Ring 29, 81929 Munich, Germany  
Tel: +49-(0)89-9308-6475  
Fax: +49-(0)89-9308-6464  
Email: [aw@passivecomponent.com](mailto:aw@passivecomponent.com)

**Singapore - Sales Office**

WTC Singapore Sales Office, Singapore  
8 Ubi View #04-01 Serial System Building  
Singapore 408554  
Tel: +65-6896-3877  
Fax: +65-6861-3381  
Email: [michaelchee@sg.passivecomponent.com](mailto:michaelchee@sg.passivecomponent.com)

**United States - West Coast Sales Office**

Walsin Technology Corporation, USA  
39500 Stevenson Place Suite 101,  
Fremont, CA 94539, USA  
Tel: +1-214-708-5182  
E-mail: [fctseng@passivecomponent.com](mailto:fctseng@passivecomponent.com)

**JAPAN - Sales Office**

WTC Japan Sales Office, Japan  
8-4-17, Fukayanaka, Ayase-shi,  
Kanagawa, 252-1107, Japan.  
Tel: +81-467-71-0884  
Fax: +81-467-71-0910  
Email: [tsakano@kamaya.co.jp](mailto:tsakano@kamaya.co.jp)



Walsin Technology Corporation

**TAIWAN - WTC Yang-Mei Plant / Sales Office**

Walsin Technology Corporation

566-1, Kao-Shi Road, Yang-Mei, Tao-Yuan, Taiwan

Tel: +886-3-475-8711

Fax: +886-3-475-7130

Email: [info@passivecomponent.com](mailto:info@passivecomponent.com)

**Kaohsiung Plant, Taiwan**

Walsin Technology Corporation

1st, West 13 Street, K.E.P.Z. Kaohsiung, Taiwan

Tel: +886-7-821-8171

Fax: +886-7-813-1661

Email: [info@passivecomponent.com](mailto:info@passivecomponent.com)



**Jan 2014**