

OMNIMATE Signal - series BL/SL 5.08 SLDF 5.08 L/F 6 SN OR BX

Weidmüller Interface GmbH & Co. KG
Klingenbergstraße 16
D-32758 Detmold
Germany
Fon: +49 5231 14-0
Fax: +49 5231 14-292083
www.weidmueller.com

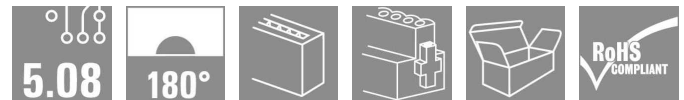
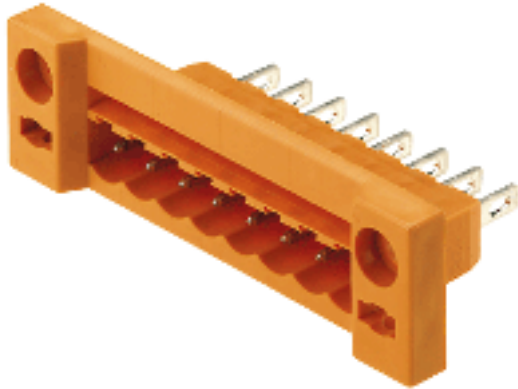

Male connector for through-panel mounting with optional locking function. Internal connection as flat-blade or solder connection. These male connectors provide space for labelling and can be coded.

- 400 V (IEC) / 300 V (UL)
- 15 A (IEC) / 10 A (UL)

General ordering data

Type	SLDF 5.08 L/F 6 SN OR BX
Order No.	1599170000
Version	PCB plug-in connector, male header, 5.08 mm, No. of poles: 6, 180°, Flat-blade connection, Solder connection, Box
GTIN (EAN)	4008190179595
Qty.	50 pc(s).
Product data	IEC: 400 V / 15 A UL: 300 V / 10 A
Packaging	Box

Creation date December 8, 2013 9:32:17 PM CET

**OMNIMATE Signal - series BL/SL 5.08
SLDF 5.08 L/F 6 SN OR BX**

Weidmüller Interface GmbH & Co. KG
Klingenbergstraße 16
D-32758 Detmold
Germany
Fon: +49 5231 14-0
Fax: +49 5231 14-292083
www.weidmueller.com

Technical data
Dimensions and weights

Net weight 7.86 g

System parameters

Product family	OMNIMATE Signal - series BL/SL 5.08	Wire connection method	Flat-blade connection, Solder connection
Conductor outlet direction	180°	Pitch in mm (P)	5.08 mm
Pitch in inches (P)	0.2 inch	No. of poles	6
L1 in mm	25.4 mm	L1 in inches	1 inch

Material data

Insulating material	PBT	Colour	Orange
Colour chart (similar)	RAL 2000	UL 94 flammability rating	V-0
CTI	≥ 200	Contact material	CuSn
Contact surface	tinned		

DIN IEC rating data

Rated current, min. no. of poles (TU=20°C)	15 A	Rated current, number of poles (Tu=40°C), min	13 A
Rated voltage for surge voltage class pollution degree II/2	400 V	Rated voltage for surge voltage class pollution degree III/2	320 V
Rated voltage for surge voltage class pollution degree III/3	250 V	Rated impulse voltage for surge voltage class pollution degree II/2	4 kV
Rated impulse voltage for surge voltage class pollution degree III/2	4 kV	Rated impulse voltage for surge voltage class contamination degree III/3	4 kV

CSA rating data

Institute (CSA)		Rated voltage (Use group B)	300 V
Rated current (use group B)	10 A	Rated voltage (use group D)	300 V
Rated current (use group D)	10 A		

UL 1059 rating data

Institute (UR)		Rated voltage (use group B)	300 V
Rated current (use group B)	10 A	Rated voltage (use group D)	300 V
Rated current (use group D)	10 A		

Classifications

ETIM 3.0	EC001284	UNSPSC	30-21-18-10
eClass 5.1	27-26-07-04	eClass 6.2	27-26-07-04
eClass 7.1	27-44-04-02		

Data sheet**OMNIMATE Signal - series BL/SL 5.08
SLDF 5.08 L/F 6 SN OR BX**

Weidmüller Interface GmbH & Co. KG
Klingenbergstraße 16
D-32758 Detmold
Germany
Fon: +49 5231 14-0
Fax: +49 5231 14-292083
www.weidmueller.com

Technical data**Notes**

Notes

- Additional colours on request
- Rated current related to rated cross-section & min. No. of poles.
- Connectable cables with solder connection solid and flexible up to 2.5 mm² with insulating/shrink-wrap sleeve or from 2.8 mm flat blade receptacles with insulated sleeves acc. to DIN IEC 760
- P on drawing = pitch
- Rated data refer only to the component itself. Clearance and creepage distances to other components are to be designed in accordance with the relevant application standards.

Approvals

Approvals



ROHS

Conform

Data sheet

**OMNIMATE Signal - series BL/SL 5.08
SLDF 5.08 L/F 6 SN OR BX**

Weidmüller Interface GmbH & Co. KG
 Klingenbergstraße 16
 D-32758 Detmold
 Germany
 Fon: +49 5231 14-0
 Fax: +49 5231 14-292083
 www.weidmueller.com

Drawings

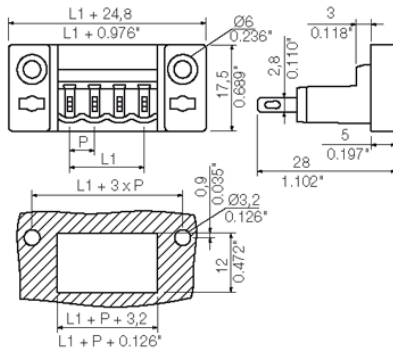

**OMNIMATE Signal - series BL/SL 5.08
SLDF 5.08 L/F 6 SN OR BX**

Weidmüller Interface GmbH & Co. KG
Klingenbergstraße 16
D-32758 Detmold
Germany
Fon: +49 5231 14-0
Fax: +49 5231 14-292083
www.weidmueller.com

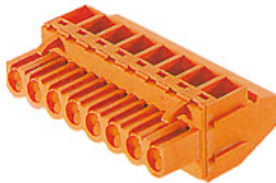
Mating connector (conditionally pluggable)
BLZ 5.08/90B

Female plugs with clamping-yoke screw connection. The female plugs provide space for labelling and can be coded.

- 0.2 - 2.5 mm² (IEC) / 26 - 12 AWG (UL)
- 400 V (IEC) / 300 V (UL)
- 15 A (IEC) / 10 A (UL)

General ordering data

Type	Order No.	Version	GTIN (EAN)	Qty.	Product data	Packaging
BLZ 5.08/06/90B SN OR BX	1555460000	PCB plug-in connector, female plug, 5.08 mm, No. of poles: 6, 90°, Clamping yoke connection, Clamping range, rated connection, max.: 3.31 mm ² , Box	4008190012830	54 pc(s).	IEC: 400 V / 15 A / 0.2 - 2.5 mm ² UL: 300 V / 10 A / AWG 26 - AWG 12	Box

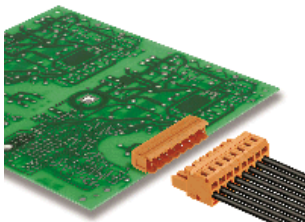
BLZF 5.08/180B

Female plugs with tension-clamp wire connection system, straight 180° outlet direction. The female plugs provide space for labelling and can be coded.

- 0.2 - 2.5 mm² (IEC) / 26 - 12 AWG (UL)
- 400 V (IEC) / 300 V (UL)
- 17 A (IEC) / 15 A (UL)

General ordering data

Type	Order No.	Version	GTIN (EAN)	Qty.	Product data	Packaging
BLZF 5.08/06/180B SN OR BX	1708340000	PCB plug-in connector, female plug, 5.08 mm, No. of poles: 6, 180°, Tension clamp connection, Clamping range, rated connection, max.: 3.31 mm ² , Box	4008190317805	54 pc(s).	IEC: 400 V / 17 A / 0.2 - 2.5 mm ² UL: 300 V / 15 A / AWG 26 - AWG 12	Box

**OMNIMATE Signal - series BL/SL 5.08
SLDF 5.08 L/F 6 SN OR BX**

Weidmüller Interface GmbH & Co. KG
Klingenbergstraße 16
D-32758 Detmold
Germany
Fon: +49 5231 14-0
Fax: +49 5231 14-292083
www.weidmueller.com

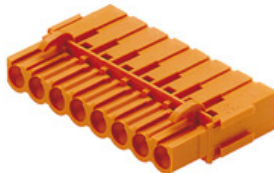
Mating connector (conditionally pluggable)
BLC 5.08BR

Female plugs with crimp wire connection system. The female plugs provide space for labelling and can be coded.

- 0.25 - 2.5 mm² (IEC) / 26 - 14 AWG (UL)
- 400 V (IEC) / 300 V (UL)
- 21 A (IEC) / 10 A (UL)

General ordering data

Type	Order No.	Version	GTIN (EAN)	Qty.	Product data	Packaging
BLC 5.08/06/180BR BK BX	1712150000	PCB plug-in connector, female plug, 5.08 mm, No. of poles: 6, 180°, Crimp connection, Clamping range, rated connection, max.: 2.5 mm ² , Box	4008190935160	50 pc(s).	IEC: 400 V / 21 A UL: 300 V / 10 A / AWG 26 - AWG 14	Box
BLC 5.08/06/180BR OR BX	1649410000	PCB plug-in connector, female plug, 5.08 mm, No. of poles: 6, 180°, Crimp connection, Clamping range, rated connection, max.: 2.5 mm ² , Box	4008190294526	50 pc(s).	IEC: 400 V / 21 A UL: 300 V / 10 A / AWG 26 - AWG 14	Box

BLZF 5.08/90B

Female plugs with tension-clamp wire connection system. The female plugs provide space for labelling and can be coded.

- 0.2 - 2.5 mm² (IEC) / 26 - 12 AWG (UL)
- 400 V (IEC) / 300 V (UL)
- 16.5 A (IEC) / 10 A (UL)

General ordering data

Type	Order No.	Version	GTIN (EAN)	Qty.	Product data	Packaging
BLZF 5.08/06/90B SN BK BX	1671520000	PCB plug-in connector, female plug, 5.08 mm, No. of poles: 6, 90°, Tension clamp connection, Clamping range, rated connection, max.: 3.31 mm ² , Box	4008190433222	54 pc(s).	IEC: 400 V / 16.5 A / 0.2 - 2.5 mm ² UL: 300 V / 10 A / AWG 26 - AWG 12	Box
BLZF 5.08/06/90B SN OR BX	1671290000	PCB plug-in connector, female plug, 5.08 mm, No. of poles: 6, 90°, Tension clamp connection, Clamping range, rated	4008190432997	54 pc(s).	IEC: 400 V / 16.5 A / 0.2 - 2.5 mm ² UL: 300 V / 10 A / AWG 26 - AWG 12	Box

**OMNIMATE Signal - series BL/SL 5.08
SLDF 5.08 L/F 6 SN OR BX**

Weidmüller Interface GmbH & Co. KG
Klingenbergstraße 16
D-32758 Detmold
Germany
Fon: +49 5231 14-0
Fax: +49 5231 14-292083
www.weidmueller.com

Mating connector (conditionally pluggable)

connection, max.: 3.31
mm², Box

BLZ 5.08/270B

Female plugs with clamping-yoke screw connection. The female plugs provide space for labelling and can be coded.

- 0.2 - 2.5 mm² (IEC) / 26 - 12 AWG (UL)
- 400 V (IEC) / 300 V (UL)
- 15 A (IEC) / 10 A (UL)

General ordering data

Type	Order No.	Version	GTIN (EAN)	Qty.	Product data	Packaging
BLZ 5.08/06/270B SN BK BX	1560010000	PCB plug-in connector, female plug, 5.08 mm, No. of poles: 6, 270°, Clamping yoke connection, Clamping range, rated connection, max.: 3.31 mm ² , Box	4008190269692	54 pc(s).	IEC: 400 V / 15 A / 0.2 - 2.5 mm ² UL: 300 V / 10 A / AWG 26 - AWG 12	Box
BLZ 5.08/06/270B SN OR BX	1560060000	PCB plug-in connector, female plug, 5.08 mm, No. of poles: 6, 270°, Clamping yoke connection, Clamping range, rated connection, max.: 3.31 mm ² , Box	4008190069650	54 pc(s).	IEC: 400 V / 15 A / 0.2 - 2.5 mm ² UL: 300 V / 10 A / AWG 26 - AWG 12	Box

BLZF 5.08/270B

Female plugs with tension-clamp wire connection system. The female plugs provide space for labelling and can be coded.

- 0.2 - 2.5 mm² (IEC) / 26 - 12 AWG (UL)
- 400 V (IEC) / 300 V (UL)
- 16.5 A (IEC) / 10 A (UL)

General ordering data

Type	Order No.	Version	GTIN (EAN)	Qty.	Product data	Packaging
BLZF 5.08/06/270B SN BK BX	1672670000	PCB plug-in connector, female plug, 5.08 mm, No. of poles: 6, 270°, Tension clamp connection, Clamping range, rated connection, max.: 3.31 mm ² , Box	4008190434380	54 pc(s).	IEC: 400 V / 16.5 A / 0.2 - 2.5 mm ² UL: 300 V / 10 A / AWG 26 - AWG 12	Box

OMNIMATE Signal - series BL/SL 5.08 SLDF 5.08 L/F 6 SN OR BX

Weidmüller Interface GmbH & Co. KG
 Klingenbergstraße 16
 D-32758 Detmold
 Germany
 Fon: +49 5231 14-0
 Fax: +49 5231 14-292083
 www.weidmueller.com

Mating connector (conditionally pluggable)

BLZF 5.08/06/270B SN OR BX	1672440000	PCB plug-in connector, female plug, 5.08 mm, No. of poles: 6, 270°, Tension clamp connection, Clamping range, rated connection, max.: 3.31 mm ² , Box	400819043415154 pc(s).	IEC: 400 V / 16.5 A / 0.2 - 2.5 mm ² UL: 300 V / 10 A / AWG 26 - AWG 12	Box
----------------------------------	----------------------------	--	------------------------	---	-----

BLL 5.08/180B



Female header for PCB mounting. The solder pin length is optimised for wave flow soldering.

- 400 V (IEC) / 300 V (UL)
- 23 A (IEC) / 15 A (UL)

General ordering data

Type	Order No.	Version	GTIN (EAN)	Qty.	Product data	Packaging
BLL 5.08/06/180B 3.2SN OR BX	1682770000	PCB plug-in connector, female header, Dovetails for fixing blocks, Solder connection, 5.08 mm, No. of poles: 6, 180°, Solder pin length (l): 3.2 mm, tinned, Orange, Box	400819047453954 pc(s).		IEC: 400 V / 23 A UL: 300 V / 15 A	Box

ZZ_Varianten



Female plugs with clamping-yoke screw for wire connection with straight (180°) outlet direction. The female plugs provide space for labelling and can be coded.

- 0.2 - 2.5 mm² (IEC) / 26 - 12 AWG (UL)
- 400 V (IEC) / 300 V (UL)
- 19 A (IEC) / 15 A (UL)

General ordering data

Type	Order No.	Version	GTIN (EAN)	Qty.	Product data	Packaging
BLZ 5.08/06/180B SN DKGX BX	1529150000	PCB plug-in connector, female plug, 5.08 mm, No. of poles: 6, 180°, Clamping yoke connection, Clamping range, rated connection, max.: 3.31 mm ² , Box	400819029022150 pc(s).		IEC: 400 V / 19 A / 0.2 - 2.5 mm ² UL: 300 V / 15 A / AWG 26 - AWG 12	Box

**OMNIMATE Signal - series BL/SL 5.08
SLDF 5.08 L/F 6 SN OR BX**

Weidmüller Interface GmbH & Co. KG
Klingenbergstraße 16
D-32758 Detmold
Germany
Fon: +49 5231 14-0
Fax: +49 5231 14-292083
www.weidmueller.com

Mating connector (conditionally pluggable)
BLDT 5.08B

Female plugs with two clamping-yoke screw connections per pole for wire connections with 90° and 270° outlet directions. The female plugs provide space for labelling and can be coded.

- 0.2 - 2.5 mm² (IEC) / 26 - 12 AWG (UL)
- 400 V (IEC) / 300 V (UL)
- 14 A (IEC) / 10 A (UL)

General ordering data

Type	Order No.	Version	GTIN (EAN)	Qty.	Product data	Packaging
BLDT 5.08/06/-B SN OR BX	1651780000	PCB plug-in connector, female plug, 5.08 mm, No. of poles: 6, 180°, TOP connection, Clamping range, rated connection, max.: 3.31 mm ² , Box	4008190400460	50 pc(s).	IEC: 400 V / 14 A / 0.2 - 2.5 mm ² UL: 300 V / 10 A / AWG 26 - AWG 12	Box
BLDT 5.08/06/-B SN BK BX	1673820000	PCB plug-in connector, female plug, 5.08 mm, No. of poles: 6, 180°, TOP connection, Clamping range, rated connection, max.: 3.31 mm ² , Box	4008190435554	50 pc(s).	IEC: 400 V / 14 A / 0.2 - 2.5 mm ² UL: 300 V / 10 A / AWG 26 - AWG 12	Box

BLZ 5.08/180B

Female plugs with clamping-yoke screw for wire connection with straight (180°) outlet direction. The female plugs provide space for labelling and can be coded.

- 0.2 - 2.5 mm² (IEC) / 26 - 12 AWG (UL)
- 400 V (IEC) / 300 V (UL)
- 19 A (IEC) / 15 A (UL)

General ordering data

Type	Order No.	Version	GTIN (EAN)	Qty.	Product data	Packaging
BLZ 5.08/06/180B SN OR BX	1529160000	PCB plug-in connector, female plug, 5.08 mm, No. of poles: 6, 180°, Clamping yoke connection, Clamping range, rated connection, max.: 3.31 mm ² , Box	4008190127954	50 pc(s).	IEC: 400 V / 19 A / 0.2 - 2.5 mm ² UL: 300 V / 15 A / AWG 26 - AWG 12	Box
BLZ 5.08/06/180B SN BK BX	1529110000	PCB plug-in connector, female plug, 5.08 mm, No. of poles: 6, 180°, Clamping yoke connection, Clamping	4008190053642	50 pc(s).	IEC: 400 V / 19 A / 0.2 - 2.5 mm ² UL: 300 V / 15 A / AWG 26 - AWG 12	Box

**OMNIMATE Signal - series BL/SL 5.08
SLDF 5.08 L/F 6 SN OR BX**

Weidmüller Interface GmbH & Co. KG
Klingenbergstraße 16
D-32758 Detmold
Germany
Fon: +49 5231 14-0
Fax: +49 5231 14-292083
www.weidmueller.com

Mating connector (conditionally pluggable)

range, rated connection,
max.: 3.31 mm², Box

BLIDC 5.08B

Female plugs with IDC wire connection system. The female plugs provide space for labelling and can be coded.

- 0.35 - 0.75 mm² (IEC) / 22 - 20 AWG (UL)
- 400 V (IEC) / 300 V (UL)
- 11 A (IEC) / 5 A (UL)

General ordering data

Type	Order No.	Version	GTIN (EAN)	Qty.	Product data	Packaging
BLIDC 5.08/06/180B SN OR BX	1759540000	PCB plug-in connector, female plug, 5.08 mm, No. of poles: 6, 180°, IDC terminal, Clamping range, rated connection, max.: 0.75 mm ² , Box	4032248069774	50 pc(s).	IEC: 400 V / 11 A / 0.5 - 0.75 mm ² UL: 300 V / 5 A / AWG 22 - AWG 20	Box
BLIDC 5.08/06/180B SN BK BX	1759650000	PCB plug-in connector, female plug, 5.08 mm, No. of poles: 6, 180°, IDC terminal, Clamping range, rated connection, max.: 0.75 mm ² , Box	4032248069880	50 pc(s).	IEC: 400 V / 11 A / 0.5 - 0.75 mm ² UL: 300 V / 5 A / AWG 22 - AWG 20	Box

BLZP 5.08/225B SN

Clamping-yoke wire connection with right-angled (90° or 270°) or angled (225°) outlet direction. The female plugs provide space for labelling and can be coded. Can be fastened with flange or release latch. They also feature the integrated plus/minus screw, protection from under insertion of wire, and are delivered with open clamping yoke.

- 0.2 - 2.5 mm² (IEC) / 26-12 AWG (UL)
- 400 V (IEC) / 300 V (UL)
- 17.5 A (IEC) / 10 A (UL)

General ordering data

Type	Order No.	Version	GTIN (EAN)	Qty.	Product data	Packaging
BLZP 5.08HC/06/225B SN OR BX	1945790000	PCB plug-in connector, female plug, 5.08 mm, No. of poles: 6, 225°, Clamping yoke connection, Clamping range, rated connection, max.: 4 mm ² , Box	4032248621262	54 pc(s).	IEC: 400 V / 17.5 A / 0.2 - 4 mm ² UL: 300 V / 15 A / AWG 30 - AWG 12	Box

**OMNIMATE Signal - series BL/SL 5.08
SLDF 5.08 L/F 6 SN OR BX**

Weidmüller Interface GmbH & Co. KG
Klingenbergstraße 16
D-32758 Detmold
Germany
Fon: +49 5231 14-0
Fax: +49 5231 14-292083
www.weidmueller.com

Mating connector (conditionally pluggable)

BLZP 5.08HC/06/225B SN BK BX	1946020000	PCB plug-in connector, female plug, 5.08 mm, No. of poles: 6, 225°, Clamping yoke connection, Clamping range, rated connection, max.: 4 mm ² , Box	4032248621552 54 pc(s).	IEC: 400 V / 17.5 A / 0.2 - 4 mm ² UL: 300 V / 15 A / AWG 30 - AWG 12	Box
------------------------------------	----------------------------	--	-------------------------	---	-----

BLZ 5.08/225B

Female plugs with clamping-yoke screw for wire connection with 225° outlet direction. The female plugs provide space for labelling and can be coded.

- 0.2 - 2.5 mm² (IEC) / 26 - 12 AWG (UL)
- 400 V (IEC) / 300 V (UL)
- 16.5 A (IEC) / 10 A (UL)

General ordering data

Type	Order No.	Version	GTIN (EAN)	Qty.	Product data	Packaging
BLZ 5.08/06/225B SN OR BX	1742140000	PCB plug-in connector, female plug, 5.08 mm, No. of poles: 6, 225°, Clamping yoke connection, Clamping range, rated connection, max.: 3.31 mm ² , Box	4008190247126 54 pc(s).		IEC: 400 V / 16.5 A / 0.2 - 2.5 mm ² UL: 300 V / 10 A / AWG 26 - AWG 12	Box
BLZ 5.08/06/225B SN BK BX	1742370000	PCB plug-in connector, female plug, 5.08 mm, No. of poles: 6, 225°, Clamping yoke connection, Clamping range, rated connection, max.: 3.31 mm ² , Box	4032248049806 54 pc(s).		IEC: 400 V / 16.5 A / 0.2 - 2.5 mm ² UL: 300 V / 10 A / AWG 26 - AWG 12	Box

**OMNIMATE Signal - series BL/SL 5.08
SLDF 5.08 L/F 6 SN OR BX**

Weidmüller Interface GmbH & Co. KG
Klingenbergstraße 16
D-32758 Detmold
Germany
Fon: +49 5231 14-0
Fax: +49 5231 14-292083
www.weidmueller.com

Mating connector (fully pluggable)
BLZF 5.08/270

Female plugs with tension-clamp wire connection system. The female plugs provide space for labelling and can be coded.

- 0.2 - 2.5 mm² (IEC) / 26 - 12 AWG (UL)
- 400 V (IEC) / 300 V (UL)
- 16.5 A (IEC) / 10 A (UL)

General ordering data

Type	Order No.	Version	GTIN (EAN)	Qty.	Product data	Packaging
BLZF 5.08/06/270 SN OR BX	1671980000	PCB plug-in connector, female plug, 5.08 mm, No. of poles: 6, 270°, Tension clamp connection, Clamping range, rated connection, max.: 3.31 mm ² , Box	4008190433697	60 pc(s).	IEC: 400 V / 16.5 A / 0.2 - 2.5 mm ² UL: 300 V / 10 A / AWG 26 - AWG 12	Box
BLZF 5.08/06/270 SN BK BX	1672210000	PCB plug-in connector, female plug, 5.08 mm, No. of poles: 6, 270°, Tension clamp connection, Clamping range, rated connection, max.: 3.31 mm ² , Box	4008190433925	60 pc(s).	IEC: 400 V / 16.5 A / 0.2 - 2.5 mm ² UL: 300 V / 10 A / AWG 26 - AWG 12	Box

BLZ 5.08/180

Female plugs with clamping-yoke screw for wire connection with straight (180°) outlet direction. The female plugs provide space for labelling and can be coded.

- 0.2 - 2.5 mm² (IEC) / 26 - 12 AWG (UL)
- 400 V (IEC) / 300 V (UL)
- 19 A (IEC) / 15 A (UL)

General ordering data

Type	Order No.	Version	GTIN (EAN)	Qty.	Product data	Packaging
BLZ 5.08/06/180 SN BK BX	1526810000	PCB plug-in connector, female plug, 5.08 mm, No. of poles: 6, 180°, Clamping yoke connection, Clamping range, rated connection, max.: 3.31 mm ² , Box	4008190163891	50 pc(s).	IEC: 400 V / 19 A / 0.2 - 2.5 mm ² UL: 300 V / 15 A / AWG 26 - AWG 12	Box
BLZ 5.08/06/180 SN OR BX	1526860000	PCB plug-in connector, female plug, 5.08 mm, No. of poles: 6, 180°, Clamping yoke connection, Clamping	4008190039448	50 pc(s).	IEC: 400 V / 19 A / 0.2 - 2.5 mm ² UL: 300 V / 15 A / AWG 26 - AWG 12	Box

**OMNIMATE Signal - series BL/SL 5.08
SLDF 5.08 L/F 6 SN OR BX**

Weidmüller Interface GmbH & Co. KG
Klingenbergstraße 16
D-32758 Detmold
Germany
Fon: +49 5231 14-0
Fax: +49 5231 14-292083
www.weidmueller.com

Mating connector (fully pluggable)

range, rated connection,
max.: 3.31 mm², Box

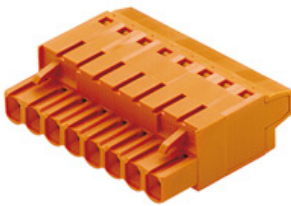
BLT 5.08

Female plugs with TOP screw system for connecting wires with straight 180° outlet direction. The female plugs provide space for labelling and can be coded.

- 0.2 - 2.5 mm² (IEC) / 26 - 14 AWG (UL)
- 400 V (IEC) / 300 V (UL)
- 17 A (IEC) / 10 A (UL)

General ordering data

Type	Order No.	Version	GTIN (EAN)	Qty.	Product data	Packaging
BLT 5.08HC/06/180 SN BK BX	1499910000	PCB plug-in connector, female plug, 5.08 mm, No. of poles: 6, 180°, TOP connection, Clamping range, rated connection, max.: 2.5 mm ² , Box	4008190279363	60 pc(s).	IEC: 400 V / 17 A / 0.2 - 2.5 mm ² UL: 300 V / 13 A / AWG 26 - AWG 14	Box
BLT 5.08HC/06/180 SN OR BX	1499960000	PCB plug-in connector, female plug, 5.08 mm, No. of poles: 6, 180°, TOP connection, Clamping range, rated connection, max.: 2.5 mm ² , Box	4008190140953	60 pc(s).	IEC: 400 V / 17 A / 0.2 - 2.5 mm ² UL: 300 V / 13 A / AWG 26 - AWG 14	Box

BLZF 5.08/90

Female plugs with tension-clamp wire connection system. The female plugs provide space for labelling and can be coded.

- 0.2 - 2.5 mm² (IEC) / 26 - 12 AWG (UL)
- 400 V (IEC) / 300 V (UL)
- 16.5 A (IEC) / 10 A (UL)

General ordering data

Type	Order No.	Version	GTIN (EAN)	Qty.	Product data	Packaging
BLZF 5.08/06/90 SN BK BX	1671060000	PCB plug-in connector, female plug, 5.08 mm, No. of poles: 6, 90°, Tension clamp connection, Clamping range, rated connection, max.: 3.31 mm ² , Box	4008190432737	60 pc(s).	IEC: 400 V / 16.5 A / 0.2 - 2.5 mm ² UL: 300 V / 10 A / AWG 26 - AWG 12	Box

OMNIMATE Signal - series BL/SL 5.08 SLDF 5.08 L/F 6 SN OR BX

Weidmüller Interface GmbH & Co. KG
 Klingenbergstraße 16
 D-32758 Detmold
 Germany
 Fon: +49 5231 14-0
 Fax: +49 5231 14-292083
 www.weidmueller.com

Mating connector (fully pluggable)

BLZF 5.08/06/90 SN OR BX	1670830000	PCB plug-in connector, female plug, 5.08 mm, No. of poles: 6, 90°, Tension clamp connection, Clamping range, rated connection, max.: 3.31 mm ² , Box	4008190432430 60 pc(s).	IEC: 400 V / 16.5 A / 0.2 - 2.5 mm ² Box UL: 300 V / 10 A / AWG 26 - AWG 12
--------------------------------	----------------------------	---	-------------------------	---

BLZ 5.08/270



Female plugs with clamping-yoke screw connection. The female plugs provide space for labelling and can be coded.

- 0.2 - 2.5 mm² (IEC) / 26 - 12 AWG (UL)
- 400 V (IEC) / 300 V (UL)
- 15 A (IEC) / 10 A (UL)

General ordering data

Type	Order No.	Version	GTIN (EAN)	Qty.	Product data	Packaging
BLZ 5.08/06/270 SN BK BX	1557710000	PCB plug-in connector, female plug, 5.08 mm, No. of poles: 6, 270°, Clamping yoke connection, Clamping range, rated connection, max.: 3.31 mm ² , Box	4008190269463 60 pc(s).		IEC: 400 V / 15 A / 0.2 - 2.5 mm ² UL: 300 V / 10 A / AWG 26 - AWG 12	Box
BLZ 5.08/06/270 SN OR BX	1557760000	PCB plug-in connector, female plug, 5.08 mm, No. of poles: 6, 270°, Clamping yoke connection, Clamping range, rated connection, max.: 3.31 mm ² , Box	4008190145910 60 pc(s).		IEC: 400 V / 15 A / 0.2 - 2.5 mm ² UL: 300 V / 10 A / AWG 26 - AWG 12	Box

BL 5.08



Female plugs with leaf-spring wire connection system. The female plugs provide space for labelling.

- 0.2 - 1.5 mm² (IEC) / 26 - 14 AWG (UL)
- 400 V (IEC) / 300 V (UL)
- 11 A (IEC) / 10 A (UL)

General ordering data

Type	Order No.	Version	GTIN (EAN)	Qty.	Product data	Packaging
BL 5.08/06/180 SN BK BX	1716510000	PCB plug-in connector, female plug, 5.08 mm, No. of poles: 6, 180°, Pressure clamp connection,	4008190376581 50 pc(s).		IEC: 400 V / 14 A / 0.2 - 1.5 mm ² UL: 300 V / 10 A / AWG 26 - AWG 14	Box

Creation date December 8, 2013 9:32:18 PM CET

**OMNIMATE Signal - series BL/SL 5.08
SLDF 5.08 L/F 6 SN OR BX**

Weidmüller Interface GmbH & Co. KG
Klingenbergstraße 16
D-32758 Detmold
Germany
Fon: +49 5231 14-0
Fax: +49 5231 14-292083
www.weidmueller.com

Mating connector (fully pluggable)

		Clamping range, rated connection, max.: 2.08 mm ² , Box			
BL 5.08/06/180 SN OR BX	1716360000	PCB plug-in connector, female plug, 5.08 mm, No. of poles: 6, 180°, Pressure clamp connection, Clamping range, rated connection, max.: 2.08 mm ² , Box	4008190376390 50 pc(s).	IEC: 400 V / 14 A / 0.2 - 1.5 mm ² UL: 300 V / 10 A / AWG 26 - AWG 14	Box
BL 5.08/06/180 SN DKGX BX	1723870000	PCB plug-in connector, female plug, 5.08 mm, No. of poles: 6, 180°, Pressure clamp connection, Clamping range, rated connection, max.: 2.08 mm ² , Box	4008190376239 50 pc(s).	IEC: 400 V / 14 A / 0.2 - 1.5 mm ² UL: 300 V / 10 A / AWG 26 - AWG 14	Box

BLZ 5.08/90

Female plugs with clamping-yoke screw connection. The female plugs provide space for labelling and can be coded.

- 0.2 - 2.5 mm² (IEC) / 26 - 12 AWG (UL)
- 400 V (IEC) / 300 V (UL)
- 15 A (IEC) / 10 A (UL)

General ordering data

Type	Order No.	Version	GTIN (EAN)	Qty.	Product data	Packaging
BLZ 5.08/06/90 SN OR BX	1553160000	PCB plug-in connector, female plug, 5.08 mm, No. of poles: 6, 90°, Clamping yoke connection, Clamping range, rated connection, max.: 3.31 mm ² , Box	4008190075804 60 pc(s).		IEC: 400 V / 15 A / 0.2 - 2.5 mm ² UL: 300 V / 10 A / AWG 26 - AWG 12	Box
BLZ 5.08/06/90 SN BK BX	1553110000	PCB plug-in connector, female plug, 5.08 mm, No. of poles: 6, 90°, Clamping yoke connection, Clamping range, rated connection, max.: 3.31 mm ² , Box	4008190267742 60 pc(s).		IEC: 400 V / 15 A / 0.2 - 2.5 mm ² UL: 300 V / 10 A / AWG 26 - AWG 12	Box

**OMNIMATE Signal - series BL/SL 5.08
SLDF 5.08 L/F 6 SN OR BX**

Weidmüller Interface GmbH & Co. KG
Klingenbergstraße 16
D-32758 Detmold
Germany
Fon: +49 5231 14-0
Fax: +49 5231 14-292083
www.weidmueller.com

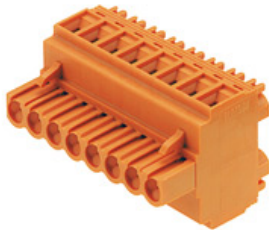
Mating connector (fully pluggable)
BLDT 5.08

Female plugs with two clamping-yoke screw connections per pole for wire connections with 90° and 270° outlet directions. The female plugs provide space for labelling and can be coded.

- 0.2 - 2.5 mm² (IEC) / 26 - 12 AWG (UL)
- 400 V (IEC) / 300 V (UL)
- 14 A (IEC) / 10 A (UL)

General ordering data

Type	Order No.	Version	GTIN (EAN)	Qty.	Product data	Packaging
BLDT 5.08/06/- SN OR BX	1644770000	PCB plug-in connector, female plug, 5.08 mm, No. of poles: 6, 180°, TOP connection, Clamping range, rated connection, max.: 3.31 mm ² , Box	4008190283988	50 pc(s).	IEC: 400 V / 14 A / 0.2 - 2.5 mm ² UL: 300 V / 10 A / AWG 26 - AWG 12	Box
BLDT 5.08/06/- SN BK BX	1660750000	PCB plug-in connector, female plug, 5.08 mm, No. of poles: 6, 180°, TOP connection, Clamping range, rated connection, max.: 3.31 mm ² , Box	4008190417208	50 pc(s).	IEC: 400 V / 14 A / 0.2 - 2.5 mm ² UL: 300 V / 10 A / AWG 26 - AWG 12	Box

BLZP 5.08/270 SN

Female plugs with clamping-yoke screw connection for wire connection and a right-angle (90° or 270°) outlet direction. The female plugs provide space for labelling and can be coded. Can be fastened with flange or release latch. They feature an integrated plus/minus screw, protection against false insertion under clamping yoke. They are delivered with an opened clamping yoke.

- 0.2 - 2.5 mm² (IEC) / 26-12 AWG (UL)
- 400 V (IEC) / 300 V (UL)
- 15 A (IEC) / 10 A (UL)

General ordering data

Type	Order No.	Version	GTIN (EAN)	Qty.	Product data	Packaging
BLZP 5.08HC/06/270 SN BK BX	1949060000	PCB plug-in connector, female plug, 5.08 mm, No. of poles: 6, 270°, Clamping yoke connection, Clamping range, rated connection, max.: 4 mm ² , Box	4032248626519	60 pc(s).	IEC: 400 V / 15.5 A / 0.2 - 4 mm ² UL: 300 V / 15 A / AWG 30 - AWG 12	Box
BLZP 5.08HC/06/270 SN OR BX	1948830000	PCB plug-in connector, female plug, 5.08 mm, No. of poles: 6, 270°, Clamping yoke connection, Clamping	4032248626281	60 pc(s).	IEC: 400 V / 15.5 A / 0.2 - 4 mm ² UL: 300 V / 15 A / AWG 30 - AWG 12	Box

OMNIMATE Signal - series BL/SL 5.08 SLDF 5.08 L/F 6 SN OR BX

Weidmüller Interface GmbH & Co. KG
 Klingenbergstraße 16
 D-32758 Detmold
 Germany
 Fon: +49 5231 14-0
 Fax: +49 5231 14-292083
 www.weidmueller.com

Mating connector (fully pluggable)

range, rated connection,
 max.: 4 mm², Box

BLZP 5.08/225 SN



Clamping-yoke wire connection with right-angled (90° or 270°) or angled (225°) outlet direction. The female plugs provide space for labelling and can be coded. Can be fastened with flange or release latch. They also feature the integrated plus/minus screw, protection from under insertion of wire, and are delivered with open clamping yoke.

- 0.2 – 2.5 mm² (IEC) / 26-12 AWG (UL)
- 400 V (IEC) / 300 V (UL)
- 17.5 A (IEC) / 10 A (UL)

General ordering data

Type	Order No.	Version	GTIN (EAN)	Qty.	Product data	Packaging
BLZP 5.08HC/06/225 SN OR BX	1946290000	PCB plug-in connector, female plug, 5.08 mm, No. of poles: 6, 225°, Clamping yoke connection, Clamping range, rated connection, max.: 4 mm ² , Box	4032248621866	60 pc(s).	IEC: 400 V / 17.5 A / 0.2 - 4 mm ² UL: 300 V / 15 A / AWG 30 - AWG 12	Box
BLZP 5.08HC/06/225 SN BK BX	1946600000	PCB plug-in connector, female plug, 5.08 mm, No. of poles: 6, 225°, Clamping yoke connection, Clamping range, rated connection, max.: 4 mm ² , Box	4032248622375	60 pc(s).	IEC: 400 V / 17.5 A / 0.2 - 4 mm ² UL: 300 V / 15 A / AWG 30 - AWG 12	Box

BLL 5.08/90



Female header for PCB mounting. The solder pin length is optimised for wave flow soldering.

- 400 V (IEC) / 300 V (UL)
- 23 A (IEC) / 15 A (UL)

General ordering data

Type	Order No.	Version	GTIN (EAN)	Qty.	Product data	Packaging
BLL 5.08/06/90 3.2 SN OR BX	1622980000	PCB plug-in connector, female header, closed side, Solder connection, 5.08 mm, No. of poles: 6, 90°, Solder pin length (l): 3.2 mm, tinned, Orange, Box	4008190279301	60 pc(s).	IEC: 400 V / 23 A UL: 300 V / 15 A	Box

**OMNIMATE Signal - series BL/SL 5.08
SLDF 5.08 L/F 6 SN OR BX**

Weidmüller Interface GmbH & Co. KG
Klingenbergstraße 16
D-32758 Detmold
Germany
Fon: +49 5231 14-0
Fax: +49 5231 14-292083
www.weidmueller.com

Mating connector (fully pluggable)
BLZF 5.08/180

Female plugs with tension-clamp wire connection system, straight 180° outlet direction. The female plugs provide space for labelling and can be coded.

- 0.2 - 2.5 mm² (IEC) / 26 - 12 AWG (UL)
- 400 V (IEC) / 300 V (UL)
- 17 A (IEC) / 15 A (UL)

General ordering data

Type	Order No.	Version	GTIN (EAN)	Qty.	Product data	Packaging
BLZF 5.08/06/180 SN OR BX	1707500000	PCB plug-in connector, female plug, 5.08 mm, No. of poles: 6, 180°, Tension clamp connection, Clamping range, rated connection, max.: 3.31 mm ² , Box	4008190395872	60 pc(s).	IEC: 400 V / 17 A / 0.2 - 2.5 mm ² UL: 300 V / 15 A / AWG 26 - AWG 12	Box
BLZF 5.08/06/180 SN BK BX	1707730000	PCB plug-in connector, female plug, 5.08 mm, No. of poles: 6, 180°, Tension clamp connection, Clamping range, rated connection, max.: 3.31 mm ² , Box	4008190316730	60 pc(s).	IEC: 400 V / 17 A / 0.2 - 2.5 mm ² UL: 300 V / 15 A / AWG 26 - AWG 12	Box

BLZ 5.08/225

Female plugs with clamping-yoke screw for wire connection with 225° outlet direction. The female plugs provide space for labelling and can be coded.

- 0.2 - 2.5 mm² (IEC) / 26 - 12 AWG (UL)
- 400 V (IEC) / 300 V (UL)
- 16.5 A (IEC) / 10 A (UL)

General ordering data

Type	Order No.	Version	GTIN (EAN)	Qty.	Product data	Packaging
BLZ 5.08/06/225 SN BK BX	1741910000	PCB plug-in connector, female plug, 5.08 mm, No. of poles: 6, 225°, Clamping yoke connection, Clamping range, rated connection, max.: 3.31 mm ² , Box	4008190255763	60 pc(s).	IEC: 400 V / 16.5 A / 0.2 - 2.5 mm ² UL: 300 V / 10 A / AWG 26 - AWG 12	Box
BLZ 5.08/06/225 SN OR BX	1741680000	PCB plug-in connector, female plug, 5.08 mm, No. of poles: 6, 225°, Clamping yoke connection, Clamping	4008190215682	60 pc(s).	IEC: 400 V / 16.5 A / 0.2 - 2.5 mm ² UL: 300 V / 10 A / AWG 26 - AWG 12	Box

**OMNIMATE Signal - series BL/SL 5.08
SLDF 5.08 L/F 6 SN OR BX**

Weidmüller Interface GmbH & Co. KG
Klingenbergstraße 16
D-32758 Detmold
Germany
Fon: +49 5231 14-0
Fax: +49 5231 14-292083
www.weidmueller.com

Mating connector (fully pluggable)

range, rated connection,
max.: 3.31 mm², Box

BLIDC 5.08

Female plugs with IDC wire connection system. The female plugs provide space for labelling and can be coded.

- 0.35 - 0.75 mm² (IEC) / 22 - 20 AWG (UL)
- 400 V (IEC) / 300 V (UL)
- 11 A (IEC) / 5 A (UL)

General ordering data

Type	Order No.	Version	GTIN (EAN)	Qty.	Product data	Packaging
BLIDC 5.08/06/180 SN OR BX	1724980000	PCB plug-in connector, female plug, 5.08 mm, No. of poles: 6, 180°, IDC terminal, Clamping range, rated connection, max.: 0.75 mm ² , Box	4008190377328	50 pc(s).	IEC: 400 V / 11 A / 0.5 - 0.75 mm ² UL: 300 V / 5 A / AWG 22 - AWG 20	Box

BLZP 5.08/180 SN

Female plugs with clamping-yoke screw for wire connection with straight (180°) outlet direction. The female plugs provide space for labelling and can be coded. Can be fastened with flange or release latch. They also feature the integrated plus/minus screw, protection from under insertion of wire, and are delivered with open clamping yoke.

- 0.2 - 2.5 mm² (IEC) / 26-12 AWG (UL)
- 400 V (IEC) / 300 V (UL)
- 19 A (IEC) / 15 A (UL)

General ordering data

Type	Order No.	Version	GTIN (EAN)	Qty.	Product data	Packaging
BLZP 5.08/06/180 SN OR BX	1943620000	PCB plug-in connector, female plug, 5.08 mm, No. of poles: 6, 180°, Clamping yoke connection, Clamping range, rated connection, max.: 4 mm ² , Box	4032248617616	45 pc(s).	IEC: 400 V / 19 A / 0.2 - 4 mm ² UL: 300 V / 15 A / AWG 30 - AWG 12	Box
BLZP 5.08/06/180 SN BK BX	1943850000	PCB plug-in connector, female plug, 5.08 mm, No. of poles: 6, 180°, Clamping yoke connection, Clamping range, rated connection, max.: 4 mm ² , Box	4032248617999	45 pc(s).	IEC: 400 V / 19 A / 0.2 - 4 mm ² UL: 300 V / 15 A / AWG 30 - AWG 12	Box

**OMNIMATE Signal - series BL/SL 5.08
SLDF 5.08 L/F 6 SN OR BX**

Weidmüller Interface GmbH & Co. KG
Klingenbergstraße 16
D-32758 Detmold
Germany
Fon: +49 5231 14-0
Fax: +49 5231 14-292083
www.weidmueller.com

Mating connector (fully pluggable)
BLL 5.08/180

Female header for PCB mounting. The solder pin length is optimised for wave flow soldering.

- 400 V (IEC) / 300 V (UL)
- 23 A (IEC) / 15 A (UL)

General ordering data

Type	Order No.	Version	GTIN (EAN)	Qty.	Product data	Packaging
BLL 5.08/06/180 3.2 SN OR BX	1630750000	PCB plug-in connector, female header, closed side, Solder connection, 5.08 mm, No. of poles: 6, 180°, Solder pin length (l): 3.2 mm, tinned, Orange, Box	4008190204174	60 pc(s).	IEC: 400 V / 23 A UL: 300 V / 15 A	Box

BLF 5.08/90 SN

Just as reliable as the tried-and-tested original, with innovation in detail:

the BLF 5.08, PUSH-IN version of the BLZ 5.08 female header, features a new connection system and a more compact design. Weidmüller innovative PUSH-IN spring connection features a trend-setting, tool-free wire connection system that is simple to operate.

In terms of versatility, the BLF 5.08 offers just as much as the older versions:

- The choice of three wire outlet directions offers you proven design flexibility for your applications.
- Four flange variations, including the patented release latch, so you can design the interlock based on the requirements of the user.
- Use the BLF 5.08 and SL 5.08HC plug combination in order to reach the max. rated specifications.

General ordering data

Type	Order No.	Version	GTIN (EAN)	Qty.	Product data	Packaging
BLF 5.08HC/06/90 SN OR BX	1001570000	PCB plug-in connector, female plug, 5.08 mm, No. of poles: 6, 90°, PUSH IN spring connection, Clamping range, rated connection, max.: 3.31 mm ² , Box	4032248693375	60 pc(s).	IEC: 400 V / 24 A / 0.2 - 2.5 mm ² UL: 300 V / 18.5 A / AWG 26 - AWG 12	Box
BLF 5.08HC/06/90 SN BK BX	1000070001	PCB plug-in connector, female plug, 5.08 mm, No. of poles: 6, 90°, PUSH IN spring connection, Clamping range, rated	4032248690008	60 pc(s).	IEC: 400 V / 24 A / 0.2 - 2.5 mm ² UL: 300 V / 18.5 A / AWG 26 - AWG 12	Box

**OMNIMATE Signal - series BL/SL 5.08
SLDF 5.08 L/F 6 SN OR BX**

Weidmüller Interface GmbH & Co. KG
Klingenbergstraße 16
D-32758 Detmold
Germany
Fon: +49 5231 14-0
Fax: +49 5231 14-292083
www.weidmueller.com

Mating connector (fully pluggable)

connection, max.: 3.31
mm², Box

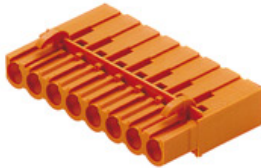
BLC 5.08R

Female plugs with crimp wire connection system. The female plugs provide space for labelling and can be coded.

- 0.25 - 2.5 mm² (IEC) / 26 - 14 AWG (UL)
- 400 V (IEC) / 300 V (UL)
- 21 A (IEC) / 10 A (UL)

General ordering data

Type	Order No.	Version	GTIN (EAN)	Qty.	Product data	Packaging
BLC 5.08/06/180R BK BX	1712000000	PCB plug-in connector, female plug, 5.08 mm, No. of poles: 6, 180°, Crimp connection, Clamping range, rated connection, max.: 2.5 mm ² , Box	4008190935016	50 pc(s).	IEC: 400 V / 21 A UL: 300 V / 10 A / AWG 26 - AWG 14	Box
BLC 5.08/06/180R OR BX	1610530000	PCB plug-in connector, female plug, 5.08 mm, No. of poles: 6, 180°, Crimp connection, Clamping range, rated connection, max.: 2.5 mm ² , Box	4008190123819	50 pc(s).	IEC: 400 V / 21 A UL: 300 V / 10 A / AWG 26 - AWG 14	Box

