

OMNIMATE Signal - series BL/SL 5.08
SLDF 5.08 L/F 8 SN OR BX

Weidmüller Interface GmbH & Co. KG
 Klingenbergstraße 16
 D-32758 Detmold
 Germany
 Fon: +49 5231 14-0
 Fax: +49 5231 14-292083
 www.weidmueller.com



Male connector for through-panel mounting with optional locking function. Internal connection as flat-blade or solder connection. These male connectors provide space for labelling and can be coded.

- 400 V (IEC) / 300 V (UL)
- 15 A (IEC) / 10 A (UL)

General ordering data

Type	SLDF 5.08 L/F 8 SN OR BX
Order No.	1599190000
Version	PCB plug-in connector, male header, 5.08 mm, No. of poles: 8, 180°, Flat-blade connection, Solder connection, Box
GTIN (EAN)	4008190126544
Qty.	50 pc(s).
Product data	IEC: 400 V / 15 A UL: 300 V / 10 A
Packaging	Box

OMNIMATE Signal - series BL/SL 5.08
SLDF 5.08 L/F 8 SN OR BX

Weidmüller Interface GmbH & Co. KG
 Klingenbergstraße 16
 D-32758 Detmold
 Germany
 Fon: +49 5231 14-0
 Fax: +49 5231 14-292083
 www.weidmueller.com

Technical data**Dimensions and weights**

Net weight	8.56 g
------------	--------

System parameters

Product family	OMNIMATE Signal - series BL/SL 5.08	Wire connection method	Flat-blade connection, Solder connection
Conductor outlet direction	180°	Pitch in mm (P)	5.08 mm
Pitch in inches (P)	0.2 inch	No. of poles	8
L1 in mm	35.56 mm	L1 in inches	1.4 inch

Material data

Insulating material	PBT	Colour	Orange
Colour chart (similar)	RAL 2000	UL 94 flammability rating	V-0
CTI	≥ 200	Contact material	CuSn
Contact surface	tinned	Operating temperature, min.	-50 °C
Operating temperature, max.	100 °C	Temperature range, installation, min.	-25 °C
Temperature range, installation, max.	100 °C		

Rating data acc. to IEC 60664-1 / IEC 61984

Rated current, min. no. of poles (Tu=20°C)	15 A	Rated current, number of poles (Tu=40°C), min	13 A
Rated voltage for surge voltage class / pollution degree II/2	400 V	Rated voltage for surge voltage class / pollution degree III/2	320 V
Rated voltage for surge voltage class / pollution degree III/3	250 V	Rated impulse voltage for surge voltage class/ pollution degree II/2	4 kV
Rated impulse voltage for surge voltage class/ pollution degree III/2	4 kV	Rated impulse voltage for surge voltage class/ contamination degree III/3	4 kV

CSA rating data

Institute (CSA)		Certificate No. (CSA)	200039-1121690
Rated voltage (Use group B)	300 V	Rated current (use group B)	10 A
Rated voltage (use group D)	300 V	Rated current (use group D)	10 A

UL 1059 rating data

Institute (UR)		Certificate No. (UR)	E60693
Rated voltage (use group B)	300 V	Rated current (use group B)	10 A
Rated voltage (use group D)	300 V	Rated current (use group D)	10 A

Classifications

ETIM 3.0	EC001284	UNSPSC	30-21-18-10
eClass 5.1	27-26-07-04	eClass 6.2	27-26-07-04
eClass 7.1	27-44-04-02		

Data sheet**OMNIMATE Signal - series BL/SL 5.08
SLDF 5.08 L/F 8 SN OR BX**

Weidmüller Interface GmbH & Co. KG
Klingenbergstraße 16
D-32758 Detmold
Germany
Fon: +49 5231 14-0
Fax: +49 5231 14-292083
www.weidmueller.com

Technical data**Notes**

Notes

- Additional colours on request
- Rated current related to rated cross-section & min. No. of poles.
- Connectable cables with solder connection solid and flexible up to 2.5 mm² with insulating/shrink-wrap sleeve or from 2.8 mm flat blade receptacles with insulated sleeves acc. to DIN IEC 760
- P on drawing = pitch
- Rated data refer only to the component itself. Clearance and creepage distances to other components are to be designed in accordance with the relevant application standards.

Approvals

Approvals



ROHS

Conform

Data sheet

**OMNIMATE Signal - series BL/SL 5.08
SLDF 5.08 L/F 8 SN OR BX**

Weidmüller Interface GmbH & Co. KG
 Klingenbergstraße 16
 D-32758 Detmold
 Germany
 Fon: +49 5231 14-0
 Fax: +49 5231 14-292083
 www.weidmueller.com

Drawings

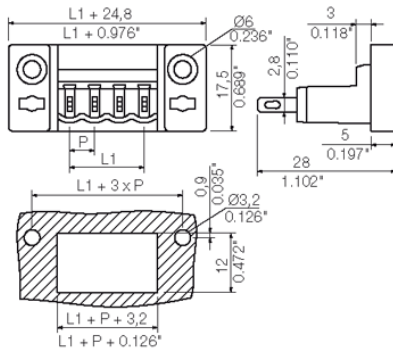

**OMNIMATE Signal - series BL/SL 5.08
SLDF 5.08 L/F 8 SN OR BX**

Weidmüller Interface GmbH & Co. KG
Klingenbergstraße 16
D-32758 Detmold
Germany
Fon: +49 5231 14-0
Fax: +49 5231 14-292083
www.weidmueller.com

Mating connector (conditionally pluggable)
BLZP 5.08/225B SN

Clamping-yoke wire connection with right-angled (90° or 270°) or angled (225°) outlet direction. The female plugs provide space for labelling and can be coded. Can be fastened with flange or release latch. They also feature the integrated plus/minus screw, protection from under insertion of wire, and are delivered with open clamping yoke.

- 0.2 – 2.5 mm² (IEC) / 26-12 AWG (UL)
- 400 V (IEC) / 300 V (UL)
- 17.5 A (IEC) / 10 A (UL)

General ordering data

Type	Order No.	Version	GTIN (EAN)	Qty.	Product data	Packaging
BLZP 5.08HC/08/225B SN OR BX	1945810000	PCB plug-in connector, female plug, 5.08 mm, No. of poles: 8, 225°, Clamping yoke connection, Clamping range, rated connection, max.: 4 mm ² , Box	4032248621286	42 pc(s).	IEC: 400 V / 17.5 A / 0.2 - 4 mm ² UL: 300 V / 15 A / AWG 30 - AWG 12	Box
BLZP 5.08HC/08/225B SN BK BX	1946040000	PCB plug-in connector, female plug, 5.08 mm, No. of poles: 8, 225°, Clamping yoke connection, Clamping range, rated connection, max.: 4 mm ² , Box	4032248621576	42 pc(s).	IEC: 400 V / 17.5 A / 0.2 - 4 mm ² UL: 300 V / 15 A / AWG 30 - AWG 12	Box

BLZF 5.08/180B

Female plugs with tension-clamp wire connection system, straight 180° outlet direction. The female plugs provide space for labelling and can be coded.

- 0.2 - 2.5 mm² (IEC) / 26 - 12 AWG (UL)
- 400 V (IEC) / 300 V (UL)
- 17 A (IEC) / 15 A (UL)

General ordering data

Delivery status	Available until	Type	Order No.	Version	GTIN (EAN)	Qty.
This article will no longer be available in the future.	2015-12-31T00:00:00+01:00	BLZF 5.08/08/180B SN OR BX	1708360000	PCB plug-in connector, female plug, 5.08 mm, No. of poles: 8, 180°, Tension clamp connection, Clamping range, rated connection, max.: 3.31 mm ² , Box	4008190317829	42 pc(s).

**OMNIMATE Signal - series BL/SL 5.08
SLDF 5.08 L/F 8 SN OR BX**

Weidmüller Interface GmbH & Co. KG
Klingenbergstraße 16
D-32758 Detmold
Germany
Fon: +49 5231 14-0
Fax: +49 5231 14-292083
www.weidmueller.com

Mating connector (conditionally pluggable)

BLZF 5.08/90B



Female plugs with tension-clamp wire connection system. The female plugs provide space for labelling and can be coded.

- 0.2 - 2.5 mm² (IEC) / 26 - 12 AWG (UL)
- 400 V (IEC) / 300 V (UL)
- 16.5 A (IEC) / 10 A (UL)

General ordering data

Delivery status	Available until	Type	Order No.	Version	GTIN (EAN)	Qty.
This article will no longer be available in the future.	2015-12-31T00:00:00+01:00	BLZF 5.08/08/90B SN OR BX	1671310000	PCB plug-in connector, female plug, 5.08 mm, No. of poles: 8, 90°, Tension clamp connection, Clamping range, rated connection, max.: 3.31 mm ² , Box	4008190433017	42 pc(s).
	2011-09-30T00:00:00+01:00	BLZF 5.08/08/90B SN BK BX	1671540000	PCB plug-in connector, female plug, 5.08 mm, No. of poles: 8, 90°, Tension clamp connection, Clamping range, rated connection, max.: 3.31 mm ² , Box	400819043324642	42 pc(s).
						IEC: 400 V / 16.5 A / 0.2 - 2.5 mm ² UL: 300 V / 10 A / 26 AWG -

OMNIMATE Signal - series BL/SL 5.08 SLDF 5.08 L/F 8 SN OR BX

Weidmüller Interface GmbH & Co. KG
 Klingenbergstraße 16
 D-32758 Detmold
 Germany
 Fon: +49 5231 14-0
 Fax: +49 5231 14-292083
 www.weidmueller.com

Mating connector (conditionally pluggable)

ZZ_Varianten



Female plugs with clamping-yoke screw for wire connection with straight (180°) outlet direction. The female plugs provide space for labelling and can be coded.

- 0.2 - 2.5 mm² (IEC) / 26 - 12 AWG (UL)
- 400 V (IEC) / 300 V (UL)
- 19 A (IEC) / 15 A (UL)

General ordering data

Type	Order No.	Version	GTIN (EAN)	Qty.	Product data	Packaging
BLZ 5.08/08/180B SN DKGX BX	1529350000	PCB plug-in connector, female plug, 5.08 mm, No. of poles: 8, 180°, Clamping yoke connection, Clamping range, rated connection, max.: 3.31 mm ² , Box	4008190290245	50 pc(s).	IEC: 400 V / 19 A / 0.2 - 2.5 mm ² UL: 300 V / 15 A / AWG 26 - AWG 12	Box

BLZ 5.08/90B



Female plugs with clamping-yoke screw connection. The female plugs provide space for labelling and can be coded.

- 0.2 - 2.5 mm² (IEC) / 26 - 12 AWG (UL)
- 400 V (IEC) / 300 V (UL)
- 15 A (IEC) / 10 A (UL)

General ordering data

Delivery status	Available until	Type	Order No.	Version	GTIN (EAN)	Qty.
This article will no longer be available in the future.	2015-12-31T00:00:00+01:00	BLZ 5.08/08/90B SN OR BX	1555660000	PCB plug-in connector, female plug, 5.08 mm, No. of poles: 8, 90°, Clamping yoke connection, Clamping range, rated connection, max.: 3.31 mm ² , Box	4008190136413	42 pc(s).

OMNIMATE Signal - series BL/SL 5.08 SLDF 5.08 L/F 8 SN OR BX

Weidmüller Interface GmbH & Co. KG
 Klingenbergstraße 16
 D-32758 Detmold
 Germany
 Fon: +49 5231 14-0
 Fax: +49 5231 14-292083
 www.weidmueller.com

Mating connector (conditionally pluggable)

BLDT 5.08B



Female plugs with two clamping-yoke screw connections per pole for wire connections with 90° and 270° outlet directions. The female plugs provide space for labelling and can be coded.

- 0.2 - 2.5 mm² (IEC) / 26 - 12 AWG (UL)
- 400 V (IEC) / 300 V (UL)
- 14 A (IEC) / 10 A (UL)

General ordering data

Available until	Type	Order No.	Version	GTIN (EAN)	Qty.	Product data
2014-05-20	BLDT 5.08/08-B SN BK BX	1673840000	PCB plug-in connector, female plug, 5.08 mm, No. of poles: 8, 180°, TOP connection, Clamping range, rated connection, max.: 3.31 mm ² , Box	4008190435578	50 pc(s).	IEC: 400 V / 14 A / 0.2 - 2.5 mm ² UL: 300 V / 10 A / AWG 26 - AWG 12
BLDT 5.08/08-B SN OR BX	1651800000	PCB plug-in connector, female plug, 5.08 mm, No. of poles: 8, 180°, TOP connection, Clamping range, rated connection, max.: 3.31 mm ² , Box	4008190400484	35 pc(s).	IEC: 400 V / 14 A / 0.2 - 2.5 mm ² UL: 300 V / 10 A / AWG 26 - AWG 12	Box

**OMNIMATE Signal - series BL/SL 5.08
SLDF 5.08 L/F 8 SN OR BX**

Weidmüller Interface GmbH & Co. KG
Klingenbergstraße 16
D-32758 Detmold
Germany
Fon: +49 5231 14-0
Fax: +49 5231 14-292083
www.weidmuller.com

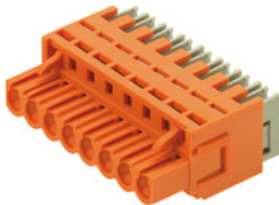
Mating connector (conditionally pluggable)
BLIDC 5.08B

Female plugs with IDC wire connection system. The female plugs provide space for labelling and can be coded.

- 0.35 - 0.75 mm² (IEC) / 22 - 20 AWG (UL)
- 400 V (IEC) / 300 V (UL)
- 11 A (IEC) / 5 A (UL)

General ordering data

Available until	Type	Order No.	Version	GTIN (EAN)	Qty.	Product data
2009-12-31	BLIDC 5.08/180B SN BK BX	1759670000	PCB plug-in connector, female plug, 5.08 mm, No. of poles: 8, 180°, IDC terminal, Clamping range, rated connection, max.: 0.75 mm ² , Box	4032248069903	50 pc(s).	IEC: 400 V / 11 A / 0.5 - 0.75 mm ² UL: 300 V / 5 A / 22 AWG - 20 AWG

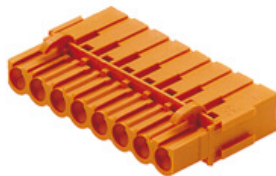
BLC 5.08BR

Female plugs with crimp wire connection system. The female plugs provide space for labelling and can be coded.

- 0.25 - 2.5 mm² (IEC) / 26 - 14 AWG (UL)
- 400 V (IEC) / 300 V (UL)
- 21 A (IEC) / 10 A (UL)

General ordering data

Type	Order No.	Version	GTIN (EAN)	Qty.	Product data	Packaging
BLC 5.08/08/180BR BK BX	1712170000	PCB plug-in connector, female plug, 5.08 mm, No. of poles: 8, 180°, Crimp connection, Clamping	4008190935184	50 pc(s).	IEC: 400 V / 21 A UL: 300 V / 10 A / AWG 26 - AWG 14	Box

**OMNIMATE Signal - series BL/SL 5.08
SLDF 5.08 L/F 8 SN OR BX**

Weidmüller Interface GmbH & Co. KG
Klingenbergstraße 16
D-32758 Detmold
Germany
Fon: +49 5231 14-0
Fax: +49 5231 14-292083
www.weidmueller.com

Mating connector (conditionally pluggable)

		range, rated connection, max.: 2.5 mm ² , Box			
BLC	1649430000	PCB plug-in connector, female plug, 5.08 mm, No. of poles: 8, 180°, Crimp connection, Clamping range, rated connection, max.: 2.5 mm ² , Box	4008190294540 50 pc(s).	IEC: 400 V / 21 A UL: 300 V / 10 A / AWG 26 - AWG 14	Box
5.08/08/180BR					
OR BX					

BLL 5.08/180B

Female header for PCB mounting. The solder pin length is optimised for wave flow soldering.

- 400 V (IEC) / 300 V (UL)
- 23 A (IEC) / 15 A (UL)

General ordering data

Type	Order No.	Version	GTIN (EAN)	Qty.	Product data	Packaging
BLL	1682790000	PCB plug-in connector, female header, Dovetails for fixing blocks, Solder connection, 5.08 mm, No. of poles: 8, 180°, Solder pin length (l): 3.2 mm, tinned, Orange, Box	4008190474553 42 pc(s).		IEC: 400 V / 23 A UL: 300 V / 15 A	Box
5.08/08/180B						
3.2SN OR BX						

BLZ 5.08/270B

Female plugs with clamping-yoke screw connection. The female plugs provide space for labelling and can be coded.

- 0.2 - 2.5 mm² (IEC) / 26 - 12 AWG (UL)
- 400 V (IEC) / 300 V (UL)
- 15 A (IEC) / 10 A (UL)

General ordering data

Available until	Type	Order No.	Version	GTIN (EAN)	Qty.	Product data
2008-06-30	BLZ 5.08/270B SN BK BX	1560210000	PCB plug-in connector, female plug, 5.08 mm, No. of poles: 8, 270°, Clamping yoke connection, Clamping range,	4008190269715 42 pc(s).		IEC: 400 V / 15 A / 0.2 -

Data sheet

**OMNIMATE Signal - series BL/SL 5.08
SLDF 5.08 L/F 8 SN OR BX**

Weidmüller Interface GmbH & Co. KG
Klingenbergstraße 16
D-32758 Detmold
Germany
Fon: +49 5231 14-0
Fax: +49 5231 14-292083
www.weidmueller.com

Mating connector (conditionally pluggable)

rated connection,	2.5
max.: 3.31 mm ² ,	mm ²
Box	UL:
	300
	V /
	10
	A /
	AWG
	26
	-
	AWG
	12

This article will no longer be available in the future.	2015-12-31T00:00:00+01:00	BLZ 5.08/08/270B SN OR 1560260000	PCB plug-in	4008190163396	42
		BX	connector, female plug, 5.08 mm, No. of poles: 8, 270°, Clamping yoke connection, Clamping range, rated connection, max.: 3.31 mm ² , Box		pc(s).

BLZF 5.08/270B



Female plugs with tension-clamp wire connection system. The female plugs provide space for labelling and can be coded.

- 0.2 - 2.5 mm² (IEC) / 26 - 12 AWG (UL)
- 400 V (IEC) / 300 V (UL)
- 16.5 A (IEC) / 10 A (UL)

General ordering data

Available until	Type	Order No.	Version	GTIN (EAN)	Qty.	Product data
2011-09-30T00:00:00	BLZF 5.08/270B SN BK BX	1672690000	PCB plug-in connector, female plug, 5.08 mm, No. of poles: 8, 270°, Tension clamp connection, Clamping range, rated connection, max.: 3.31 mm ² , Box	400819043440342	42 pc(s).	IEC: 400 V / 16.5 A / 0.2 - 2.5 mm ² UL: 300 V / 10 A / AWG 26

**OMNIMATE Signal - series BL/SL 5.08
SLDF 5.08 L/F 8 SN OR BX**

Weidmüller Interface GmbH & Co. KG
Klingenbergstraße 16
D-32758 Detmold
Germany
Fon: +49 5231 14-0
Fax: +49 5231 14-292083
www.weidmueller.com

Mating connector (conditionally pluggable)

This article will no longer be available in the future.	2015-12-31T00:00:00+01:00	BLZF 5.08/08/270B SN OR BX	1672460000	PCB plug-in connector, female plug, 5.08 mm, No. of poles: 8, 270°, Tension clamp connection, Clamping range, rated connection, max.: 3.31 mm², Box	4008190434175	- AWG 12 42 pc(s).
---	---------------------------	----------------------------	----------------------------	---	---------------	--------------------------------

BLZ 5.08/180B



Female plugs with clamping-yoke screw for wire connection with straight (180°) outlet direction. The female plugs provide space for labelling and can be coded.

- 0.2 - 2.5 mm² (IEC) / 26 - 12 AWG (UL)
- 400 V (IEC) / 300 V (UL)
- 19 A (IEC) / 15 A (UL)

General ordering data

Delivery status	Available until	Type	Order No.	Version	GTIN (EAN)	Qty.
This article will no longer be available in the future.	2015-12-31T00:00:00+01:00	BLZ 5.08/08/180B SN OR BX	1529360000	PCB plug-in connector, female plug, 5.08 mm, No. of poles: 8, 180°, Clamping yoke connection, Clamping range, rated connection, max.: 3.31 mm², Box	4008190115999	50 pc(s).
This article will no longer be available in the future.	2015-12-31T00:00:00+01:00	BLZ 5.08/08/180B SN BK BX	1529310000	PCB plug-in connector, female plug, 5.08 mm, No. of poles: 8, 180°, Clamping yoke connection, Clamping range, rated connection, max.: 3.31 mm², Box	4008190038601	50 pc(s).

**OMNIMATE Signal - series BL/SL 5.08
SLDF 5.08 L/F 8 SN OR BX**

Weidmüller Interface GmbH & Co. KG
Klingenbergstraße 16
D-32758 Detmold
Germany
Fon: +49 5231 14-0
Fax: +49 5231 14-292083
www.weidmueller.com

Mating connector (conditionally pluggable)

BLZ 5.08/225B



Female plugs with clamping-yoke screw for wire connection with 225° outlet direction. The female plugs provide space for labelling and can be coded.

- 0.2 - 2.5 mm² (IEC) / 26 - 12 AWG (UL)
- 400 V (IEC) / 300 V (UL)
- 16.5 A (IEC) / 10 A (UL)

General ordering data

Delivery status	Available until	Type	Order No.	Version	GTIN (EAN)	Qty.
This article will no longer be available in the future.	2015-12-31T00:00:00+01:00	BLZ 5.08/08/225B SN OR BX	1742160000	PCB plug-in connector, female plug, 5.08 mm, No. of poles: 8, 225°, Clamping yoke connection, Clamping range, rated connection, max.: 3.31 mm ² , Box	4008190247485	42 pc(s).
This article will no longer be available in the future.	2015-12-31T00:00:00+01:00	BLZ 5.08/08/225B SN BK BX	1742390000	PCB plug-in connector, female plug, 5.08 mm, No. of poles: 8, 225°, Clamping yoke connection, Clamping range, rated connection, max.: 3.31 mm ² , Box	4032248049813	42 pc(s).

**OMNIMATE Signal - series BL/SL 5.08
SLDF 5.08 L/F 8 SN OR BX**

Weidmüller Interface GmbH & Co. KG
Klingenbergstraße 16
D-32758 Detmold
Germany
Fon: +49 5231 14-0
Fax: +49 5231 14-292083
www.weidmueller.com

Mating connector (fully pluggable)
BLZ 5.08/225

Female plugs with clamping-yoke screw for wire connection with 225° outlet direction. The female plugs provide space for labelling and can be coded.

- 0.2 - 2.5 mm² (IEC) / 26 - 12 AWG (UL)
- 400 V (IEC) / 300 V (UL)
- 16.5 A (IEC) / 10 A (UL)

General ordering data

Delivery status	Available until	Type	Order No.	Version	GTIN (EAN)	Qty.
This article will no longer be available in the future.	2015-12-31T00:00:00+01:00	BLZ 5.08/08/225 SN BK BX	1741930000	PCB plug-in connector, female plug, 5.08 mm, No. of poles: 8, 225°, Clamping yoke connection, Clamping range, rated connection, max.: 3.31 mm ² , Box	4008190272876	42 pc(s).
This article will no longer be available in the future.	2015-12-31T00:00:00+01:00	BLZ 5.08/08/225 SN OR BX	1741700000	PCB plug-in connector, female plug, 5.08 mm, No. of poles: 8, 225°, Clamping yoke connection, Clamping range, rated connection, max.: 3.31 mm ² , Box	4008190219093	42 pc(s).

BLL 5.08/90

Female header for PCB mounting. The solder pin length is optimised for wave flow soldering.

- 400 V (IEC) / 300 V (UL)
- 23 A (IEC) / 15 A (UL)

General ordering data

Type	Order No.	Version	GTIN (EAN)	Qty.	Product data	Packaging
BLL 5.08/08/90 3.2 SN OR BX	1623000000	PCB plug-in connector, female header, closed side, Solder connection, 5.08 mm, No. of poles: 8, 90°	4008190194055	42 pc(s).	IEC: 400 V / 23 A UL: 300 V / 15 A	Box

Data sheet

**OMNIMATE Signal - series BL/SL 5.08
SLDF 5.08 L/F 8 SN OR BX**

Weidmüller Interface GmbH & Co. KG
Klingenbergstraße 16
D-32758 Detmold
Germany
Fon: +49 5231 14-0
Fax: +49 5231 14-292083
www.weidmueller.com

Mating connector (fully pluggable)

		Solder pin length (l): 3.2 mm, tinned, Orange, Box		
BLL	1730190000	PCB plug-in connector, female header, closed side, Solder connection, 5.08 mm, No. of poles: 8, 90°, Solder pin length (l): 3.2 mm, tinned, Black, Box	4050118007008 42 pc(s).	IEC: 400 V / 23 A UL: 300 V / 15 A
5.08/08/90				Box
3.2 SN BK BX				

BLZ 5.08/270



Female plugs with clamping-yoke screw connection. The female plugs provide space for labelling and can be coded.

- 0.2 - 2.5 mm² (IEC) / 26 - 12 AWG (UL)
- 400 V (IEC) / 300 V (UL)
- 15 A (IEC) / 10 A (UL)

General ordering data

Delivery status	Available until	Type	Order No.	Version	GTIN (EAN)	Qty.
This article will no longer be available in the future.	2015-12-31T00:00:00+01:00	BLZ 5.08/08/270 SN BK BX	1557910000	PCB plug-in connector, female plug, 5.08 mm, No. of poles: 8, 270°, Clamping yoke connection, Clamping range, rated connection, max.: 3.31 mm ² , Box	4008190269487	42 pc(s).
This article will no longer be available in the future.	2015-12-31T00:00:00+01:00	BLZ 5.08/08/270 SN OR BX	1557960000	PCB plug-in connector, female plug, 5.08 mm, No. of poles: 8, 270°, Clamping yoke connection, Clamping range, rated connection, max.: 3.31 mm ² , Box	4008190085902	42 pc(s).

**OMNIMATE Signal - series BL/SL 5.08
SLDF 5.08 L/F 8 SN OR BX**

Weidmüller Interface GmbH & Co. KG
Klingenbergstraße 16
D-32758 Detmold
Germany
Fon: +49 5231 14-0
Fax: +49 5231 14-292083
www.weidmueller.com

Mating connector (fully pluggable)
BLL 5.08/180

Female header for PCB mounting. The solder pin length is optimised for wave flow soldering.

- 400 V (IEC) / 300 V (UL)
- 23 A (IEC) / 15 A (UL)

General ordering data

Type	Order No.	Version	GTIN (EAN)	Qty.	Product data	Packaging
BLL 5.08/08/180 3.2 SN OR BX	1630770000	PCB plug-in connector, female header, closed side, Solder connection, 5.08 mm, No. of poles: 8, 180°, Solder pin length (l): 3.2 mm, tinned, Orange, Box	4008190204198 42 pc(s).		IEC: 400 V / 23 A UL: 300 V / 15 A	Box

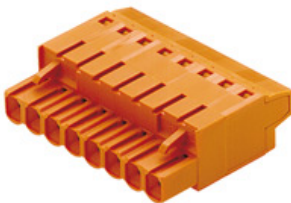
BLT 5.08

Female plugs with TOP screw system for connecting wires with straight 180° outlet direction. The female plugs provide space for labelling and can be coded.

- 0.2 - 2.5 mm² (IEC) / 26 - 14 AWG (UL)
- 400 V (IEC) / 300 V (UL)
- 17 A (IEC) / 10 A (UL)

General ordering data

Type	Order No.	Version	GTIN (EAN)	Qty.	Product data	Packaging
BLT 5.08HC/08/180 SN OR BX	1500160000	PCB plug-in connector, female plug, 5.08 mm, No. of poles: 8, 180°, TOP connection, Clamping range, rated connection, max.: 2.5 mm ² , Box	4008190099152 42 pc(s).		IEC: 400 V / 17 A / 0.2 - 2.5 mm ² UL: 300 V / 13 A / AWG 26 - AWG 14	Box
BLT 5.08HC/08/180 SN BK BX	1500110000	PCB plug-in connector, female plug, 5.08 mm, No. of poles: 8, 180°, TOP connection, Clamping range, rated connection, max.: 2.5 mm ² , Box	4008190861742 42 pc(s).		IEC: 400 V / 17 A / 0.2 - 2.5 mm ² UL: 300 V / 13 A / AWG 26 - AWG 14	Box

**OMNIMATE Signal - series BL/SL 5.08
SLDF 5.08 L/F 8 SN OR BX**

Weidmüller Interface GmbH & Co. KG
Klingenbergstraße 16
D-32758 Detmold
Germany
Fon: +49 5231 14-0
Fax: +49 5231 14-292083
www.weidmueller.com

Mating connector (fully pluggable)
BLZF 5.08/90

Female plugs with tension-clamp wire connection system. The female plugs provide space for labelling and can be coded.

- 0.2 - 2.5 mm² (IEC) / 26 - 12 AWG (UL)
- 400 V (IEC) / 300 V (UL)
- 16.5 A (IEC) / 10 A (UL)

General ordering data

Delivery status	Available until	Type	Order No.	Version	GTIN (EAN)	Qty.
This article will no longer be available in the future.	2015-12-31T00:00:00+01:00	BLZF 5.08/08/90 SN BK BX	1671080000	PCB plug-in connector, female plug, 5.08 mm, No. of poles: 8, 90°, Tension clamp connection, Clamping range, rated connection, max.: 3.31 mm ² , Box	4008190432751	42 pc(s).
This article will no longer be available in the future.	2015-12-31T00:00:00+01:00	BLZF 5.08/08/90 SN OR BX	1670850000	PCB plug-in connector, female plug, 5.08 mm, No. of poles: 8, 90°, Tension clamp connection, Clamping range, rated connection, max.: 3.31 mm ² , Box	4008190432454	42 pc(s).

BLZP 5.08/225 SN

Clamping-yoke wire connection with right-angled (90° or 270°) or angled (225°) outlet direction. The female plugs provide space for labelling and can be coded. Can be fastened with flange or release latch. They also feature the integrated plus/minus screw, protection from under insertion of wire, and are delivered with open clamping yoke.

- 0.2 - 2.5 mm² (IEC) / 26-12 AWG (UL)
- 400 V (IEC) / 300 V (UL)
- 17.5 A (IEC) / 10 A (UL)

General ordering data

Type	Order No.	Version	GTIN (EAN)	Qty.	Product data	Packaging
BLZP 5.08HC/08/225 SN BK BX	1946620000	PCB plug-in connector, female plug, 5.08 mm, No. of poles: 8, 225°, Clamping yoke connection, Clamping	4032248622399	42 pc(s).	IEC: 400 V / 17.5 A / 0.2 - 4 mm ² UL: 300 V / 15 A / AWG 30 - AWG 12	Box

**OMNIMATE Signal - series BL/SL 5.08
SLDF 5.08 L/F 8 SN OR BX**

Weidmüller Interface GmbH & Co. KG
Klingenbergstraße 16
D-32758 Detmold
Germany
Fon: +49 5231 14-0
Fax: +49 5231 14-292083
www.weidmuller.com

Mating connector (fully pluggable)

		range, rated connection, max.: 4 mm ² , Box		
BLZP 5.08HC/08/225 SN OR BX	1946310000	PCB plug-in connector, female plug, 5.08 mm, No. of poles: 8, 225°, Clamping yoke connection, Clamping range, rated connection, max.: 4 mm ² , Box	4032248621880 42 pc(s).	IEC: 400 V / 17.5 A / 0.2 - 4 mm ² Box UL: 300 V / 15 A / AWG 30 - AWG 12

BLDT 5.08

Female plugs with two clamping-yoke screw connections per pole for wire connections with 90° and 270° outlet directions. The female plugs provide space for labelling and can be coded.

- 0.2 - 2.5 mm² (IEC) / 26 - 12 AWG (UL)
- 400 V (IEC) / 300 V (UL)
- 14 A (IEC) / 10 A (UL)

General ordering data

Type	Order No.	Version	GTIN (EAN)	Qty.	Product data	Packaging
BLDT 5.08/08/- SN OR BX	1644790000	PCB plug-in connector, female plug, 5.08 mm, No. of poles: 8, 180°, TOP connection, Clamping range, rated connection, max.: 3.31 mm ² , Box	4008190284008 35 pc(s).		IEC: 400 V / 14 A / 0.2 - 2.5 mm ² UL: 300 V / 10 A / AWG 26 - AWG 12	Box
BLDT 5.08/08/- SN BK BX	1660770000	PCB plug-in connector, female plug, 5.08 mm, No. of poles: 8, 180°, TOP connection, Clamping range, rated connection, max.: 3.31 mm ² , Box	4008190417222 35 pc(s).		IEC: 400 V / 14 A / 0.2 - 2.5 mm ² UL: 300 V / 10 A / AWG 26 - AWG 12	Box

BLZF 5.08/180

Female plugs with tension-clamp wire connection system, straight 180° outlet direction. The female plugs provide space for labelling and can be coded.

- 0.2 - 2.5 mm² (IEC) / 26 - 12 AWG (UL)
- 400 V (IEC) / 300 V (UL)
- 17 A (IEC) / 15 A (UL)

General ordering data

Delivery status Available until	Type	Order No.	Version	GTIN (EAN)	Qty.
This article will 2015-12-31T00:00:00+01:00 no longer be	BLZF 5.08/08/180 SN OR BX	1707520000	PCB plug-in connector, female plug, 5.08 mm,	4008190395889	42 pc(s).

Creation date October 30, 2014 2:45:55 AM CET

Data sheet

**OMNIMATE Signal - series BL/SL 5.08
SLDF 5.08 L/F 8 SN OR BX**

Weidmüller Interface GmbH & Co. KG
Klingenbergstraße 16
D-32758 Detmold
Germany
Fon: +49 5231 14-0
Fax: +49 5231 14-292083
www.weidmueller.com

Mating connector (fully pluggable)

available in the future.

No. of poles: 8,
180°, Tension
clamp connection,
Clamping range,
rated connection,
max.: 3.31 mm²,
Box

This article will no longer be available in the future.	2015-12-31T00:00:00+01:00	BLZF 5.08/08/180 SN BK BX	1707750000	PCB plug-in connector, female plug, 5.08 mm, No. of poles: 8, 180°, Tension clamp connection, Clamping range, rated connection, max.: 3.31 mm ² , Box	4008190316754	42 pc(s).
---	---------------------------	---------------------------	----------------------------	--	---------------	-----------

BLC 5.08R



Female plugs with crimp wire connection system. The female plugs provide space for labelling and can be coded.

- 0.25 - 2.5 mm² (IEC) / 26 - 14 AWG (UL)
- 400 V (IEC) / 300 V (UL)
- 21 A (IEC) / 10 A (UL)

General ordering data

Type	Order No.	Version	GTIN (EAN)	Qty.	Product data	Packaging
BLC 5.08/08/180R OR BX	1610550000	PCB plug-in connector, female plug, 5.08 mm, No. of poles: 8, 180°, Crimp connection, Clamping range, rated connection, max.: 2.5 mm ² , Box	4008190080563	50 pc(s).	IEC: 400 V / 21 A UL: 300 V / 10 A / AWG 26 - AWG 14	Box
BLC 5.08/08/180R BK BX	1712020000	PCB plug-in connector, female plug, 5.08 mm, No. of poles: 8, 180°, Crimp connection, Clamping range, rated connection, max.: 2.5 mm ² , Box	4008190935030	50 pc(s).	IEC: 400 V / 21 A UL: 300 V / 10 A / AWG 26 - AWG 14	Box

**OMNIMATE Signal - series BL/SL 5.08
SLDF 5.08 L/F 8 SN OR BX**

Weidmüller Interface GmbH & Co. KG
Klingenbergstraße 16
D-32758 Detmold
Germany
Fon: +49 5231 14-0
Fax: +49 5231 14-292083
www.weidmuller.com

Mating connector (fully pluggable)
BLZP 5.08/180 SN

Female plugs with clamping-yoke screw for wire connection with straight (180°) outlet direction. The female plugs provide space for labelling and can be coded. Can be fastened with flange or release latch. They also feature the integrated plus/minus screw, protection from under insertion of wire, and are delivered with open clamping yoke.

- 0.2 – 2.5 mm² (IEC) / 26-12 AWG (UL)
- 400 V (IEC) / 300 V (UL)
- 19 A (IEC) / 15 A (UL)

General ordering data

Type	Order No.	Version	GTIN (EAN)	Qty.	Product data	Packaging
BLZP 5.08HC/08/180 SN OR BX	1943640000	PCB plug-in connector, female plug, 5.08 mm, No. of poles: 8, 180°, Clamping yoke connection, Clamping range, rated connection, max.: 4 mm ² , Box	4032248617647	45 pc(s).	IEC: 400 V / 19 A / 0.2 - 4 mm ² UL: 300 V / 15 A / AWG 30 - AWG 12	Box
BLZP 5.08HC/08/180 SN BK BX	1943870000	PCB plug-in connector, female plug, 5.08 mm, No. of poles: 8, 180°, Clamping yoke connection, Clamping range, rated connection, max.: 4 mm ² , Box	4032248617913	45 pc(s).	IEC: 400 V / 19 A / 0.2 - 4 mm ² UL: 300 V / 15 A / AWG 30 - AWG 12	Box

BLZ 5.08/90

Female plugs with clamping-yoke screw connection. The female plugs provide space for labelling and can be coded.

- 0.2 - 2.5 mm² (IEC) / 26 - 12 AWG (UL)
- 400 V (IEC) / 300 V (UL)
- 15 A (IEC) / 10 A (UL)

General ordering data

Delivery status Available until	Type	Order No.	Version	GTIN (EAN)	Qty.
This article will no longer be available in the future.	BLZ 5.08/08/90 SN BK BX	1553310000	PCB plug-in connector, female plug, 5.08 mm, No. of poles: 8, 90°, Clamping yoke connection, Clamping range, rated connection, max.: 3.31 mm ² , Box	4008190267773	42 pc(s).
This article will no longer be available in the future.	BLZ 5.08/08/90 SN OR BX	1553360000	PCB plug-in connector, female	4008190001315	42 pc(s).

Data sheet

**OMNIMATE Signal - series BL/SL 5.08
SLDF 5.08 L/F 8 SN OR BX**

Weidmüller Interface GmbH & Co. KG
Klingenbergstraße 16
D-32758 Detmold
Germany
Fon: +49 5231 14-0
Fax: +49 5231 14-292083
www.weidmueller.com

Mating connector (fully pluggable)

available in the future.

plug, 5.08 mm,
No. of poles: 8,
90°, Clamping
yoke connection,
Clamping range,
rated connection,
max.: 3.31 mm²,
Box

BL 5.08



Female plugs with leaf-spring wire connection system. The female plugs provide space for labelling.

- 0.2 - 1.5 mm² (IEC) / 26 - 14 AWG (UL)
- 400 V (IEC) / 300 V (UL)
- 11 A (IEC) / 10 A (UL)

General ordering data

Delivery status	Available until	Type	Order No.	Version	GTIN (EAN)	Qty.
This article will no longer be available in the future.	2015-12-31T00:00:00+01:00	BL 5.08/08/180 SN OR BX	1716380000	PCB plug-in connector, female plug, 5.08 mm, No. of poles: 8, 180°, Pressure clamp connection, Clamping range, rated connection, max.: 2.08 mm ² , Box	4008190376420	50 pc(s)
This article will no longer be available in the future.	2015-12-31T00:00:00+01:00	BL 5.08/08/180 SN BK BX	1716530000	PCB plug-in connector, female plug, 5.08 mm, No. of poles: 8, 180°, Pressure clamp connection, Clamping range, rated connection, max.: 2.08 mm ² , Box	4008190376604	50 pc(s)
This article will no longer be available in the future.	2015-12-31T00:00:00+01:00	BL 5.08/08/180 SN DKGN BX	1723890000	PCB plug-in connector, female plug, 5.08 mm, No. of poles: 8, 180°, Pressure clamp connection, Clamping range, rated connection,	4008190376253	50 pc(s)

OMNIMATE Signal - series BL/SL 5.08 SLDF 5.08 L/F 8 SN OR BX

Weidmüller Interface GmbH & Co. KG
 Klingenbergstraße 16
 D-32758 Detmold
 Germany
 Fon: +49 5231 14-0
 Fax: +49 5231 14-292083
 www.weidmueller.com

Mating connector (fully pluggable)

max.: 2.08 mm²,
 Box

BLZP 5.08/270 SN



Female plugs with clamping-yoke screw connection for wire connection and a right-angle (90° or 270°) outlet direction. The female plugs provide space for labelling and can be coded. Can be fastened with flange or release latch. They feature an integrated plus/minus screw, protection against false insertion under clamping yoke. They are delivered with an opened clamping yoke.

- 0.2 – 2.5 mm² (IEC) / 26-12 AWG (UL)
- 400 V (IEC) / 300 V (UL)
- 15 A (IEC) / 10 A (UL)

General ordering data

Type	Order No.	Version	GTIN (EAN)	Qty.	Product data	Packaging
BLZP 5.08HC/08/270 SN OR BX	1948850000	PCB plug-in connector, female plug, 5.08 mm, No. of poles: 8, 270°, Clamping yoke connection, Clamping range, rated connection, max.: 4 mm ² , Box	4032248626304	42 pc(s).	IEC: 400 V / 15.5 A / 0.2 - 4 mm ² UL: 300 V / 15 A / AWG 30 - AWG 12	Box
BLZP 5.08HC/08/270 SN BK BX	1949080000	PCB plug-in connector, female plug, 5.08 mm, No. of poles: 8, 270°, Clamping yoke connection, Clamping range, rated connection, max.: 4 mm ² , Box	4032248626533	42 pc(s).	IEC: 400 V / 15.5 A / 0.2 - 4 mm ² UL: 300 V / 15 A / AWG 30 - AWG 12	Box

BLZ 5.08/180



Female plugs with clamping-yoke screw for wire connection with straight (180°) outlet direction. The female plugs provide space for labelling and can be coded.

- 0.2 - 2.5 mm² (IEC) / 26 - 12 AWG (UL)
- 400 V (IEC) / 300 V (UL)
- 19 A (IEC) / 15 A (UL)

General ordering data

Delivery status Available until	Type	Order No.	Version	GTIN (EAN)	Qty.
This article will no longer be available in the future.	BLZ 5.08/08/180 SN OR BX	1527060000	PCB plug-in connector, female plug, 5.08 mm, No. of poles: 8, 180°, Clamping yoke connection, Clamping range, rated connection,	4008190152314	50 pc(s).

**OMNIMATE Signal - series BL/SL 5.08
SLDF 5.08 L/F 8 SN OR BX**

Weidmüller Interface GmbH & Co. KG
Klingenbergstraße 16
D-32758 Detmold
Germany
Fon: +49 5231 14-0
Fax: +49 5231 14-292083
www.weidmueller.com

Mating connector (fully pluggable)

This article will no longer be available in the future.	2015-12-31T00:00:00+01:00	BLZ 5.08/08/180 SN BK BX	1527010000	max.: 3.31 mm ² , Box	4008190138967	50
				PCB plug-in connector, female plug, 5.08 mm, No. of poles: 8, 180°, Clamping yoke connection, Clamping range, rated connection, max.: 3.31 mm ² , Box		

BLZF 5.08/270



Female plugs with tension-clamp wire connection system. The female plugs provide space for labelling and can be coded.

- 0.2 - 2.5 mm² (IEC) / 26 - 12 AWG (UL)
- 400 V (IEC) / 300 V (UL)
- 16.5 A (IEC) / 10 A (UL)

General ordering data

Delivery status	Available until	Type	Order No.	Version	GTIN (EAN)	Qty.
This article will no longer be available in the future.	2015-12-31T00:00:00+01:00	BLZF 5.08/08/270 SN BK BX	1672230000	PCB plug-in connector, female plug, 5.08 mm, No. of poles: 8, 270°, Tension clamp connection, Clamping range, rated connection, max.: 3.31 mm ² , Box	4008190433949	42 pc(s).
2014-06-23T00:00:00+01:00	2015-06-23T00:00:00+01:00	BLZF 5.08/08/270 SN OR BX	1672000000	PCB plug-in connector, female plug, 5.08 mm, No. of poles: 8, 270°, Tension clamp connection, Clamping range, rated connection, max.: 3.31 mm ² , Box	400819043371042	42 pc(s).
						IEC: 400 V / 16.5 A / 0.2 - 2.5 mm ² UL: 300 V / 10 A / 26 AWG -

Data sheet

**OMNIMATE Signal - series BL/SL 5.08
SLDF 5.08 L/F 8 SN OR BX**

Weidmüller Interface GmbH & Co. KG
Klingenbergstraße 16
D-32758 Detmold
Germany
Fon: +49 5231 14-0
Fax: +49 5231 14-292083
www.weidmueller.com

Mating connector (fully pluggable)

AWG
12

BLIDC 5.08



Female plugs with IDC wire connection system. The female plugs provide space for labelling and can be coded.

- 0.35 - 0.75 mm² (IEC) / 22 - 20 AWG (UL)
- 400 V (IEC) / 300 V (UL)
- 11 A (IEC) / 5 A (UL)

General ordering data

Available until	Type	Order No.	Version	GTIN (EAN)	Qty.	Product data
2009-12-31	BLIDC 5.08 / 180 SN OR BX	1725000000	PCB plug-in connector, female plug, 5.08 mm, No. of poles: 8, 180°, IDC terminal, Clamping range, rated connection, max.: 0.75 mm ² , Box	400819037734250	pc(s).	IEC: 400 V / 11 A / 0.5 - 0.75 mm ² UL: 300 V / 5 A / 22 AWG 20

**OMNIMATE Signal - series BL/SL 5.08
SLDF 5.08 L/F 8 SN OR BX**

Weidmüller Interface GmbH & Co. KG
Klingenbergstraße 16
D-32758 Detmold
Germany
Fon: +49 5231 14-0
Fax: +49 5231 14-292083
www.weidmueller.com

Mating connector (fully pluggable)
BLF 5.08/90 SN

Just as reliable as the tried-and-tested original, with innovation in detail: the BLF 5.08, PUSH-IN version of the BLZ 5.08 female header, features a new connection system and a more compact design. Weidmüller innovative PUSH-IN spring connection features a trend-setting, tool-free wire connection system that is simple to operate. In terms of versatility, the BLF 5.08 offers just as much as the older versions:

- The choice of three wire outlet directions offers you proven design flexibility for your applications.
- Four flange variations, including the patented release latch, so you can design the interlock based on the requirements of the user.
- Use the BLF 5.08 and SL 5.08HC plug combination in order to reach the max. rated specifications.

General ordering data

Type	Order No.	Version	GTIN (EAN)	Qty.	Product data	Packaging
BLF 5.08HC/08/90 SN OR BX	1001590000	PCB plug-in connector, female plug, 5.08 mm, No. of poles: 8, 90°, PUSH IN spring connection, Clamping range, rated connection, max.: 3.31 mm ² , Box	4032248693399	42 pc(s).	IEC: 400 V / 24 A / 0.2 - 2.5 mm ² UL: 300 V / 18.5 A / AWG 26 - AWG 12	Box
BLF 5.08HC/08/90 SN BK BX	1000090001	PCB plug-in connector, female plug, 5.08 mm, No. of poles: 8, 90°, PUSH IN spring connection, Clamping range, rated connection, max.: 3.31 mm ² , Box	4032248690022	42 pc(s).	IEC: 400 V / 24 A / 0.2 - 2.5 mm ² UL: 300 V / 18.5 A / AWG 26 - AWG 12	Box

Addresses worldwide

Let's connect.

- AE United Arab Emirates**
Weidmüller Middle East FZE
Warehouse Q3-79
SAIF-Zone
P.O. BOX 8591
Sharjah
Tel. +971 65572723
Fax +971 65572724
wme.info@weidmueller.com
- AO Angola**
Please contact
Phambili Interface
South Africa
- AR Argentina**
CPI SA
Bauness 2660
C1431DOF Buenos Aires
Tel. +54 11 4523 8008
Fax +54 11 4522 0546
info@cpi.com.ar
www.cpi.com.ar
- AT Austria**
Weidmüller GmbH
IZ NOE Süd Straße 2b, Obj
M 59
2355 Wiener Neudorf
Tel. +43 2236 67080
Fax +43 2236 6708-899
office.at@weidmueller.com
www.weidmueller.com
- AU Australia**
Weidmüller Pty. Ltd.
PO BOX 6944
Huntingwood 2148
Huntingwood Drive 43
Huntingwood NSW 2148
Tel. +61 2 9671 9999
Fax +61 2 9671 9911
info@weidmuller.com.au
www.weidmuller.com.au
- AZ Azerbaijan**
Representative Office
Rashad Mahmudov
Demirchi Tower, 4th floor
37, Khojali ave.
AZ 1025 Baku
Tel. +994 12 488 80 36
Fax +994 12 488 80 37
rashad.mahmudov@weidmueller.com
- BA Bosnia and Herzegovina**
Please contact
our Representative Office
Weidmüller Interface GmbH
& Co. KG
Serbia

or
BIG electric d.o.o
Mladena Stojanovića 117A
78000 Banja Luka
Tel. +387 51926277
Fax +387 51926277
bigelectric@blic.net
www.bigelectric.ba
- BE Belgium**
Weidmüller Benelux B. V.
Mechelsesteenweg 519 bus
6 en 7
1930 Nossegem
Tel. +32 2 752 40 70
Fax +32 2 751 36 06
info@weidmueller.be
www.weidmueller.be
- BG Bulgaria**
Weid-Bul EOOD
Bul. „Kliment Ohridski“ 13
1756 Sofia
Tel. +359 2 963 2560
Fax +359 2 963 1098
sofia@weidbul.com
www.weidbul.com
- BH Bahrain**
Khayber Trading Company
P.O. Box 1976
Manama
Tel. +973 720747
Fax +973 720331
khayber@batelco.com.bh
- BR Brazil**
Weidmüller Conexel do Brasil
Conexes Elétricas Ltda.
Av. Presidente Juscelino, 642
- Piraporinha
Diadema, São Paulo
09950-370
Tel. +55 (11) 4366-9600
Fax +55 (11) 4362-1677
vendas@weidmueller.com.br
www.weidmueller.com.br
- BW Botswana**
Please contact
Phambili Interface
South Africa
- BY Belarus**
TECHNIKON Ltd.
Nezavisimosti pr. 177-9
220125 Minsk
Tel. +375 17 393-11-77
Fax +375 17 3930080
wm@technikon.by
- CA Canada**
W Interconnections Canada
Inc.
10 Spy Court
Markham Ontario L3R 5H6
Tel. +1 (905) 475-1507
Ext. 9836
Fax +1 (905) 475-2798
support@weidmuller.ca
www.weidmuller.ca
- CG Congo**
Please contact
Phambili Interface
South Africa
- CH Switzerland**
Weidmüller Schweiz AG
Rundbuckstraße 2
8212 Neuhausen am
Rheinfall SH
Tel. +41 52 674 07 07
Fax +41 52 674 07 08
info@weidmueller.ch
www.weidmueller.ch
- CL Chile**
ATS-INTECH
Maria Luisa Santander 0475
Santiago
Providencia 7500859
Tel. +56 2 341 1271
Fax +56 2 341 1275
felipe@atsintech.com
www.atsintech.com

CPI CHILE LTDA
Av. Presidente Frei Montalva
6001, 47 complejo el cortijo
Santiago - Conchalí
Tel. +562 963 8440
Fax +562 963 8440
cpi@cpichile.cl
www.cpicichile.cl
- CN China**
Weidmüller Interface
(Shanghai) Co. Ltd.
100 Yutong Road
25 F, BM Intercontinental
Business Center
200070 Shanghai
Tel. +86 21-22195008
Fax +86 21-22195009
customer.hotline@weidmueller.com.cn
www.cnweidmuller.com
- CO Colombia**
Automatización Avanzada
S. A.
Carrera 97 No., 24 c - 23
Bodega 4
110911 Bogotá-D.C.
Tel. +57 (1) 547-8510
Fax +57 (1) 422-3044
comercial@automatizacionavanzada.com
www.automatizacionavanzada.com
- CR Costa Rica**
ELVATRON S. A.
la Uruca 400 Norte Banco
Costa Rica
San Jose Costa Rica
Tel. +506 2961-060
Fax +506 5200-609
dirk.haase@elvatron.com
www.elvatron.com
- CZ Czech Republic**
Weidmüller s.r.o.
Lomnického 5/1705
140 00 Praha 4
Tel. +420 244 001 400
Fax +420 244 001 499
office@weidmueller.cz
www.weidmueller.cz
- DE Germany**
Weidmüller GmbH & Co. KG
Olmstraße 9
32758 Detmold
Postfach 30 54
32720 Detmold
Tel. +49 5231 1428-0
Fax +49 5231 1428-116
weidmueller@weidmueller.de
www.weidmueller.de
- DK Denmark**
Weidmüller Danmark
Vallensbækvej 18A
2605 Brøndby
Tel. +45 27747800
kundeservice@weidmuller.dk
www.weidmuller.dk
- EC Ecuador**
Elsystec S. A., Electricidad
Sistemas y Tecnología
Vasco de Contreras N35-25 1
y Mañosa
Quito - Pichincha
Tel. +593 22456510
Fax +593 22456755
Elsystec@uio.satnet.net
- EE Estonia**
Please contact
our Representative Office
Weidmüller Interface GmbH
& Co. KG
Latvia

or
Soots Interface OÜ
Pärnu mnt 142
11317 Tallinn
Tel. +372 609 6933
Fax +372 609 6933
info@sootsinterface.ee
www.sootsinterface.ee
- EG Egypt**
Standard Electric (OMEGA)
87, Mohamed Farid Street
Heliopolis
Cairo
Tel. +202 26229000
Fax +202 26221555
stdelec@rite.com
- ES Spain**
Weidmüller, S. A.
Narcis Monturiol 11-13, Pol.
Ind. Sudoeste
8960 Sant Just
Desvern - Barcelona
Tel. +34 934 803 386
Fax +34 933 718 055
weidmuller@weidmuller.es
www.weidmuller.es
- FI Finland**
Weidmüller Suomi,
Weidmüller Aktiebolagetin
sivillike
Koy Plaza Vivace
Ayritie 6C
FI 1510 Vantaa
Tel. +358 20 7351300
Fax +358 800 114 667
asiakaspalvelu@weidmuller.fi
www.weidmuller.fi
- FR France**
Weidmüller E. U. R. L.
12, Chaussée Jules César
BP 263 Osny
95523 Cergy-Pontoise Cedex
Tel. +33 1 34 24 55 00
Fax +33 1 34 24 55 01
mail@weidmuller.fr
- GB Great Britain**
Weidmüller Ltd.
Klippon House
Centurion Court Office Park,
Meridian East, Meridian
Business Park
Leicester
LE19 1TP
Tel. +44 116 282 3470
Fax +44 116 289 3582
marketing@weidmuller.co.uk
www.weidmuller.co.uk
- GE Georgia**
Please contact
our Representative Office
Rashad Mahmudov
Azerbaijan.
- GR Greece**
G.A. Solutions
Ippokratous 11 Metamorfois
144 52 Athen
Tel. +30 210 2823233
Fax +30 210 2823233
info@weidmuller.gr
www.weidmuller.gr
- GT Guatemala**
Prestelectro, Prestegard
Electro. S.A.
Avenida Petapa 44-22,
Zona 12
Guatemala City
Tel. +502 2442-3346
Fax +502 2476-8945
ventas@prestelectro.com
- HK Hong Kong**
Weidmüller (Hong Kong)
Limited Co. Ltd.
Unit 1617, Metropolis Tower
No. 10 Metropolis Drive,
Hungghom, Kowloon
Tel. +852 3154 8088
Fax +852 31548099
Info-hk@weidmueller.com.hk
- HR Croatia**
ElektroPARTNER d.o.o.
Slavonska avenija 24/6
HR-10000 Zagreb
Tel. +385 (1) 6184 793
Fax +385 (1) 6184 795
elektropartner@zg-t.com.hr
www.elektropartner.hr
- HU Hungary**
Weidmüller Kereskedelmi Kft.
Budapest
Gubacsi út 6.
1097
Tel. +36 1 382 7700
Fax +36 1 382 7701
info@weidmueller.hu
www.weidmueller.hu
- ID Indonesia**
PT. Nego Electrindo
Ruko Mega Grosir Cempaka
Mas Blok I No. 20 - 22
Jakarta 10640
Tel. +62 21 42882255
Fax +62 21 42882266
sales@negoelectrindo.co.id
- IE Ireland**
Please contact
Weidmüller Ltd.
Great Britain
- IL Israel**
A. U. Shay Ltd.
23/25, Embar Street
49222 Petach-Tikva
P.O. Box 1 00 49
49222 Petach-Tikva
Tel. +972 3-923-3601
Fax +972 3-923-4601
shay@uriel-shay.com
www.uriel-shay.com

ATEKA Ltd.
4, Ha Tavor lane Industrial
area Segula
49691 Petach-Tikva
P.O. Box 4710
Petach-Tikva
Tel. +972 73-200-1311
Fax +972 3-924 4245
marketing@ateka.co.il
www.ateka.co.il
- IN India**
Representative Office
Weidmüller Electronics India
Pvt. Ltd.
12th Lane North Avenue, Opp
Joggers Park,
Kalyani Nagar, Pune
411 006
Tel. +91 20-41290090
Nitish.Rajan@weidmueller.de
www.weidmueller.com
- IS Iceland**
Samey Automation Center
Lyngas 13
210 Garoabaer
Tel. +354 5 10 5200
Fax +354 5 10 5201
Samey@samey.is
www.samey.is
- IT Italy**
Weidmüller S. r.l.
Via Albert Einstein 4
20092 Cinisello
Balsamo Milano
Tel. +39 02 660681
Fax +39 02 6124945
weidmuller@weidmuller.it
www.weidmuller.it
- JM Jamaica**
Please contact
W Interconnections Inc.
United States
- JO Jordan**
Trans Jordan for Electro
PO Box 33 06 07
Amman
Tel. +962 6 533 2020
Fax +962 6 533 5800
transjordan@batelco.jo
- JP Japan**
Nihon Weidmüller Co. Ltd.
Sphere Tower Tennoz 2-2-8
Higashi-Shinagawa,
Shinagawa-ku
Tokyo
140-0002
Tel. +81 3 6711 5300
Fax +81 3 6711 5333
weidmullerjapan@weidmuller.co.jp
www.weidmuller.co.jp
- KE Kenya**
Please contact
Phambili Interface
South Africa
- KR Korea**
Weidmüller Korea Co. Ltd.
9th floor, Wonbang B/D
Samsseong 2-Dong, Gangnam-Gu
Seoul 143-42
Tel. +82 2-516-0003
Fax +82 2-516-0090
info@weidmuller.co.kr
www.weidmuller.co.kr
- KZ Kazakhstan**
Please contact
OOO Weidmüller
Russia
- LT Lithuania**
Please contact
our Representative Office
Weidmüller Interface GmbH
& Co. KG
Latvia

or
ELEKTROS IRANGA
Tinklu g. 29 a
LT-5319 Panevezys
Tel. +370 (45) 582 828
Fax +370 (45) 582 727
info@eliranga.lt
- LU Luxembourg**
Please contact
Weidmüller Benelux B. V.
Netherlands



You can find all Weidmüller addresses and your local contact on the internet at: www.weidmueller.com/countries

Sales company 

Representation abroad 

without representation abroad 

Let's connect.

- LV Latvia**
SIA Abi4
Daugavgrivas 31b
Rīga, LV-1007
Tel. +371 674 70999
Fax +371 674 65637
abi_4@tvnet.lv

Representative Office
Weidmüller Interface GmbH & Co. KG
Udens str. 12-118
Rīga, LV-1007
Tel. +371 29254766
Fax +371 676 24562
lgonis.rudaks@weidmueller.com
www.weidmueller.com
- MD Moldova**
BERHORD A & D srl
79/1, str. Milescu Spartaru
MD-2075 Chisinau
Moldova
Tel. +373 (22) 815002
Fax +373 (22) 815007
atiuleanu@berhord.com
www.ad.berhord.com
- ME Montenegro**
Please contact our Representative Office
Weidmüller Interface GmbH & Co. KG
Serbia.
- MG Madagascar**
Please contact
Phambili Interface
South Africa
- MK Macedonia**
Please contact our Representative Office
Weidmüller Interface GmbH & Co. KG
Serbia

or
ELEKTRO - SMK dool
UL. III Makedonska brigada
b.b.
1000 Skopje
Tel. +389 22460295
Fax +389 22460298
Elektro-smk@telekabel.net.mk
- MT Malta**
E. S. S., Electrical Supplies & Services Ltd.
San Gwakklin Road
Mrieהל

Tel. +356 21255777
Fax +356 21255999
robert.agiuss@ess.com.mt
- MU Mauritius**
Mubelo Electrical Ltd.
Office 26, Gateway building,
St Jean Road
Quatre Bornes
Mauritius
Tel. +230 4670989
Fax +230 4654051
richard.mubelo@orange.mu
- MW Malawi**
Please contact
Phambili Interface
South Africa
- MX Mexico**
W Interconnections S. A.
DE C. V.
Bvd. Hermanos Serdán 698,
Col. San Rafael Oriente
72029 Puebla
Tel. +52 (222) 268 6227
Fax +52 (222) 286 6242
clientes@weidmueller.com.mx
- MY Malaysia**
Connect Plus Technology
Sdn Bhd
No. 43, Jalan PJS 11/22,
Bandar Sunway
46150 Petaling Jaya
Selangor Darul Ehsan
Tel. +60 3 5633 7363
Fax +60 3 5633 6562
paul@cpotech.com.my
www.cpotech.com.my
- MZ Mozambique**
Please contact
Phambili Interface
South Africa
- NA Namibia**
Please contact
Phambili Interface
South Africa
- NG Nigeria**
Please contact
Phambili Interface
South Africa
- NL Netherlands**
Weidmüller Benelux B. V.
Franciscusweg 221
1216 SE Hilversum
P.O. Box 1505
1200 BM Hilversum
Tel. +31 35 626 12 61
Fax +31 35 623 20 44
info@weidmuller.nl
www.weidmuller.nl
- NO Norway**
Sivilingeniør J.F. Knudtzen AS
Billingstadsletta 97
1396 Billingstad
PO Box 160
1378 Nesbru
Tel. +47 66 98 33 50
Fax +47 66 98 09 55
firmapost@jfkudtzen.no
www.jfkudtzen.no
- NZ New Zealand**
Cuthbert S. Stewart Ltd.
27 Te Puni Street
Petone
PO Box 38496
Wellington Mail Centre 5054
Tel. (04) 568 6156
Fax (04) 568 6056
csl@cuthbertstewart.co.nz

Cuthbert S. Stewart Ltd
4 Fred Thomas Drive
Aon Building, Ground Floor,
South Entry
Takapuna
PO Box 100 338
North Shore City 745
Tel. (09) 489 1751
Fax (09) 489 1752
cslak@cuthbertstewart.co.nz
- OM Oman**
DAN INTERNATIONAL LLC.
Ghala St. 111
BP 2901
Seeb
Tel. +968 5036 77
Fax +968 5037 55
yedu@danintl.com
- PE Peru**
IMPEXINCA S.A.C.
Calle Ortiz de Zevallos No.
105, Urb. San Antonio
18
Lima, Miraflores
Tel. +51 1 447 5608
info@impexinca.pe
www.impexinca.pe

J & W CIA. S. A.
Calle 6 Mz. D Lte. 23, Urb.
Ind. Grimanesa
1
Callao
Tel. +51 1 572 2539
Fax +51 1 572 0152
contacto@jwcia.com
www.jwcia.com
- PH Philippines**
Enclosure Systems Specialists
Inc.
2276 Don Chino Roces
Avenue Extension
Room 103/105 Narra Building
1231 Makati City
Tel. +63 2 813 8580
Fax +63 2 813 8596
sales_encsys@pltdsl.net
www.enclosuresystemsph.com
- PK Pakistan**
Automation Controls (Pak)
Apartment No. 33 C III,
Chenab Block, Allama Iqbal
Town
Lahore
Tel. +92 42 37809948
Fax +92 42 37809950
nadeem@acpak.com.pk
www.acpak.com.pk
- PL Poland**
Weidmüller Sp. z o. o.
ul. Ogrodowa 58
00-876 Warszawa
Tel. +48 22 510 09 40
Fax +48 22 510 09 41
biuro@weidmuller.com.pl
www.weidmuller.pl
- PR Puerto Rico**
Please contact
W Interconnections Inc.
United States
- PT Portugal**
Weidmüller Sistemas de
Interface S. A.
Estrada Outeiro Polima, R.
Augusto Dias da Silva, Lote
B - Esct. 2
São Domingos de Rana
2785-515 Abóboda
Tel. +351 214 459 191
Fax +351 214 455 871
weidmuller@weidmuller.pt
www.weidmuller.pt
- PY Paraguay**
Please contact
CPI SA
Argentina
- RO Romania**
Representative Office
Weidmüller Interface GmbH
& Co. KG
Ionescu Crum Street, No.
1, 1st Tower, 1st Floor,
Office 4
500446 Brasov - Brasov
Business Park
Tel. +40 (268) 446 222
Fax +40 (268) 446 224
claudiu.totea@weidmueller.com
www.weidmueller.com
- RS Serbia**
Representative Office
Weidmüller Interface GmbH
& Co. KG
Ustanicka 189, III sprat
Iokal 7a
11050 Beograd
Tel. +381 11 2885274
Fax +381 11 2885274
zoran.rabrenovic@weidmueller.com
- RU Russia**
OOO Weidmüller
Warshavskoye highway, 25
A, bld. 6
Moskau
117105
Tel. +7 (495) 771-69-40
Fax +7 (495) 771-69-41
Info@weidmuller.ru
www.weidmuller.ru
- SA Saudi Arabia**
Please contact
Weidmüller Middle East FZE
United Arab Emirates
- SE Sweden**
Weidmüller AB
Axel Danielssons väg 271
BOX 31025
SE-200 49 Malmö
Tel. +46 77-143 00 44
Fax +46 40-37 48 60
info@weidmuller.se
www.weidmuller.se
- SG Singapore**
Weidmüller Pte. Ltd.
70 Bendemeer Road
04-03 Luzerne Building
Singapore 339940
Tel. +65 6841 5311
Fax +65 6841 5377
info@weidmuller.com.sg
www.weidmuller.com.sg
- SI Slovenia**
Elektrospoji d. o. o.
Stegne 27
SI- 1000 Ljubljana
Osrednjeslovenska
Tel. +386 1 511 3810
Fax +386 1 511 1604
info@elektrospoji.si
www.elektrospoji.si
- SK Slovakia**
ELEKTRIS s.r.o.
Elektrárnská 1
831 04 Bratislava
Tel. +421 2/4920 0113
Fax +421 2/4920 0119
bratislava@elektris.sk
- SV El Salvador**
Prestegard Electro
11 Avenida Norte No. 240
Edificio Salazar No. 2
San Salvador
Tel. +503 2271 1690
Fax +503 2221 3851
prestegard@navegante.com.sv
- SY Syria**
Please contact
Weidmüller Middle East FZE
United Arab Emirates
- SZ Swaziland**
Please contact
Phambili Interface
South Africa
- TH Thailand**
Pisanu Engineering Co. Ltd.
Kwang Dingaeng, Khet
Dingaeng
800/2 Soi Trakulsuk, Asoke-
dindaeng Road
Dindaeng, Bangkok
10400
Tel. +66 2 248 2896
Fax +66 2 642 9220
ecsales@pisanu.co.th
www.pisanu.co.th

Representative Office
Weidmüller Pte. Ltd.
37/F, Sathorn Square Building
98 North Sathorn Road
Bangkok, Silom Bangrak
10500
Tel. +66 2 105 6300
Fax +662 105 6301
info@weidmuller.com.sg
- TN Tunisia**
Please contact
Weidmüller E. U. R. L.
France
- TR Turkey**
Weidmüller Elektronik Ticaret
Ltd. Sirketi
Kavacık Mah. Orhan Veli Kanık
Caddesi 9/1
34810 Beykoz / Istanbul
Tel. +90 (216) 537 10 70
Fax +90 (216) 537 10 77
info@weidmuller.com.tr
www.weidmuller.com.tr
- TW Taiwan**
Weidmüller (Hong Kong)
Limited
No. 3, Lane 89, ChungYang
N. Rd.
24148 SanChuang City,
Taipei
Tel. +886 921 949 751
roy.lin@weidmueller.com.hk
- TZ Tanzania**
Please contact
Phambili Interface
South Africa
- UA Ukraine**
LLC WM UKRAINE
Levanevskogo str. 6
Kiev
3058
Tel. +38 044 490 32 48
Fax +38 044 490 32 49
info@wm-ua.com.ua
wm-ua.com.ua/

Representative Office
Weidmüller Interface GmbH
& Co. KG
Z. office 303
7-D, Zdobunivska str.
Kiev, 2081
Mobile +38 050 440 25 24
info.ua@weidmueller.com
- US United States**
W Interconnections Inc.
821 Southlake Boulevard
Richmond Virginia 23236
Tel. +1 (804) 794-2877
Fax +1 (804) 379-2593
info@weidmuller.com
www.weidmuller.com
- UZ Republic of Uzbekistan**
Please contact
OOO Weidmüller
Russia
- VN Vietnam**
AUMI Industrial Equipment &
Automation Company Limited
E1, La Thanh Hotel
218 Doi Can Street
Lieu Giai Ward, Ba Dinh
District
Hanoi City
Tel. +84 4 37628601
Fax +84 4 62661391
aumi@aumi.com.vn
www.aumi.com.vn

Representative Office
Weidmüller Pte. Ltd.
Level 16 Saigon Tower
Building
29 Le Duan Street
District 1
Ho Chi Minh
Tel. +848 3520 7717
Fax +848 3520 7604
info@weidmuller.com.sg
- ZA South Africa**
Phambili Interface
PO Box 193
1609 Johannesburg, Edenvale
5 Bundo Road, Sebenza
1610 Johannesburg
Tel. +27 (11) 4521930
Fax +27 (11) 4526455
info@weidmuller.co.za
www.weidmuller.co.za
- ZM Zambia**
Please contact
Phambili Interface
South Africa
- ZW Zimbabwe**
Please contact
Phambili Interface
South Africa

