

OMNIMATE Signal - series BL/SL 5.08 SLDF 5.08 L/F 10 SN OR BX

Weidmüller Interface GmbH & Co. KG
Klingenbergstraße 16
D-32758 Detmold
Germany
Fon: +49 5231 14-0
Fax: +49 5231 14-292083
www.weidmueller.com

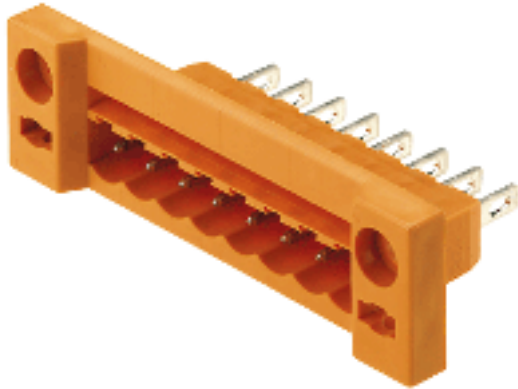

Male connector for through-panel mounting with optional locking function. Internal connection as flat-blade or solder connection. These male connectors provide space for labelling and can be coded.

- 400 V (IEC) / 300 V (UL)
- 15 A (IEC) / 10 A (UL)

General ordering data

Type	SLDF 5.08 L/F 10 SN OR BX
Order No.	1599210000
Version	PCB plug-in connector, male header, 5.08 mm, No. of poles: 10, 180°, Flat-blade connection, Solder connection, Box
GTIN (EAN)	4008190065522
Qty.	50 pc(s).
Product data	IEC: 400 V / 15 A UL: 300 V / 10 A
Packaging	Box

OMNIMATE Signal - series BL/SL 5.08
SLDF 5.08 L/F 10 SN OR BX

Weidmüller Interface GmbH & Co. KG
 Klingenbergstraße 16
 D-32758 Detmold
 Germany
 Fon: +49 5231 14-0
 Fax: +49 5231 14-292083
 www.weidmueller.com

Technical data**Dimensions and weights**

Net weight	11.3 g
------------	--------

System parameters

Product family	OMNIMATE Signal - series BL/SL 5.08	Wire connection method	Flat-blade connection, Solder connection
Conductor outlet direction	180°	Pitch in mm (P)	5.08 mm
Pitch in inches (P)	0.2 inch	No. of poles	10
L1 in mm	45.72 mm	L1 in inches	1.8 inch

Material data

Insulating material	PBT	Colour	Orange
Colour chart (similar)	RAL 2000	UL 94 flammability rating	V-0
CTI	≥ 200	Contact material	CuSn
Contact surface	tinned	Operating temperature, min.	-50 °C
Operating temperature, max.	100 °C	Temperature range, installation, min.	-25 °C
Temperature range, installation, max.	100 °C		

Rating data acc. to IEC 60664-1 / IEC 61984

Rated current, min. no. of poles (Tu=20°C)	15 A	Rated current, number of poles (Tu=40°C), min	13 A
Rated voltage for surge voltage class / pollution degree II/2	400 V	Rated voltage for surge voltage class / pollution degree III/2	320 V
Rated voltage for surge voltage class / pollution degree III/3	250 V	Rated impulse voltage for surge voltage class/ pollution degree II/2	4 kV
Rated impulse voltage for surge voltage class/ pollution degree III/2	4 kV	Rated impulse voltage for surge voltage class/ contamination degree III/3	4 kV

CSA rating data

Institute (CSA)		Certificate No. (CSA)	200039-1121690
Rated voltage (Use group B)	300 V	Rated current (use group B)	10 A
Rated voltage (use group D)	300 V	Rated current (use group D)	10 A

UL 1059 rating data

Institute (UR)		Certificate No. (UR)	E60693
Rated voltage (use group B)	300 V	Rated current (use group B)	10 A
Rated voltage (use group D)	300 V	Rated current (use group D)	10 A

Classifications

ETIM 3.0	EC001284	UNSPSC	30-21-18-10
eClass 5.1	27-26-07-04	eClass 6.2	27-26-07-04
eClass 7.1	27-44-04-02		

Data sheet**OMNIMATE Signal - series BL/SL 5.08
SLDF 5.08 L/F 10 SN OR BX**

Weidmüller Interface GmbH & Co. KG
Klingenbergstraße 16
D-32758 Detmold
Germany
Fon: +49 5231 14-0
Fax: +49 5231 14-292083
www.weidmueller.com

Technical data**Notes**

Notes

- Additional colours on request
- Rated current related to rated cross-section & min. No. of poles.
- Connectable cables with solder connection solid and flexible up to 2.5 mm² with insulating/shrink-wrap sleeve or from 2.8 mm flat blade receptacles with insulated sleeves acc. to DIN IEC 760
- P on drawing = pitch
- Rated data refer only to the component itself. Clearance and creepage distances to other components are to be designed in accordance with the relevant application standards.

Approvals

Approvals



ROHS

Conform

Data sheet

**OMNIMATE Signal - series BL/SL 5.08
SLDF 5.08 L/F 10 SN OR BX**

Weidmüller Interface GmbH & Co. KG
 Klingenbergstraße 16
 D-32758 Detmold
 Germany
 Fon: +49 5231 14-0
 Fax: +49 5231 14-292083
 www.weidmueller.com

Drawings

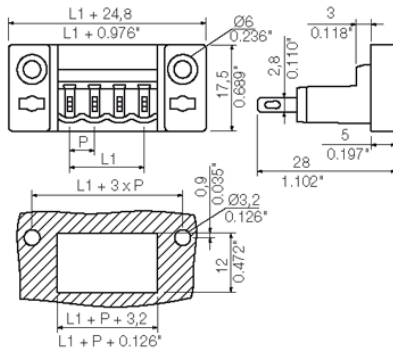

OMNIMATE Signal - series BL/SL 5.08 SLDF 5.08 L/F 10 SN OR BX

Weidmüller Interface GmbH & Co. KG
 Klingenbergstraße 16
 D-32758 Detmold
 Germany
 Fon: +49 5231 14-0
 Fax: +49 5231 14-292083
 www.weidmueller.com

Mating connector (conditionally pluggable)

BLZ 5.08/180B



Female plugs with clamping-yoke screw for wire connection with straight (180°) outlet direction. The female plugs provide space for labelling and can be coded.

- 0.2 - 2.5 mm² (IEC) / 26 - 12 AWG (UL)
- 400 V (IEC) / 300 V (UL)
- 19 A (IEC) / 15 A (UL)

General ordering data

Delivery status	Available until	Type	Order No.	Version	GTIN (EAN)	Qty.
This article will no longer be available in the future.	2015-12-31T00:00:00+01:00	BLZ 5.08/10/180B SN OR BX	1529560000	PCB plug-in connector, female plug, 5.08 mm, No. of poles: 10, 180°, Clamping yoke connection, Clamping range, rated connection, max.: 3.31 mm ² , Box	4008190158224	50 pc(s)
	2009-12-31T00:00:00+01:00	BLZ 5.08/10/180B SN BK BX	1529510000	PCB plug-in connector, female plug, 5.08 mm, No. of poles: 10, 180°, Clamping yoke connection, Clamping range, rated connection, max.: 3.31 mm ² , Box	400819011364350	50 pc(s)

OMNIMATE Signal - series BL/SL 5.08 SLDF 5.08 L/F 10 SN OR BX

Weidmüller Interface GmbH & Co. KG
 Klingenbergstraße 16
 D-32758 Detmold
 Germany
 Fon: +49 5231 14-0
 Fax: +49 5231 14-292083
 www.weidmueller.com

Mating connector (conditionally pluggable)

ZZ_Varianten



Female plugs with clamping-yoke screw for wire connection with straight (180°) outlet direction. The female plugs provide space for labelling and can be coded.

- 0.2 - 2.5 mm² (IEC) / 26 - 12 AWG (UL)
- 400 V (IEC) / 300 V (UL)
- 19 A (IEC) / 15 A (UL)

General ordering data

Type	Order No.	Version	GTIN (EAN)	Qty.	Product data	Packaging
BLZ 5.08/10/180B SN DKGX BX	1529550000	PCB plug-in connector, female plug, 5.08 mm, No. of poles: 10, 180°, Clamping yoke connection, Clamping range, rated connection, max.: 3.31 mm ² , Box	4008190290269	50 pc(s).	IEC: 400 V / 19 A / 0.2 - 2.5 mm ² UL: 300 V / 15 A / AWG 26 - AWG 12	Box

BLZF 5.08/180B



Female plugs with tension-clamp wire connection system, straight 180° outlet direction. The female plugs provide space for labelling and can be coded.

- 0.2 - 2.5 mm² (IEC) / 26 - 12 AWG (UL)
- 400 V (IEC) / 300 V (UL)
- 17 A (IEC) / 15 A (UL)

General ordering data

Delivery status Available until	Type	Order No.	Version	GTIN (EAN)	Qty.
This article will no longer be available in the future.	BLZF 5.08/10/180B SN OR BX	1708380000	PCB plug-in connector, female plug, 5.08 mm, No. of poles: 10, 180°, Tension clamp connection, Clamping range, rated connection, max.: 3.31 mm ² , Box	4008190316402	30 pc(s).

Data sheet

**OMNIMATE Signal - series BL/SL 5.08
SLDF 5.08 L/F 10 SN OR BX**

Weidmüller Interface GmbH & Co. KG
Klingenbergstraße 16
D-32758 Detmold
Germany
Fon: +49 5231 14-0
Fax: +49 5231 14-292083
www.weidmueller.com

Mating connector (conditionally pluggable)

BLZ 5.08/90B



Female plugs with clamping-yoke screw connection. The female plugs provide space for labelling and can be coded.

- 0.2 - 2.5 mm² (IEC) / 26 - 12 AWG (UL)
- 400 V (IEC) / 300 V (UL)
- 15 A (IEC) / 10 A (UL)

General ordering data

Delivery status Available until	Type	Order No.	Version	GTIN (EAN)	Qty.
This article will no longer be available in the future.	BLZ 5.08/10/90B SN OR BX	1555860000	PCB plug-in connector, female plug, 5.08 mm, No. of poles: 10, 90°, Clamping yoke connection, Clamping range, rated connection, max.: 3.31 mm ² , Box	4008190158866	30 pc(s).

BLL 5.08/180B



Female header for PCB mounting. The solder pin length is optimised for wave flow soldering.

- 400 V (IEC) / 300 V (UL)
- 23 A (IEC) / 15 A (UL)

General ordering data

Type	Order No.	Version	GTIN (EAN)	Qty.	Product data	Packaging
BLL 5.08/10/180B 3.2SN OR BX	1682810000	PCB plug-in connector, female header, Dovetails for fixing blocks, Solder connection, 5.08 mm, No. of poles: 10, 180°, Solder pin length (l): 3.2 mm, tinned, Orange, Box	4008190474577	30 pc(s).	IEC: 400 V / 23 A UL: 300 V / 15 A	Box

**OMNIMATE Signal - series BL/SL 5.08
SLDF 5.08 L/F 10 SN OR BX**

Weidmüller Interface GmbH & Co. KG
Klingenbergstraße 16
D-32758 Detmold
Germany
Fon: +49 5231 14-0
Fax: +49 5231 14-292083
www.weidmueller.com

Mating connector (conditionally pluggable)
BLDT 5.08B

Female plugs with two clamping-yoke screw connections per pole for wire connections with 90° and 270° outlet directions. The female plugs provide space for labelling and can be coded.

- 0.2 - 2.5 mm² (IEC) / 26 - 12 AWG (UL)
- 400 V (IEC) / 300 V (UL)
- 14 A (IEC) / 10 A (UL)

General ordering data

Type	Order No.	Version	GTIN (EAN)	Qty.	Product data	Packaging
BLDT 5.08/10/-B SN OR BX	1651820000	PCB plug-in connector, female plug, 5.08 mm, No. of poles: 10, 180°, TOP connection, Clamping range, rated connection, max.: 3.31 mm ² , Box	4008190400507	25 pc(s).	IEC: 400 V / 14 A / 0.2 - 2.5 mm ² UL: 300 V / 10 A / AWG 26 - AWG 12	Box
2014-05-20 BLDT 5.08/10/-B SN BK BX	1673860000			4008190435592	50 pc(s).	IEC: 400 V / 14 A / 0.2 - 2.5 mm ² UL: 300 V / 10 A / AWG 26 - AWG 12

OMNIMATE Signal - series BL/SL 5.08 SLDF 5.08 L/F 10 SN OR BX

Weidmüller Interface GmbH & Co. KG
 Klingenbergstraße 16
 D-32758 Detmold
 Germany
 Fon: +49 5231 14-0
 Fax: +49 5231 14-292083
 www.weidmueller.com

Mating connector (conditionally pluggable)

BLZ 5.08/225B



Female plugs with clamping-yoke screw for wire connection with 225° outlet direction. The female plugs provide space for labelling and can be coded.

- 0.2 - 2.5 mm² (IEC) / 26 - 12 AWG (UL)
- 400 V (IEC) / 300 V (UL)
- 16.5 A (IEC) / 10 A (UL)

General ordering data

Delivery status	Available until	Type	Order No.	Version	GTIN (EAN)	Qty.
This article will no longer be available in the future.	2015-12-31T00:00:00+01:00	BLZ 5.08/10/225B SN OR BX	1742180000	PCB plug-in connector, female plug, 5.08 mm, No. of poles: 10, 225°, Clamping yoke connection, Clamping range, rated connection, max.: 3.31 mm ² , Box	4008190247492	30 pc(s).
	2011-09-30T00:00:00+02:00	BLZ 5.08/10/225B SN BK BX	1742410000	PCB plug-in connector, female plug, 5.08 mm, No. of poles: 10, 225°, Clamping yoke connection, Clamping range, rated connection, max.: 3.31 mm ² , Box	4032248049820	30 pc(s). IEC: 400 V / 16.5 A / 0.2 - 2.5 mm ² UL: 300 V / 10 A / 26 AWG - 12

Data sheet

**OMNIMATE Signal - series BL/SL 5.08
SLDF 5.08 L/F 10 SN OR BX**

Weidmüller Interface GmbH & Co. KG
Klingenbergstraße 16
D-32758 Detmold
Germany
Fon: +49 5231 14-0
Fax: +49 5231 14-292083
www.weidmueller.com

Mating connector (conditionally pluggable)

BLZ 5.08/270B



Female plugs with clamping-yoke screw connection. The female plugs provide space for labelling and can be coded.

- 0.2 - 2.5 mm² (IEC) / 26 - 12 AWG (UL)
- 400 V (IEC) / 300 V (UL)
- 15 A (IEC) / 10 A (UL)

General ordering data

Available until	Type	Order No.	Version	GTIN (EAN)	Qty.	Product data
2009-12-31	BLZ 5.08/10/270B SN BK BX	1560410000	PCB plug-in connector, female plug, 5.08 mm, No. of poles: 10, 270°, Clamping yoke connection, Clamping range, rated connection, max.: 3.31 mm ² , Box	4008190269753	30 pc(s).	IEC: 400 V / 15 A / 0.2 - 2.5 mm ² UL: 300 V / 10 A / 26 AWG - 12 AWG
This article will no longer be available in the future.	2015-12-31	BLZ 5.08/10/270B SN OR BX	1560460000	4008190156947	30 pc(s).	

OMNIMATE Signal - series BL/SL 5.08 SLDF 5.08 L/F 10 SN OR BX

Weidmüller Interface GmbH & Co. KG
 Klingenbergstraße 16
 D-32758 Detmold
 Germany
 Fon: +49 5231 14-0
 Fax: +49 5231 14-292083
 www.weidmueller.com

Mating connector (conditionally pluggable)

BLZF 5.08/270B



Female plugs with tension-clamp wire connection system. The female plugs provide space for labelling and can be coded.

- 0.2 - 2.5 mm² (IEC) / 26 - 12 AWG (UL)
- 400 V (IEC) / 300 V (UL)
- 16.5 A (IEC) / 10 A (UL)

General ordering data

Available until	Type	Order No.	Version	GTIN (EAN)	Qty.	Product data
2011-09-30	BLZF 5.08/270B SN BK BX	1672710000	PCB plug-in connector, female plug, 5.08 mm, No. of poles: 10, 270°, Tension clamp connection, Clamping range, rated connection, max.: 3.31 mm ² , Box	400819043442730	30 pc(s).	IEC: 400 V / 16.5 A / 0.2 - 2.5 mm ² UL: 300 V / 10 A / 26 AWG - 12 AWG
This article will no longer be available in the future.	BLZF 5.08/10/270B SN OR BX	1672480000	PCB plug-in connector, female plug, 5.08 mm, No. of poles: 10, 270°, Tension clamp connection, Clamping range, rated connection, max.: 3.31 mm ² , Box	4008190434199	30 pc(s).	

**OMNIMATE Signal - series BL/SL 5.08
SLDF 5.08 L/F 10 SN OR BX**

Weidmüller Interface GmbH & Co. KG
Klingenbergstraße 16
D-32758 Detmold
Germany
Fon: +49 5231 14-0
Fax: +49 5231 14-292083
www.weidmueller.com

Mating connector (conditionally pluggable)
BLZP 5.08/225B SN

Clamping-yoke wire connection with right-angled (90° or 270°) or angled (225°) outlet direction. The female plugs provide space for labelling and can be coded. Can be fastened with flange or release latch. They also feature the integrated plus/minus screw, protection from under insertion of wire, and are delivered with open clamping yoke.

- 0.2 – 2.5 mm² (IEC) / 26-12 AWG (UL)
- 400 V (IEC) / 300 V (UL)
- 17.5 A (IEC) / 10 A (UL)

General ordering data

Type	Order No.	Version	GTIN (EAN)	Qty.	Product data	Packaging
BLZP 5.08HC/10/225B SN BK BX	1946060000	PCB plug-in connector, female plug, 5.08 mm, No. of poles: 10, 225°, Clamping yoke connection, Clamping range, rated connection, max.: 4 mm ² , Box	4032248621590	30 pc(s).	IEC: 400 V / 17.5 A / 0.2 - 4 mm ² UL: 300 V / 15 A / AWG 30 - AWG 12	Box
BLZP 5.08HC/10/225B SN OR BX	1945830000	PCB plug-in connector, female plug, 5.08 mm, No. of poles: 10, 225°, Clamping yoke connection, Clamping range, rated connection, max.: 4 mm ² , Box	4032248621309	30 pc(s).	IEC: 400 V / 17.5 A / 0.2 - 4 mm ² UL: 300 V / 15 A / AWG 30 - AWG 12	Box

BLC 5.08BR

Female plugs with crimp wire connection system. The female plugs provide space for labelling and can be coded.

- 0.25 - 2.5 mm² (IEC) / 26 - 14 AWG (UL)
- 400 V (IEC) / 300 V (UL)
- 21 A (IEC) / 10 A (UL)

General ordering data

Available until	Type	Order No.	Version	GTIN (EAN)	Qty.	Product data
2014-05-20	BLZP 5.08/225B SN BK BX	1712190000	PCB plug-in connector, female plug, 5.08 mm, No. of poles: 10, 180°, Crimp connection, Clamping range, rated connection,	4008190935207	50 pc(s).	IEC: 400 V / 21 A UL: 300 V / 10

Data sheet

**OMNIMATE Signal - series BL/SL 5.08
SLDF 5.08 L/F 10 SN OR BX**

Weidmüller Interface GmbH & Co. KG
Klingenbergstraße 16
D-32758 Detmold
Germany
Fon: +49 5231 14-0
Fax: +49 5231 14-292083
www.weidmueller.com

Mating connector (conditionally pluggable)

			max.: 2.5 mm ² , Box		A / AWG 26 - AWG 14 Box
BLC 5.08/10/180BR OR BX	1649450000	PCB plug-in connector, female plug, 5.08 mm, No. of poles: 10, 180°, Crimp connection, Clamping range, rated connection, max.: 2.5 mm ² , Box	4008190294564 50 pc(s).	IEC: 400 V / 21 A UL: 300 V / 10 A / AWG 26 - AWG 14	

BLZF 5.08/90B



Female plugs with tension-clamp wire connection system. The female plugs provide space for labelling and can be coded.

- 0.2 - 2.5 mm² (IEC) / 26 - 12 AWG (UL)
- 400 V (IEC) / 300 V (UL)
- 16.5 A (IEC) / 10 A (UL)

General ordering data

Delivery status	Available until	Type	Order No.	Version	GTIN (EAN)	Qty.
This article will no longer be available in the future.	2015-12-31T00:00:00+01:00	BLZF 5.08/10/90B SN OR BX	1671330000	PCB plug-in connector, female plug, 5.08 mm, No. of poles: 10, 90°, Tension clamp connection, Clamping range, rated connection, max.: 3.31 mm ² , Box	4008190433031	30 pc(s).
	2011-09-30T00:00:00+01:00	BLZF 5.08/10/90B SN BK BX	1671560000	PCB plug-in connector, female plug, 5.08 mm, No. of poles: 10, 90°, Tension clamp connection, Clamping range, rated connection, max.: 3.31 mm ² , Box	4008190433260 30 pc(s).	IEC: 400 V / 16.5 A / 0.2 - 2.5 mm ² UL: 300 V / 10 A / AWG 26 -

**OMNIMATE Signal - series BL/SL 5.08
SLDF 5.08 L/F 10 SN OR BX**

Weidmüller Interface GmbH & Co. KG
Klingenbergstraße 16
D-32758 Detmold
Germany
Fon: +49 5231 14-0
Fax: +49 5231 14-292083
www.weidmueller.com

Mating connector (conditionally pluggable)

AWG

12

**OMNIMATE Signal - series BL/SL 5.08
SLDF 5.08 L/F 10 SN OR BX**

Weidmüller Interface GmbH & Co. KG
Klingenbergstraße 16
D-32758 Detmold
Germany
Fon: +49 5231 14-0
Fax: +49 5231 14-292083
www.weidmueller.com

Mating connector (fully pluggable)
BLZP 5.08/225 SN

Clamping-yoke wire connection with right-angled (90° or 270°) or angled (225°) outlet direction. The female plugs provide space for labelling and can be coded. Can be fastened with flange or release latch. They also feature the integrated plus/minus screw, protection from under insertion of wire, and are delivered with open clamping yoke.

- 0.2 – 2.5 mm² (IEC) / 26-12 AWG (UL)
- 400 V (IEC) / 300 V (UL)
- 17.5 A (IEC) / 10 A (UL)

General ordering data

Type	Order No.	Version	GTIN (EAN)	Qty.	Product data	Packaging
BLZP 5.08HC/10/225 SN OR BX	1946330000	PCB plug-in connector, female plug, 5.08 mm, No. of poles: 10, 225°, Clamping yoke connection, Clamping range, rated connection, max.: 4 mm ² , Box	4032248621903	36 pc(s).	IEC: 400 V / 17.5 A / 0.2 - 4 mm ² UL: 300 V / 15 A / AWG 30 - AWG 12	Box
BLZP 5.08HC/10/225 SN BK BX	1946640000	PCB plug-in connector, female plug, 5.08 mm, No. of poles: 10, 225°, Clamping yoke connection, Clamping range, rated connection, max.: 4 mm ² , Box	4032248622412	36 pc(s).	IEC: 400 V / 17.5 A / 0.2 - 4 mm ² UL: 300 V / 15 A / AWG 30 - AWG 12	Box

BLL 5.08/90

Female header for PCB mounting. The solder pin length is optimised for wave flow soldering.

- 400 V (IEC) / 300 V (UL)
- 23 A (IEC) / 15 A (UL)

General ordering data

Type	Order No.	Version	GTIN (EAN)	Qty.	Product data	Packaging
BLL 5.08/10/90 3.2 SN OR BX	1623020000	PCB plug-in connector, female header, closed side, Solder connection, 5.08 mm, No. of poles: 10, 90°, Solder pin length (l): 3.2 mm, tinned, Orange, Box	4008190194079	36 pc(s).	IEC: 400 V / 23 A UL: 300 V / 15 A	Box

**OMNIMATE Signal - series BL/SL 5.08
SLDF 5.08 L/F 10 SN OR BX**

Weidmüller Interface GmbH & Co. KG
Klingenbergstraße 16
D-32758 Detmold
Germany
Fon: +49 5231 14-0
Fax: +49 5231 14-292083
www.weidmuller.com

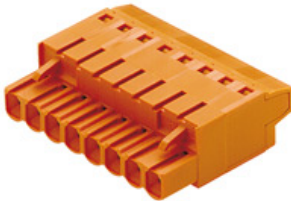
Mating connector (fully pluggable)
BLT 5.08

Female plugs with TOP screw system for connecting wires with straight 180° outlet direction. The female plugs provide space for labelling and can be coded.

- 0.2 - 2.5 mm² (IEC) / 26 - 14 AWG (UL)
- 400 V (IEC) / 300 V (UL)
- 17 A (IEC) / 10 A (UL)

General ordering data

Type	Order No.	Version	GTIN (EAN)	Qty.	Product data	Packaging
BLT 5.08HC/10/180 SN BK BX	1500310000	PCB plug-in connector, female plug, 5.08 mm, No. of poles: 10, 180°, TOP connection, Clamping range, rated connection, max.: 2.5 mm ² , Box	4008190861766	36 pc(s).	IEC: 400 V / 17 A / 0.2 - 2.5 mm ² UL: 300 V / 13 A / AWG 26 - AWG 14	Box
BLT 5.08HC/10/180 SN OR BX	1500360000	PCB plug-in connector, female plug, 5.08 mm, No. of poles: 10, 180°, TOP connection, Clamping range, rated connection, max.: 2.5 mm ² , Box	4008190103422	36 pc(s).	IEC: 400 V / 17 A / 0.2 - 2.5 mm ² UL: 300 V / 13 A / AWG 26 - AWG 14	Box

BLL 5.08/180

Female header for PCB mounting. The solder pin length is optimised for wave flow soldering.

- 400 V (IEC) / 300 V (UL)
- 23 A (IEC) / 15 A (UL)

General ordering data

Type	Order No.	Version	GTIN (EAN)	Qty.	Product data	Packaging
BLL 5.08/10/180 3.2 SN OR BX	1630790000	PCB plug-in connector, female header, closed side, Solder connection, 5.08 mm, No. of poles: 10, 180°, Solder pin length (l): 3.2 mm, tinned, Orange, Box	4008190204228	36 pc(s).	IEC: 400 V / 23 A UL: 300 V / 15 A	Box

OMNIMATE Signal - series BL/SL 5.08 SLDF 5.08 L/F 10 SN OR BX

Weidmüller Interface GmbH & Co. KG
 Klingenbergstraße 16
 D-32758 Detmold
 Germany
 Fon: +49 5231 14-0
 Fax: +49 5231 14-292083
 www.weidmueller.com

Mating connector (fully pluggable)

BLIDC 5.08



Female plugs with IDC wire connection system. The female plugs provide space for labelling and can be coded.

- 0.35 - 0.75 mm² (IEC) / 22 - 20 AWG (UL)
- 400 V (IEC) / 300 V (UL)
- 11 A (IEC) / 5 A (UL)

General ordering data

Available until	Type	Order No.	Version	GTIN (EAN)	Qty.	Product data
2009-12-31	BLIDC 5.08 L/F 10 SN OR BX	1725020000	PCB plug-in connector, female plug, 5.08 mm, No. of poles: 10, 180°, IDC terminal, Clamping range, rated connection, max.: 0.75 mm ² , Box	4008190377366	50 pc(s).	IEC: 400 V / 11 A / 0.5 mm ² UL: 300 V / 5 A / 22 AWG

BLZP 5.08/180 SN



Female plugs with clamping-yoke screw for wire connection with straight (180°) outlet direction. The female plugs provide space for labelling and can be coded. Can be fastened with flange or release latch. They also feature the integrated plus/minus screw, protection from under insertion of wire, and are delivered with open clamping yoke.

- 0.2 - 2.5 mm² (IEC) / 26-12 AWG (UL)
- 400 V (IEC) / 300 V (UL)
- 19 A (IEC) / 15 A (UL)

General ordering data

Type	Order No.	Version	GTIN (EAN)	Qty.	Product data	Packaging
BLZP 5.08HC/10/180 SN BK BX	1943890000	PCB plug-in connector, female plug, 5.08 mm, No. of poles: 10, 180°, Clamping yoke connection,	4032248618002	45 pc(s).	IEC: 400 V / 19 A / 0.2 - 4 mm ² UL: 300 V / 15 A / AWG 30 - AWG 12	Box

**OMNIMATE Signal - series BL/SL 5.08
SLDF 5.08 L/F 10 SN OR BX**

Weidmüller Interface GmbH & Co. KG
Klingenbergstraße 16
D-32758 Detmold
Germany
Fon: +49 5231 14-0
Fax: +49 5231 14-292083
www.weidmueller.com

Mating connector (fully pluggable)

BLZP	1943660000	PCB plug-in connector, female plug, 5.08 mm, No. of poles: 10, 180°, Clamping yoke connection, Clamping range, rated connection, max.: 4 mm ² , Box	4032248617678 45 pc(s).	IEC: 400 V / 19 A / 0.2 - 4 mm ² UL: 300 V / 15 A / AWG 30 - AWG 12	Box
5.08HC/10/180 SN OR BX					

BLZF 5.08/270



Female plugs with tension-clamp wire connection system. The female plugs provide space for labelling and can be coded.

- 0.2 - 2.5 mm² (IEC) / 26 - 12 AWG (UL)
- 400 V (IEC) / 300 V (UL)
- 16.5 A (IEC) / 10 A (UL)

General ordering data

Available until	Type	Order No.	Version	GTIN (EAN)	Qty.	Product data
2014-06-23T00:00:00	BLZF 5.08/270 SN BK BX	1672250000	PCB plug-in connector, female plug, 5.08 mm, No. of poles: 10, 270°, Tension clamp connection, Clamping range, rated connection, max.: 3.31 mm ² , Box	4008190433963 36 pc(s).		IEC: 400 V / 16.5 A / 0.2 - 2.5 mm ² UL: 300 V / 10 A / 26 - 12 AWG
This article will no longer be available in the future.	2015-12-31T00:00:00+01:00	BLZF 5.08/10/270 SN OR BX	1672020000	PCB plug-in connector, female plug, 5.08 mm, No. of poles: 10, 270°, Tension clamp connection, Clamping range, rated connection,	4008190433734	36 pc(s).

**OMNIMATE Signal - series BL/SL 5.08
SLDF 5.08 L/F 10 SN OR BX**

Weidmüller Interface GmbH & Co. KG
Klingenbergstraße 16
D-32758 Detmold
Germany
Fon: +49 5231 14-0
Fax: +49 5231 14-292083
www.weidmueller.com

Mating connector (fully pluggable)

max.: 3.31 mm²,
Box

BLZF 5.08/180



Female plugs with tension-clamp wire connection system, straight 180° outlet direction. The female plugs provide space for labelling and can be coded.

- 0.2 - 2.5 mm² (IEC) / 26 - 12 AWG (UL)
- 400 V (IEC) / 300 V (UL)
- 17 A (IEC) / 15 A (UL)

General ordering data

Delivery status	Available until	Type	Order No.	Version	GTIN (EAN)	Qty.
This article will no longer be available in the future.	2015-12-31T00:00:00+01:00	BLZF 5.08/10/180 SN BK BX	1707770000	PCB plug-in connector, female plug, 5.08 mm, No. of poles: 10, 180°, Tension clamp connection, Clamping range, rated connection, max.: 3.31 mm ² , Box	4008190316778	36 pc(s).
This article will no longer be available in the future.	2015-12-31T00:00:00+01:00	BLZF 5.08/10/180 SN OR BX	1707540000	PCB plug-in connector, female plug, 5.08 mm, No. of poles: 10, 180°, Tension clamp connection, Clamping range, rated connection, max.: 3.31 mm ² , Box	4008190950200	36 pc(s).

**OMNIMATE Signal - series BL/SL 5.08
SLDF 5.08 L/F 10 SN OR BX**

Weidmüller Interface GmbH & Co. KG
 Klingenbergstraße 16
 D-32758 Detmold
 Germany
 Fon: +49 5231 14-0
 Fax: +49 5231 14-292083
 www.weidmueller.com

Mating connector (fully pluggable)
BLZF 5.08/90

Female plugs with tension-clamp wire connection system. The female plugs provide space for labelling and can be coded.

- 0.2 - 2.5 mm² (IEC) / 26 - 12 AWG (UL)
- 400 V (IEC) / 300 V (UL)
- 16.5 A (IEC) / 10 A (UL)

General ordering data

Delivery status	Available until	Type	Order No.	Version	GTIN (EAN)	Qty.
This article will no longer be available in the future.	2015-12-31T00:00:00+01:00	BLZF 5.08/10/90 SN OR BX	1670870000	PCB plug-in connector, female plug, 5.08 mm, No. of poles: 10, 90°, Tension clamp connection, Clamping range, rated connection, max.: 3.31 mm ² , Box	4008190432461	36 pc(s).
This article will no longer be available in the future.	2015-12-31T00:00:00+01:00	BLZF 5.08/10/90 SN BK BX	1671100000	PCB plug-in connector, female plug, 5.08 mm, No. of poles: 10, 90°, Tension clamp connection, Clamping range, rated connection, max.: 3.31 mm ² , Box	4008190432775	36 pc(s).

BLZ 5.08/225

Female plugs with clamping-yoke screw for wire connection with 225° outlet direction. The female plugs provide space for labelling and can be coded.

- 0.2 - 2.5 mm² (IEC) / 26 - 12 AWG (UL)
- 400 V (IEC) / 300 V (UL)
- 16.5 A (IEC) / 10 A (UL)

General ordering data

Available until	Type	Order No.	Version	GTIN (EAN)	Qty.	Product data
2014-06-25T00:00:00+02:00	BLZ 5.08/225 SN BK BX	1741950000	PCB plug-in connector, female plug, 5.08 mm,	400819027288336	36 pc(s).	IEC: 400 V /

**OMNIMATE Signal - series BL/SL 5.08
SLDF 5.08 L/F 10 SN OR BX**

Weidmüller Interface GmbH & Co. KG
Klingenbergstraße 16
D-32758 Detmold
Germany
Fon: +49 5231 14-0
Fax: +49 5231 14-292083
www.weidmueller.com

Mating connector (fully pluggable)

No. of poles: 10,	16.5
225°, Clamping	A /
yoke connection,	0.2
Clamping range,	-
rated connection,	2.5
max.: 3.31 mm ² ,	mm ²
Box	UL:
	300
	V /
	10
	A /
	AWG
	26
	-
	AWG
	12

This article will no longer be available in the future.	2015-12-31T00:00:00+01:00	BLZ 5.08/10/225 SN OR BX	1741720000	PCB plug-in connector, female plug, 5.08 mm, No. of poles: 10, 225°, Clamping yoke connection, Clamping range, rated connection, max.: 3.31 mm ² , Box	4008190222246	36 pc(s).
---	---------------------------	--------------------------	----------------------------	---	---------------	-----------

BLZP 5.08/270 SN

Female plugs with clamping-yoke screw connection for wire connection and a right-angle (90° or 270°) outlet direction. The female plugs provide space for labelling and can be coded. Can be fastened with flange or release latch. They feature an integrated plus/minus screw, protection against false insertion under clamping yoke. They are delivered with an opened clamping yoke.

- 0.2 – 2.5 mm² (IEC) / 26-12 AWG (UL)
- 400 V (IEC) / 300 V (UL)
- 15 A (IEC) / 10 A (UL)

General ordering data

Type	Order No.	Version	GTIN (EAN)	Qty.	Product data	Packaging
BLZP 5.08HC/10/270 SN BK BX	1949100000	PCB plug-in connector, female plug, 5.08 mm, No. of poles: 10, 270°, Clamping yoke connection, Clamping range, rated connection, max.: 4 mm ² , Box	4032248626557	36 pc(s).	IEC: 400 V / 15.5 A / 0.2 - 4 mm ² UL: 300 V / 15 A / AWG 30 - AWG 12	Box
BLZP 5.08HC/10/270 SN OR BX	1948870000	PCB plug-in connector, female plug, 5.08 mm, No. of poles: 10, 270°, Clamping yoke connection, Clamping range, rated	4032248626328	36 pc(s).	IEC: 400 V / 15.5 A / 0.2 - 4 mm ² UL: 300 V / 15 A / AWG 30 - AWG 12	Box

OMNIMATE Signal - series BL/SL 5.08 SLDF 5.08 L/F 10 SN OR BX

Weidmüller Interface GmbH & Co. KG
 Klingenbergstraße 16
 D-32758 Detmold
 Germany
 Fon: +49 5231 14-0
 Fax: +49 5231 14-292083
 www.weidmueller.com

Mating connector (fully pluggable)

connection, max.: 4 mm²,
 Box

BLDT 5.08



Female plugs with two clamping-yoke screw connections per pole for wire connections with 90° and 270° outlet directions. The female plugs provide space for labelling and can be coded.

- 0.2 - 2.5 mm² (IEC) / 26 - 12 AWG (UL)
- 400 V (IEC) / 300 V (UL)
- 14 A (IEC) / 10 A (UL)

General ordering data

Type	Order No.	Version	GTIN (EAN)	Qty.	Product data	Packaging
BLDT 5.08/10/- SN OR BX	1644810000	PCB plug-in connector, female plug, 5.08 mm, No. of poles: 10, 180°, TOP connection, Clamping range, rated connection, max.: 3.31 mm ² , Box	4008190284022	30 pc(s).	IEC: 400 V / 14 A / 0.2 - 2.5 mm ² UL: 300 V / 10 A / AWG 26 - AWG 12	Box
2014-05-20	1644810000	BLDT 5.08/10/- SN BK BX	1660790000	4008190417246	50 pc(s).	IEC: 400 V / 14 A / 0.2 - 2.5 mm ² UL: 300 V / 10 A / AWG 26 - AWG 12

**OMNIMATE Signal - series BL/SL 5.08
SLDF 5.08 L/F 10 SN OR BX**

Weidmüller Interface GmbH & Co. KG
Klingenbergstraße 16
D-32758 Detmold
Germany
Fon: +49 5231 14-0
Fax: +49 5231 14-292083
www.weidmueller.com

Mating connector (fully pluggable)
BLF 5.08/90 SN

Just as reliable as the tried-and-tested original, with innovation in detail: the BLF 5.08, PUSH-IN version of the BLZ 5.08 female header, features a new connection system and a more compact design. Weidmüller innovative PUSH-IN spring connection features a trend-setting, tool-free wire connection system that is simple to operate. In terms of versatility, the BLF 5.08 offers just as much as the older versions:

- The choice of three wire outlet directions offers you proven design flexibility for your applications.
- Four flange variations, including the patented release latch, so you can design the interlock based on the requirements of the user.
- Use the BLF 5.08 and SL 5.08HC plug combination in order to reach the max. rated specifications.

General ordering data

Type	Order No.	Version	GTIN (EAN)	Qty.	Product data	Packaging
BLF 5.08HC/10/90 SN OR BX	1001610000	PCB plug-in connector, female plug, 5.08 mm, No. of poles: 10, 90°, PUSH IN spring connection, Clamping range, rated connection, max.: 3.31 mm ² , Box	4032248693412	36 pc(s).	IEC: 400 V / 24 A / 0.2 - 2.5 mm ² UL: 300 V / 18.5 A / AWG 26 - AWG 12	Box
BLF 5.08HC/10/90 SN BK BX	1000110001	PCB plug-in connector, female plug, 5.08 mm, No. of poles: 10, 90°, PUSH IN spring connection, Clamping range, rated connection, max.: 3.31 mm ² , Box	4032248690046	36 pc(s).	IEC: 400 V / 24 A / 0.2 - 2.5 mm ² UL: 300 V / 18.5 A / AWG 26 - AWG 12	Box

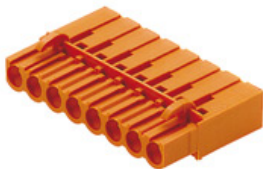
BLC 5.08R

Female plugs with crimp wire connection system. The female plugs provide space for labelling and can be coded.

- 0.25 - 2.5 mm² (IEC) / 26 - 14 AWG (UL)
- 400 V (IEC) / 300 V (UL)
- 21 A (IEC) / 10 A (UL)

General ordering data

Type	Order No.	Version	GTIN (EAN)	Qty.	Product data	Packaging
BLC 5.08/10/180R OR BX	1610570000	PCB plug-in connector, female plug, 5.08 mm, No. of poles: 10, 180°, Crimp connection, Clamping	4008190128180	50 pc(s).	IEC: 400 V / 21 A UL: 300 V / 10 A / AWG 26 - AWG 14	Box

Data sheet

**OMNIMATE Signal - series BL/SL 5.08
SLDF 5.08 L/F 10 SN OR BX**

Weidmüller Interface GmbH & Co. KG
Klingenbergstraße 16
D-32758 Detmold
Germany
Fon: +49 5231 14-0
Fax: +49 5231 14-292083
www.weidmueller.com

Mating connector (fully pluggable)

BLC 5.08/10/180R BK BX	1712040000	range, rated connection, max.: 2.5 mm ² , Box PCB plug-in connector, female plug, 5.08 mm, No. of poles: 10, 180°, Crimp connection, Clamping range, rated connection, max.: 2.5 mm ² , Box	4008190935054 50 pc(s).	IEC: 400 V / 21 A UL: 300 V / 10 A / AWG 26 - AWG 14	Box
------------------------------	----------------------------	--	-------------------------	---	-----

BLZ 5.08/270



Female plugs with clamping-yoke screw connection. The female plugs provide space for labelling and can be coded.

- 0.2 - 2.5 mm² (IEC) / 26 - 12 AWG (UL)
- 400 V (IEC) / 300 V (UL)
- 15 A (IEC) / 10 A (UL)

General ordering data

Delivery status Available until	Type	Order No.	Version	GTIN (EAN)	Qty.
This article will no longer be available in the future. 2015-12-31T00:00:00+01:00	BLZ 5.08/10/270 SN BK BX	1558110000	PCB plug-in connector, female plug, 5.08 mm, No. of poles: 10, 270°, Clamping yoke connection, Clamping range, rated connection, max.: 3.31 mm ² , Box	4008190269500	36 pc(s).
This article will no longer be available in the future. 2015-12-31T00:00:00+01:00	BLZ 5.08/10/270 SN OR BX	1558160000	PCB plug-in connector, female plug, 5.08 mm, No. of poles: 10, 270°, Clamping yoke connection, Clamping range, rated connection, max.: 3.31 mm ² , Box	4008190184247	36 pc(s).

OMNIMATE Signal - series BL/SL 5.08 SLDF 5.08 L/F 10 SN OR BX

Weidmüller Interface GmbH & Co. KG
 Klingenbergstraße 16
 D-32758 Detmold
 Germany
 Fon: +49 5231 14-0
 Fax: +49 5231 14-292083
 www.weidmueller.com

Mating connector (fully pluggable)

BLZ 5.08/90



Female plugs with clamping-yoke screw connection. The female plugs provide space for labelling and can be coded.

- 0.2 - 2.5 mm² (IEC) / 26 - 12 AWG (UL)
- 400 V (IEC) / 300 V (UL)
- 15 A (IEC) / 10 A (UL)

General ordering data

Delivery status	Available until	Type	Order No.	Version	GTIN (EAN)	Qty.
This article will no longer be available in the future.	2015-12-31T00:00:00+01:00	BLZ 5.08/10/90 SN BK BX	1553510000	PCB plug-in connector, female plug, 5.08 mm, No. of poles: 10, 90°, Clamping yoke connection, Clamping range, rated connection, max.: 3.31 mm ² , Box	4008190267797	36 pc(s)
This article will no longer be available in the future.	2015-12-31T00:00:00+01:00	BLZ 5.08/10/90 SN OR BX	1553560000	PCB plug-in connector, female plug, 5.08 mm, No. of poles: 10, 90°, Clamping yoke connection, Clamping range, rated connection, max.: 3.31 mm ² , Box	4008190016852	36 pc(s)

BLZ 5.08/180



Female plugs with clamping-yoke screw for wire connection with straight (180°) outlet direction. The female plugs provide space for labelling and can be coded.

- 0.2 - 2.5 mm² (IEC) / 26 - 12 AWG (UL)
- 400 V (IEC) / 300 V (UL)
- 19 A (IEC) / 15 A (UL)

General ordering data

Delivery status	Available until	Type	Order No.	Version	GTIN (EAN)	Qty.
This article will no longer be available in the future.	2015-12-31T00:00:00+01:00	BLZ 5.08/10/180 SN OR BX	1527260000	PCB plug-in connector, female plug, 5.08 mm, No. of poles: 10,	4008190186265	50 pc(s)

**OMNIMATE Signal - series BL/SL 5.08
SLDF 5.08 L/F 10 SN OR BX**

Weidmüller Interface GmbH & Co. KG
Klingenbergstraße 16
D-32758 Detmold
Germany
Fon: +49 5231 14-0
Fax: +49 5231 14-292083
www.weidmueller.com

Mating connector (fully pluggable)

180°, Clamping
yoke connection,
Clamping range,
rated connection,
max.: 3.31 mm²,
Box

BLZ 5.08/10/180 SN BK BX	1527210000	PCB plug-in connector, female plug, 5.08 mm, No. of poles: 10, 180°, Clamping yoke connection, Clamping range, rated connection, max.: 3.31 mm ² , Box	4008190015602 50 pc(s).	IEC: 400 V / 19 A / 0.2 - 2.5 mm ² UL: 300 V / 15 A / AWG 26 - AWG 12	Box
--------------------------------	----------------------------	---	-------------------------	---	-----

BL 5.08



Female plugs with leaf-spring wire connection system.
The female plugs provide space for labelling.

- 0.2 - 1.5 mm² (IEC) / 26 - 14 AWG (UL)
- 400 V (IEC) / 300 V (UL)
- 11 A (IEC) / 10 A (UL)

General ordering data

Delivery status	Available until	Type	Order No.	Version	GTIN (EAN)	Qty.
This article will no longer be available in the future.	2015-12-31T00:00:00+01:00	BL 5.08/10/180 SN BK BX	1716550000	PCB plug-in connector, female plug, 5.08 mm, No. of poles: 10, 180°, Pressure clamp connection, Clamping range, rated connection, max.: 2.08 mm ² , Box	4008190376628	50 pc(s).
This article will no longer be available in the future.	2015-12-31T00:00:00+01:00	BL 5.08/10/180 SN OR BX	1716400000	PCB plug-in connector, female plug, 5.08 mm, No. of poles: 10, 180°, Pressure clamp connection, Clamping range, rated connection, max.: 2.08 mm ² , Box	4008190376444	50 pc(s).
This article will no longer be available in the future.	2015-12-31T00:00:00+01:00	BL 5.08/10/180 SN DKGN BX	1723910000	PCB plug-in connector, female plug, 5.08 mm, No. of poles: 10, 180°, Pressure clamp connection,	4008190376277	50 pc(s).

Data sheet

**OMNIMATE Signal - series BL/SL 5.08
SLDF 5.08 L/F 10 SN OR BX**

Weidmüller Interface GmbH & Co. KG
Klingenbergstraße 16
D-32758 Detmold
Germany
Fon: +49 5231 14-0
Fax: +49 5231 14-292083
www.weidmueller.com

Mating connector (fully pluggable)

Clamping range,
rated connection,
max.: 2.08 mm²,
Box

Addresses worldwide

Let's connect.

- AE United Arab Emirates**
Weidmüller Middle East FZE
Warehouse Q3-79
SAIF-Zone
P.O. BOX 8591
Sharjah
Tel. +971 65572723
Fax +971 65572724
wme.info@weidmueller.com
- AO Angola**
Please contact
Phambili Interface
South Africa
- AR Argentina**
CPI SA
Bauness 2660
C1431DOF Buenos Aires
Tel. +54 11 4523 8008
Fax +54 11 4522 0546
info@cpi.com.ar
www.cpi.com.ar
- AT Austria**
Weidmüller GmbH
IZ NOE Süd Straße 2b, Obj
M 59
2355 Wiener Neudorf
Tel. +43 2236 67080
Fax +43 2236 6708-899
office.at@weidmueller.com
www.weidmueller.com
- AU Australia**
Weidmüller Pty. Ltd.
PO BOX 6944
Huntingwood 2148
Huntingwood Drive 43
Huntingwood NSW 2148
Tel. +61 2 9671 9999
Fax +61 2 9671 9911
info@weidmuller.com.au
www.weidmuller.com.au
- AZ Azerbaijan**
Representative Office
Rashad Mahmudov
Demirchi Tower, 4th floor
37, Khojali ave.
AZ 1025 Baku
Tel. +994 12 488 80 36
Fax +994 12 488 80 37
rashad.mahmudov@weidmueller.com
- BA Bosnia and Herzegovina**
Please contact
our Representative Office
Weidmüller Interface GmbH
& Co. KG
Serbia
or
BIG electric d.o.o
Mladena Stojanovića 117A
78000 Banja Luka
Tel. +387 51926277
Fax +387 51926277
bigelectric@blic.net
www.bigelectric.ba
- BE Belgium**
Weidmüller Benelux B. V.
Mechelsesteenweg 519 bus
6 en 7
1930 Nossegem
Tel. +32 2 752 40 70
Fax +32 2 751 36 06
info@weidmueller.be
www.weidmueller.be
- BG Bulgaria**
Weid-Bul EOOD
Bul. „Kliment Ohridski“ 13
1756 Sofia
Tel. +359 2 963 2560
Fax +359 2 963 1098
sofia@weidbul.com
www.weidbul.com
- BH Bahrain**
Khayber Trading Company
P.O. Box 1976
Manama
Tel. +973 720747
Fax +973 720331
khayber@batelco.com.bh
- BR Brazil**
Weidmüller Conexel do Brasil
Conexes Elétricas Ltda.
Av. Presidente Juscelino, 642
- Piraporinha
Diadema, São Paulo
09950-370
Tel. +55 (11) 4366-9600
Fax +55 (11) 4362-1677
vendas@weidmueller.com.br
www.weidmueller.com.br
- BW Botswana**
Please contact
Phambili Interface
South Africa
- BY Belarus**
TECHNIKON Ltd.
Nezavisimosti pr. 177-9
220125 Minsk
Tel. +375 17 393-11-77
Fax +375 17 3930080
wm@technikon.by
- CA Canada**
W Interconnections Canada
Inc.
10 Spy Court
Markham Ontario L3R 5H6
Tel. +1 (905) 475-1507
Ext. 9836
Fax +1 (905) 475-2798
support@weidmuller.ca
www.weidmuller.ca
- CG Congo**
Please contact
Phambili Interface
South Africa
- CH Switzerland**
Weidmüller Schweiz AG
Rundbuckstraße 2
8212 Neuhausen am
Rheinfall SH
Tel. +41 52 674 07 07
Fax +41 52 674 07 08
info@weidmueller.ch
www.weidmueller.ch
- CL Chile**
ATS-INTECH
Maria Luisa Santander 0475
Santiago
Providencia 7500859
Tel. +56 2 341 1271
Fax +56 2 341 1275
felipe@atsintech.com
www.atsintech.com
CPI CHILE LTDA
Av. Presidente Frei Montalva
6001, 47 complejo el cortijo
Santiago - Conchalí
Tel. +562 963 8440
Fax +562 963 8440
cpi@cpichile.cl
www.cpicichile.cl
- CN China**
Weidmüller Interface
(Shanghai) Co. Ltd.
100 Yutong Road
25 F, BM Intercontinental
Business Center
200070 Shanghai
Tel. +86 21-22195008
Fax +86 21-22195009
customer.hotline@weidmueller.com.cn
www.cnweidmuller.com
- CO Colombia**
Automatización Avanzada
S. A.
Carrera 97 No., 24 c - 23
Bodega 4
110911 Bogotá-D.C.
Tel. +57 (1) 547-8510
Fax +57 (1) 422-3044
comercial@automatizacionavanzada.com
www.automatizacionavanzada.com
- CR Costa Rica**
ELVATRON S. A.
la Uruca 400 Norte Banco
Costa Rica
San Jose Costa Rica
Tel. +506 2961-060
Fax +506 5200-609
dirk.haase@elvatron.com
www.elvatron.com
- CZ Czech Republic**
Weidmüller s.r.o.
Lomnického 5/1705
140 00 Praha 4
Tel. +420 244 001 400
Fax +420 244 001 499
office@weidmueller.cz
www.weidmueller.cz
- DE Germany**
Weidmüller GmbH & Co. KG
Olmstraße 9
32758 Detmold
Postfach 30 54
32720 Detmold
Tel. +49 5231 1428-0
Fax +49 5231 1428-116
weidmueller@weidmueller.de
www.weidmueller.de
- DK Denmark**
Weidmüller Danmark
Vallensbækvej 18A
2605 Brøndby
Tel. +45 27747800
kundeservice@weidmuller.dk
www.weidmuller.dk
- EC Ecuador**
Elsystec S. A., Electricidad
Sistemas y Tecnología
Vasco de Contreras N35-25 1
y Mañosa
Quito - Pichincha
Tel. +593 22456510
Fax +593 22456755
Elsystec@uio.satnet.net
- EE Estonia**
Please contact
our Representative Office
Weidmüller Interface GmbH
& Co. KG
Latvia
or
Soots Interface OÜ
Pärnu mnt 142
11317 Tallinn
Tel. +372 609 6933
Fax +372 609 6933
info@sootsinterface.ee
www.sootsinterface.ee
- EG Egypt**
Standard Electric (OMEGA)
87, Mohamed Farid Street
Heliopolis
Cairo
Tel. +202 26229000
Fax +202 26221555
stdelec@rite.com
- ES Spain**
Weidmüller, S. A.
Narcis Monturiol 11-13, Pol.
Ind. Sudoeste
8960 Sant Just
Desvern - Barcelona
Tel. +34 934 803 386
Fax +34 933 718 055
weidmuller@weidmuller.es
www.weidmuller.es
- FI Finland**
Weidmüller Suomi,
Weidmüller Aktiebolagetin
sivillike
Koy Plaza Vivace
Ayritie 8C
FI 1510 Vantaa
Tel. +358 20 7351300
Fax +358 800 114 667
asiakaspalvelu@weidmuller.fi
www.weidmuller.fi
- FR France**
Weidmüller E. U. R. L.
12, Chaussée Jules César
BP 263 Osny
95523 Cergy-Pontoise Cedex
Tel. +33 1 34 24 55 00
Fax +33 1 34 24 55 01
mail@weidmuller.fr
- GB Great Britain**
Weidmüller Ltd.
Klippon House
Centurion Court Office Park,
Meridian East, Meridian
Business Park
Leicester
LE19 1TP
Tel. +44 116 282 3470
Fax +44 116 289 3582
marketing@weidmuller.co.uk
www.weidmuller.co.uk
- GE Georgia**
Please contact
our Representative Office
Rashad Mahmudov
Azerbaijan.
- GR Greece**
G.A. Solutions
Ippokratous 11 Metamorfois
144 52 Athen
Tel. +30 210 2823233
Fax +30 210 2823233
info@weidmuller.gr
www.weidmuller.gr
- GT Guatemala**
Prestelectro, Prestegard
Electro. S.A.
Avenida Petapa 44-22,
Zona 12
Guatemala City
Tel. +502 2442-3346
Fax +502 2476-8945
ventas@prestelectro.com
- HK Hong Kong**
Weidmüller (Hong Kong)
Limited Co. Ltd.
Unit 1617, Metropolis Tower
No. 10 Metropolis Drive,
Hunghom, Kowloon
Tel. +852 3154 8088
Fax +852 31548099
Info-hk@weidmueller.com.hk
- HR Croatia**
ElektroPARTNER d.o.o.
Slavonska avenija 24/6
HR-10000 Zagreb
Tel. +385 (1) 6184 793
Fax +385 (1) 6184 795
elektropartner@zg-t.com.hr
www.elektropartner.hr
- HU Hungary**
Weidmüller Kereskedelmi Kft.
Budapest
Gubacsi út 6.
1097
Tel. +36 1 382 7700
Fax +36 1 382 7701
info@weidmueller.hu
www.weidmueller.hu
- ID Indonesia**
PT. Nego Electrindo
Ruko Mega Grosir Cempaka
Mas Blok I No. 20 - 22
Jakarta 10640
Tel. +62 21 42882255
Fax +62 21 42882266
sales@negoelectrindo.co.id
- IE Ireland**
Please contact
Weidmüller Ltd.
Great Britain
- IL Israel**
A. U. Shay Ltd.
23/25, Embar Street
49222 Petach-Tikva
P.O. Box 1 00 49
49222 Petach-Tikva
Tel. +972 3-923-3601
Fax +972 3-923-4601
shay@uriel-shay.com
www.uriel-shay.com
ATEKA Ltd.
4, Ha Tavor lane Industrial
area Segula
49691 Petach-Tikva
P.O. Box 4710
Petach-Tikva
Tel. +972 73-200-1311
Fax +972 3-924 4245
marketing@ateka.co.il
www.ateka.co.il
- IN India**
Representative Office
Weidmüller Electronics India
Pvt. Ltd.
12th Lane North Avenue, Opp
Joggers Park,
Kalyani Nagar, Pune
411 006
Tel. +91 20-41290090
Nitish.Rajan@weidmueller.de
www.weidmueller.com
- IS Iceland**
Samey Automation Center
Lyngas 13
210 Garoabaer
Tel. +354 5 10 5200
Fax +354 5 10 5201
Samey@samey.is
www.samey.is
- IT Italy**
Weidmüller S. r.l.
Via Albert Einstein 4
20092 Cinisello
Balsamo Milano
Tel. +39 02 660681
Fax +39 02 6124945
weidmuller@weidmuller.it
www.weidmuller.it
- JM Jamaica**
Please contact
W Interconnections Inc.
United States
- JO Jordan**
Trans Jordan for Electro
PO Box 33 06 07
Amman
Tel. +962 6 533 2020
Fax +962 6 533 5800
transjordan@batelco.jo
- JP Japan**
Nihon Weidmüller Co. Ltd.
Sphere Tower Tennoz 2-2-8
Higashi-Shinagawa,
Shinagawa-ku
Tokyo
140-0002
Tel. +81 3 6711 5300
Fax +81 3 6711 5333
weidmullerjapan@weidmuller.co.jp
www.weidmuller.co.jp
- KE Kenya**
Please contact
Phambili Interface
South Africa
- KR Korea**
Weidmüller Korea Co. Ltd.
9th floor, Wonbang B/D
Samsseong 2-Dong, Gangnam-Gu
Seoul 143-42
Tel. +82 2-516-0003
Fax +82 2-516-0090
info@weidmuller.co.kr
www.weidmuller.co.kr
- KZ Kazakhstan**
Please contact
OOO Weidmüller
Russia
- LT Lithuania**
Please contact
our Representative Office
Weidmüller Interface GmbH
& Co. KG
Latvia
or
ELEKTROS IRANGA
Tinklu g. 29 a
LT-5319 Panevezys
Tel. +370 (45) 582 828
Fax +370 (45) 582 727
info@eliranga.lt
- LU Luxembourg**
Please contact
Weidmüller Benelux B. V.
Netherlands



You can find all Weidmüller addresses and your local contact on the internet at: www.weidmuller.com/countries

Sales company 

Representation abroad 

without representation abroad 

Let's connect.

- LV Latvia**
SIA Abi4
Daugavgrivas 31b
Riga, LV-1007
Tel. +371 674 70999
Fax +371 674 65637
abi_4@tvnet.lv

Representative Office
Weidmüller Interface GmbH & Co. KG
Udens str. 12-118
Riga, LV-1007
Tel. +371 29254766
Fax +371 676 24562
lgonis.rudaks@weidmuller.com
www.weidmuller.com
- MD Moldova**
BERHORD A & D srl
79/1, str. Milescu Spartaru
MD-2075 Chisinau
Moldova
Tel. +373 (22) 815002
Fax +373 (22) 815007
atiuleanu@berhord.com
www.ad.berhord.com
- ME Montenegro**
Please contact our Representative Office
Weidmüller Interface GmbH & Co. KG
Serbia.
- MG Madagascar**
Please contact Phambili Interface
South Africa
- MK Macedonia**
Please contact our Representative Office
Weidmüller Interface GmbH & Co. KG
Serbia

or
ELEKTRO - SMK dool
UL. III Makedonska brigada
b.b.
1000 Skopje
Tel. +389 22460295
Fax +389 22460298
Elektro-smk@telekabel.net.mk
- MT Malta**
E. S. S., Electrical Supplies & Services Ltd.
San Gwakklin Road
Mrieהל

Tel. +356 21255777
Fax +356 21255999
robert.agiuss@ess.com.mt
- MU Mauritius**
Mubelo Electrical Ltd.
Office 26, Gateway building,
St Jean Road
Quatre Bornes
Mauritius
Tel. +230 4670989
Fax +230 4654051
richard.mubelo@orange.mu
- MW Malawi**
Please contact Phambili Interface
South Africa
- MX Mexico**
W Interconnections S. A.
DE C. V.
Bvd. Hermanos Serdán 698,
Col. San Rafael Oriente
72029 Puebla
Tel. +52 (222) 268 6227
Fax +52 (222) 286 6242
clientes@weidmuller.com.mx
- MY Malaysia**
Connect Plus Technology
Sdn Bhd
No. 43, Jalan PJS 11/22,
Bandar Sunway
46150 Petaling Jaya
Selangor Darul Ehsan
Tel. +60 3 5633 7363
Fax +60 3 5633 6562
paul@cpotech.com.my
www.cpotech.com.my
- MZ Mozambique**
Please contact Phambili Interface
South Africa
- NA Namibia**
Please contact Phambili Interface
South Africa
- NG Nigeria**
Please contact Phambili Interface
South Africa
- NL Netherlands**
Weidmüller Benelux B. V.
Franciscusweg 221
1216 SE Hilversum
P.O. Box 1505
1200 BM Hilversum
Tel. +31 35 626 12 61
Fax +31 35 623 20 44
info@weidmuller.nl
www.weidmuller.nl
- NO Norway**
Sivilingeniør J.F. Knudtzen AS
Billingstadstada 97
1396 Billingstad
PO Box 160
1378 Nesbru
Tel. +47 66 98 33 50
Fax +47 66 98 09 55
firmapost@jfkudtzen.no
www.jfkudtzen.no
- NZ New Zealand**
Cuthbert S. Stewart Ltd.
27 Te Puni Street
Petone
PO Box 38496
Wellington Mail Centre 5054
Tel. (04) 568 6156
Fax (04) 568 6056
csl@cuthbertstewart.co.nz

Cuthbert S. Stewart Ltd
4 Fred Thomas Drive
Aon Building, Ground Floor,
South Entry
Takapuna
PO Box 100 338
North Shore City 745
Tel. (09) 489 1751
Fax (09) 489 1752
cslak@cuthbertstewart.co.nz
- OM Oman**
DAN INTERNATIONAL LLC.
Ghala St. 111
BP 2901
Seeb
Tel. +968 5036 77
Fax +968 5037 55
yedu@danintl.com
- PE Peru**
IMPEXINCA S.A.C.
Calle Ortiz de Zevallos No.
105, Urb. San Antonio
18
Lima, Miraflores
Tel. +51 1 447 5608
info@impexinca.pe
www.impexinca.pe

J & W CIA. S. A.
Calle 6 Mz. D Lte. 23, Urb.
Ind. Grimanesa
1
Callao
Tel. +51 1 572 2539
Fax +51 1 572 0152
contacto@jwcia.com
www.jwcia.com
- PH Philippines**
Enclosure Systems Specialists
Inc.
2276 Don Chino Roces
Avenue Extension
Room 103/105 Narra Building
1231 Makati City
Tel. +63 2 813 8580
Fax +63 2 813 8596
sales_encsys@pltdsl.net
www.enclosuresystemsph.com
- PK Pakistan**
Automation Controls (Pak)
Apartment No. 33 C III,
Chenab Block, Allama Iqbal
Town
Lahore
Tel. +92 42 37809948
Fax +92 42 37809950
nadeem@acpak.com.pk
www.acpak.com.pk
- PL Poland**
Weidmüller Sp. z o. o.
ul. Ogrodowa 58
00-876 Warszawa
Tel. +48 22 510 09 40
Fax +48 22 510 09 41
biuro@weidmuller.com.pl
www.weidmuller.pl
- PR Puerto Rico**
Please contact W Interconnections Inc.
United States
- PT Portugal**
Weidmüller Sistemas de Interface S. A.
Estrada Outeiro Polima, R.
Augusto Dias da Silva, Lote B - Esct. 2
São Domingos de Rana
2785-515 Abóboda
Tel. +351 214 459 191
Fax +351 214 455 871
weidmuller@weidmuller.pt
www.weidmuller.pt
- PY Paraguay**
Please contact CPI SA
Argentina
- RO Romania**
Representative Office
Weidmüller Interface GmbH & Co. KG
Ionescu Crum Street, No. 1,
1st Tower, 1st Floor, Office 4
500446 Brasov - Brasov
Business Park
Tel. +40 (268) 446 222
Fax +40 (268) 446 224
claudiu.totea@weidmuller.com
www.weidmuller.com
- RS Serbia**
Representative Office
Weidmüller Interface GmbH & Co. KG
Ustanička 189, III sprat
Iokal 7a
11050 Beograd
Tel. +381 11 2885274
Fax +381 11 2885274
zoran.rabrenovic@weidmuller.com
- RU Russia**
OOO Weidmüller
Warshavskoye highway, 25
A, bld. 6
Moskau
117105
Tel. +7 (495) 771-69-40
Fax +7 (495) 771-69-41
Info@weidmuller.ru
www.weidmuller.ru
- SA Saudi Arabia**
Please contact Weidmüller Middle East FZE
United Arab Emirates
- SE Sweden**
Weidmüller AB
Axel Danielssons väg 271
BOX 31025
SE-200 49 Malmö
Tel. +46 77-143 00 44
Fax +46 40-37 48 60
info@weidmuller.se
www.weidmuller.se
- SG Singapore**
Weidmüller Pte. Ltd.
70 Bendemeer Road
04-03 Luzerne Building
Singapore 339940
Tel. +65 6841 5311
Fax +65 6841 5377
info@weidmuller.com.sg
www.weidmuller.com.sg
- SI Slovenia**
Elektrospoji d. o. o.
Stegne 27
SI- 1000 Ljubljana
Osrednjeslovenska
Tel. +386 1 511 3810
Fax +386 1 511 1604
info@elektrospoji.si
www.elektrospoji.si
- SK Slovakia**
ELEKTRIS s.r.o.
Elektrárnská 1
831 04 Bratislava
Tel. +421 2/4920 0113
Fax +421 2/4920 0119
bratislava@elektris.sk
- SV El Salvador**
Prestegard Electro
11 Avenida Norte No. 240
Edificio Salazar No. 2
San Salvador
Tel. +503 2271 1690
Fax +503 2221 3851
prestegard@navegante.com.sv
- SY Syria**
Please contact Weidmüller Middle East FZE
United Arab Emirates
- SZ Swaziland**
Please contact Phambili Interface
South Africa
- TH Thailand**
Pisanu Engineering Co. Ltd.
Kwang Dingaeng, Khet Dingaeng
800/2 Soi Trakulsuk, Asokedindaeng Road
Dindaeng, Bangkok 10400
Tel. +66 2 248 2896
Fax +66 2 642 9220
ecsales@pisanu.co.th
www.pisanu.co.th

Representative Office
Weidmüller Pte. Ltd.
37/F, Sathorn Square Building
98 North Sathorn Road
Bangkok, Silom Bangrak 10500
Tel. +66 2 105 6300
Fax +662 105 6301
info@weidmuller.com.sg
- TN Tunisia**
Please contact Weidmüller E. U. R. L.
France
- TR Turkey**
Weidmüller Elektronik Ticaret Ltd. Sirketi
Kavacık Mah. Orhan Veli Kanık Caddesi 9/1
34810 Beykoz / Istanbul
Tel. +90 (216) 537 10 70
Fax +90 (216) 537 10 77
info@weidmuller.com.tr
www.weidmuller.com.tr
- TW Taiwan**
Weidmüller (Hong Kong) Limited
No. 3, Lane 89, ChungYang N. Rd.
24148 SanChuang City, Taipei
Tel. +886 921 949 751
roy.lin@weidmuller.com.hk
- TZ Tanzania**
Please contact Phambili Interface
South Africa
- UA Ukraine**
LLC WM UKRAINE
Levanevskogo str. 6
Kiev
3058
Tel. +38 044 490 32 48
Fax +38 044 490 32 49
info@wm-ua.com.ua
wm-ua.com.ua/

Representative Office
Weidmüller Interface GmbH & Co. KG
Z. office 303
7-D, Zdobunivska str.
Kiev, 2081
Mobile +38 050 440 25 24
info.ua@weidmuller.com
- US United States**
W Interconnections Inc.
821 Southlake Boulevard
Richmond Virginia 23236
Tel. +1 (804) 794-2877
Fax +1 (804) 379-2593
info@weidmuller.com
www.weidmuller.com
- UZ Republic of Uzbekistan**
Please contact OOO Weidmüller
Russia
- VN Vietnam**
AUMI Industrial Equipment & Automation Company Limited
E1, La Thanh Hotel
218 Doi Can Street
Lieu Giai Ward, Ba Dinh District
Hanoi City
Tel. +84 4 37628601
Fax +84 4 62661391
aumi@aumi.com.vn
www.aumi.com.vn

Representative Office
Weidmüller Pte. Ltd.
Level 16 Saigon Tower Building
29 Le Duan Street
District 1
Ho Chi Minh
Tel. +848 3520 7717
Fax +848 3520 7604
info@weidmuller.com.sg
- ZA South Africa**
Phambili Interface
PO Box 193
1609 Johannesburg, Edenvale
5 Bundo Road, Sebenza
1610 Johannesburg
Tel. +27 (11) 4521930
Fax +27 (11) 4526455
info@weidmuller.co.za
www.weidmuller.co.za
- ZM Zambia**
Please contact Phambili Interface
South Africa
- ZW Zimbabwe**
Please contact Phambili Interface
South Africa

