

WIMA MKP-X2



Metallized Polypropylene (PP) RFI-Capacitors Class X2 PCM 7.5 mm to 37.5 mm

Special Features

- Reliable self-healing
- High degree of interference suppression due to good attenuation and low ESR
- According to RoHS 2011/65/EU

Typical Applications

Class X2 RFI applications to meet EMC regulations

- Capacitors connected to the mains between phase and neutral or phase conductors
- General requirements, pulse peak voltage ≤ 2.5 kV

Construction

Dielectric:

Polypropylene (PPI) film

Capacitor electrodes:

Vacuum-deposited

Internal construction:

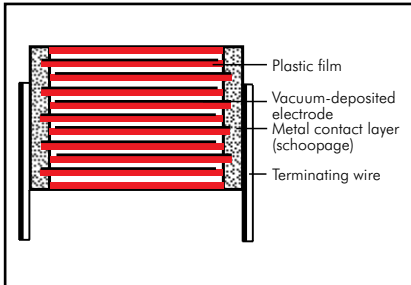

Encapsulation:

Solvent-resistant, flame-retardant plastic case with epoxy resin seal, UL 94 V-0

Terminations:

Tinned wire.

Marking:

Colour: Red. Marking: Black.

Electrical Data

Capacitance range: 1000 pF to 10 μ F

Rated voltage: 305 VAC

Continuous DC voltage* (general guide): ≤ 560 V

Capacitance tolerances: $\pm 20\%$, $\pm 10\%$, ($\pm 5\%$ available subject to special enquiry)

Operating temperature range:

-55° C to $+105^\circ$ C

Climatic test category:

55/105/56 in accordance with IEC

Passive flammability class:

B for capacitors with $V > 1750$ mm³

C for capacitors with $V \leq 1750$ mm³

Test specifications:

In accordance with IEC 60384-14

Dissipation factors at $+20^\circ$ C: $\tan \delta$

at f	$C \leq 0.1 \mu\text{F}$	$0.1 \mu\text{F} < C \leq 1.0 \mu\text{F}$	$C > 1.0 \mu\text{F}$
1 kHz	$\leq 15 \times 10^{-4}$	$\leq 20 \times 10^{-4}$	$\leq 30 \times 10^{-4}$
10 kHz	$\leq 20 \times 10^{-4}$	$\leq 60 \times 10^{-4}$	-
100 kHz	$\leq 100 \times 10^{-4}$	-	-

Insulation resistance at $+20^\circ$ C:

$C \leq 0.33 \mu\text{F}$: $\geq 15 \times 10^3$ M Ω

$C > 0.33 \mu\text{F}$: ≥ 5000 sec (M $\Omega \times \mu\text{F}$)

Measuring voltage: 100 V/1 min.

Maximum pulse rise time:

100 V/ μsec for pulses equal to a voltage

amplitude with $\sqrt{2} \times 305$ VAC = 432 V

according to IEC 60384-14

Test voltage:

$C \leq 1.0 \mu\text{F}$: 2260 VDC, 2 sec.

$C > 1.0 \mu\text{F}$: 1800 VDC, 2 sec.

Reliability:

Operational life > 300000 hours

Failure rate < 2 fit ($0.5 \times U_r$ and 40° C)

Approvals:

Country	Authority	Specification	Symbol	Approval-No.
Germany	VDE	IEC 60384-14/3 (275 VAC)		40003472
USA/Canada	UL	UL 60384-14 (275 VAC) CAN/CSA-E60384-14 (275 VAC)		E 134915
USA/Canada	UL	UL 1283 (305 VAC) C 22.2 No. 8 (305 VAC)		E 100438

ENEC and UL (60384-14) approvals for 305 VAC under preparation

Mechanical Tests

Pull test on pins: 10 N in direction of pins according to IEC 60068-2-21

Vibration: 6 hours at 10...2000 Hz and 0.75 mm displacement amplitude or 10 g in accordance with IEC 60068-2-6

Low air density: 1kPa = 10 mbar in accordance with IEC 60068-2-13

Bump test: 4000 bumps at 390 m/sec² in accordance with IEC 60068-2-29

* If safety-approved EMI suppression capacitors are operated with a DC voltage being above the specified AC voltage rating the given approvals are no longer valid (IEC 60384-14).

Furthermore the permissible pulse rise time du/dt (F_{max}) will be subject to a reduction according to

$$F_{\text{max}} = F_r \times \sqrt{2} \times U_{\text{AC}} / U_{\text{DC}}$$

if the DC operating voltage U_{DC} is higher than $\sqrt{2} \times U_{\text{AC}}$

Packing

Available taped and reeled up to and including case size 15 x 26 x 31.5 / PCM 27.5 mm.

Detailed taping information and graphs at the end of the catalogue.

For further details and graphs please refer to Technical Information.

Continuation

General Data

Capacitance	305 VAC*				PCM**	Part number
	W	H	L			
1000 pF	4	9	10		7.5	MKX2AW11002C00_____
1200 "	4	9	10		7.5	MKX2AW11202C00_____
1500 "	4	9	10		7.5	MKX2AW11502C00_____
1800 "	4	9	10		7.5	MKX2AW11802C00_____
2200 "	4	9	10		7.5	MKX2AW12202C00_____
2700 "	4	9	10		7.5	MKX2AW12702C00_____
3300 "	4	9	10		7.5	MKX2AW13302C00_____
3900 "	4	9	10		7.5	MKX2AW13902C00_____
4700 "	4	9	10		7.5	MKX2AW14702C00_____
5600 "	4	9	10		7.5	MKX2AW15602C00_____
6800 "	4	9	10		7.5	MKX2AW16802C00_____
8200 "	4	9	10		7.5	MKX2AW18202C00_____
0.01 µF	4	9	10		7.5	MKX2AW21002C00_____
	5	11	13		10	MKX2AW21003F00_____
0.012 "	4	9	10		7.5	MKX2AW21202C00_____
	5	11	13		10	MKX2AW21203F00_____
0.015 "	4	9	10		7.5	MKX2AW21502C00_____
	5	11	13		10	MKX2AW21503F00_____
0.018 "	4	9	10		7.5	MKX2AW21802C00_____
	5	11	13		10	MKX2AW21803F00_____
0.022 "	4	9	10		7.5	MKX2AW22202C00_____
	5	11	13		10	MKX2AW22203F00_____
0.027 "	5	10.5	10.3		7.5	MKX2AW22702E00_____
	5	11	13		10	MKX2AW22703F00_____
0.033 "	5	10.5	10.3		7.5	MKX2AW23302E00_____
	5	11	13		10	MKX2AW23303F00_____
0.039 "	5.7	12.5	10.3		7.5	MKX2AW23902F00_____
	5	11	13		10	MKX2AW23903F00_____
0.047 "	5.7	12.5	10.3		7.5	MKX2AW24702F00_____
	6	12.5	13		10	MKX2AW24703H00_____
0.056 "	5	11	18		15	MKX2AW24704B00_____
	6	12.5	13		10	MKX2AW25603H00_____
0.068 "	5	11	18		15	MKX2AW25604B00_____
	6	12.5	13		10	MKX2AW26803H00_____
0.082 "	5	11	18		15	MKX2AW26804B00_____
	6	12.5	13		10	MKX2AW28203H00_____
	5	11	18		15	MKX2AW28204B00_____

* f = 50/60 Hz

■ New values or box sizes

** PCM = Printed circuit module = pin spacing

Dims. in mm.

d = 0.6 ø if PCM < 15
d = 0.8 ø if PCM ≥ 15

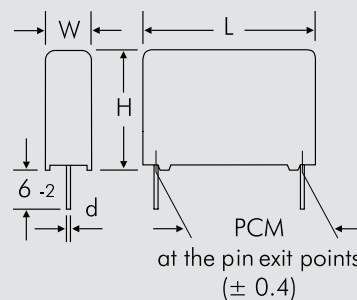

Part number completion:	
Tolerance:	20 % = M
	10 % = K
	5 % = J
Packing:	bulk = S
Pin length:	6-2 = SD
Taped version see page 140.	

Rights reserved to amend design data without prior notification.

Continuation

General Data

Capacitance	305 VAC*				Part number
	W	H	L	PCM**	
0.1 μ F	8	12	13	10	MKX2AW31003I00_____
	5	11	18	15	MKX2AW31004B00_____
	6	12.5	18	15	MKX2AW31004C00_____
0.12 "	6	12.5	18	15	MKX2AW31204C00_____
0.15 "	6	12.5	18	15	MKX2AW31504C00_____
	8	15	18	15	MKX2AW31504F00_____
	6	15	26.5	22.5	MKX2AW31505B00_____
0.18 "	8	15	18	15	MKX2AW31804F00_____
	6	15	26.5	22.5	MKX2AW31805B00_____
	9	14	18	15	MKX2AW32204H00_____
0.22 "	8	15	18	15	MKX2AW32204F00_____
	6	15	26.5	22.5	MKX2AW32205B00_____
	8	15	18	15	MKX2AW32704F00_____
0.27 "	7	16.5	26.5	22.5	MKX2AW32705D00_____
	11	14	18	15	MKX2AW33304M00_____
	9	16	18	15	MKX2AW33304J00_____
0.33 "	7	16.5	26.5	22.5	MKX2AW33305D00_____
	8.5	18.5	26.5	22.5	MKX2AW33905F00_____
	8.5	18.5	26.5	22.5	MKX2AW34705F00_____
0.47 "	10.5	19	26.5	22.5	MKX2AW34705G00_____
	9	19	31.5	27.5	MKX2AW34706A00_____
	10.5	19	26.5	22.5	MKX2AW35605G00_____
0.56 "	9	19	31.5	27.5	MKX2AW35606A00_____
	10.5	19	26.5	22.5	MKX2AW36805G00_____
	11	21	26.5	22.5	MKX2AW36805I00_____
0.68 "	9	19	31.5	27.5	MKX2AW36806A00_____
	11	21	26.5	22.5	MKX2AW38205I00_____
	9	19	31.5	27.5	MKX2AW38206A00_____

* f = 50/60 Hz

New values or box sizes

** PCM = Printed circuit module = pin spacing

Dims. in mm.

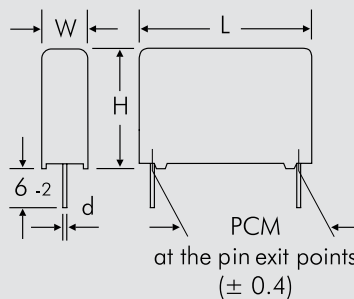

Part number completion:	
Tolerance:	20 % = M
	10 % = K
	5 % = J
Packing:	bulk = S
Pin length:	6-2 = SD
Taped version see page 140.	

d = 0.6 ϕ if PCM = 10
d = 0.8 ϕ if PCM \geq 15

Rights reserved to amend design data without prior notification.

Continuation page 78

Continuation

General Data

Capacitance	305 VAC*				
	W	H	L	PCM**	Part number
1.0 μ F	11	21	26.5	22.5	MKX2AW41005I00_____
	11	21	31.5	27.5	MKX2AW41006B00_____
	13	24	31.5	27.5	MKX2AW41006D00_____
1.2 "	11	21	31.5	27.5	MKX2AW41206B00_____
1.5 "	13	24	31.5	27.5	MKX2AW41506D00_____
	15	26	31.5	27.5	MKX2AW41506F00_____
1.8 "	13	24	41.5	37.5	MKX2AW41507C00_____
	13	24	31.5	27.5	MKX2AW41806D00_____
	13	24	41.5	37.5	MKX2AW41807C00_____
2.2 "	15	26	31.5	27.5	MKX2AW42206F00_____
	17	29	31.5	27.5	MKX2AW42206G00_____
	13	24	41.5	37.5	MKX2AW42207C00_____
2.7 "	15	26	41.5	37.5	MKX2AW42207D00_____
	17	29	31.5	27.5	MKX2AW42706G00_____
	15	26	41.5	37.5	MKX2AW42707D00_____
3.3 "	17	29	41.5	37.5	MKX2AW42707E00_____
	17	34.5	31.5	27.5	MKX2AW43306I00_____
	20	39.5	31.5	27.5	MKX2AW43306J00_____
3.9 "	15	26	41.5	37.5	MKX2AW43307D00_____
	17	29	41.5	37.5	MKX2AW43307E00_____
	17	34.5	31.5	27.5	MKX2AW43906I00_____
4.7 "	17	29	41.5	37.5	MKX2AW43907E00_____
	19	32	41.5	37.5	MKX2AW43907F00_____
	20	39.5	31.5	27.5	MKX2AW44706J00_____
5.6 "	19	32	41.5	37.5	MKX2AW44707F00_____
	20	39.5	41.5	37.5	MKX2AW44707G00_____
	19	32	41.5	37.5	MKX2AW45607F00_____
6.8 "	20	39.5	41.5	37.5	MKX2AW45607G00_____
	20	39.5	41.5	37.5	MKX2AW46807G00_____
8.2 "	24	45.5	41.5	37.5	MKX2AW46807H00_____
	24	45.5	41.5	37.5	MKX2AW48207H00_____
	31	46	41.5	37.5	MKX2AW48207I00_____
10 μ F	24	45.5	41.5	37.5	MKX2AW51007H00_____
	31	46	41.5	37.5	MKX2AW51007I00_____

* f = 50/60 Hz

■ New values or box sizes

** PCM = Printed circuit module = pin spacing

Dims. in mm.

d = 0.8 ϕ if PCM \leq 27.5
d = 1.0 ϕ if PCM = 37.5

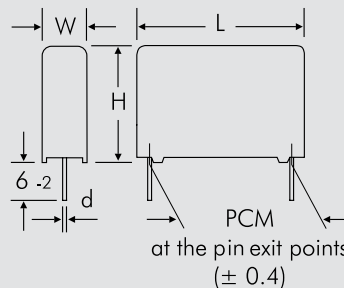

Part number completion:	
Tolerance:	20 % = M
	10 % = K
	5 % = J
Packing:	bulk = S
Pin length:	6-2 = SD
Taped version see page 140.	

Rights reserved to amend design data without prior notification.

Recommendation for Processing and Application of Through-Hole Capacitors

Soldering Process

Internal temperature of the capacitor must be kept as follows:

Polyester: preheating: $T_{max.} \leq 125^{\circ}C$
soldering: $T_{max.} \leq 135^{\circ}C$

Polypropylene: preheating: $T_{max.} \leq 100^{\circ}C$
soldering: $T_{max.} \leq 110^{\circ}C$

Single wave soldering

Soldering bath temperature: $T < 260^{\circ}C$

Dwell time: $t < 5 \text{ sec}$

Double wave soldering

Soldering bath temperature: $T < 260^{\circ}C$

Dwell time: $\Sigma t < 5 \text{ sec}$

Due to different soldering processes and heat requirements the graphs are to be regarded as a recommendation only.

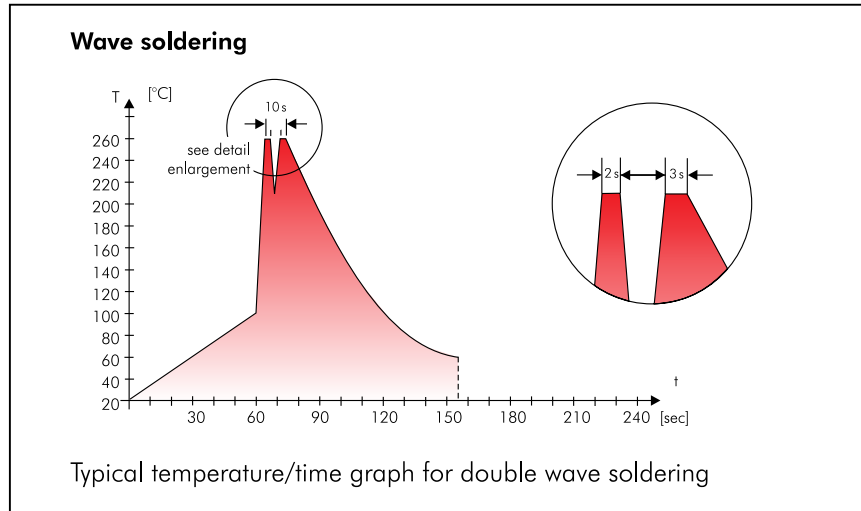

WIMA Quality and Environmental Philosophy

ISO 9001:2008 Certification

ISO 9001:2008 is an international basic standard of quality assurance systems for all branches of industry. The approval according to ISO 9001:2008 of our factories by the VDE inspectorate certifies that organisation, equipment and monitoring of quality assurance in our factories correspond to internationally recognized standards.

WIMA WPCS

The WIMA Process Control System (WPCS) is a quality surveillance and optimization system developed by WIMA. WPCS is a major part of the quality-oriented WIMA production. Points of application of WPCS during production process:

- incoming material inspection
- metallization
- film inspection
- schoopage
- pre-healing
- pin attachment
- cast resin preparation/encapsulation
- 100% final inspection
- Testing as per customer requirements

WIMA Environmental Policy

All WIMA capacitors, irrespective of whether through-hole devices or SMD, are made of environmentally friendly materials. Neither during manufacture nor in the product itself any toxic substances are used, e.g.

- Lead
- PCB
- CFC
- Hydrocarbon chloride
- Chromium 6+
- PBB/PBDE
- Arsenic
- Cadmium
- Mercury
- etc.

We merely use pure, recyclable materials for packing our components, such as:

- carton
- cardboard
- adhesive tape made of paper
- polystyrene

We almost completely refrain from using packing materials such as:

- foamed polystyrene (Styropor®)
- adhesive tapes made of plastic
- metal clips

RoHS Compliance

According to the RoHS Directive 2011/65/EU certain hazardous substances like e.g. lead, cadmium, mercury must not be used any longer in electronic equipment as of July 1st, 2006. For the sake of the environment WIMA has refrained from using such substances since years already.



WIMA Kondensatoren sind bleifrei konform RoHS 2011/65/EU

WIMA capacitors are lead free in accordance with RoHS 2011/65/EU

Tape for lead-free WIMA capacitors

DIN EN ISO 14001:2004

WIMA's environmental management has been established in accordance with the guidelines of DIN EN ISO 14001:2004 to optimize the production processes with regard to energy and resources.

Typical Dimensions for Taping Configuration

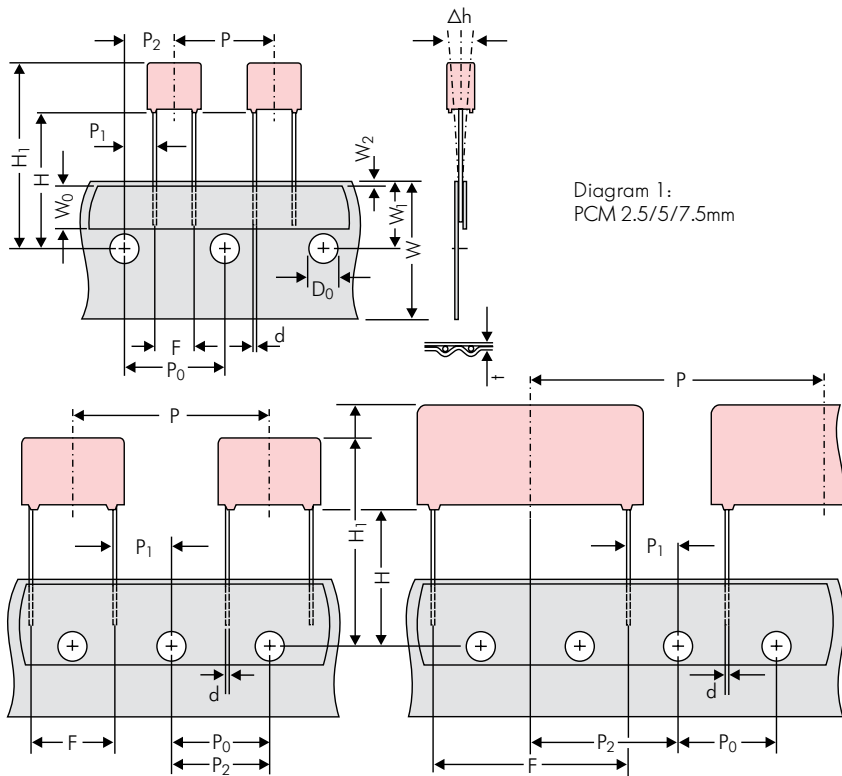

Diagram 2: PCM 10/15 mm

Diagram 3: PCM 22.5 and 27.5*mm

*PCM 27.5 tapping possible with two feed holes between components

Designation	Symbol	Dimensions for Radial Taping									
		PCM 2.5 tapping	PCM 5 tapping	PCM 7.5 tapping	PCM 10 tapping*	PCM 15 tapping*	PCM 22.5 tapping	PCM 27.5 tapping			
Carrier tape width	W	18.0 ±0.5	18.0 ±0.5	18.0 ±0.5	18.0 ±0.5	18.0 ±0.5	18.0 ±0.5	18.0 ±0.5			
Hold-down tape width	W ₀	6.0 for hot-sealing adhesive tape	6.0 for hot-sealing adhesive tape	12.0 for hot-sealing adhesive tape	12.0 for hot-sealing adhesive tape	12.0 for hot-sealing adhesive tape	12.0 for hot-sealing adhesive tape	12.0 for hot-sealing adhesive tape			
Hole position	W ₁	9.0 ±0.5	9.0 ±0.5	9.0 ±0.5	9.0 ±0.5	9.0 ±0.5	9.0 ±0.5	9.0 ±0.5			
Hold-down tape position	W ₂	0.5 to 3.0 max.	0.5 to 3.0 max.	0.5 to 3.0 max.	0.5 to 3.0 max.	0.5 to 3.0 max.	0.5 to 3.0 max.	0.5 to 3.0 max.			
Feed hole diameter	D ₀	4.0 ±0.2	4.0 ±0.2	4.0 ±0.2	4.0 ±0.2	4.0 ±0.2	4.0 ±0.2	4.0 ±0.2			
Pitch of component	P	12.7 ±1.0	12.7 ±1.0	12.7 ±1.0	25.4 ±1.0	25.4 ±1.0	38.1 ±1.5	38.1 ±1.5 or 50.8 ±1.5			
Feed hole pitch	P ₀	12.7 ±0.3 cumulative pitch error max. 1.0 mm/20 pitch	12.7 ±0.3 cumulative pitch error max. 1.0 mm/20 pitch	12.7 ±0.3 cumulative pitch error max. 1.0 mm/20 pitch	12.7 ±0.3 cumulative pitch error max. 1.0 mm/20 pitch	12.7 ±0.3 cumulative pitch error max. 1.0 mm/20 pitch	12.7 ±0.3 cumulative pitch error max. 1.0 mm/20 pitch	12.7 ±0.3 cumulative pitch error max. 1.0 mm/20 pitch			
Feed hole centre to pin	P ₁	5.1 ±0.5	3.85 ±0.7	2.6 ±0.7	7.7 ±0.7	5.2 ±0.7	7.8 ±0.7	5.3 ±0.7			
Hole centre to component centre	P ₂	6.35 ±1.3	6.35 ±1.3	6.35 ±1.3	12.7 ±1.3	12.7 ±1.3	19.05 ±1.3	19.05 ±1.3			
Feed hole centre to bottom edge of the component	H	16.5 ±0.3	16.5 ±0.3	16.5 ±0.5	16.5 ±0.5	16.5 ±0.5	16.5 ±0.5	16.5 ±0.5			
Feed hole centre to top edge of the component	H ₁	H+H _{component} < H ₁ 32.25 max.	H+H _{component} < H ₁ 32.25 max.	H+H _{component} < H ₁ 24.5 to 31.5	H+H _{component} < H ₁ 25.0 to 31.5	H+H _{component} < H ₁ 26.0 to 37.0	H+H _{component} < H ₁ 30.0 to 43.0	H+H _{component} < H ₁ 35.0 to 45.0			
Pin spacing at upper edge of carrier tape	F	2.5 ±0.5	5.0 ^{+0.8} _{-0.2}	7.5 ±0.8	10.0 ±0.8	15 ±0.8	22.5 ±0.8	27.5 ±0.8			
Pin diameter	d	0.4 ±0.05	0.5 ±0.05	0.5 ±0.05 or 0.6 ^{+0.06} _{-0.05}	0.5 ±0.05 or 0.6 ^{+0.06} _{-0.05}	0.8 ^{+0.08} _{-0.05}	0.8 ^{+0.08} _{-0.05}	0.8 ^{+0.08} _{-0.05}			
Component alignment	Δh	± 2.0 max.	± 2.0 max.	± 3.0 max.	± 3.0 max.	± 3.0 max.	± 3.0 max.	± 3.0 max.			
Total tape thickness	t	0.7 ±0.2	0.7 ±0.2	0.7 ±0.2	0.7 ±0.2	0.7 ±0.2	0.7 ±0.2	0.7 ±0.2			
Package (see also page 141)	ROLL/AMMO			AMMO							
	REEL	φ 360 max. φ 30 ±1	B 52 ±2 58 ±2	depending on comp. dimensions		REEL	φ 360 max. φ 30 ±1	B 52 ±2 58 ±2 or 66 ±2	REEL	φ 500 max. φ 25 ±1	B 60 ±2 68 ±2
Unit	see details page 142.										

Dims in mm.

* Diameter of pins see General Data.

* PCM 10 and PCM 15 can be crimped to PCM 7.5.

Position of components according to PCM 7.5 (sketch 1). P₀ = 12.7 or 15.0 is possible

Please clarify customer-specific deviations with the manufacturer.

Types of Tape Packaging of Capacitors for Automatic Radial Insertion

■ ROLL Packaging

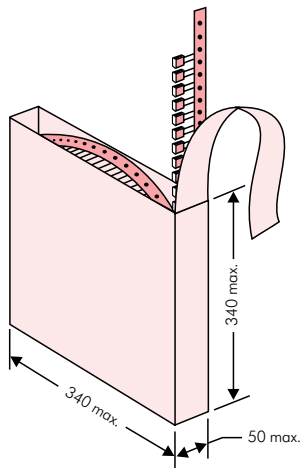

■ AMMO Packaging

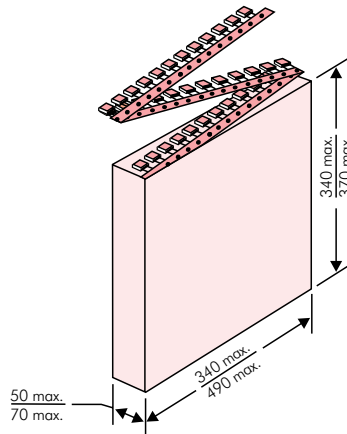

■ REEL Packaging

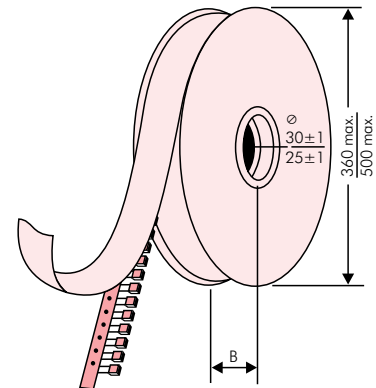

BAR CODE (Labelling)

Labelling of package units in plain text and with alphanumerical Bar Code

Scanner decoding of

- WIMA supplier number
- Customer's P/O number
- Customer's part number
- WIMA confirmation number
- WIMA part number
- Lot number
- Date code
- Quantity

In addition part description of

- article
- capacitance value
- rated voltage
- dimensions
- capacitance tolerance
- packing

as well as gross weight and customer's name are indicated in plain text.

WIMA Best Capacitors Made in Germany		Werk Unna	
Supplier-ID: 123456789	RoHS	Date Code: 08.10.10	
	2011/65/EU		
Purchase Order No. (P/O): Bestellung xyz		Quantity: 5.000	
Customer Part No.: KUNDETEILENUMMER		Customer No.: 0000100002	
		Gross Weight [g]: 1870	
WIMA Confirmation No.: 0001004053000100	WIMA Part No.: MKS2C034701C00K88D		
Handling Unit:	MKS 2	QTY: 5.000	COO: DE
	MKS 2 0.47 µF 63 VDC 3.5x8.5x7.2 RMS		
1000067326	Standard 10% Loss - Standard	Drühte 6-2	Week 03/2011
	Vorlage Debitor Inland		

BARCODE „Code 39“



Packing Quantities for Capacitors with Radial Pins in PCM 2.5 mm to 22.5 mm

PCM	Size				bulk	pcs. per packing unit								
						ROLL		REEL				AMMO		
	W	H	L	Codes		S	H16.5	H18.5	ø 360	ø 500	340 × 340	490 × 370		
					N	O	F	I	H	J	A	C	B	D
2.5 mm	2.5	7	4.6	0B	5000		2200	2500				2800		
	3	7.5	4.6	0C	5000		2000	2300				2300		
	3.8	8.5	4.6	0D	5000		1500	1800				1800		
	4.6	9	4.6	0E	5000		1200	1500				1500		
	5.5	10	4.6	0F	5000		900	1200				1200		
5 mm	2.5	6.5	7.2	1A	5000		2200	2500				2800		
	3	7.5	7.2	1B	5000		2000	2300				2300		
	3.5	8.5	7.2	1C	5000		1600	2000				2000		
	4.5	6	7.2	1D	6000		1300	1500				1500		
	4.5	9.5	7.2	1E	4000		1300	1500				1500		
	5	10	7.2	1F	3500		1100	1400				1400		
	5.5	7	7.2	1G	4000		1000	1200				1200		
	5.5	11.5	7.2	1H	2500		1000	1200				1200		
	6.5	8	7.2	1I	2500		800	1000				1000		
	7.2	8.5	7.2	1J	2500		700	1000				1000		
	7.2	13	7.2	1K	2000		700	950				1000		
	8.5	10	7.2	1L	2000		600	800				800		
	8.5	14	7.2	1M	1500		600	800				800		
11	16	7.2	1N	1000		500	600				400			
7.5 mm	2.5	7	10	2A	5000			2500	4400		2500			
	3	8.5	10	2B	5000			2200	4300		2300		4150	
	4	9	10	2C	4000			1700	3200		1700		3100	
	4.5	9.5	10.3	2D	3500			1500	2900		1400		2800	
	5	10.5	10.3	2E	3000			1300	2500		1300			
	5.7	12.5	10.3	2F	2000			1000	2200		1100			
	7.2	12.5	10.3	2G	1500			900	1800		1000			
10 mm	3	9	13	3A	3000			1100	2200				1900	
	4	8.5	13.5	FA	3000			900	1600				1450	
	4	9	13	3C	3000			900	1600				1450	
	4	9.5	13	3D	3000			900	1600				1400	
	5	10	13.5	FB	2000			700	1300				1200	
	5	11	13	3F	3000			700	1300				1200	
	6	12	13	3G	2400			550	1100				1000	
	6	12.5	13	3H	2400			550	1100				1000	
8	12	13	3I	2000			400	800				740		
15 mm	5	11	18	4B	2400			600	1200				1150	
	5	13	19	FC	1000			600	1200				1200	
	6	12.5	18	4C	2000			500	1000				1000	
	6	14	19	FD	1000			500	1000				1000	
	7	14	18	4D	1600			450	900				850	
	7	15	19	FE	1000			450	900				850	
	8	15	18	4F	1200			400	800				740	
	8	17	19	FF	500			400	800				740	
	9	14	18	4H	1200			350	700				650	
	9	16	18	4J	900			350	700				650	
	10	18	19	FG	500			300	650				590	
11	14	18	4M	1000			300	600				540		
22.5 mm	5	14	26.5	5A	1200				800				770	
	6	15	26.5	5B	1000				700				640	
	7	16.5	26.5	5D	760				600				550	
	8	20	28	FH	500				500				480	
	8.5	18.5	26.5	5F	500				480				450	
	10	22	28	FI	540*				420				380	
	10.5	19	26.5	5G	680*				400				360	
	10.5	20.5	26.5	5H	680*				400				360	
	11	21	26.5	5I	680*				380				350	
	12	24	28	FJ	450*				350				310	

* TPS (Tray-Packing-System). Plate versions may have different packing units.
Samples and pre-production needs on request.

■ Moulded versions.

Rights reserved to amend design data without prior notification.



Packing Quantities for Capacitors with Radial Pins in PCM 27.5 mm to 52.5 mm

PCM	Size				bulk	pcs. per packing unit									
						ROLL		REEL				AMMO			
	W	H	L	Codes		S	N	O	ø 360		ø 500		340 × 340		490 × 370
								H16.5	H18.5	H16.5	H18.5	H16.5	H18.5	H16.5	H18.5
								F	I	H	J	A	C	B	D
27.5 mm	9	19	31.5	6A	640*	–	–	–	–	460/340*	–	–	420		
	11	21	31.5	6B	544*	–	–	–	–	380/280*	–	–	350		
	13	24	31.5	6D	448*	–	–	–	–	300	–	–	290		
	13	25	33	6K	336*	–	–	–	–	–	–	–	–		
	15	26	31.5	6F	384*	–	–	–	–	270	–	–	250		
	15	26	33	6L	288*	–	–	–	–	–	–	–	–		
	17	29	31.5	6G	176*	–	–	–	–	–	–	–	–		
	17	34.5	31.5	6I	176*	–	–	–	–	–	–	–	–		
	20	32	33	6M	216*	–	–	–	–	–	–	–	–		
	20	39.5	31.5	6J	144*	–	–	–	–	–	–	–	–		
37.5 mm	9	19	41.5	7A	480*	–	–	–	–	–	–	–	–		
	11	22	41.5	7B	408*	–	–	–	–	–	–	–	–		
	13	24	41.5	7C	252*	–	–	–	–	–	–	–	–		
	15	26	41.5	7D	144*	–	–	–	–	–	–	–	–		
	17	29	41.5	7E	132*	–	–	–	–	–	–	–	–		
	19	32	41.5	7F	108*	–	–	–	–	–	–	–	–		
	20	39.5	41.5	7G	108*	–	–	–	–	–	–	–	–		
	24	45.5	41.5	7H	84*	–	–	–	–	–	–	–	–		
	27	15	41.5	7M	100*	–	–	–	–	–	–	–	–		
	31	46	41.5	7I	72*	–	–	–	–	–	–	–	–		
	35	50	41.5	7J	35*	–	–	–	–	–	–	–	–		
	40	55	41.5	7K	28*	–	–	–	–	–	–	–	–		
48.5 mm	19	31	56	8D	50*	–	–	–	–	–	–	–	–		
	23	34	56	8E	72*	–	–	–	–	–	–	–	–		
	27	37.5	56	8H	60*	–	–	–	–	–	–	–	–		
	33	48	56	8J	48*	–	–	–	–	–	–	–	–		
	37	54	56	8L	25*	–	–	–	–	–	–	–	–		
52.5 mm	35	50	57	9F	25*	–	–	–	–	–	–	–	–		
	45	55	57	9H	20*	–	–	–	–	–	–	–	–		
	45	65	57	9J	20*	–	–	–	–	–	–	–	–		

* for 2-inch transport pitches.

* TPS (Tray-Packing-System). Plate versions may have different packing units. Samples and pre-production needs on request.

■ Moulded versions.

Rights reserved to amend design data without prior notification.



WIMA Part Number System

A WIMA part number consists of 18 digits and is composed as follows:

- Field 1 - 4: Type description
- Field 5 - 6: Rated voltage
- Field 7 - 10: Capacitance
- Field 11 - 12: Size and PCM
- Field 13 - 14: Version code (e.g. Snubber versions)
- Field 15: Capacitance tolerance
- Field 16: Packing
- Field 17 - 18: Pin length (untaped)

1	2	3	4	5	6	7	8	9	10	11	12	13	14	15	16	17	18
M	K	S	2	C	0	2	1	0	0	1	A	0	0	M	S	S	D
MKS 2				63 VDC		0.01 µF			2.5x6.5x7.2		-		20%	bulk	6-2		
Type description:				Rated voltage:		Capacitance:			Size:		Tolerance:		Packing:				
SMD-PET = SMDT				50 VDC = B0		22 pF = 0022			4.8x3.3x3 Size 1812 = KA		±20% = M		Packing: AMMO H16.5 340x340 = A AMMO H16.5 490x370 = B AMMO H18.5 340x340 = C AMMO H18.5 490x370 = D REEL H16.5 360 = F REEL H16.5 500 = H REEL H18.5 360 = I REEL H18.5 500 = J ROLL H16.5 = N ROLL H18.5 = O BLISTER W12 180 = P BLISTER W12 330 = Q BLISTER W16 330 = R BLISTER W24 330 = T Bulk/TPS Standard = S ...				
SMD-PEN = SMDN				63 VDC = C0		47 pF = 0047			4.8x3.3x4 Size 1812 = KB		±10% = K						
SMD-PPS = SMDI				100 VDC = D0		100 pF = 0100			5.7x5.1x3.5 Size 2220 = QA		±5% = J						
FKP 02 = FKPO				250 VDC = F0		150 pF = 0150			5.7x5.1x4.5 Size 2220 = QB		±2.5% = H						
MKS 02 = MKS0				400 VDC = G0		220 pF = 0220			7.2x6.1x3 Size 2824 = TA		±1% = E						
FKS 2 = FKS2				450 VDC = H0		330 pF = 0330			7.2x6.1x5 Size 2824 = TB		...						
FKP 2 = FKP2				600 VDC = I0		470 pF = 0470			10.2x7.6x5 Size 4030 = VA								
MKS 2 = MKS2				630 VDC = J0		680 pF = 0680			12.7x10.2x6 Size 5040 = XA								
MKP 2 = MKP2				700 VDC = K0		1000 pF = 1100			15.3x13.7x7 Size 6054 = YA								
FKS 3 = FKS3				800 VDC = L0		1500 pF = 1150			2.5x7x4.6 PCM 2.5 = 0B								
FKP 3 = FKP3				850 VDC = M0		2200 pF = 1220			3x7.5x4.6 PCM 2.5 = 0C								
MKS 4 = MKS4				900 VDC = N0		3300 pF = 1330			2.5x6.5x7.2 PCM 5 = 1A								
MKP 4 = MKP4				1000 VDC = O1		4700 pF = 1470			3x7.5x7.2 PCM 5 = 1B								
MKP 10 = MKP1				1100 VDC = P0		6800 pF = 1680			2.5x7x10 PCM 7.5 = 2A								
FKP 4 = FKP4				1200 VDC = Q0		0.01 µF = 2100			3x8.5x10 PCM 7.5 = 2B								
FKP 1 = FKP1				1250 VDC = R0		0.022 µF = 2220			3x9x13 PCM 10 = 3A								
MKP-X2 = MKX2				1500 VDC = S0		0.047 µF = 2470			4x9x13 PCM 10 = 3C								
MKP-X2 R = MKXR				1600 VDC = T0		0.1 µF = 3100			5x11x18 PCM 15 = 4B								
MKP-X1 R = MKX1				2000 VDC = U0		0.22 µF = 3220			6x12.5x18 PCM 15 = 4C								
MKP-Y2 = MKY2				2500 VDC = V0		0.47 µF = 3470			5x14x26.5 PCM 22.5 = 5A								
MP 3-X2 = MPX2				3000 VDC = W0		1 µF = 4100			6x15x26.5 PCM 22.5 = 5B								
MP 3-X1 = MPX1				4000 VDC = X0		2.2 µF = 4220			9x19x31.5 PCM 27.5 = 6A								
MP 3-Y2 = MPY2				6000 VDC = Y0		4.7 µF = 4470			11x21x31.5 PCM 27.5 = 6B								
MP 3R-Y2 = MPRY				250 VAC = 0W		10 µF = 5100			9x19x41.5 PCM 37.5 = 7A								
Snubber MKP = SNMP				275 VAC = 1W		22 µF = 5220			11x22x41.5 PCM 37.5 = 7B								
Snubber FKP = SNFP				300 VAC = 2W		47 µF = 5470			19x31x56 PCM 48.5 = 8D								
GTO MKP = GTOM				305 VAC = AW		100 µF = 6100			35x50x57 PCM 52.5 = 9F								
DC-LINK MKP 3 = DCP3				400 VAC = 3W		220 µF = 6220			...								
DC-LINK MKP 4 = DCP4				440 VAC = 4W		1000 µF = 7100											
DC-LINK MKP 4S = DCP4S				500 VAC = 5W		1500 µF = 7150											
DC-LINK MKP 5 = DCP5														
DC-LINK MKP 6 = DCP6																	
DC-LINK HC = DCHC																	
									Version code:		Pin length (untaped)						
									Standard = 00		3.5 ±0.5 = C9						
									Version A1 = 1A		6-2 = SD						
									Version A1.1.1 = 1B		16 ±1 = P1						
									Version A2 = 2A		...						
									...								

The data on this page is not complete and serves only to explain the part number system. Part number information is listed on the pages of the respective WIMA range.