

524258000

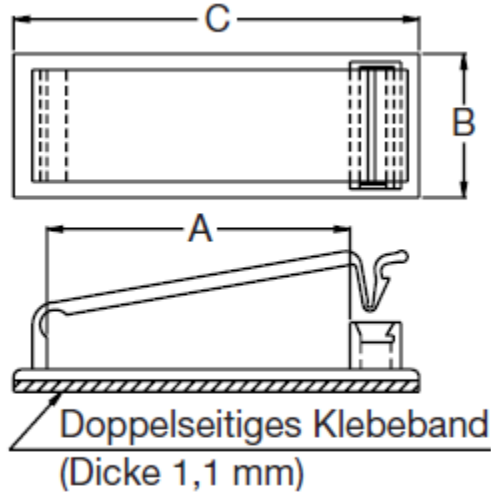

A	B	C	D
64.0	19.7	77.6	12.8

524258000

Material: Nylon 6.6 UL94V2

MINI SPACER STUD

Colour: natural

 Drawn
 Mark Wirth
 2010-01-21

 Last Update
 Mark Wirth
 2010-03-24

Würth Elektronik eiSos GmbH & Co KG
 D – 74638 Waldenburg
 Max-Eyth-Straße 1
 Tel.: 0049 7942-945-0 / Fax: 0049 7942-945-400
www.we-online.de