

1

2

3

4

5

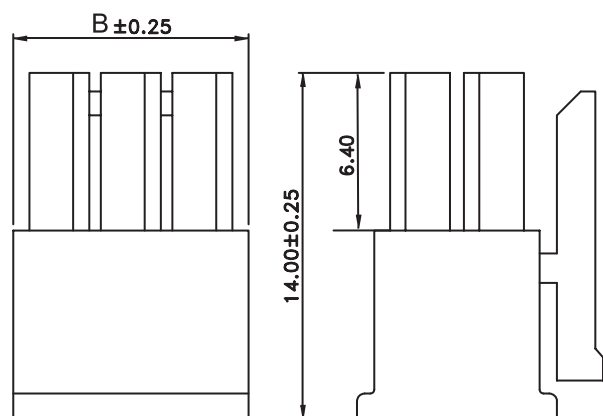
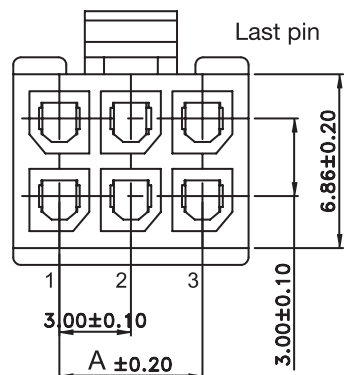

TECHNICAL CHARACTERISTICS

MATERIAL

INSULATOR: NYLON 6T
 FLAMABILITY RATING: UL94-V0
 COLOR: BLACK
 PITCH: 3.00MM

ENVIRONMENTAL

OPERATING TEMPERATURE: -25 UP TO 105°C
 COMPLIANCE: LEAD FREE AND ROHS

ELECTRICAL

CURRENT RATING: 5A
 WORKING VOLTAGE: 250V AC
 INSULATOR RESISTANCE: >1000 MOHM
 DIELECTRIC WITHSTANDING VOLTAGE: 1500V AC/MN

STANDARD

 CERTIFIED: E323964 / MODEL NUMBER 662-1133



PACKAGING

BAG

DIMENSION

A = 3.00 x (NB. PIN / 2 - 1)
 B = 3.00 x (NB. PIN / 2) + 0.85

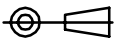
RoHS Compliant

G				PROJECTION: 	GENERAL TOLERANCE .X = +/- 0.2 .XX = +/- 0.15	 WÜRTH ELEKTRONIK	
F							
E							
D							
C	14-SEP-10	DIMENSION	GG	APPROVAL: RJ	UNIT: MM	DESCRIPTION: 3.00MM FEMALE DUAL ROW RECEPTACLE	SIZE A4
B	18-NOV-09	STANDARD	JP		SCALE:		
A	23-AVR-09	PACKAGING	JC		SHEET: 1/2	WERI PART NO: 662 0xx 113 322	
REV	DATE	FILE	BY		DRAW: PEARL		

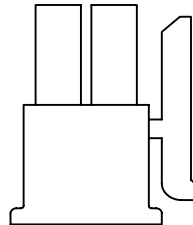
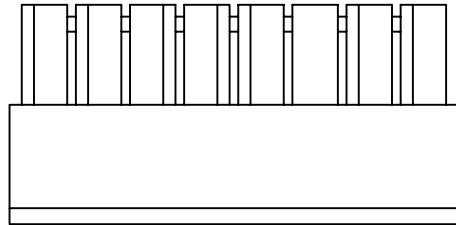
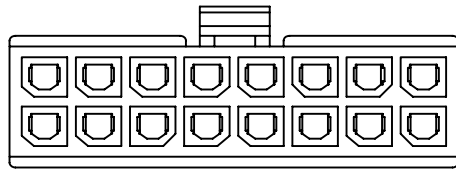

Note:

1.Dimension

Carton Size:400*280*280(MM)_n

2.Quantity:

Pin.	Pcs/Bag	Pcs/Carton
2	1000	24000
4	1000	24000
6	1000	22000
8	1000	22000
10	1000	20000
12	1000	20000
14	1000	18000
16	1000	18000
18	1000	15000
20	1000	15000
22	1000	12000
24	1000	12000

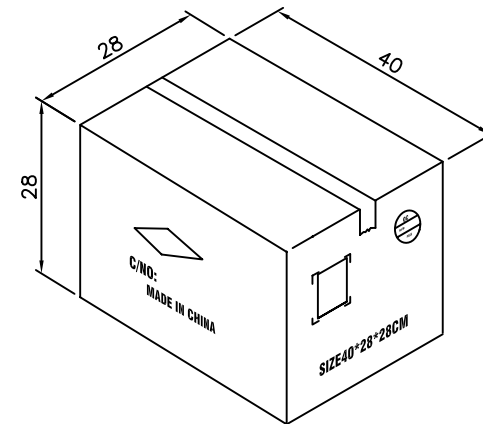
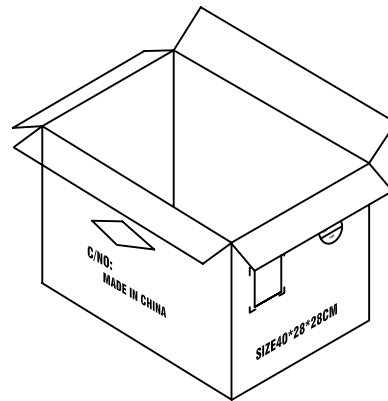
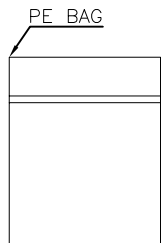

RoHS Compliant

G			
F			
E			
D			
C			
B			
A			
REV	DATE	FILE	BY

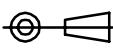
PROJECTION:

GENERAL TOLERANCE
 .X = +/- 0.2
 .XX = +/- 0.15



APPROVAL: RJ

UNIT: MM
 SCALE:
 SHEET: 2/2
 DRAW: PEARL

DESCRIPTION: 3.00MM FEMALE DUAL ROW RECEPTACLE
 WERI PART NO: 6620 xx 113322_TPK

SIZE
A4