

PCB LAYOUT - COMPONENT VIEW

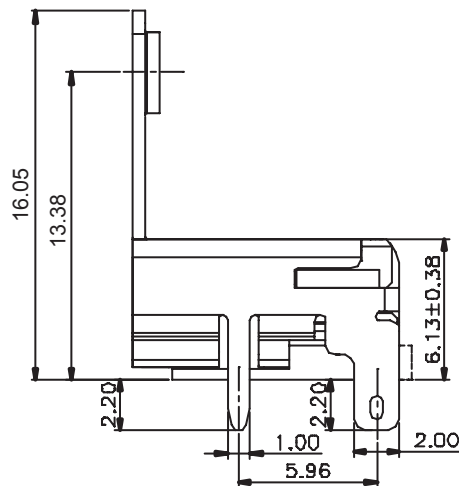
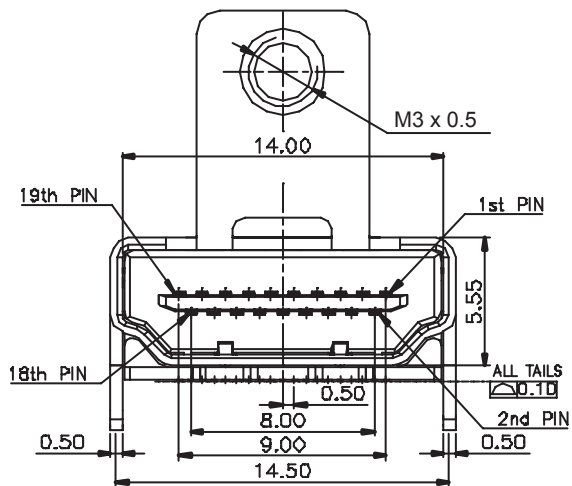

TECHNICAL CHARACTERISTICS

MATERIAL
 INSULATOR MATERIAL: LCP
 COLOUR: BLACK
 CONTACT MATERIAL: PHOSPHORE BRONZE
 CONTACT TYPE: STAMPED
 CONTACT PLATING: SELECTIVE GOLD
 SHIELDING: BRASS TIN PLATED
 QUALITY CLASS: 1500 MATING CYCLES

ENVIRONMENTAL
 OPERATING TEMPERATURE: -25 °C UP TO 85 °C
 FLAMMABILITY RATING UL94-V0
 COMPLIANCE: LEAD FREE AND ROHS

ELECTRICAL
 CURRENT RATING: 0.5 A
 WORKING VOLTAGE: 40 VAC
 INSULATION RESISTANCE: >100 mOHM
 DIELECTRIC WITHSTANDING VOLTAGE: 500 VAC/MN
 CONTACT RESISTANCE: 30 mOHM MAX

STANDARD
 CERTIFIED: E323964

SOLDERING
 JEDEC LEAD FREE REFLOW SOLDERING PROCESS

PACKAGING
 TRAY

RoHS Compliant

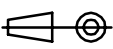
G				PROJECTION: 
F	24-NOV-15	UL CERTIFICATION	AK	
E	09-NOV-11	QUALITY CLASS	GG	
D	05-OCT-10	SHIELDING	JC	
C	08-JUL-10	PACKAGING	JC	
B	05-DEC-07	MODIFICATIONS	EC	APPROVAL: NPr
A	20-NOV-07	PDF	EC	
REV	DATE	FILE	BY	

GENERAL TOLERANCE

.X = +/- 0.2

.XX = +/- 0.15



UNIT: MM

SCALE:

SHEET: 1/3

DRAW: PEARL

DESCRIPTION: ANGLED SMT HDMI M3 SCREW



WERI PART NO: 685 119 135 725

SIZE

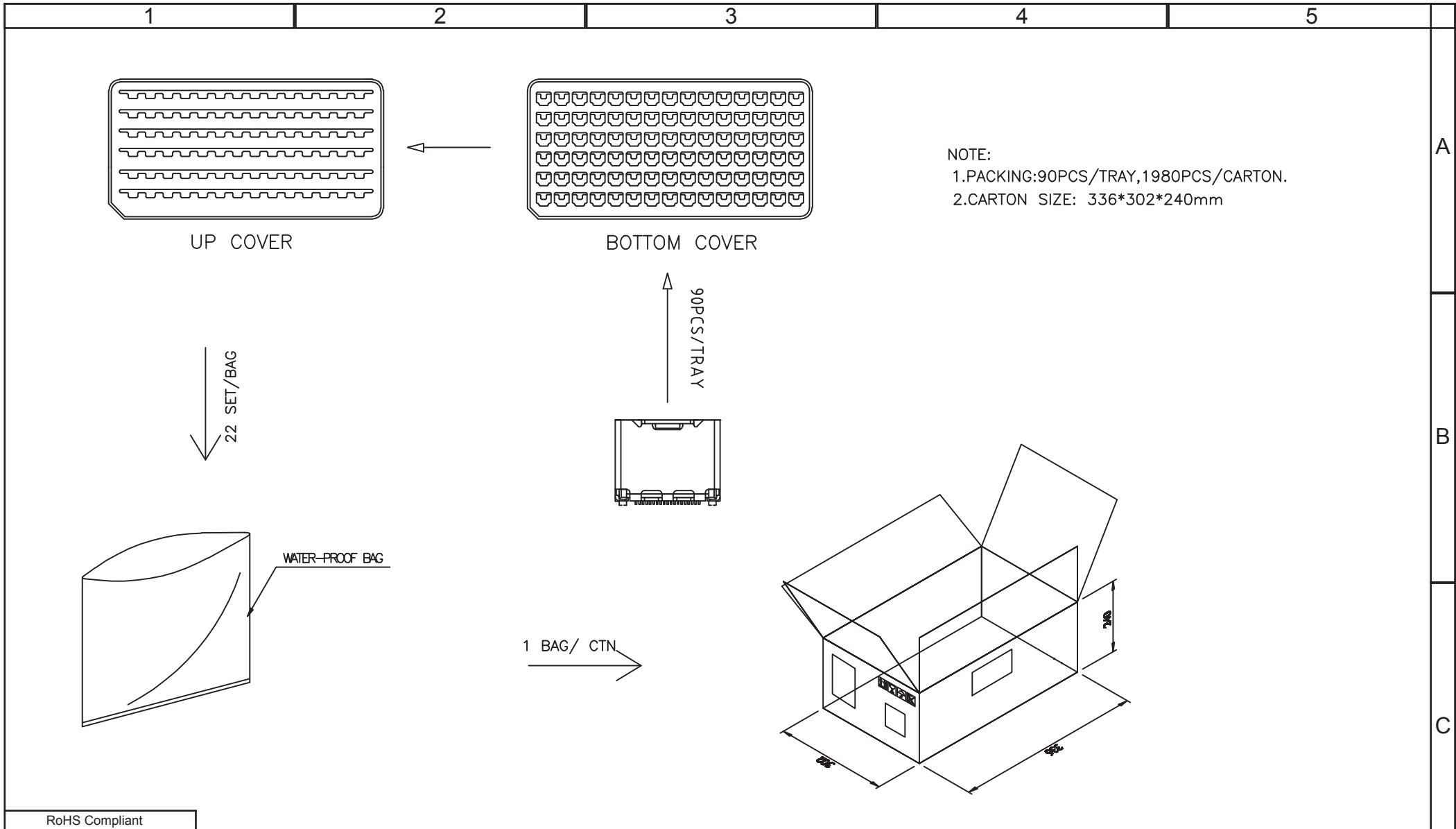
A4

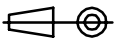

NOTE:
 1.PACKING:90PCS/TRAY,1980PCS/CARTON.
 2.CARTON SIZE: 336*302*240mm

RoHS Compliant				PROJECTION: 	GENERAL TOLERANCE .X = ± 0.2 .XX = ± 0.15		DESCRIPTION: ANGLED SMT HDMI M3 SCREW	SIZE A4
G								
F								
E								
D				APPROVAL: NPr	UNIT: MM	WERI PART NO: 685 119 135 725		
C					SCALE:			
B					SHEET: 2/3			
A				DRAW: PEARL				
REV	DATE	FILE	BY					

1

2

3

4

5

Cautions and Warnings:

This electronic component is designed and developed with the intention for use in general electronics equipments.

Before incorporating the components into any equipments in the field such as aerospace, aviation, nuclear control, submarine, transportation, (automotive control, train control, ship control), transportation signal, disaster prevention, medical, public information network etc. where higher safety and reliability are especially required or if there is possibility of direct damage or injury to human body, Würth Elektronik must be asked for a written approval.

In addition, even electronic component in general electronic equipments, when used in electrical circuits that require high safety, reliability functions or performance, the sufficient reliability evaluation-check for the safety must be performed before by the user before usage.

A

B

C

RoHS Compliant

PROJECTION:



GENERAL TOLERANCE

.X = +/- 0.2

.XX = +/- 0.15



APPROVAL: JC

UNIT: MM

SCALE:

SHEET: 3/3

DRAW: QL



DESCRIPTION: DISCLAIMER

WERI PART NO: DISCLAIMER

SIZE

A4

D

G				PROJECTION: 	GENERAL TOLERANCE .X = +/- 0.2 .XX = +/- 0.15	
F						
E						
D						
C				APPROVAL: JC	UNIT: MM	DESCRIPTION: DISCLAIMER
B					SCALE:	
A	10-SEP-14	PDF	QL		SHEET: 3/3	WERI PART NO: DISCLAIMER
REV	DATE	FILE	BY		DRAW: QL	