









WR-FPC - FPC Connector

| | | |
|---|---|--------------|
|  | 1.00 mm SMT ZIF Horizontal Bottom Contact | 02-2 |
|  | 1.00 mm SMT ZIF Horizontal Top Contact | 02-3 |
|  | 1.00 mm SMT ZIF Vertical Type | 02-4 |
|  | 0.50 mm SMT ZIF Horizontal Bottom Contact | 02-5 |
|  | 0.50 mm SMT ZIF Horizontal Top Contact | 02-6 |
|  | 0.50 mm SMT ZIF Vertical Type A & B | 02-7 to 02-8 |

02



WR-FPC 1.00mm SMT ZIF Horizontal Bottom Contact

02

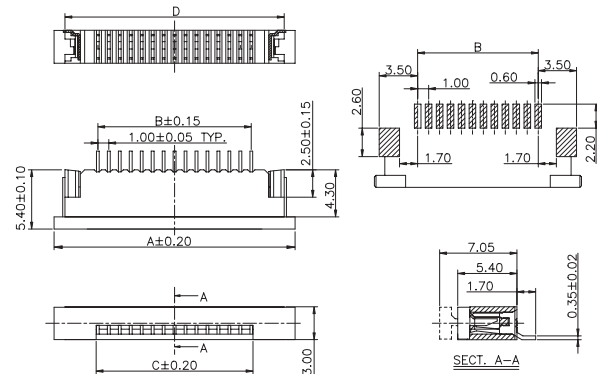

MATERIAL

- Housing material: PPS
- Colour: Beige
- Actuator material: PPS
- Colour: Brown
- Max temperature: 260 °C 10 s
- Contact material: Phosphor bronze
- Contact plating: 100µ Tin over 50µ Ni
- Quality class: 25 Mating cycles
- Pitch: 1.00 mm

ENVIRONMENTAL

- Operating temperature: -25 °C up to 85 °C
- Flammability rating: UL94-V0
- Compliance: Lead free and RoHS

ELECTRICAL

- Current rating: 0.5 A
- Working voltage: 50 V
- Insulation resistance: >100 MOhm
- Dielectric withstanding voltage: 500 Vac/mn
- Contact resistance: 20 mOhm max

SOLDERING

- Solder temperature: JEDEC lead free reflow soldering

PACKAGING

- Tape & Reel

| Order Code | Pins | A (mm) | B (mm) | C (mm) | D (mm) |
|-------------|------|--------|--------|--------|--------|
| 68610414422 | 4 | 11.0 | 3.0 | 5.15 | 9.0 |
| 68610614422 | 6 | 13.0 | 5.0 | 7.15 | 11.0 |
| 68610814422 | 8 | 15.0 | 7.0 | 9.15 | 13.0 |
| 68611014422 | 10 | 17.0 | 9.0 | 11.15 | 15.0 |
| 68611214422 | 12 | 19.0 | 11.0 | 13.15 | 17.0 |
| 68611414422 | 14 | 21.0 | 13.0 | 15.15 | 19.0 |
| 68611614422 | 16 | 23.0 | 15.0 | 17.15 | 21.0 |
| 68611814422 | 18 | 25.0 | 17.0 | 19.15 | 23.0 |
| 68612014422 | 20 | 27.0 | 19.0 | 21.15 | 25.0 |
| 68612214422 | 22 | 29.0 | 21.0 | 23.15 | 27.0 |
| 68612414422 | 24 | 31.0 | 23.0 | 25.15 | 29.0 |
| 68612614422 | 26 | 33.0 | 25.0 | 27.15 | 31.0 |
| 68612814422 | 28 | 36.0 | 28.0 | 30.15 | 34.0 |
| 68613014422 | 30 | 37.0 | 29.0 | 31.15 | 35.0 |

WR-FPC 1.00mm SMT ZIF Horizontal Top Contact

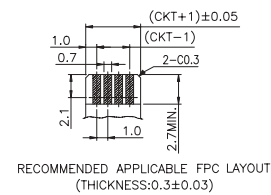
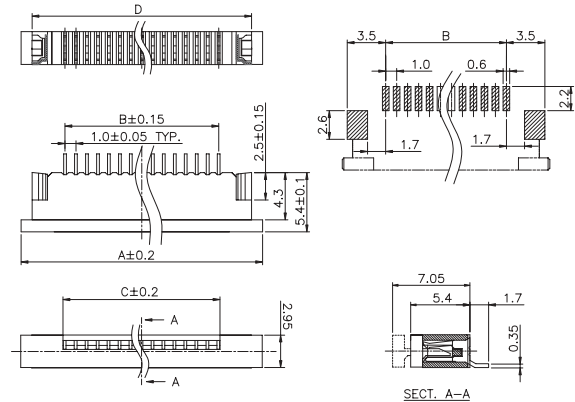

MATERIAL

- Housing material: PPS
- Colour: Beige
- Actuator material: PPS
- Colour: Brown
- Max temperature: 260 °C 10 s
- Contact material: Phosphor bronze
- Contact plating: 100µ Tin over 50µ Ni
- Quality class: 25 Mating cycles
- Pitch: 1.00 mm

ENVIRONMENTAL

- Operating temperature: -25 °C up to 85 °C
- Flammability rating: UL94-V0
- Compliance: Lead free and RoHS

ELECTRICAL

- Current rating: 0.5 A
- Working voltage: 50 V
- Insulation resistance: >100 MOhm
- Dielectric withstanding voltage: 500 Vac/mn
- Contact resistance: 20 mOhm max

SOLDERING

- Solder temperature: JEDEC lead free reflow soldering

PACKAGING

- Tape & Reel

| Order Code | Pins | A (mm) | B (mm) | C (mm) | D (mm) |
|-------------|------|--------|--------|--------|--------|
| 68610414122 | 4 | 11.0 | 3.0 | 5.15 | 9.0 |
| 68610614122 | 6 | 13.0 | 5.0 | 7.15 | 11.0 |
| 68610814122 | 8 | 15.0 | 7.0 | 9.15 | 13.0 |
| 68611014122 | 10 | 17.0 | 9.0 | 11.15 | 15.0 |
| 68611214122 | 12 | 19.0 | 11.0 | 13.15 | 17.0 |
| 68611414122 | 14 | 21.0 | 13.0 | 15.15 | 19.0 |
| 68611614122 | 16 | 23.0 | 15.0 | 17.15 | 21.0 |
| 68611814122 | 18 | 25.0 | 17.0 | 19.15 | 23.0 |
| 68612014122 | 20 | 27.0 | 19.0 | 21.15 | 25.0 |
| 68612214122 | 22 | 29.0 | 21.0 | 23.15 | 27.0 |
| 68612414122 | 24 | 31.0 | 23.0 | 25.15 | 29.0 |
| 68612614122 | 26 | 33.0 | 25.0 | 27.15 | 31.0 |
| 68612814122 | 28 | 36.0 | 28.0 | 30.15 | 34.0 |
| 68613014122 | 30 | 37.0 | 29.0 | 31.15 | 35.0 |

WR-FPC 1.00mm SMT ZIF Vertical Type A

02

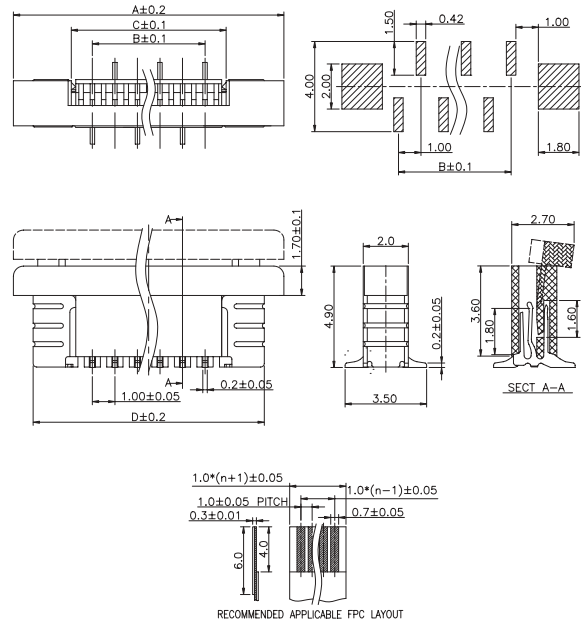

MATERIAL

- Housing material: LCP
- Colour: Nature
- Actuator material: LCP
- Colour: Black
- Max temperature: 260 °C 10 s
- Contact material: Phosphor bronze
- Contact plating: 100µ Tin over 50µ Ni
- Quality class: 25 Mating cycles
- Pitch: 1.00 mm

ENVIRONMENTAL

- Operating temperature: -25 °C up to 85 °C
- Flammability rating: UL94-V0
- Compliance: Lead free and RoHS

ELECTRICAL

- Current rating: 0.5 A
- Working voltage: 50 V
- Insulation resistance: >100 MOhm
- Dielectric withstanding voltage: 500 Vac/mn
- Contact resistance: 20 mOhm max

SOLDERING

- Solder temperature: JEDEC lead free reflow soldering

PACKAGING

- Tape & Reel

| Order Code | Pins | A (mm) | B (mm) | C (mm) | D (mm) |
|--------------|------|--------|--------|--------|--------|
| 686104124422 | 4 | 10.0 | 3.0 | 5.0 | 8.85 |
| 686106124422 | 6 | 12.0 | 5.0 | 7.0 | 10.85 |
| 686108124422 | 8 | 14.0 | 7.0 | 9.0 | 12.85 |
| 686110124422 | 10 | 16.0 | 9.0 | 11.0 | 14.85 |
| 686110124422 | 12 | 18.0 | 11.0 | 13.0 | 16.85 |
| 686114124422 | 14 | 20.0 | 13.0 | 15.0 | 18.85 |
| 686116124422 | 16 | 22.0 | 15.0 | 17.0 | 20.85 |
| 686118124422 | 18 | 24.0 | 17.0 | 19.0 | 22.85 |
| 686120124422 | 20 | 26.0 | 19.0 | 21.0 | 24.85 |
| 686122124422 | 22 | 28.0 | 21.0 | 23.0 | 33.85 |
| 686124124422 | 24 | 30.0 | 23.0 | 25.0 | 35.85 |

WR-FPC 0.5mm SMT ZIF Horizontal Bottom Contact

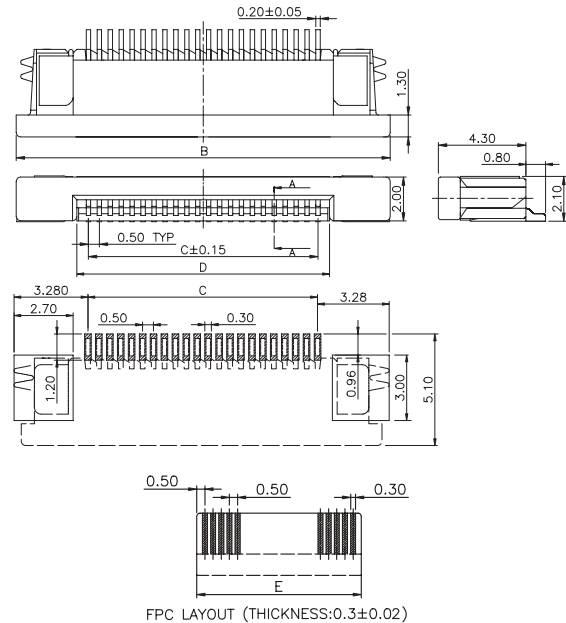

02



MATERIAL

- Housing material: LCP
- Colour: Ivory
- Actuator material: LCP
- Colour: Black
- Max temperature: 260 °C 10 s
- Contact material: Phosphor bronze
- Contact plating: 100µ Tin over 50µ Ni
- Quality class: 25 Mating cycles
- Pitch: 0.50 mm

ENVIRONMENTAL

- Operating temperature: -25 °C up to 85 °C
- Flammability rating: UL94-V0
- Compliance: Lead free and RoHS

ELECTRICAL

- Current rating: 0.3 A
- Working voltage: 25 V
- Insulation resistance: >100 MOhm
- Dielectric withstanding voltage: 500 Vac/mn
- Contact resistance: 20 mOhm max

SOLDERING

- Solder temperature: JEDEC lead free reflow soldering

PACKAGING

- Tape & Reel

| Order Code | Pins | B (mm) | C (mm) | D (mm) | E (mm) |
|-------------|------|--------|--------|--------|--------|
| 68710414522 | 4 | 8.4 | 1.5 | 2.6 | 2.5 |
| 68710614522 | 6 | 9.4 | 2.5 | 3.6 | 3.5 |
| 68710814522 | 8 | 10.4 | 3.5 | 4.6 | 4.5 |
| 68711014522 | 10 | 11.4 | 4.5 | 5.6 | 5.5 |
| 68711214522 | 12 | 12.4 | 5.5 | 6.6 | 6.5 |
| 68711414522 | 14 | 13.4 | 6.5 | 7.6 | 7.5 |
| 68711614522 | 16 | 14.4 | 7.5 | 8.6 | 8.5 |
| 68711814522 | 18 | 15.4 | 8.5 | 9.6 | 9.5 |
| 68712014522 | 20 | 16.4 | 9.5 | 10.6 | 10.5 |
| 68712214522 | 22 | 17.4 | 10.5 | 11.6 | 11.5 |
| 68712414522 | 24 | 18.4 | 11.5 | 12.6 | 12.5 |
| 68712614522 | 26 | 19.4 | 12.5 | 13.6 | 13.5 |
| 68712814522 | 28 | 20.4 | 13.5 | 14.6 | 14.5 |
| 68713014522 | 30 | 21.4 | 14.4 | 15.6 | 15.5 |
| 68714014522 | 40 | 26.4 | 19.5 | 20.6 | 20.5 |
| 68715014522 | 50 | 31.4 | 24.5 | 25.6 | 25.5 |

WR-FPC 0.5mm SMT ZIF Horizontal Top Contact

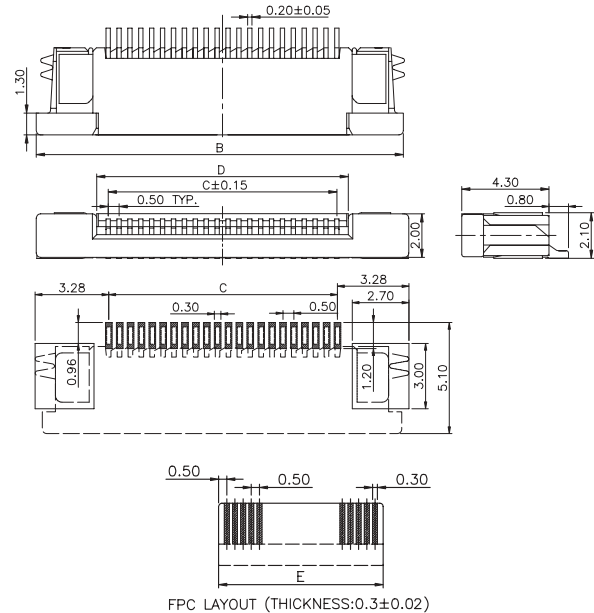

MATERIAL

- Housing material: LCP
- Colour: Ivory
- Actuator material: LCP
- Colour: Black
- Max temperature: 260 °C 10 s
- Contact material: Phosphor bronze
- Contact plating: 100µ Tin over 50µ Ni
- Quality class: 25 Mating cycles
- Pitch: 0.50 mm

ENVIRONMENTAL

- Operating temperature: -25 °C up to 85 °C
- Flamability rating: UL94-V0
- Compliance: Lead free and RoHS

ELECTRICAL

- Current rating: 0.3 A
- Working voltage: 25 V
- Insulation resistance: >100 MOhm
- Dielectric withstanding voltage: 500 Vac/mn
- Contact resistance: 20 mOhm max

SOLDERING

- Solder temperature: JEDEC lead free reflow soldering

PACKAGING

- Tape & Reel

| Order Code | Pins | B (mm) | C (mm) | D (mm) | E (mm) |
|-------------|------|--------|--------|--------|--------|
| 68710414022 | 4 | 8.4 | 1.5 | 2.6 | 2.5 |
| 68710614022 | 6 | 9.4 | 2.5 | 3.6 | 3.5 |
| 68710814022 | 8 | 10.4 | 3.5 | 4.6 | 4.5 |
| 68711014022 | 10 | 11.4 | 4.5 | 5.6 | 5.5 |
| 68711214022 | 12 | 12.4 | 5.5 | 6.6 | 6.5 |
| 68711414022 | 14 | 13.4 | 6.5 | 7.6 | 7.5 |
| 68711614022 | 16 | 14.4 | 7.5 | 8.6 | 8.5 |
| 68711814022 | 18 | 15.4 | 8.5 | 9.6 | 9.5 |
| 68712014022 | 20 | 16.4 | 9.5 | 10.6 | 10.5 |
| 68712214022 | 22 | 17.4 | 10.5 | 11.6 | 11.5 |
| 68712414022 | 24 | 18.4 | 11.5 | 12.6 | 12.5 |
| 68712614022 | 26 | 19.4 | 12.5 | 13.6 | 13.5 |
| 68712814022 | 28 | 20.4 | 13.5 | 14.6 | 14.5 |
| 68713014022 | 30 | 21.4 | 14.4 | 15.6 | 15.5 |
| 68714014022 | 40 | 26.4 | 19.5 | 20.6 | 20.5 |
| 68715014022 | 50 | 31.4 | 24.5 | 25.6 | 25.5 |

WR-FPC 0.50mm SMT ZIF Vertical Type A

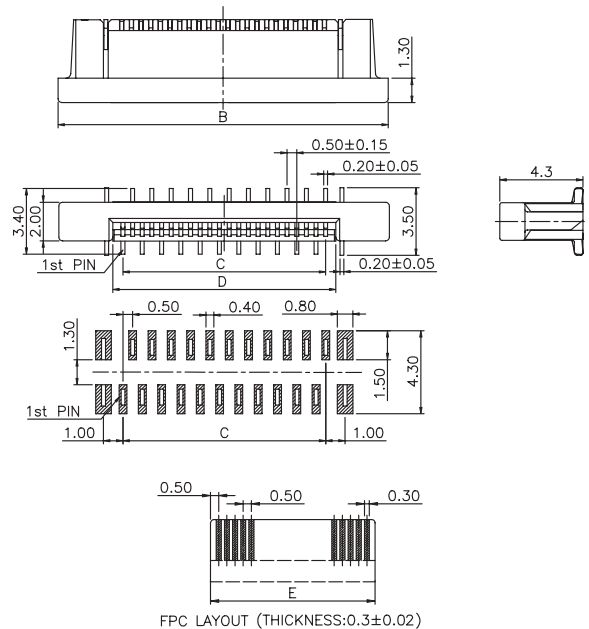

02



MATERIAL

- Housing material: LCP
- Colour: Ivory
- Actuator material: LCP
- Colour: Black
- Max temperature: 260 °C 10 s
- Contact material: Phosphor bronze
- Contact plating: 100µ Tin over 50µ Ni
- Quality class: 25 Mating cycles
- Pitch: 0.50 mm

ENVIRONMENTAL

- Operating temperature: -25 °C up to 85 °C
- Flamability rating: UL94-V0
- Compliance: Lead free and RoHS

ELECTRICAL

- Current rating: 0.3 A
- Working voltage: 25 V
- Insulation resistance: >100 MOhm
- Dielectric withstanding voltage: 500 Vac/mn
- Contact resistance: 20 mOhm max

SOLDERING

- Solder temperature: JEDEC lead free reflow soldering

PACKAGING

- Tape & Reel

| Order Code | Pins | B (mm) | C (mm) | D (mm) | E (mm) |
|--------------|------|--------|--------|--------|--------|
| 687104124422 | 4 | 8.4 | 1.5 | 2.6 | 2.5 |
| 687106124422 | 6 | 9.4 | 2.5 | 3.6 | 3.5 |
| 687108124422 | 8 | 10.4 | 3.5 | 4.6 | 4.5 |
| 687110124422 | 10 | 11.4 | 4.5 | 5.6 | 5.5 |
| 687112124422 | 12 | 12.4 | 5.5 | 6.6 | 6.5 |
| 687114124422 | 14 | 13.4 | 6.5 | 7.6 | 7.5 |
| 687116124422 | 16 | 14.4 | 7.5 | 8.6 | 8.5 |
| 687118124422 | 18 | 15.4 | 8.5 | 9.6 | 9.5 |
| 687120124422 | 20 | 16.4 | 9.5 | 10.6 | 10.5 |
| 687122124422 | 22 | 17.4 | 10.5 | 11.6 | 11.5 |
| 687124124422 | 24 | 18.4 | 11.5 | 12.6 | 12.5 |
| 687126124422 | 26 | 19.4 | 12.5 | 13.6 | 13.5 |
| 687128124422 | 28 | 20.4 | 13.5 | 14.6 | 14.5 |
| 687130124422 | 30 | 21.4 | 14.4 | 15.6 | 15.5 |
| 687140124422 | 40 | 26.4 | 19.5 | 20.6 | 20.5 |
| 687150124422 | 50 | 31.4 | 24.5 | 25.6 | 25.5 |

WR-FPC 0.50mm SMT ZIF Vertical Type B

02

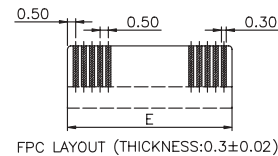
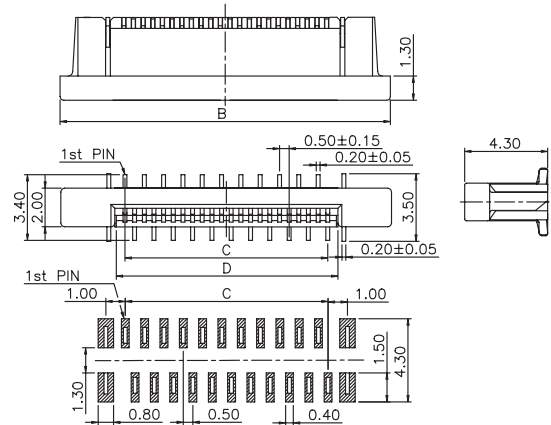

MATERIAL

- Housing material: LCP
- Colour: Ivory
- Actuator material: LCP
- Colour: Black
- Max temperature: 260 °C 10 s
- Contact material: Phosphor bronze
- Contact plating: 100µ Tin over 50µ Ni
- Quality class: 25 Mating cycles
- Pitch: 0.50 mm

ENVIRONMENTAL

- Operating temperature: -25 °C up to 85 °C
- Flamability rating: UL94-V0
- Compliance: Lead free and RoHS

ELECTRICAL

- Current rating: 0.3 A
- Working voltage: 25 V
- Insulation resistance: >100 MOhm
- Dielectric withstanding voltage: 500 Vac/mn
- Contact resistance: 20 mOhm max

SOLDERING

- Solder temperature: JEDEC lead free reflow soldering

PACKAGING

- Tape & Reel

| Order Code | Pins | B (mm) | C (mm) | D (mm) | E (mm) |
|--------------|------|--------|--------|--------|--------|
| 687104124322 | 4 | 8.4 | 1.5 | 2.6 | 2.5 |
| 687106124322 | 6 | 9.4 | 2.5 | 3.6 | 3.5 |
| 687108124322 | 8 | 10.4 | 3.5 | 4.6 | 4.5 |
| 687110124322 | 10 | 11.4 | 4.5 | 5.6 | 5.5 |
| 687112124322 | 12 | 12.4 | 5.5 | 6.6 | 6.5 |
| 687114124322 | 14 | 13.4 | 6.5 | 7.6 | 7.5 |
| 687116124322 | 16 | 14.4 | 7.5 | 8.6 | 8.5 |
| 687118124322 | 18 | 15.4 | 8.5 | 9.6 | 9.5 |
| 687120124322 | 20 | 16.4 | 9.5 | 10.6 | 10.5 |
| 687122124322 | 22 | 17.4 | 10.5 | 11.6 | 11.5 |
| 687124124322 | 24 | 18.4 | 11.5 | 12.6 | 12.5 |
| 687126124322 | 26 | 19.4 | 12.5 | 13.6 | 13.5 |
| 687128124322 | 28 | 20.4 | 13.5 | 14.6 | 14.5 |
| 687130124322 | 30 | 21.4 | 14.4 | 15.6 | 15.5 |
| 687140124322 | 40 | 26.4 | 19.5 | 20.6 | 20.5 |
| 687150124322 | 50 | 31.4 | 24.5 | 25.6 | 25.5 |