

1

2

3

4

5

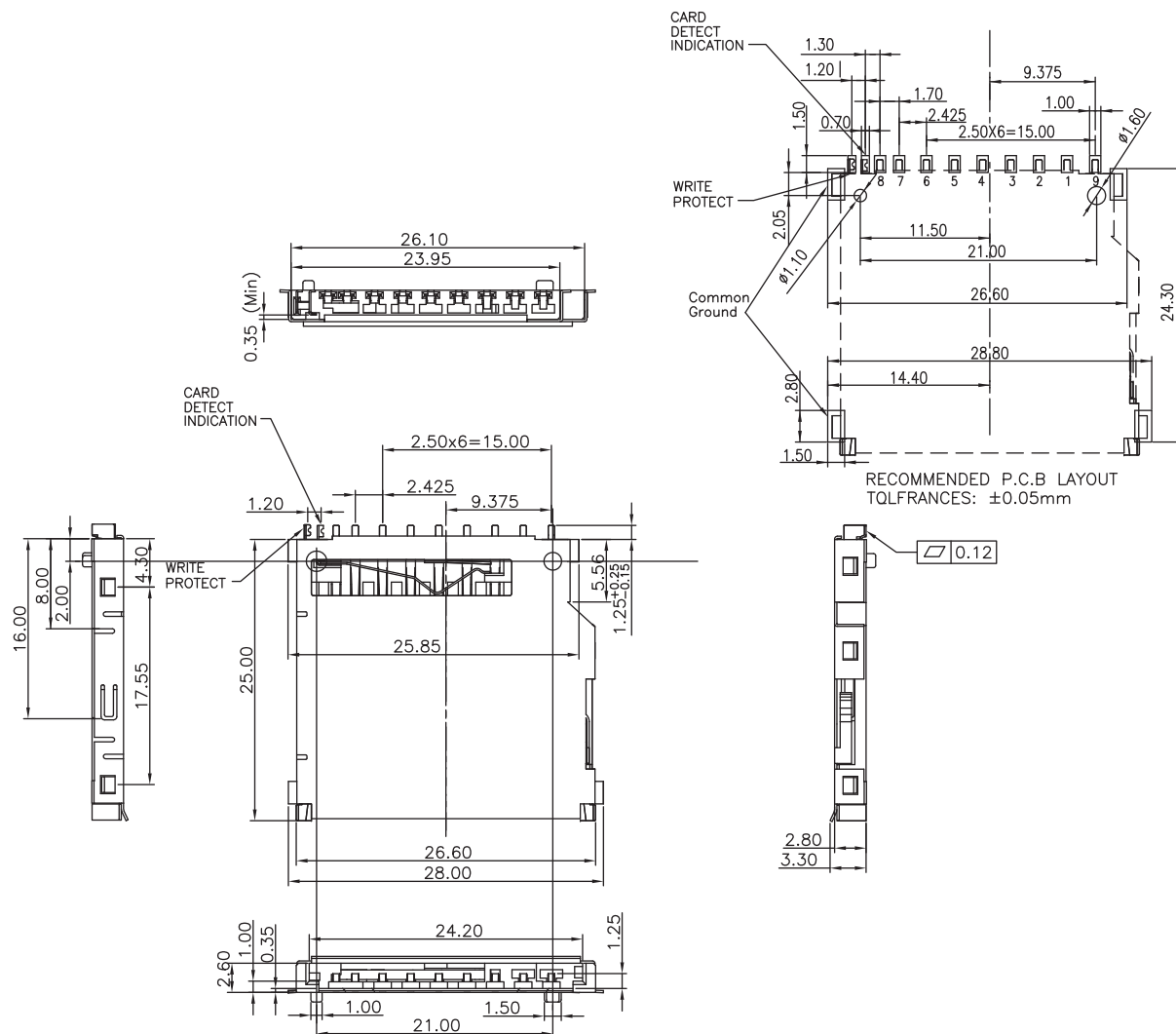

TECHNICAL CHARACTERISTICS

MATERIAL
 INSULATOR: LCP
 FLAMABILITY RATING: UL94-V0
 COLOR: BLACK
 CONTACT MATERIAL: COPPER ALLOY
 CONTACT TYPE: STAMPED
 CONTACT PLATING: SELECTIVE GOLD
 SHIELDING: COPPER ALLOY
 SHIELDING PLATING: NICKEL
 QUALITY CLASS: 10000 MATING CYCLES

ENVIRONMENTAL
 OPERATING TEMPERATURE: -25 UP TO 85°C
 COMPLIANCE: LEAD FREE AND ROHS

ELECTRICAL
 CURRENT RATING: 0.5A
 WORKING VOLTAGE: 100VAC
 INSULATOR RESISTANCE: >1000 MOHM
 DIELECTRIC WITHSTANDING VOLTAGE: 500VAC/MN
 CONTACT RESISTANCE: 100 mOHM MAX

SOLDERING
 REFLOW PROCESS ONLY

PACKAGING
 TAPE & REEL

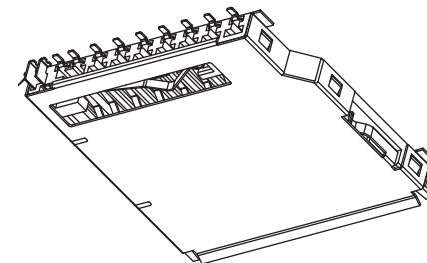

RoHS Compliant

PROJECTION:

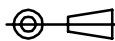

GENERAL TOLERANCE

.X = ± 0.2 .XX = ± 0.15 

APPROVAL: RJ

UNIT: MM

SCALE:

SHEET: 1/3

DRAW: VICKY

DESCRIPTION: SD Card Connector - Push & Pull - With Card Detection
 9 pins

WERI PART NO: 693 063 010 911

SIZE

A4

REV	DATE	FILE	BY
A	11-AUG-31	PDF	GG
B	16-FEB-12	TKP	GG
C	22-FEB-12	PAGE 2	GG
D	07-MAR-12	PAGE 2 SWITCH	GG

1

2

3

4

5

Contact OFF

Contact ON / Lock OFF

Contact ON / Lock ON



DETAIL L



K



DETAIL J



DETAIL K

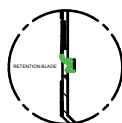

DETAIL N

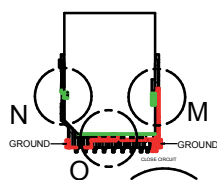

DETAIL O

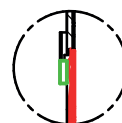

DETAIL M

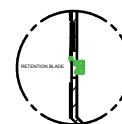

DETAIL Q

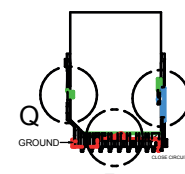

R

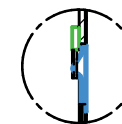

DETAIL P

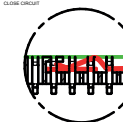

DETAIL R

Card detection switch		Write protection switch		
Card removed	Card inserted	Card removed	Card inserted	
			Write Protect	Write enable
OPEN	CLOSE	OPEN	OPEN	CLOSE

RoHS Compliant

PROJECTION:

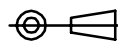

GENERAL TOLERANCE

.X = +/- 0.2

.XX = +/- 0.15



APPROVAL: RJ

UNIT: MM

SCALE:

SHEET: 2/3

DRAW: VICKY

DESCRIPTION: SD Card Connector - Push & Pull - With Card Detection
9 pins

WERI PART NO: 693 063 010 911

SIZE

A4

REV

DATE

FILE

BY

1

2

3

4

5

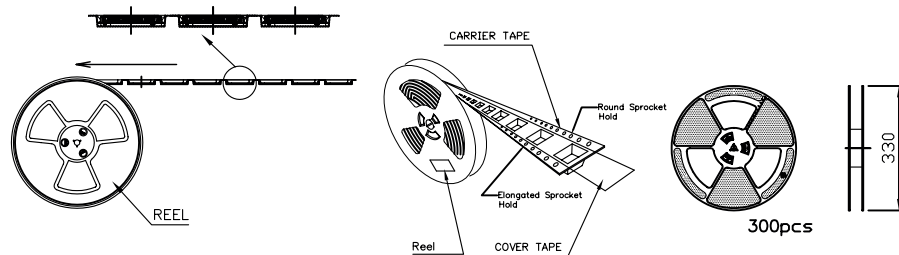
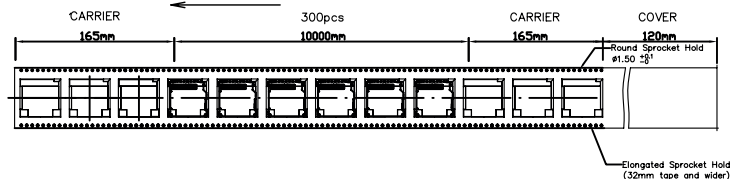
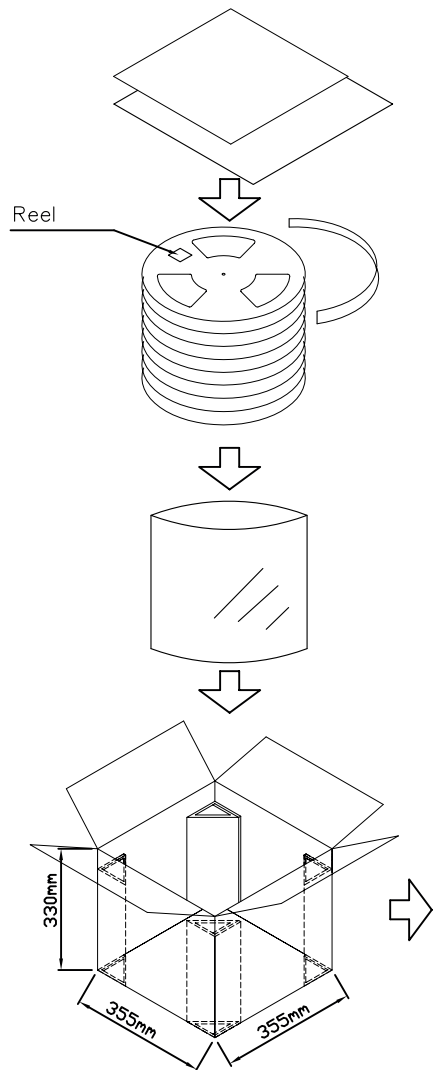

NOTES

1. MATERIALS: PS
2. PACKING: TAPE REEL(300PCS/R,1800PCS/CTN)
3. SONY SS-00259 or RoHS

All Material in According With The Rohs Environment Related Substances List Controlled.

RoHS Compliant

PROJECTION:

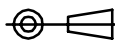

GENERAL TOLERANCE

.X = ± 0.2

.XX = ± 0.15



APPROVAL: RJ

UNIT: MM

SCALE:

SHEET: 3/3

DRAW: VICKY

DESCRIPTION: SD Card Connector - Push & Pull - With Card Detection
9 pins

WERI PART NO: 693 063 010 911

SIZE

A4

REV

DATE

FILE

BY