

Specification for release

Customer : _____
 Ordercode: **824022**
 Description: **TVS Diode Array WE-TVS**
 Package: **SOT23-3L**



DATUM / DATE : 2009-02-03

A Features:

- ESD Protection for 2 Lines - bidirectional
- Provide ESD Protection for each line to IEC 61000-4-2 (ESD) $\pm 15\text{kV}$ (air), $\pm 8\text{kV}$ (contact)
 IEC 61000-4-4 (EFT) 40A (5/50ns)
 IEC 61000-4-5 (Lightning) 8A (8/20 μs)
- Below 5V operating voltage: 2.5 - 3.3 - 4.2 - 5.0V
- Protect two I/O or Power Lines

Mechanical Characteristics:

- JEDEC SOT23-3L Package
- Molding compound flamability rating: UL94V-0
- Packaging: Tape & Reel

B Schematic and Pin Configuration:

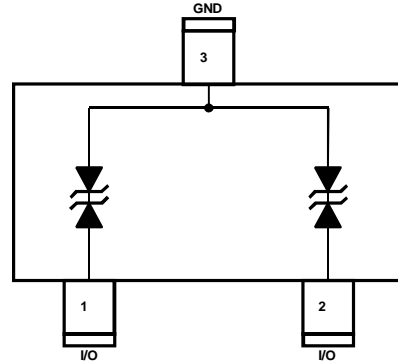

C Absolute Maximum Ratings:

	Symbol	Rating	Unit
Peak Pulse Current (tp = 8/20 μs)	I_{PP}	8	A
ESD per IEC 61000-4-2 (Air / Contact), I/O to GND	V_{ESD}	20 / 12	kV
Operating Temperature	T_{Op}	-55 to +125	$^{\circ}\text{C}$
Storage Temperature	T_{Sto}	-20 to +60	$^{\circ}\text{C}$

D Electrical Characteristics:

Properties	Test Conditions	Value min	Value typ	Value max	Unit
V_{RWM}	I/O to GND			5	V
V_{BV}	$I_{BV}=1\text{mA}$, I/O to GND	6.1			V
I_R	$V_{RWM}=5\text{V}$, I/O to GND			2.5	μA
V_C	$I_{PP}=5\text{A}$, tp=8/20 μs , I/O to GND		7	8	V
$V_{Cl,I/O}$	$I_{TLP} = 17\text{A}$, I/O to GND		9		V
$V_{Cl,VDD}$	$I_{TLP} = 17\text{A}$, I/O to I/O		11		V
C_{IO}	$V_{IO}=0\text{V}$, f=1MHz, I/O to GND		12	15	pF

Würth Elektronik eiSos GmbH & Co. KG

Specification for release

Customer : _____
Ordercode: **824022**
Description : **TVS Diode Array WE-TVS**



DATUM / DATE : 2009-02-03

E Typical Characteristics:

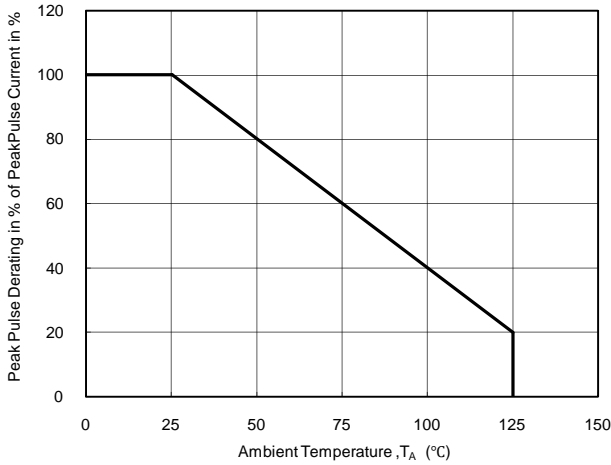

Power Derating Curve

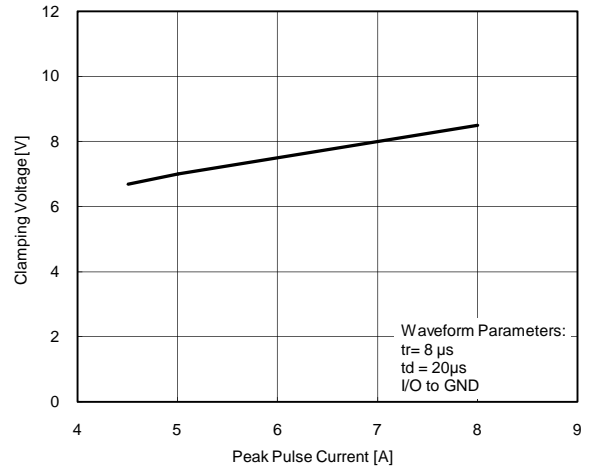

Clamping Voltage vs. Peak Pulse Current

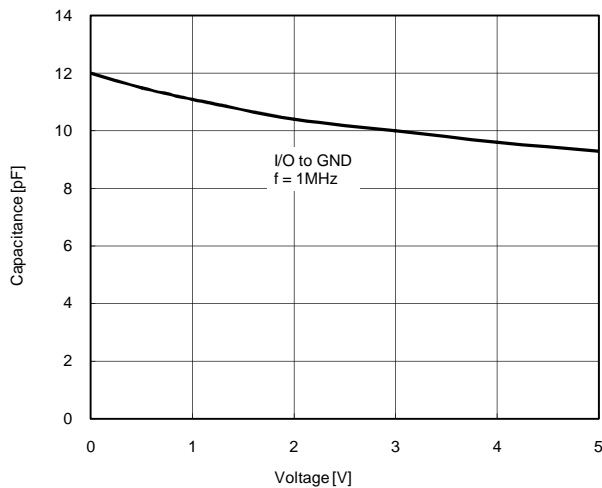

Variation of C_{10} vs. V_{10}

Specification for release

Customer : _____
 Ordercode: **824022**
 Description : **TVS Diode Array WE-TVS**



DATUM / DATE : 2009-02-03

E Typical Characteristic:

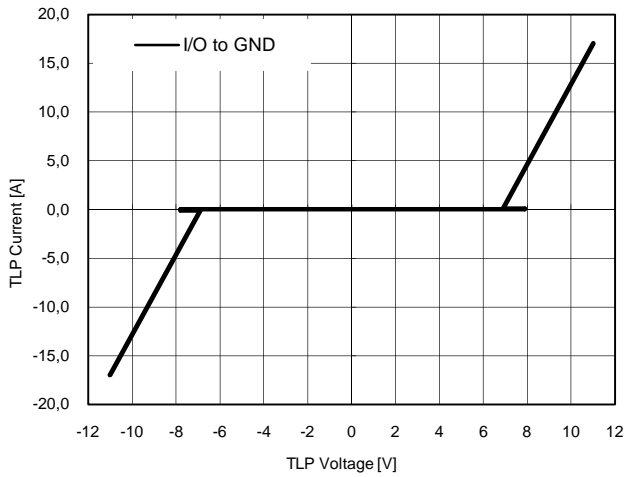

Transmission Line Pulsing (TLP) Measurement

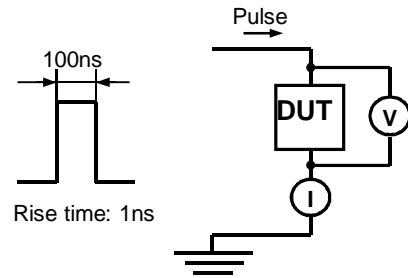

Transmission Line Pulsing System

F Recommended Land Layout:

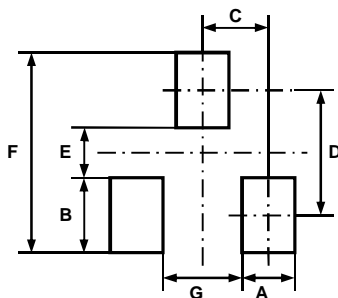

A	0.9	mm
B	1.4	mm
C	0.95	mm
D	2.1	mm
E	0.7	mm
F	3.5	mm
G	1.0	mm

G Body Marking:

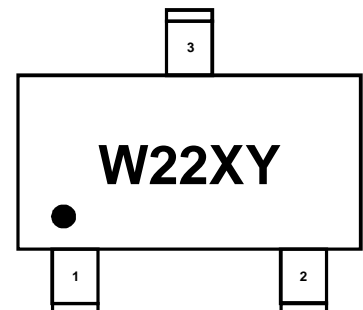

W22: Device Code

X: Date Code

Y: Control Code

Würth Elektronik eiSos GmbH & Co. KG

D-74638 Waldenburg · Max-Eyth-Strasse 1 · Germany · Phone (+49) (0) 7942 - 945 - 0 · Fax (+49) (0) 7942 - 945 - 400

<http://www.we-online.com>

PAGE 3 OF 5

Specification for release

Customer : _____
 Ordercode: **824022**
 Description : **TVS Diode Array WE-TVS**



DATUM / DATE : 2009-02-03

H Dimensions:

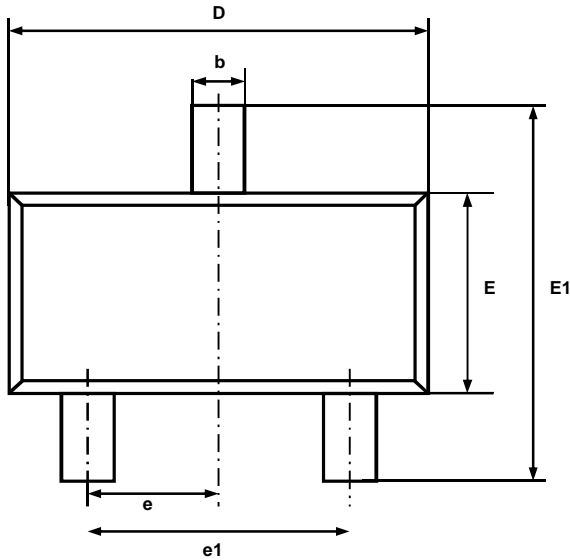

A	0.90 to 1.20	mm
A1	0.00 to 0.10	mm
A2	0.90 to 1.10	mm
b	0.30 to 0.50	mm
C	0.08 to 0.20	mm
D	2.90 BSC	mm
E	1.30 BSC	mm
E1	2.40 BSC	mm
e	0.95 BSC	mm
e1	1.90 BSC	mm
L	0.55 REF	mm
L1	0.30 to 0.50	mm
L2	0.25 BSC	mm
t	0 to 10	°

BSC = Basic Spacing between Centers

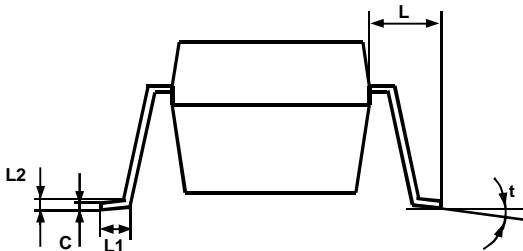
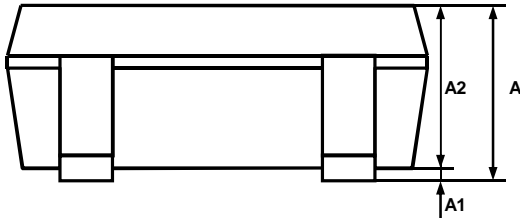

Würth Elektronik eiSos GmbH & Co. KG

D-74638 Waldenburg · Max-Eyth-Strasse 1 · Germany · Phone (+49) (0) 7942 - 945 - 0 · Fax (+49) (0) 7942 - 945 - 400

<http://www.we-online.com>

PAGE 4 OF 5

Specification for release

Customer : _____
 Ordercode: **824022**
 Description : **TVS Diode Array WE-TVS**



I Tape:

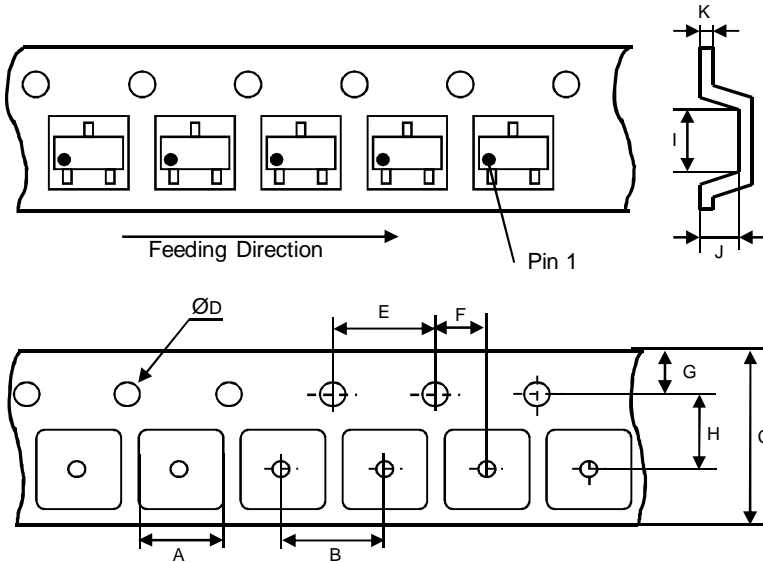

A	4.00 ± 0.10	mm
B	4.00 ± 0.10	mm
C	8.00 ± 0.20	mm
D	1.55 ± 0.05	mm
E	4.00 ± 0.10	mm
F	2.00 ± 0.05	mm
G	1.75 ± 0.10	mm
H	3.50 ± 0.05	mm
I	3.25 ± 0.15	mm
J	1.35 ± 0.15	mm
K	0.25 ± 0.02	mm

J Reel:

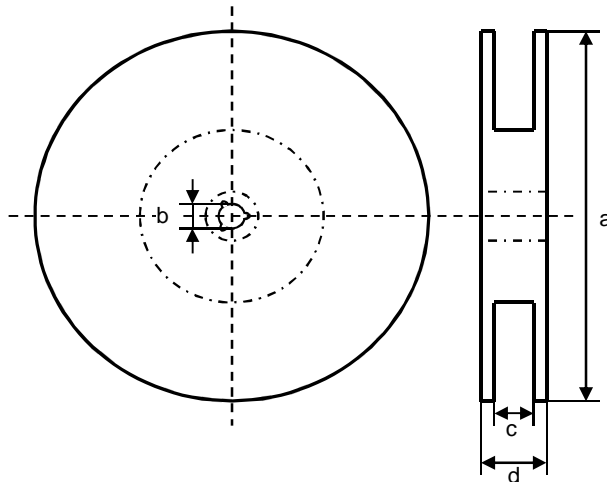

a	178.0 ± 2.0	mm
b	13.0 ± 0.8	mm
c	10.0 ± 1.5	mm
d	12.5 ± 2.0	mm

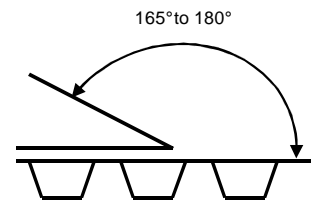

Quantity per Reel: 3000

General Release:	Customer			
	Date	Signature		
Checked	Würth Elektronik			
	Approved	Name	Modification	Date
		JB	Changed Name VDD to GND	2009-02-03
		JB	Version 1	2008-10-13

This electronic component has been designed and developed for usage in general electronic equipment. Before incorporating this component into any equipment where higher safety and reliability is especially required or if there is the possibility of direct damage or injury to human body, for example in the range of aerospace, aviation, nuclear control, submarine, transportation, (automotive control, train control, ship control), transportation signal, disaster prevention, medical, public information network etc, Würth Elektronik eiSos GmbH must be informed before the design-in stage. In addition, sufficient reliability evaluation checks for safety must be performed on every electronic component which is used in electrical circuits that require high safety and reliability functions or performance.

Würth Elektronik eiSos GmbH & Co. KG

D-74638 Waldenburg · Max-Eyth-Strasse 1 · Germany · Phone (+49) (0) 7942 - 945 - 0 · Fax (+49) (0) 7942 - 945 - 400

<http://www.we-online.com>