

Dimensions: [mm]

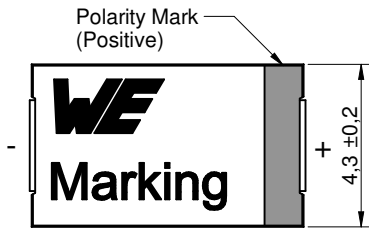

Scale - 5:1

Recommended Land Pattern: [mm]

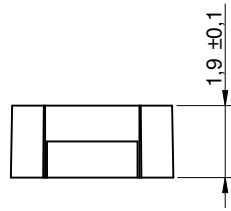
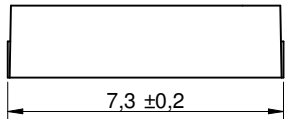
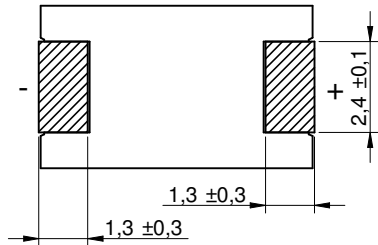
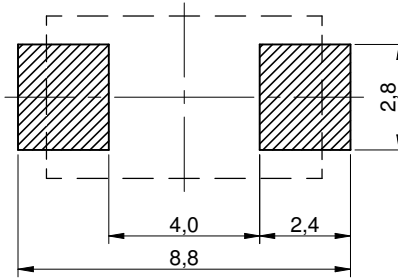

Scale - 5:1

Schematic:

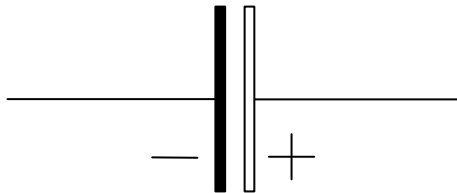

Electrical Properties:

Properties		Test conditions	Value	Unit	Tol.
Capacitance	C	0.5 V/ 120 Hz/ +20 °C	150	μF	±20%
Rated Voltage	V _R		6.3	V (DC)	max.
Surge Voltage	V _S	1000 cycles @ 20 °C	7.8	V (DC)	max.
Leakage Current	I _{Leak}	2 min./ +20 °C	94.5	μA	max.
Dissipation Factor	DF	0.5 V/ 120 Hz/ +20 °C	6	%	max.
Ripple Current	I _{RIPPLE}	100 kHz @ 45 °C	5600	mA	max.
ESR	R _{ESR}	100 kHz @ 20°C	12	mΩ	max.

General Information:

Aluminum Polymer Capacitors	
Storage Conditions (in original packaging)	5 °C - 30 °C; 10 % up to 70 % RH
Operating Temperature	-55 up to +105 °C
Endurance	2000 h
Moisture Sensitivity Level (MSL)	3
Test conditions of Electrical Properties: +20 °C, 35 % RH if not specified differently	
FIT according to separate documentation	
Surge Voltage: Charging time 30s, discharging time 330s for a cycle	
Component conform to REACH and RoHS requirements and standards	



Würth Elektronik eiSos GmbH & Co. KG
 EMC & Inductive Solutions
 Max-Eyth-Str. 1
 74638 Waldenburg
 Germany
 Tel. +49 (0) 79 42 945 - 0
 www.we-online.com
 eiSos@we-online.com

CHECKED PSL	REVISION 002.000	DATE (YYYY-MM-DD) 2019-10-02	GENERAL TOLERANCE DIN ISO 2768-1m	PROJECTION METHOD
DESCRIPTION WCAP-PHGP Aluminum Polymer Capacitors			TECHNICAL REFERENCE PSE2917151M6R3DHCT1HT19	
SIZE/TYPE 7.3 x 4.3 x 1.9			ORDER CODE 875015119004	
BUSINESS UNIT eiCap		STATUS Valid	PAGE 1/8	

Product Marking:

1 st Line left	WE Marking
1 st Line right	Capacitance Value 150 µF (Coding 150)
2 nd Line left	Lot Number
2 nd Line right	Rated Voltage: 6.3 V (DC) (Coding j)

Multiplier for Ripple Current vs. Frequency



Frequency	Multiplier
10 kHz ≤ freq. < 20 kHz	0.6
20 kHz ≤ freq. < 50 kHz	0.7
50 kHz ≤ freq. < 100 kHz	0.8
100 kHz ≤ freq. < 200 kHz	1.0
200 kHz ≤ freq. < 500 kHz	0.8
500 kHz ≤ freq. < 1 MHz	0.7
1 MHz ≤ freq. < 10 MHz	0.4

Multiplier for Ripple Current vs. Temperature

Temperature	Multiplier for 2 V _(DC) up to 6.3 V _(DC)	Multiplier for 10 V _(DC) up to 35 V _(DC)
T ≤ 45°C	1.0	1.0
45°C < T ≤ 85 °C	0.7	0.8
85°C < T ≤ 105 °C	0.25	0.5
105°C < T ≤ 125 °C		0.25 (WCAP-PHET)

Certification:

RoHS Approval	Compliant [2011/65/EU&2015/863]
REACH Approval	Conform or declared [(EC)1907/2006]
Halogen Free	Conform [JEDEC JS709B]
Halogen Free	Conform [IEC 61249-2-21]

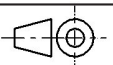
 	CHECKED PSL	REVISION 002.000	DATE (YYYY-MM-DD) 2019-10-02	GENERAL TOLERANCE DIN ISO 2768-1m	PROJECTION METHOD 
	DESCRIPTION WCAP-PHGP Aluminum Polymer Capacitors				TECHNICAL REFERENCE PSE2917151M6R3DHCT1HT19
	SIZE/TYPE 7.3 x 4.3 x 1.9				BUSINESS UNIT eiCap
WÜRTH Elektronik eiSos GmbH & Co. KG EMC & Inductive Solutions Max-Eyth-Str. 1 74638 Waldenburg Germany Tel. +49 (0) 79 42 945 - 0 www.we-online.com eiSos@we-online.com			STATUS Valid	PAGE 2/8	

Packaging Specification - Tape and Reel: [mm]

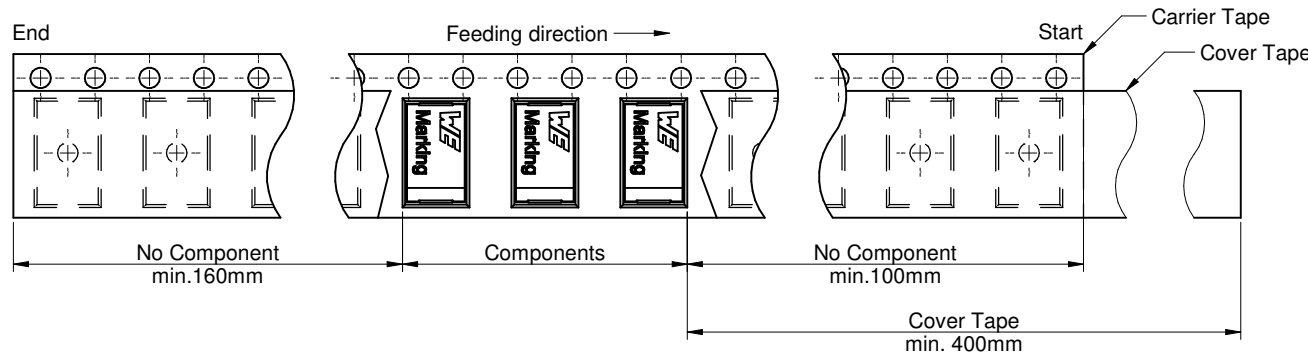
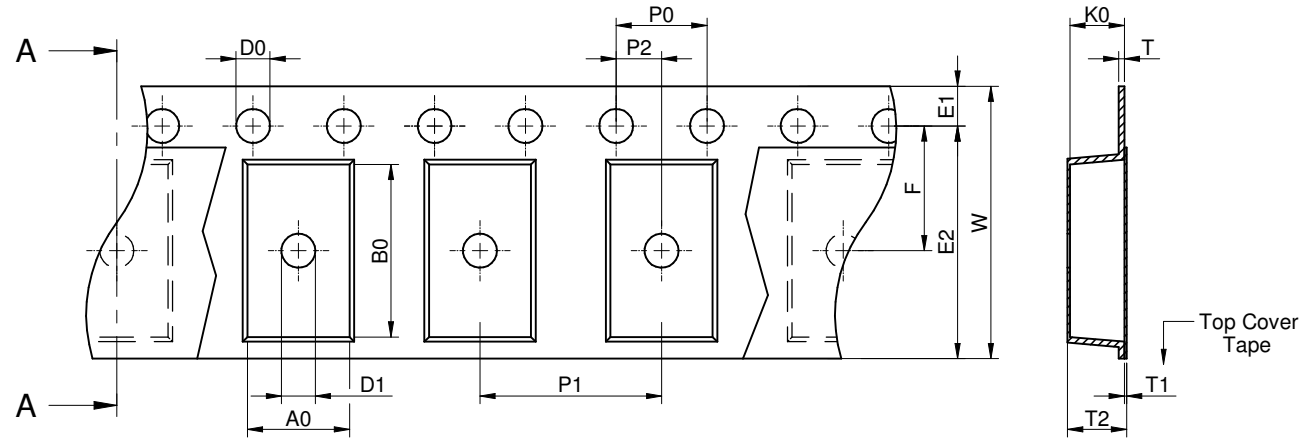

packaging is referred to the international standard IEC 60286-2

Tape Type	A0 (mm)	B0 (mm)	W (mm)	T (mm)	T1 (mm)	T2 (mm)	K0 (mm)	P0 (mm)	P1 (mm)	P2 (mm)	D0 (mm)	D1 (mm)	E1 (mm)	E2 (mm)	F (mm)	Material	Qty. (pcs.)
	typ.	typ.	+0,3/ -0,1	ref.	max.	typ.	typ.	±0,1	±0,1	±0,05	+0,1/ -0,0	min.	±0,1	min.	±0,05		
2a	4,50	7,60	12,00		0,10		2,40	4,00	8,00	2,00	1,50	1,50	1,75	10,25	5,50	Polystyrene	3500

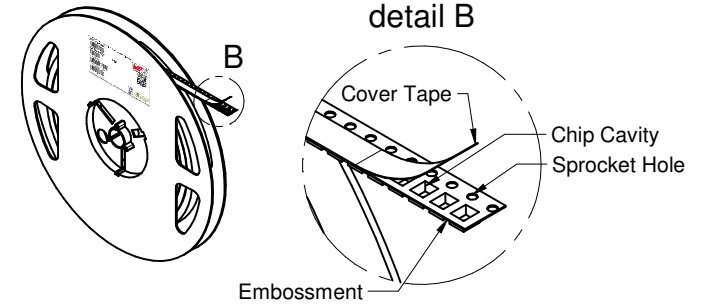
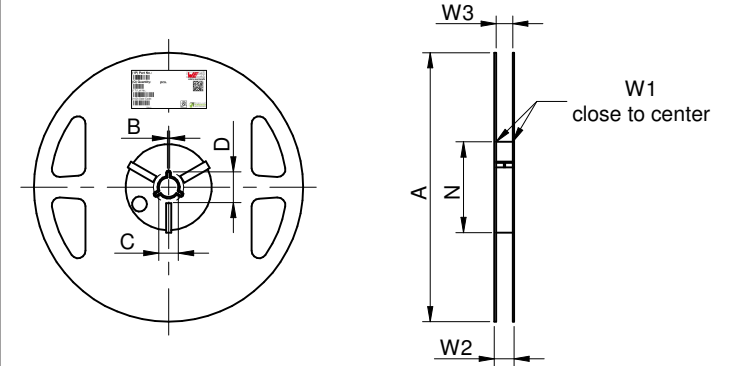

A (mm)	B (mm)	C (mm)	D (mm)	N (mm)	W1 (mm)	W2 (mm)	W3 (mm)	W3 (mm)	Material
± 2,0	min.	min.	min.	min.	+ 2,0	max.	min.	max.	Polystyrene/ Polyurethane
330,00	1,50	12,80	20,20	60,00	12,40	18,40	11,90	15,40	

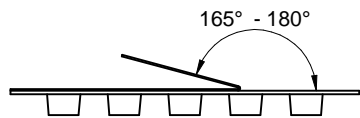

Tape width	12 mm	Pull-of force	0,1 N - 1,3 N
------------	-------	---------------	---------------



Würth Elektronik eiSos GmbH & Co. KG
 EMC & Inductive Solutions
 Max-Eyth-Str. 1
 74638 Waldenburg
 Germany
 Tel. +49 (0) 79 42 945 - 0
 www.we-online.com
 eiSos@we-online.com

CHECKED PSL	REVISION 002.000	DATE (YYYY-MM-DD) 2019-10-02	GENERAL TOLERANCE DIN ISO 2768-1m	PROJECTION METHOD
DESCRIPTION WCAP-PHGP Aluminum Polymer Capacitors			TECHNICAL REFERENCE PSE2917151M6R3DHCT1HT19	
ORDER CODE 875015119004			STATUS Valid	
SIZE/TYPE 7.3 x 4.3 x 1.9		BUSINESS UNIT eiCap		PAGE 3/8

This electronic component has been designed and developed for usage in general electronic equipment only. This product is not authorized for use in equipment where a higher safety standard and reliability standard is especially required or where a failure of the product is reasonably expected to cause severe personal injury or death, unless the parties have executed an agreement specifically governing such use. Moreover Würth Elektronik eiSos GmbH & Co KG products are neither designed nor intended for use in areas such as military, aerospace, aviation, nuclear control, submarine, transportation (automotive control, train control, ship control), transportation signal, disaster prevention, medical, public information network etc. Würth Elektronik eiSos GmbH & Co KG must be informed about the intent of such usage before the design-in stage. In addition, sufficient reliability evaluation checks for safety must be performed on every electronic component which is used in electrical circuits that require high safety and reliability functions or performance.

Classification Reflow Profile for SMT components:



Classification Reflow Soldering Profile:

Profile Feature		Value
Preheat Temperature Min	$T_{s \text{ min}}$	150 °C
Preheat Temperature Max	$T_{s \text{ max}}$	200 °C
Preheat Time t_s from $T_{s \text{ min}}$ to $T_{s \text{ max}}$	t_s	60 - 120 seconds
Ramp-up Rate (T_L to T_p)		3 °C/ second max.
Liquidous Temperature	T_L	217 °C
Time t_L maintained above T_L	t_L	60 - 150 seconds
Peak package body temperature	T_p	see table
Time within 5°C of actual peak temperature	t_p	20 - 30 seconds
Ramp-down Rate (T_L to T_p)		6 °C/ second max.
Time 25°C to peak temperature		8 minutes max.

refer to IPC/ JEDEC J-STD-020E

Package Classification Reflow Temperature:

Properties	Volume mm ³ <350	Volume mm ³ 350-2000	Volume mm ³ >2000
PB-Free Assembly Package Thickness < 1.6 mm	260 °C	260 °C	260 °C
PB-Free Assembly Package Thickness 1.6 mm - 2.5 mm	260 °C	250 °C	245 °C
PB-Free Assembly Package Thickness ≥ 2.5 mm	250 °C	245 °C	245 °C

refer to IPC/ JEDEC J-STD-020E

	CHECKED PSL	REVISION 002.000	DATE (YYYY-MM-DD) 2019-10-02	GENERAL TOLERANCE DIN ISO 2768-1m	PROJECTION METHOD
	DESCRIPTION WCAP-PHGP Aluminum Polymer Capacitors			TECHNICAL REFERENCE PSE2917151M6R3DHCT1HT19	
	Würth Elektronik eiSos GmbH & Co. KG EMC & Inductive Solutions Max-Eyth-Str. 1 74638 Waldenburg Germany Tel. +49 (0) 79 42 945 - 0 www.we-online.com eiSos@we-online.com			ORDER CODE 875015119004	
	SIZE/TYPE 7.3 x 4.3 x 1.9	BUSINESS UNIT eiCap	STATUS Valid	PAGE 4/8	

This electronic component has been designed and developed for usage in general electronic equipment only. This product is not authorized for use in equipment where a higher safety standard and reliability standard is especially required or where a failure of the product is reasonably expected to cause severe personal injury or death, unless the parties have executed an agreement specifically governing such use. Moreover Würth Elektronik eiSos GmbH & Co KG products are neither designed nor intended for use in areas such as military, aerospace, aviation, nuclear control, submarine, transportation (automotive control, train control, ship control), transportation signal, disaster prevention, medical, public information network etc. Würth Elektronik eiSos GmbH & Co KG must be informed about the intent of such usage before the design-in stage. In addition, sufficient reliability evaluation checks for safety must be performed on every electronic component which is used in electrical circuits that require high safety and reliability functions or performance.

Cautions and Warnings:

The following conditions apply to all goods within the product series of Aluminium Polymer SMT H-Chip Capacitors of Würth Elektronik eiSos GmbH & Co. KG:

General:

- This electronic component is designed and manufactured for use in general electronic equipment.
- Würth Elektronik must be asked for a written approval (following the certain PPAP level procedure) before incorporating the components into any equipment in the field such as military, aerospace, aviation, nuclear control, submarine, transportation (automotive control, train control, ship control), transportation signal, disaster prevention, medical, public information network etc. where higher safety and reliability are especially required and/or if there is the possibility of direct damage or human injury.
- Electronic components that will be used in safety-critical or high-reliability applications, should be pre-evaluated by the customer.
- Direct mechanical impact to the product shall be prevented as material of the body, pins or termination could flake or in the worst case it could break.
- Avoid any water or heavy dust on capacitors surface, which may cause electrical leakage, damage, overheating or corrosion.
- Würth Elektronik products are qualified according to international standards, which are listed in each product reliability report. Würth Elektronik does not warrant any customer qualified product characteristic, beyond Würth Elektronik specifications, for its validity and sustainability over time.
- The responsibility for the applicability of the customer specific products and use in a particular customer design is always within the authority of the customer. All technical specifications for standard products also apply to customer specific products.
- The component is designed and manufactured to be used within the datasheet specified values. If the usage and operation conditions specified in the datasheet are not met, the wire insulation may be damaged or dissolved.
- Do not drop or impact the components, the component may be damaged.
- The capacitance tolerance as specified within the datasheet is only valid on the date of delivery and according specified measurement criteria.

Product specific:

Storage conditions:

- A storage of Würth Elektronik products for longer than 24 months is not recommended. Within other effects, the terminals may suffer degradation, resulting in bad solderability. Therefore, all products shall be used within the period of 12 months based on the day of shipment.
- Do not expose the components into direct sunlight.
- The storage conditions for this capacitor is recommended to be 5 °C up to 30 °C and less than 70 % rel. humidity.
- The maximum storage time after opening the package are 7 days.
- The environment in which the capacitors are operated and stored has to have atmospheric characteristics and must be free of dew condensation and toxic gases (e.g. chlorine, ammonia, sulfur, hydrogen sulphide and hydrogen sulfate).

- Do not expose the capacitor to environments with hazardous gas, ozone, ultraviolet rays or any kind of radiation. Avoid any contact of the capacitor with direct sunshine, saltwater, spray of water or types of oil during storage.
- If a capacitor is stored for a long time without applying voltage or storage conditions of 30 °C or above and more than 70 % relative humidity, the leakage current may increase.
- The leakage current will return to normal level when applying the rated voltage to the capacitor before use. If the capacitor was stored for more than 24 months, it is recommended to apply DC working voltage to the capacitor for 30 minutes through a 1 kΩ protective series resistor.

Polarity:

An aluminum polymer capacitor has a polarity. In operation, this polarity needs to be considered and adhered. Reverse voltage can damage or destroy an aluminum polymer capacitor. This can finally lead to a malfunction. If the polarity in a circuit will be switched or possibly can be reversed, the usage of a non-polar capacitor shall be applied. The polarity of an H-Chip Polymer Capacitor is marked as follows: on the top of the component, the positive terminal is marked with a black bar.

Overvoltage:

Avoid any overvoltage and do not apply a continuous overvoltage. If an overvoltage is applied to the capacitor, the leakage current can increase drastically. The applied working voltage is not allowed to exceed the rated working voltage of the specific capacitor.

Operating temperature:



The capacitor shall not be operated above the operating temperature, which is stated in the datasheet of the specific capacitor. The achievable lifetime of the capacitor is correlating to the applied temperature. In order to achieve the maximum lifetime, the capacitor should be operated at the lowest possible temperature conditions within the application.

Ripple current:

- The applied ripple current shall not exceed the specified maximum ripple current of the capacitor. If a higher ripple current as permitted is applied, it can cause excessive heat generation and higher temperature inside the capacitor. This happens due to pole change effects. This can result in damage or lifetime shortage of the capacitor and may cause deterioration. Please see electrical specification within this datasheet for maximum allowed ripple current.

Charge and discharge:

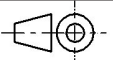
Frequent and quick charge / discharge cycles may generate heat inside the capacitor. In worst case, this can cause a decrease of capacitance, an increase of leakage current or breakdown. Applications with rapid charge and discharge cycles should be avoided. For assistance with your application, please consult our technical support.

	CHECKED	REVISION	DATE (YYYY-MM-DD)	GENERAL TOLERANCE	PROJECTION METHOD	
	PSL	002.000	2019-10-02	DIN ISO 2768-1m		
	WCAP-PHGP Aluminum Polymer Capacitors				TECHNICAL REFERENCE PSE2917151M6R3DHCT1HT19	
					ORDER CODE 875015119004	
Würth Elektronik eiSos GmbH & Co. KG EMC & Inductive Solutions Max-Eyth-Str. 1 74638 Waldenburg Germany Tel. +49 (0) 79 42 945 - 0 www.we-online.com eiSos@we-online.com			SIZE/TYPE	BUSINESS UNIT	STATUS	PAGE
			7.3 x 4.3 x 1.9	eiCap	Valid	5/8

Soldering:

- The solder profile must comply with the technical product specifications. All other profiles will void the warranty.
- All other soldering methods are at the customer's own risk.
- Strong forces which may affect the coplanarity of the component's electrical connection with the PCB (i.e. pins), can damage the part, resulting in void of the warranty.
- Customer needs to ensure that the applied solder paste, the paste thickness and solder conditions are enough to guarantee a sufficient solder result according to the relevant criteria of IPC-A-610.
- Excessive amount of solder may lead to higher tensile force and chip cracking. Insufficient amount of solder may detach the capacitor due to defective contacts.
- Do not use excessive nor insufficient flux.
- Provide enough washing when water-soluble flux is used.

Cleaning and washing:

Do not wash the assembled capacitors with the following cleaning agents:

- Petroleum system solvents: may cause degeneration of the rubber seal material.
- Alkali system solvents: may cause corrosion and dissolve of the aluminum case.
- Halogenated solvents: may cause corrosion and failure of the capacitor.
- Acetone: component marking may be erased.
- Xylene: may cause deterioration of the rubber seal material.

Verify the following points when washing is applied to capacitors:

- Please monitor conductivity, pH-value, specific gravity and the water content of cleaning agents. Contamination adversely affects these characteristics.
- After soldering, the component should be cleaned according to the following conditions: Temperature: less than 60°C; Time: within 5 minutes
- In addition, please make sure to dry thoroughly afterwards. It's better to apply 100°C for 20 minutes.
- Please check the solvents carefully before using them.
- Be sure to not expose the capacitors under solvent rich conditions or keep capacitors inside a closed container.
- Capacitors can be characteristically and catastrophically damaged by halogen ions, particularly by chlorine ions. The degree of the damage mainly depends upon the characteristics of the electrolyte and rubber seal material. When halogen ions come into contact with the inside of the capacitors, the foil may corrode, when a voltage is applied. This corrosion causes an extremely high leakage current, which results in venting and an open circuit defect.

All other cleaning processes and cleaning agents are not approved by Würth Elektronik. All cleaning methods need to be tested and validated by the customer.

Adhesives and coating materials:

The usage of any adhesive or coating material, which contains halogenated solvents, is not allowed. Before applying adhesives or coating materials, make sure that the following points are fulfilled:

- Take care that the surface and capacitor is dry and clean before applying adhesive or coating, to avoid any contamination with flux residues or cleaning solvents.
- Assure that no flux residue or spot is left between the capacitor and the PCB.
- Do not fully cover the entire surface with adhesive, coating or molding materials.
- Follow the specified heating and curing instructions given by supplier of the used adhesive or coating material. Avoid excessive pressure or heat on the capacitor by applying coating or adhesive.
- Take care that hardening of adhesive, coating material was correctly done, so that no solvents do remain.

Operation and usage of the capacitor:

In operation and usage, take care about the following points. Do not use the capacitor within the following environmental conditions:

- Environment with high mechanical stress / shocks or vibration (please see this specific datasheet for permitted limits).
- Environment with high amount of damp condensation, water or types of oil.
- Direct sunlight, ozone, any kind of radiation or ultraviolet rays.
- Toxic gases (e.g. ammonium, chlorine and compounds, bromine and compounds, hydrogen sulfide, sulfuric acid).

User should never touch the terminals of the capacitor directly. Avoid short circuit between terminals with any kind of conductive material (e.g. metal, fluid, acid, alkaline solution).

Maintenance:



For industrial applications, it is recommended to perform periodic inspections. Power supplies shall be turned off before inspection to discharge the capacitor. Check the following points in case of an inspection:

- Visual inspection of the capacitor to see, if there is a good appearance of the capacitors.
- Measurement of electrical characteristics of the capacitor (according to datasheet, especially leakage current, capacitance and dissipation factor).

In case of deviation or failure according to the specified characteristics, take care to start appropriate actions (e.g. replacement of capacitor).

Emergency case:

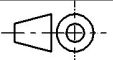
If the product is overheated, the resin case temperature will be high and the product may burn. If this happens, please turn off the device's main power immediately and keep it away.

	CHECKED	REVISION	DATE (YYYY-MM-DD)	GENERAL TOLERANCE	PROJECTION METHOD	
	PSL	002.000	2019-10-02	DIN ISO 2768-1m		
	DESCRIPTION				TECHNICAL REFERENCE	
	WCAP-PHGP Aluminum Polymer Capacitors				PSE2917151M6R3DHCT1HT19	
Würth Elektronik eiSos GmbH & Co. KG EMC & Inductive Solutions Max-Eyth-Str. 1 74638 Waldenburg Germany Tel. +49 (0) 79 42 945 - 0 www.we-online.com eiSos@we-online.com				ORDER CODE		
				875015119004		
SIZE/TYPE			BUSINESS UNIT	STATUS	PAGE	
7.3 x 4.3 x 1.9			eiCap	Valid	6/8	

Additional requirements for aluminum polymer capacitors:

Circuits and designs where the usage of Stack Type Aluminum Polymer Capacitors is prohibited are:



- High-impedance circuits
- Coupling circuits
- Time constant circuits

Due to thermal stress, the leakage of aluminum polymer capacitor can vary within the above stated applications. If you want to use two or more aluminum polymer capacitors in series connection for circuit designs, which are significantly affected by leakage current, please contact our technical staff before usage.

Disposal:

Please contact your local responsible organization for proper disposal of capacitor. In addition, take care to be compliant with your local governmental law and restrictions. In case of disposal, please treat the capacitors as industrial waste.

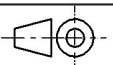
These cautions and warnings comply with the state of the scientific and technical knowledge and are believed to be accurate and reliable. However, no responsibility is assumed for inaccuracies or incompleteness.

	CHECKED PSL	REVISION 002.000	DATE (YYYY-MM-DD) 2019-10-02	GENERAL TOLERANCE DIN ISO 2768-1m	PROJECTION METHOD 
	DESCRIPTION WCAP-PHGP Aluminum Polymer Capacitors				TECHNICAL REFERENCE PSE2917151M6R3DHCT1HT19
	Würth Elektronik eiSos GmbH & Co. KG EMC & Inductive Solutions Max-Eyth-Str. 1 74638 Waldenburg Germany Tel. +49 (0) 79 42 945 - 0 www.we-online.com eiSos@we-online.com				ORDER CODE 875015119004
	SIZE/TYPE 7.3 x 4.3 x 1.9	BUSINESS UNIT eiCap	STATUS Valid	PAGE 7/8	

Important Notes

The following conditions apply to all goods within the product range of Würth Elektronik eiSos GmbH & Co. KG:

1. General Customer Responsibility

Some goods within the product range of Würth Elektronik eiSos GmbH & Co. KG contain statements regarding general suitability for certain application areas. These statements about suitability are based on our knowledge and experience of typical requirements concerning the areas, serve as general guidance and cannot be estimated as binding statements about the suitability for a customer application. The responsibility for the applicability and use in a particular customer design is always solely within the authority of the customer. Due to this fact it is up to the customer to evaluate, where appropriate to investigate and decide whether the device with the specific product characteristics described in the product specification is valid and suitable for the respective customer application or not.

2. Customer Responsibility related to Specific, in particular Safety-Relevant Applications

It has to be clearly pointed out that the possibility of a malfunction of electronic components or failure before the end of the usual lifetime cannot be completely eliminated in the current state of the art, even if the products are operated within the range of the specifications. In certain customer applications requiring a very high level of safety and especially in customer applications in which the malfunction or failure of an electronic component could endanger human life or health it must be ensured by most advanced technological aid of suitable design of the customer application that no injury or damage is caused to third parties in the event of malfunction or failure of an electronic component. Therefore, customer is cautioned to verify that data sheets are current before placing orders. The current data sheets can be downloaded at www.we-online.com.

3. Best Care and Attention

Any product-specific notes, cautions and warnings must be strictly observed. Any disregard will result in the loss of warranty.

4. Customer Support for Product Specifications

Some products within the product range may contain substances which are subject to restrictions in certain jurisdictions in order to serve specific technical requirements. Necessary information is available on request. In this case the field sales engineer or the internal sales person in charge should be contacted who will be happy to support in this matter.

5. Product R&D

Due to constant product improvement product specifications may change from time to time. As a standard reporting procedure of the Product Change Notification (PCN) according to the JEDEC-Standard inform about minor and major changes. In case of further queries regarding the PCN, the field sales engineer or the internal sales person in charge should be contacted. The basic responsibility of the customer as per Section 1 and 2 remains unaffected.

6. Product Life Cycle



Due to technical progress and economical evaluation we also reserve the right to discontinue production and delivery of products. As a standard reporting procedure of the Product Termination Notification (PTN) according to the JEDEC-Standard we will inform at an early stage about inevitable product discontinuance. According to this we cannot guarantee that all products within our product range will always be available. Therefore it needs to be verified with the field sales engineer or the internal sales person in charge about the current product availability expectancy before or when the product for application design-in disposal is considered. The approach named above does not apply in the case of individual agreements deviating from the foregoing for customer-specific products.

7. Property Rights

All the rights for contractual products produced by Würth Elektronik eiSos GmbH & Co. KG on the basis of ideas, development contracts as well as models or templates that are subject to copyright, patent or commercial protection supplied to the customer will remain with Würth Elektronik eiSos GmbH & Co. KG. Würth Elektronik eiSos GmbH & Co. KG does not warrant or represent that any license, either expressed or implied, is granted under any patent right, copyright, mask work right, or other intellectual property right relating to any combination, application, or process in which Würth Elektronik eiSos GmbH & Co. KG components or services are used.

8. General Terms and Conditions

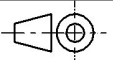
Unless otherwise agreed in individual contracts, all orders are subject to the current version of the "General Terms and Conditions of Würth Elektronik eiSos Group", last version available at www.we-online.com.

	CHECKED PSL	REVISION 002.000	DATE (YYYY-MM-DD) 2019-10-02	GENERAL TOLERANCE DIN ISO 2768-1m	PROJECTION METHOD 
	DESCRIPTION WCAP-PHGP Aluminum Polymer Capacitors				TECHNICAL REFERENCE PSE2917151M6R3DHCT1HT19
	Würth Elektronik eiSos GmbH & Co. KG EMC & Inductive Solutions Max-Eyth-Str. 1 74638 Waldenburg Germany Tel. +49 (0) 79 42 945 - 0 www.we-online.com eiSos@we-online.com			ORDER CODE 875015119004	
	SIZE/TYPE 7.3 x 4.3 x 1.9	BUSINESS UNIT eiCap	STATUS Valid	PAGE 8/8	