

DO NOT SCALE FROM THIS PRINT

CLP-1XX-XX-XXX-D-XX-XX-XX

NOTES:

1. $\text{\textcircled{C}}$ REPRESENTS A CRITICAL DIMENSION.
2. MINIMUM PUSHOUT FORCE: .5LB (8 OZ).
3. ONE POSITION WILL BE LOST FOR EVERY CUT MADE ON A SOCKET STRIP.
4. TUBE PACKAGE POSITIONS 5-50 ONLY. POSITIONS 2-4 ARE TO BE PLACED IN ANTISTATIC BUBBLE BAGS P/N ASBBLT4X5.5.
5. SHEAR TAILS TO DIMENSIONS SHOWN.
6. NOTE DELETED.
7. TAIL SIDE ENDWALL AFTER CUTTING: .0160[0.406]±.0025[0.064].
8. VOID CORES MAY NOT BE PRESENT.
9. HAND FILL USE C-106-01-XX.
CAN'T HAND FILL -STL & -LTL-PLATING.
AUTOMATION USE C-106-22-XX. C-106-02-XX CAN BE SUBBED FOR C-106-22-XX.
FOR -LTL AND -STL PLATING USE SUB-C-106-X2-XTL PINS
10. MAX CUT FLASH: .010[0.25] X .020[0.51] (HEIGHT X WIDTH) WITH NO FLASH ALLOWED IN HOLES OR EXTENDING BELOW LEADS.
11. MAX BURR: .005[.13].
12. -PA OPTION MUST SHIP IN -TR, -FR OR TRAYS. LEAVE PACKAGING OPTION BLANK FOR TRAYS.
13. DOES NOT APPLY TO -BE END OPTION.
14. NOTE DELETED.
15. NOTE DELETED.
16. TUBES ARE STANDARD PACKAGING.
17. ORDERS WILL BE PACKAGED ACCORDING TO THE SAMTEC PACKAGING EFFICIENCY STANDARDS (SPES) FOUND ON WWW.SAMTEC.COM
18. ATTACH LABEL -4x2 TO EACH REEL.

No OF POSITIONS PER ROW

-02 THRU -50

LEAD STYLE SPEC

-02: SURFACE MOUNT
(USE C-106-X2-XXX OR SUB-C-106-X2-XXX)
(SEE NOTE 9)

PACKAGING OPTION

BLANK: TUBES (SEE NOTES 16 & 17)
-TR: TAPE AND REEL (SEE NOTE 17 & 18)
-FR: FULL REEL QTY. TAPE & REEL (SEE NOTE 17 & 18)

PICK & PLACE OPTION

-P: PICK & PLACE PAD (USE LMP-01)
(AVAILABLE ON POSITON -05 THRU -50 ONLY)
(NOT AVAILABLE WITH -PA OR -K OPTIONS)
(SEE FIG 3, SHT 2)
-PA: PICK & PLACE PAD WITH ALIGNMENT PINS
(NOT AVAILABLE WITH -P, -A, OR -K OPTIONS)
(SEE SHT 2, TABLE 3)(SEE NOTE 12)
-K: POLYIMIDE FILM PAD (AVAILABLE ON -03 THRU -50 POSITIONS. USE K-DOT-.157-.250-.005) (AVAILABLE ON -02 POSITIONS. USE K-DOT-.118-.219-.005) (SEE FIG 5, SHT 2)(NOT AVAILABLE WITH -P OR -PA OPTIONS)

OPTION

-A: ALIGNMENT PIN (USE CLP-XX-D-XX)
(NOT AVAILABLE WITH -PA OPTION)
(SEE FIG 2, SHT 2)
-BE: BOTTOM ENTRY ONLY (USE CLP-XX-DBE-XX)

BODY SPEC

-D: DOUBLE ROW
(USE CLP-XX-D)

PLATING SPEC

-F: 3µ" FLASH SELECTIVE GOLD IN CONTACT AREA
MATTE TIN ON TAIL
-L: 10µ" LIGHT SELECTIVE GOLD IN CONTACT AREA
MATTE TIN ON TAIL
-S: 30µ" SELECTIVE GOLD IN CONTACT AREA
MATTE TIN ON TAIL
-G: 10µ" GOLD IN CONTACT AREA
3µ" ON TAIL
-H: 30µ" HEAVY GOLD IN CONTACT AREA
3µ" ON TAIL
-LM: 10µ" LIGHT SELECTIVE GOLD IN CONTACT AREA
MATTE TIN ON TAIL
-FM: 3µ" FLASH SELECTIVE GOLD IN CONTACT AREA
MATTE TIN ON TAIL
-SM: 30µ" SELECTIVE GOLD IN CONTACT AREA
MATTE TIN ON TAIL
-LTL: 10µ" LIGHT SELECTIVE GOLD IN CONTACT AREA
TIN/LEAD (90/10+/-5%) TAIL (SEE NOTE 9)
-STL: 30µ" SELECTIVE GOLD IN CONTACT AREA
TIN/LEAD (90/10+/-5%) TAIL (SEE NOTE 9)

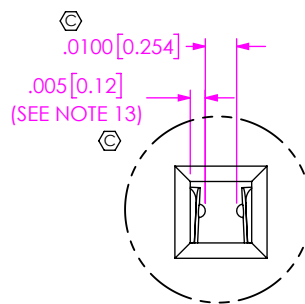

DETAIL 'D'
SCALE 16:1

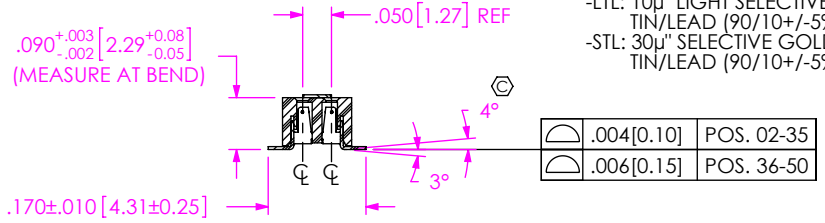
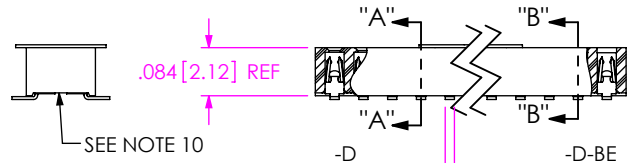
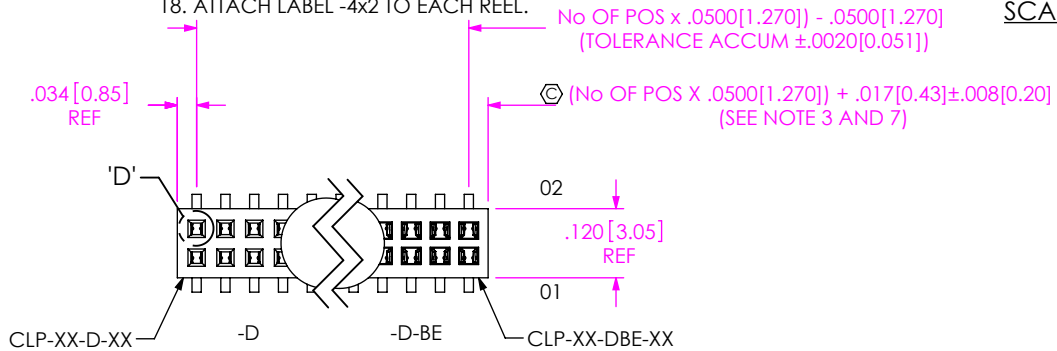

SECTION "A"-"A"
(-D BODY: CLP-XX-D-XX)

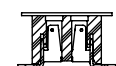

SECTION "B"-"B"
(-D-BE BODY: CLP-XX-DBE-XX)
(DIFFERENT AS SHOWN,
OTHERWISE SAME AS -D BODY)

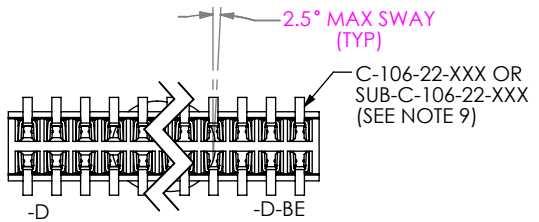
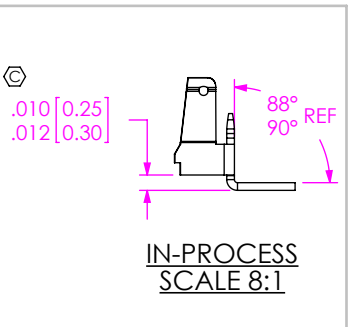

FIG 1

UNLESS OTHERWISE SPECIFIED, DIMENSIONS ARE IN INCHES.
TOLERANCES ARE:
DECIMALS ANGLES
.XX: ±.01 [.3] 2°
.XXX: ±.005 [.13]
.XXXX: ±.0020 [.051]

PROPRIETARY NOTE
THIS DOCUMENT CONTAINS CONFIDENTIAL AND PROPRIETARY INFORMATION AND ALL DESIGN, MANUFACTURING, REPRODUCTION, USE, PATENT RIGHTS AND SALES RIGHTS ARE EXPRESSLY RESERVED BY SAMTEC, INC. THIS DOCUMENT SHALL NOT BE DISCLOSED, IN WHOLE OR PART, TO ANY UNAUTHORIZED PERSON OR ENTITY NOR REPRODUCED, TRANSFERRED OR INCORPORATED IN ANY OTHER PROJECT IN ANY MANNER WITHOUT THE EXPRESS WRITTEN CONSENT OF SAMTEC, INC.



520 PARK EAST BLVD, NEW ALBANY, IN 47150
PHONE: 812-944-6733 FAX: 812-948-5047
e-Mail: info@SAMTEC.com code 53322

MATERIAL: DO NOT SCALE DRAWING SHEET SCALE: 3:1

DESCRIPTION: LOW PROFILE .050 x .050 DOUBLE ROW ASM

INSULATOR: LCP, UL 94 VO, COLOR: BLACK
CONTACT: PHOS BRONZE

DWG. NO. CLP-1XX-XX-XXX-D-XX-XX-XX

AVAILABLE ON POSITIONS 05 THRU 50 ONLY
 NOTE: "N" = USED MEASURED DIMENSION (REF)
 "Q" = $[(\text{"N"} - .250[6.35])/2] \pm .020[0.51]$

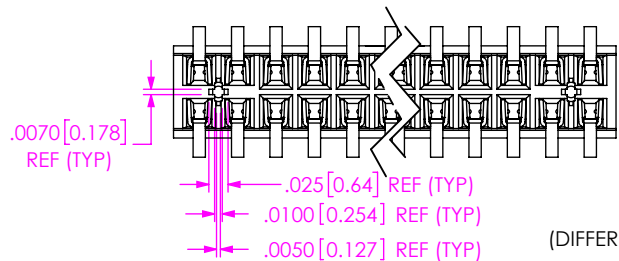
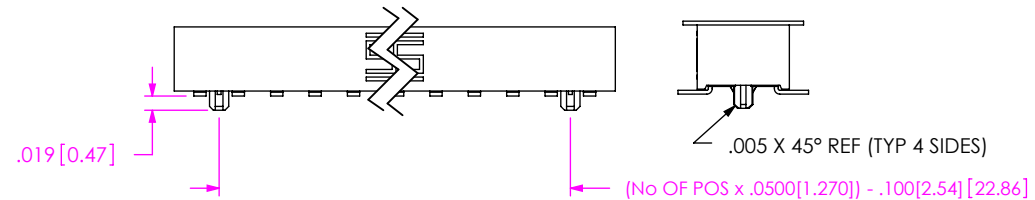

FIG 2
 -A: ALIGNMENT PIN
 (3 POSITION MINIMUM)
 (NOT AVAILABLE WITH -PA OPTION)
 (DIFFERENT AS SHOWN, OTHERWISE SAME AS FIG 1)

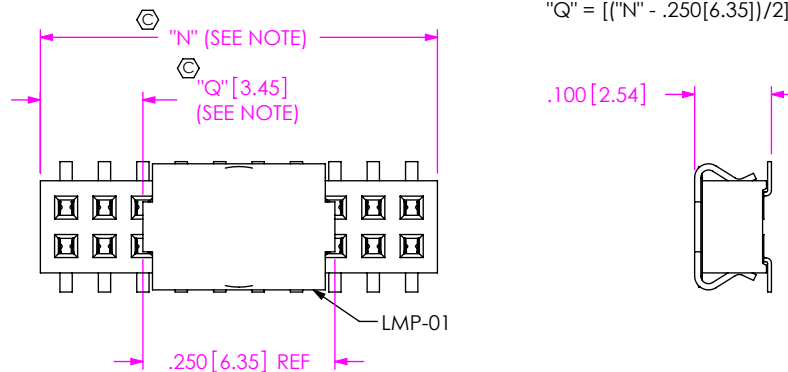

FIG 3
 -P: PICK AND PLACE PAD
 (NOT AVAILABLE WITH -PA OR -K OPTIONS)

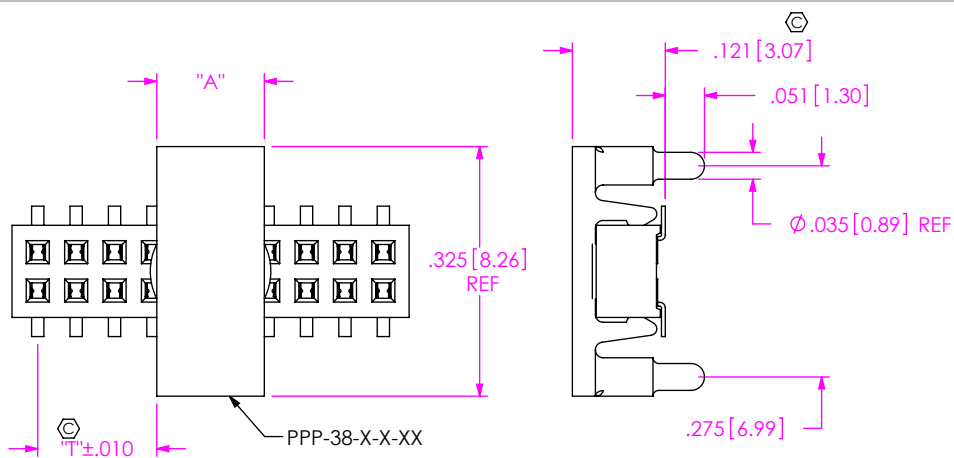

FIG 4
 -PA: PICK & PLACE PAD WITH ALIGNMENT PINS
 (NOT AVAILABLE WITH -P, -A OR -K OPTIONS)

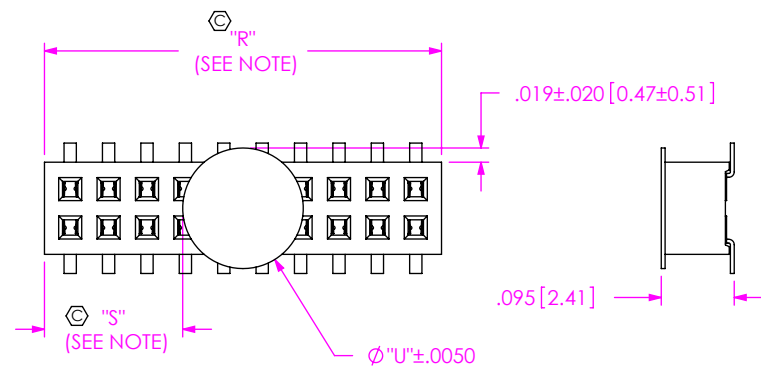

FIG 5
 -K: POLYIMIDE FILM PAD
 (AVAILABLE ON POSITION 05 THRU 50 ONLY)
 (NOT AVAILABLE WITH -P OR -PA OPTIONS)

NOTE: "R" = USED MEASURED DIMENSION (REF)
 "S" ON -03 THRU -50 POS = $\{(\text{"R"} - .1575[4.000])/2\} \pm .020[0.51]$
 "S" ON -02 POS = $\{(\text{"R"} - .1180[2.997])/2\} \pm .020[0.51]$
 "U" ON -03 THRU -50 POS = .1575 [4.000]
 "U" ON -02 POS = .118 [2.997]

TABLE 3				
POS/ROW	PIN COUNT	PAD	"A"	"T"
4-15	ODD	PPP-38-O-4-15	.140 [3.56] REF	$\{((\text{No OF POS} - 1)/2) \times .050[1.27]\} - .070[1.78]$
	EVEN	PPP-38-E-4-15		
16-50	ODD	PPP-38-O-16-50	.280 [7.11] REF	$\{((\text{No OF POS} - 1)/2) \times .050[1.27]\} - .140[3.56]$
	EVEN	PPP-38-E-16-50		

PROPRIETARY NOTE
 THIS DOCUMENT CONTAINS CONFIDENTIAL AND PROPRIETARY INFORMATION AND ALL DESIGN, MANUFACTURING, REPRODUCTION, USE, PATENT RIGHTS AND SALES RIGHTS ARE EXPRESSLY RESERVED BY SAMTEC, INC. THIS DOCUMENT SHALL NOT BE DISCLOSED, IN WHOLE OR PART, TO ANY UNAUTHORIZED PERSON OR ENTITY NOR REPRODUCED, TRANSFERRED OR INCORPORATED IN ANY OTHER PROJECT IN ANY MANNER WITHOUT THE EXPRESS WRITTEN CONSENT OF SAMTEC, INC.

DO NOT SCALE DRAWING
 SHEET SCALE: 4:1

520 PARK EAST BLVD, NEW ALBANY, IN 47150
 PHONE: 812-944-6733 FAX: 812-948-5047
 e-Mail info@SAMTEC.com code 55322

DESCRIPTION:
 LOW PROFILE .050 x .050 DOUBLE ROW ASM
 DWG. NO.
CLP-1XX-XX-XXX-D-XX-XX-XX
 BY: PURVIS 01/31/1994 SHEET 2 OF 3

PACKAGING
(SEE NOTE 4, SHEET 1)

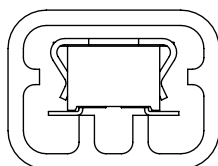

PT-CLX-002-D

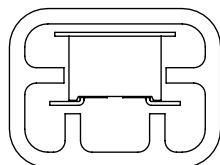

PT-CLX-001-D

TABLE 2		
OPTION	TUBE	PLUG
NONE, -A	PT-CLX001-D	TP-33
-P, -A-P	PT-CLX002-D	TP-33
-A-K, -K	PT-CLX001-D	TP-33

PROPRIETARY NOTE
 THIS DOCUMENT CONTAINS CONFIDENTIAL AND PROPRIETARY INFORMATION AND ALL DESIGN, MANUFACTURING, REPRODUCTION, USE, PATENT RIGHTS AND SALES RIGHTS ARE EXPRESSLY RESERVED BY SAMTEC, INC. THIS DOCUMENT SHALL NOT BE DISCLOSED, IN WHOLE OR PART, TO ANY UNAUTHORIZED PERSON OR ENTITY NOR REPRODUCED, TRANSFERRED OR INCORPORATED IN ANY OTHER PROJECT IN ANY MANNER WITHOUT THE EXPRESS WRITTEN CONSENT OF SAMTEC, INC.

DO NOT SCALE DRAWING

SHEET SCALE: 4:1



520 PARK EAST BLVD, NEW ALBANY, IN 47150
 PHONE: 812-944-6733 FAX: 812-948-5047
 e-Mail info@SAMTEC.com code 55322

DESCRIPTION:
 LOW PROFILE .050 x .050 DOUBLE ROW ASM

DWG. NO.
CLP-1XX-XX-XXX-D-XX-XX-XX

BY: PURVIS 01/31/1994 SHEET 3 OF 3