

DO NOT SCALE FROM THIS PRINT

POWER OPTION (RIGHT)

- AXX: AC POWER
- DXX: DC POWER (SEE NOTE 5)
- **SXX: SPLIT POWER
- 000: NO POWER (SEE NOTE 3)

ROWS

- 0: NO SIGNAL
- 3: 3 ROWS
- 5: 5 ROWS

SIGNAL POS PER ROW

- 00: NO SIGNAL
- XX: SEE NOTE 4

POWER OPTION (LEFT)

- AXX: AC POWER
- DXX: DC POWER (SEE NOTE 5)
- **SXX: SPLIT POWER
- 000: NO POWER (SEE NOTE 3)

GUIDE POST

- (MUST CHOOSE ONE)
- T: TOP (NOT AVAILABLE WITH -SXX)
- S: SIDE

TAIL

- R1: FOR .062" PCB
- *-R2: FOR .093" PCB
- RP: PRESS FIT (SIGNAL ROWS MUST BE -5)

PLATING SPECIFICATION

- L: 10 μ" SELECTIVE GOLD IN CONTACT AREA, MATTE TIN ON TAIL
- S: 30 μ" SELECTIVE GOLD IN CONTACT AREA, MATTE TIN ON TAIL

(* = NOT TOOLED)
(** = NOT RELEASED)

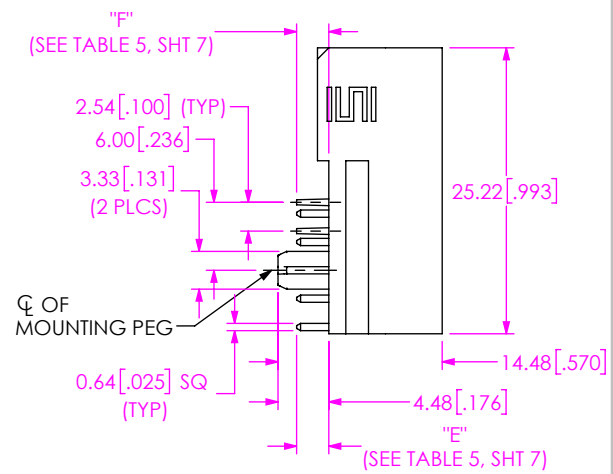
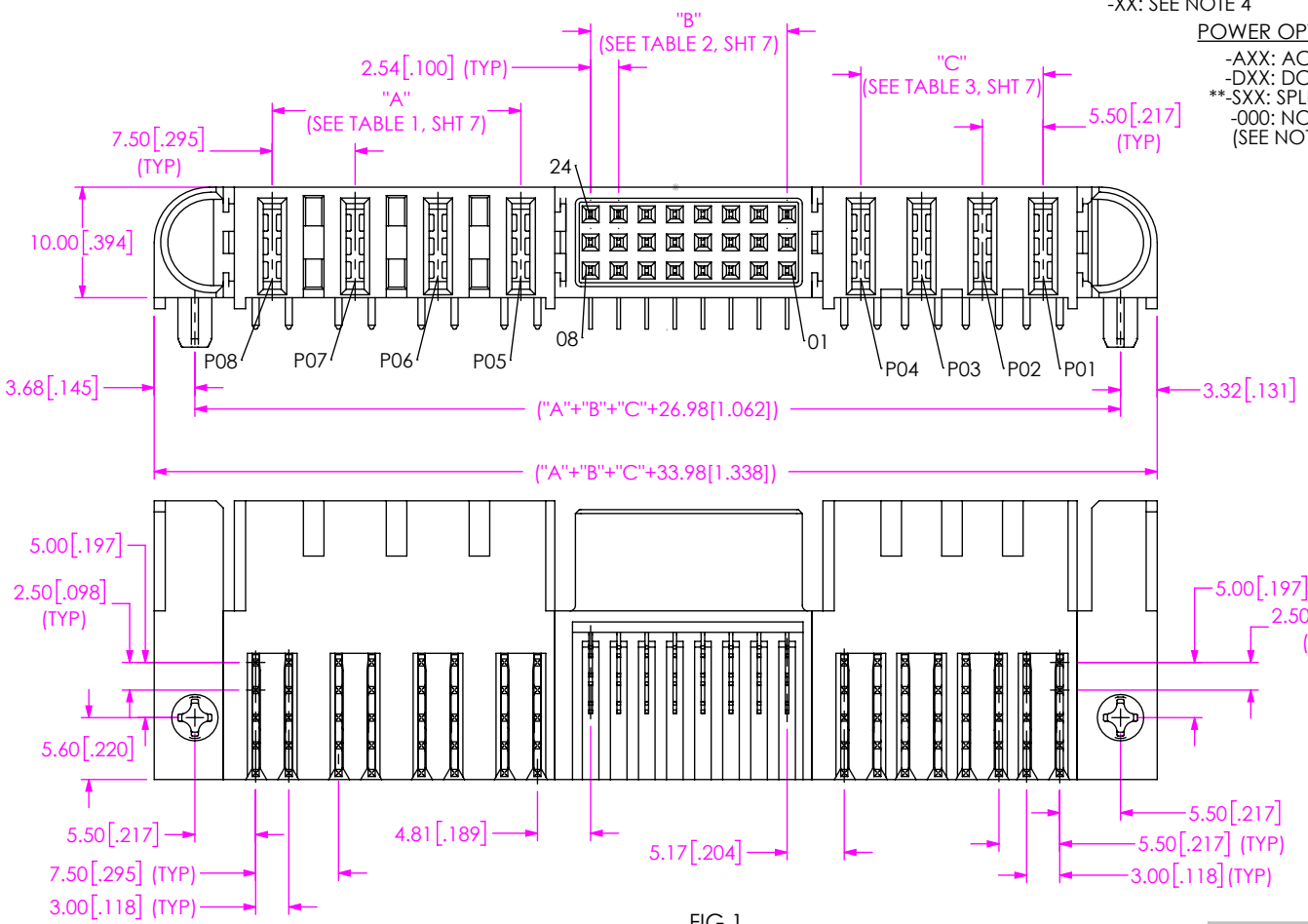
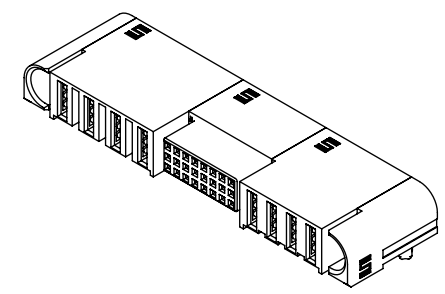

FIG 1
ET60S-D04-3-08-A04-X-R1-S SHOWN

NOTES:

1. SEE PRODUCT SPECIFICATION FOR CONNECTOR PRESS FIT INSTRUCTIONS AND REQUIRED FIXTURES.
2. ASSEMBLIES TO BE PACKAGED IN TRAYS.
3. -AC POWER: *-01, -02, -03, -04, -05, -06;
-DC POWER: *-01, -02, -03, -04, -05, -06, -07, -08, -09, -10.
SPLIT POWER: *-01, *-02, *-03.
(* = NOT TOOLED)
4. -3 ROWS: *-02, *-04, *-06, -08, *-10, *-12.
-5 ROWS: -01, -02, -03, -04, -05, -06, -07, -08.
(* = NOT TOOLED)
5. ORDERS WILL BE PACKAGED ACCORDING TO THE SAMTEC PACKAGING EFFICIENCY STANDARDS (SPES) FOUND ON WWW.SAMTEC.COM.

PROPRIETARY NOTE
THIS DOCUMENT CONTAINS CONFIDENTIAL AND PROPRIETARY INFORMATION AND ALL DESIGN, MANUFACTURING, REPRODUCTION, USE, PATENT RIGHTS AND SALES RIGHTS ARE EXPRESSLY RESERVED BY SAMTEC, INC. THIS DOCUMENT SHALL NOT BE DISCLOSED, IN WHOLE OR PART, TO ANY UNAUTHORIZED PERSON OR ENTITY NOR REPRODUCED, TRANSFERRED OR INCORPORATED IN ANY OTHER PROJECT IN ANY MANNER WITHOUT THE EXPRESS WRITTEN CONSENT OF SAMTEC, INC.

DO NOT SCALE DRAWING
SHEET SCALE: 3:2

MATERIAL:
INSULATOR: LCP, COLOR: BLACK
SIGNAL TERMINAL: COPPER ALLOY
POWER TERMINAL: COPPER ALLOY

samtec
520 PARK EAST BLVD, NEW ALBANY, IN 47150
PHONE: 812-944-6733 FAX: 812-948-5047
e-Mail info@SAMTEC.com code 55322

DESCRIPTION:
ET60 RA POWER/ SIGNAL SOCKET

DWG. NO.
ET60S-XXX-X-XX-XXX-X-RX-X

BY: TOBIN Q 9/4/2023 SHEET 1 OF 10

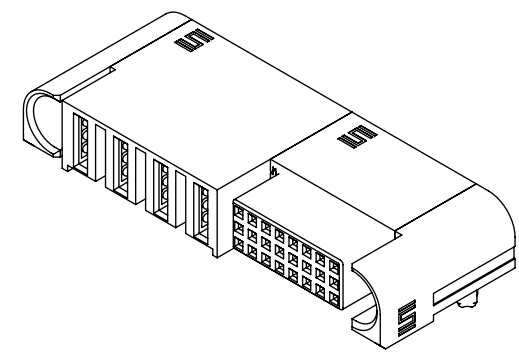
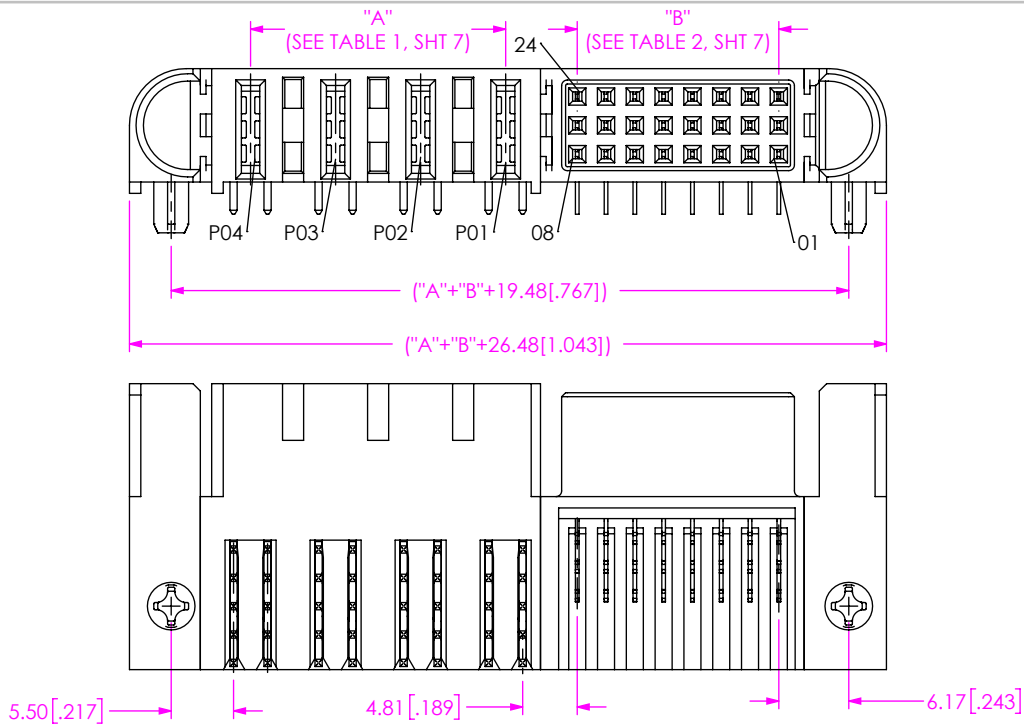

FIG 2
ET60S-000-3-08-A04-X-R1-S SHOWN
(DIFFERENT AS SHOWN, OTHERWISE SAME AS FIG 1)

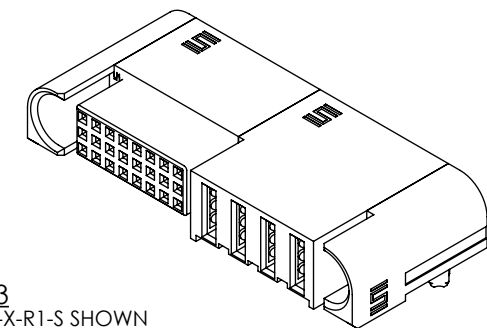
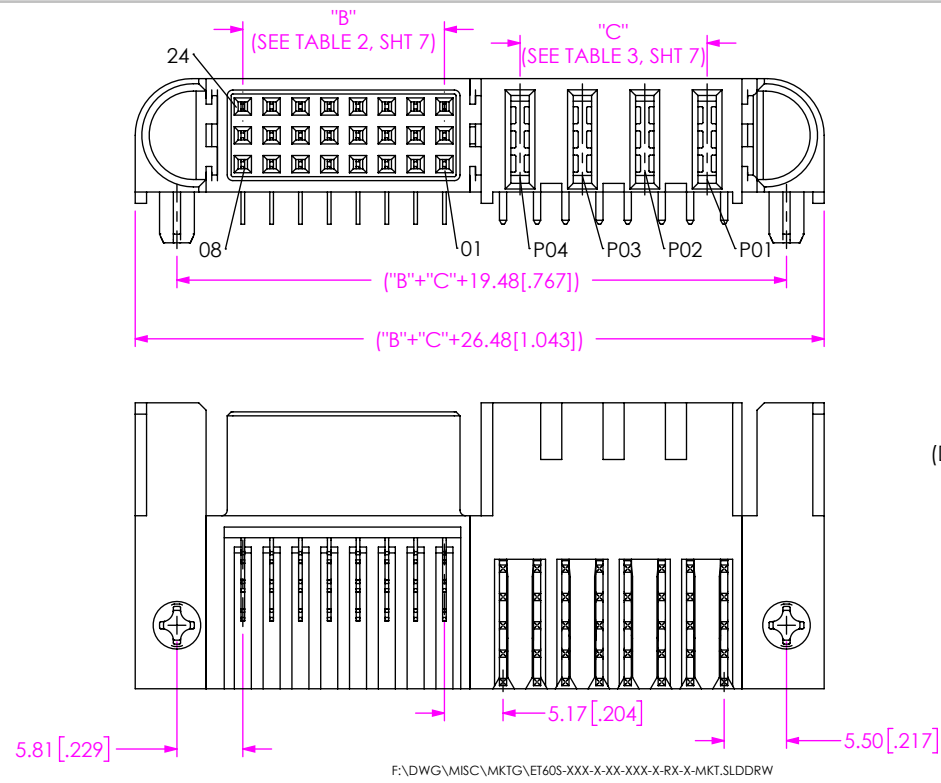

FIG 3
ET60S-D04-3-08-000-X-R1-S SHOWN
(DIFFERENT AS SHOWN, OTHERWISE SAME AS FIG 1)

<p>PROPRIETARY NOTE</p> <p>THIS DOCUMENT CONTAINS CONFIDENTIAL AND PROPRIETARY INFORMATION AND ALL DESIGN, MANUFACTURING, REPRODUCTION, USE, PATENT RIGHTS AND SALES RIGHTS ARE EXPRESSLY RESERVED BY SAMTEC, INC. THIS DOCUMENT SHALL NOT BE DISCLOSED, IN WHOLE OR PART, TO ANY UNAUTHORIZED PERSON OR ENTITY NOR REPRODUCED, TRANSFERRED OR INCORPORATED IN ANY OTHER PROJECT IN ANY MANNER WITHOUT THE EXPRESS WRITTEN CONSENT OF SAMTEC, INC.</p>	<p>520 PARK EAST BLVD., NEW ALBANY, IN 47150 PHONE: 812-944-6733 FAX: 812-948-5047 e-Mail info@SAMTEC.com code 55322</p>	
	<p>DESCRIPTION: ET60 RA POWER/ SIGNAL SOCKET</p>	
	<p>DWG. NO. ET60S-XXX-X-XX-XXX-X-RX-X</p>	<p>BY: TOBIN Q 9/4/2023 SHEET 2 OF 10</p>

SHEET SCALE: 2:1

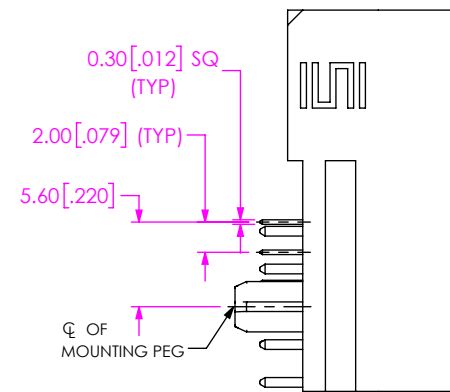
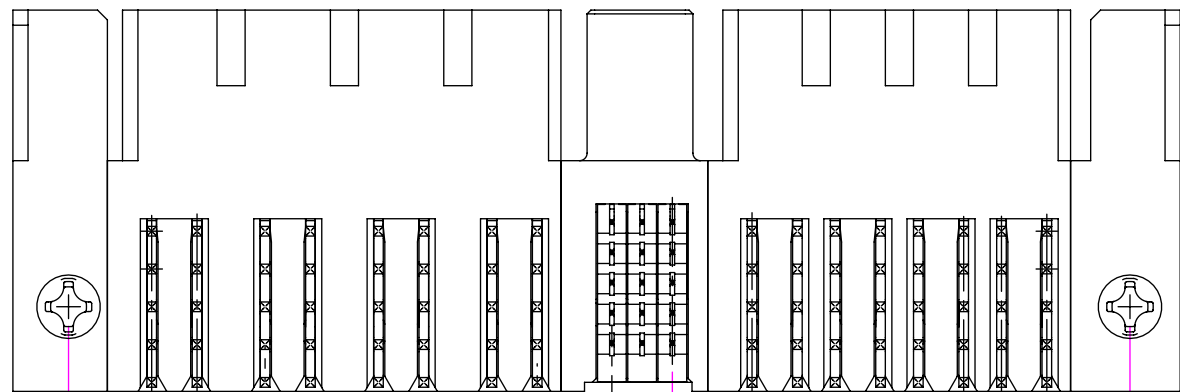
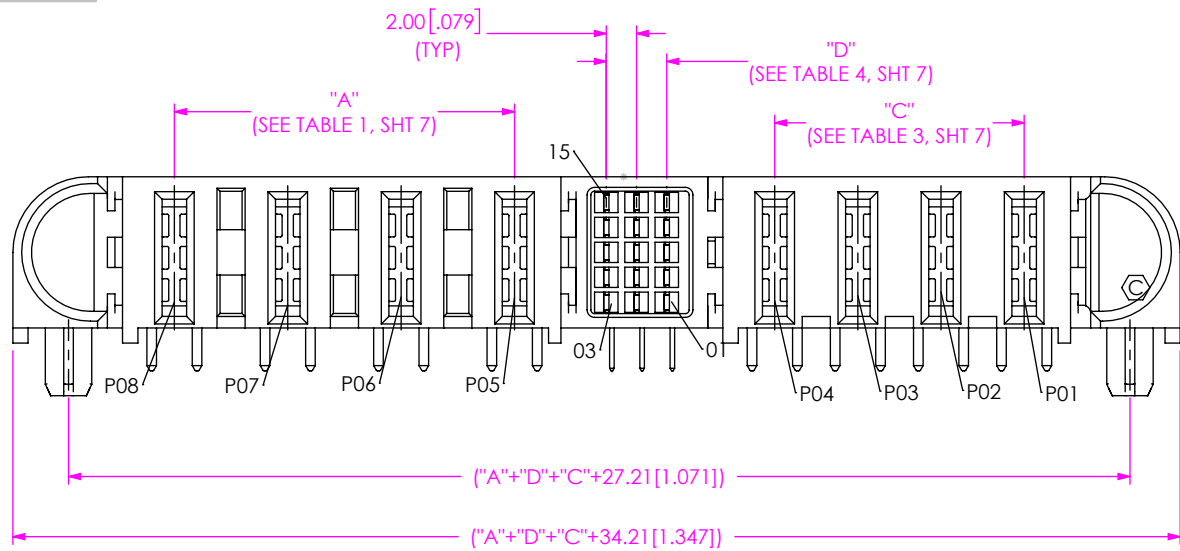
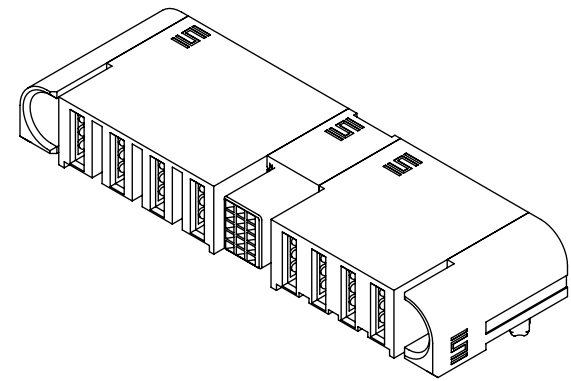

FIG 4
 ET60S-D04-5-03-A04-X-R1-S SHOWN
 (DIFFERENT AS SHOWN, OTHERWISE SAME AS FIG 1)

PROPRIETARY NOTE

THIS DOCUMENT CONTAINS CONFIDENTIAL AND PROPRIETARY INFORMATION AND ALL DESIGN, MANUFACTURING, REPRODUCTION, USE, PATENT RIGHTS AND SALES RIGHTS ARE EXPRESSLY RESERVED BY SAMTEC, INC. THIS DOCUMENT SHALL NOT BE DISCLOSED, IN WHOLE OR PART, TO ANY UNAUTHORIZED PERSON OR ENTITY NOR REPRODUCED, TRANSFERRED OR INCORPORATED IN ANY OTHER PROJECT IN ANY MANNER WITHOUT THE EXPRESS WRITTEN CONSENT OF SAMTEC, INC.



520 PARK EAST BLVD., NEW ALBANY, IN 47150
 PHONE: 812-944-6733 FAX: 812-948-5047
 e-Mail info@SAMTEC.com code 55322

SHEET SCALE: 3:2

DESCRIPTION:
 ET60 RA POWER/ SIGNAL SOCKET

DWG. NO.
 ET60S-XXX-X-XX-XXX-X-RX-X

BY: TOBIN Q 9/4/2023 SHEET 3 OF 10

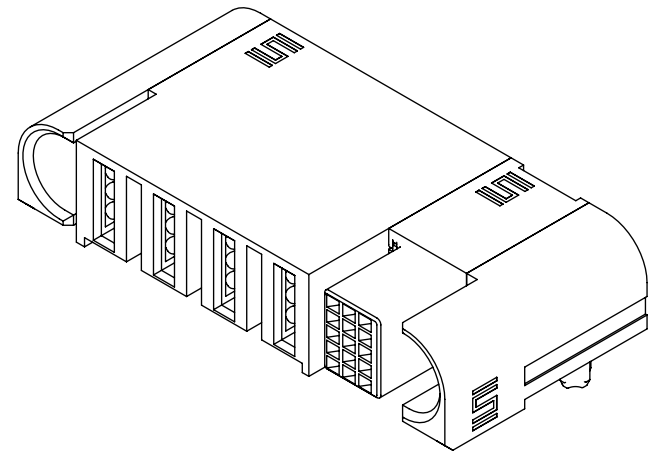
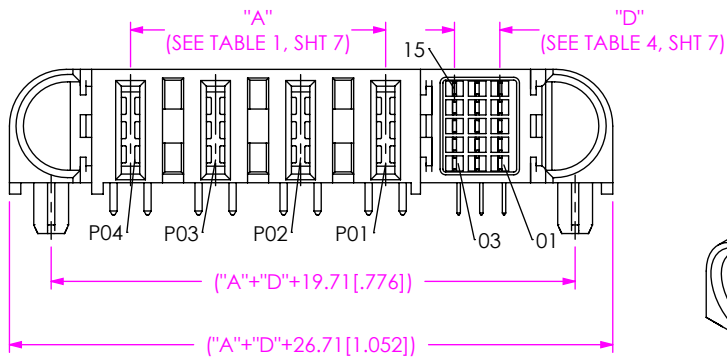

FIG 5
ET60S-000-5-03-A04-X-R1-S SHOWN
(DIFFERENT AS SHOWN, OTHERWISE SAME AS FIG 4)

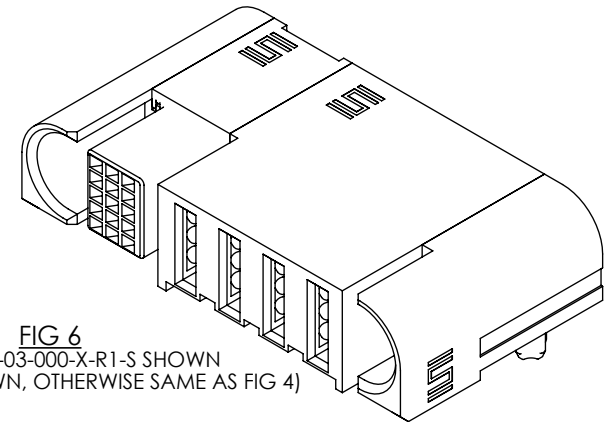
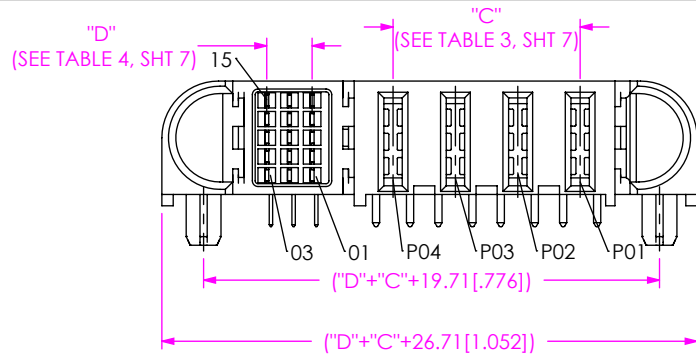
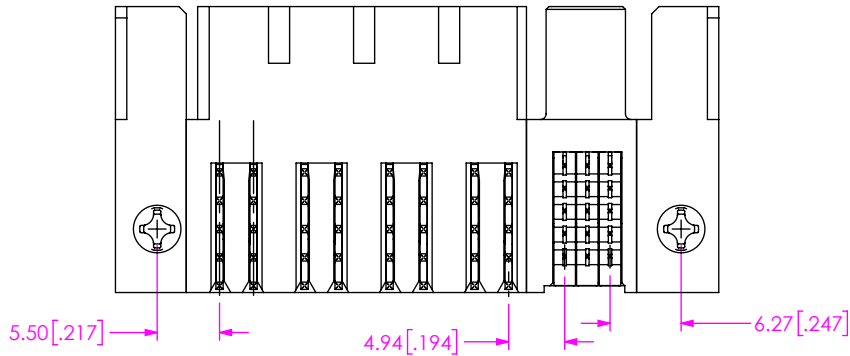
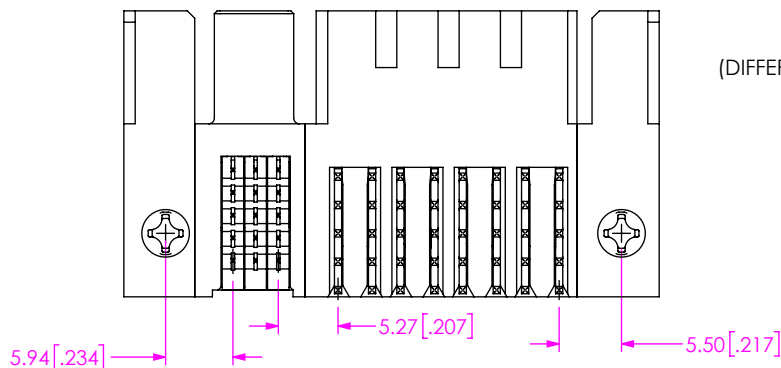

FIG 6
ET60S-D04-5-03-000-X-R1-S SHOWN
(DIFFERENT AS SHOWN, OTHERWISE SAME AS FIG 4)



F:\DWG\MISC\MKTG\ET60S-XXX-X-XX-XXX-X-RX-X-MKT.SLDDRW

PROPRIETARY NOTE

THIS DOCUMENT CONTAINS CONFIDENTIAL AND PROPRIETARY INFORMATION AND ALL DESIGN, MANUFACTURING, REPRODUCTION, USE, PATENT RIGHTS AND SALES RIGHTS ARE EXPRESSLY RESERVED BY SAMTEC, INC. THIS DOCUMENT SHALL NOT BE DISCLOSED, IN WHOLE OR PART, TO ANY UNAUTHORIZED PERSON OR ENTITY NOR REPRODUCED, TRANSFERRED OR INCORPORATED IN ANY OTHER PROJECT IN ANY MANNER WITHOUT THE EXPRESS WRITTEN CONSENT OF SAMTEC, INC.

SHEET SCALE: 2:1



520 PARK EAST BLVD., NEW ALBANY, IN 47150
PHONE: 812-944-6733 FAX: 812-948-5047
e-Mail: info@SAMTEC.com code 55322

DESCRIPTION:
ET60 RA POWER/ SIGNAL SOCKET

DWG. NO.
ET60S-XXX-X-XX-XXX-X-RX-X

BY: TOBIN Q 9/4/2023 SHEET 4 OF 10

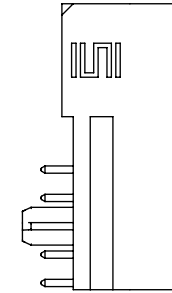
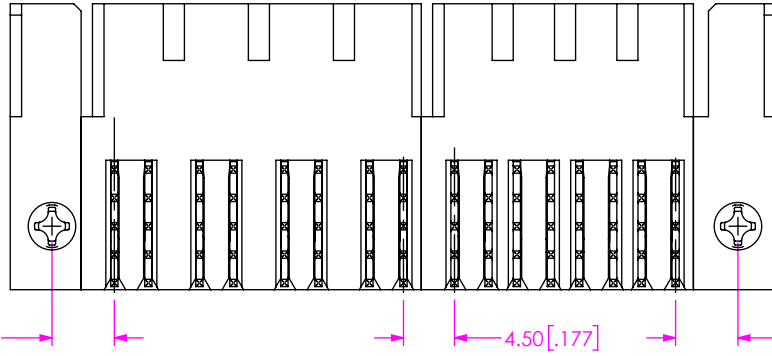
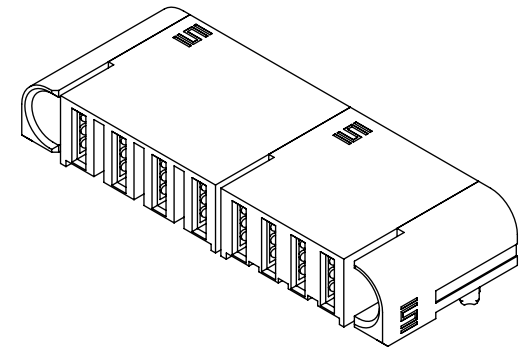
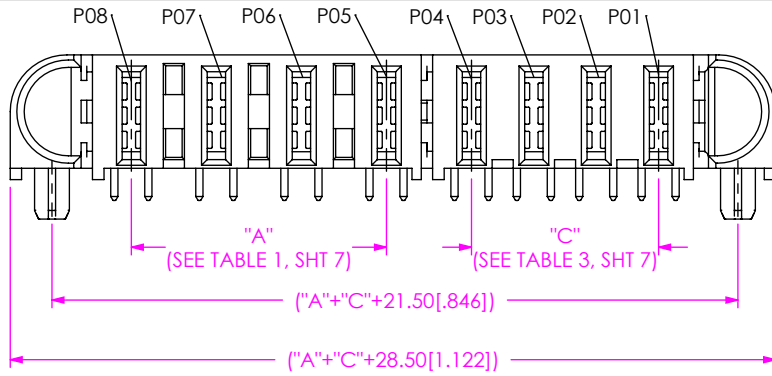

FIG 7
ET60S-D04-0-00-A04-X-R1-S SHOWN
(DIFFERENT AS SHOWN, OTHERWISE SAME AS FIG 1)

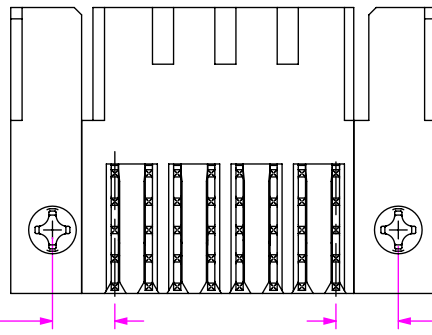
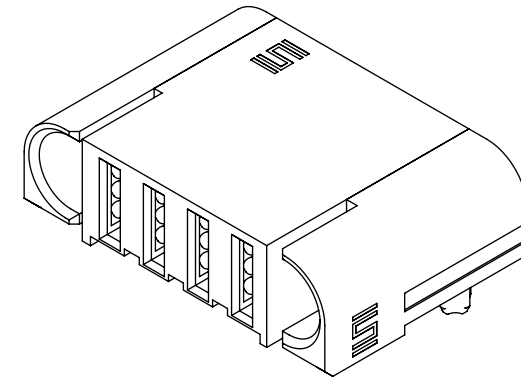
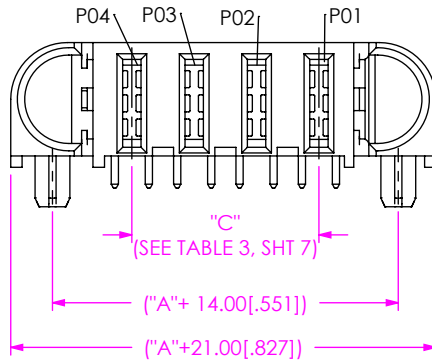

FIG 8
ET60S-D04-0-00-000-X-R1-S SHOWN
(DIFFERENT AS SHOWN, OTHERWISE SAME AS FIG 1)

PROPRIETARY NOTE
THIS DOCUMENT CONTAINS CONFIDENTIAL AND PROPRIETARY INFORMATION AND ALL DESIGN, MANUFACTURING, REPRODUCTION, USE, PATENT RIGHTS AND SALES RIGHTS ARE EXPRESSLY RESERVED BY SAMTEC, INC. THIS DOCUMENT SHALL NOT BE DISCLOSED, IN WHOLE OR PART, TO ANY UNAUTHORIZED PERSON OR ENTITY NOR REPRODUCED, TRANSFERRED OR INCORPORATED IN ANY OTHER PROJECT IN ANY MANNER WITHOUT THE EXPRESS WRITTEN CONSENT OF SAMTEC, INC.



520 PARK EAST BLVD., NEW ALBANY, IN 47150
PHONE: 812-944-6733 FAX: 812-948-5047
e-Mail: info@SAMTEC.com code 55322

SHEET SCALE: 3:2

DESCRIPTION:
ET60 RA POWER/ SIGNAL SOCKET

DWG. NO.
ET60S-XXX-X-XX-XXX-X-RX-X

BY: TOBIN Q 9/4/2023 SHEET 5 OF 10

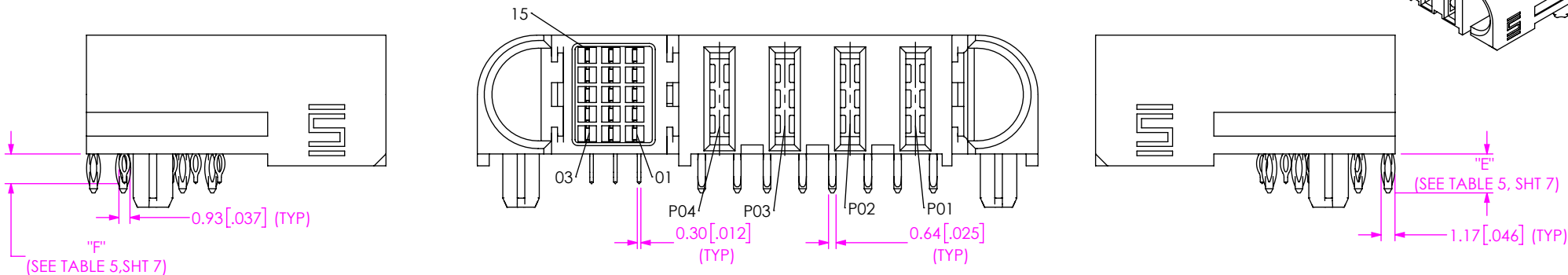
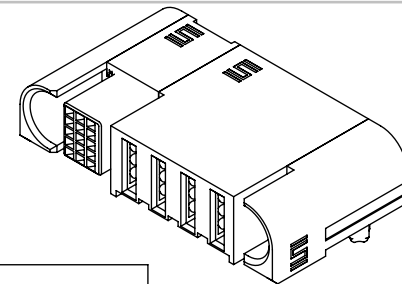

FIG 9
 ET60S-D04-5-03-000-X-RP-S SHOWN
 (DIFFERENT AS SHOWN, OTHERWISE SAME AS FIG 4)

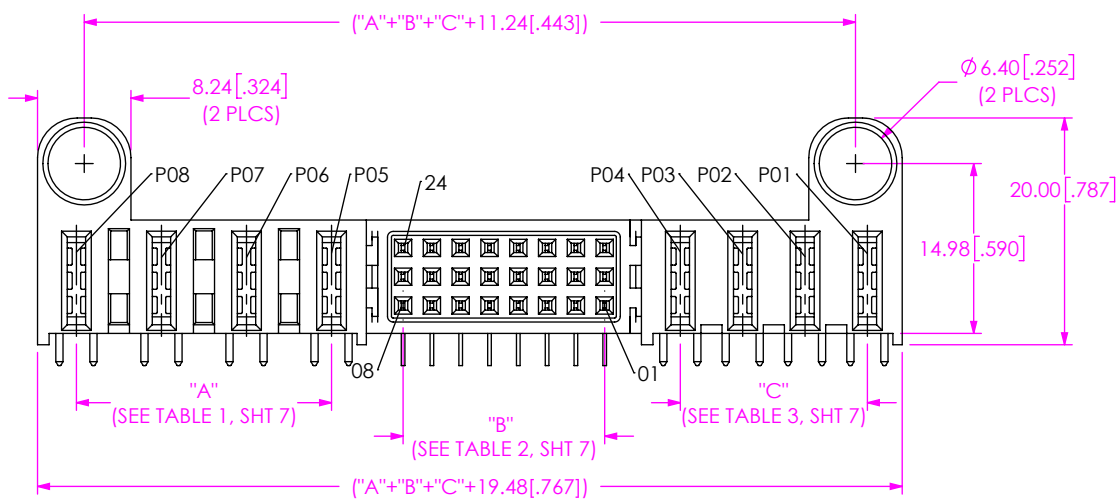
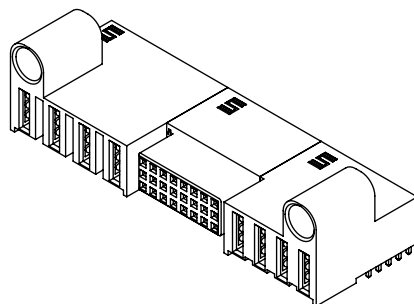

FIG 10
 ET60S-D04-3-08-A04-X-R1-T SHOWN
 (DIFFERENT AS SHOWN, OTHERWISE SAME AS FIG 1)



PROPRIETARY NOTE

THIS DOCUMENT CONTAINS CONFIDENTIAL AND PROPRIETARY INFORMATION AND ALL DESIGN, MANUFACTURING, REPRODUCTION, USE, PATENT RIGHTS AND SALES RIGHTS ARE EXPRESSLY RESERVED BY SAMTEC, INC. THIS DOCUMENT SHALL NOT BE DISCLOSED, IN WHOLE OR PART, TO ANY UNAUTHORIZED PERSON OR ENTITY NOR REPRODUCED, TRANSFERRED OR INCORPORATED IN ANY OTHER PROJECT IN ANY MANNER WITHOUT THE EXPRESS WRITTEN CONSENT OF SAMTEC, INC.

SHEET SCALE: 3:2



520 PARK EAST BLVD., NEW ALBANY, IN 47150
 PHONE: 812-944-6733 FAX: 812-948-5047
 e-Mail: info@SAMTEC.com code 55322

DESCRIPTION:
 ET60 RA POWER/ SIGNAL SOCKET

DWG. NO.
 ET60S-XXX-X-XX-XXX-X-RX-X

BY: TOBIN Q 9/4/2023 SHEET 6 OF 10

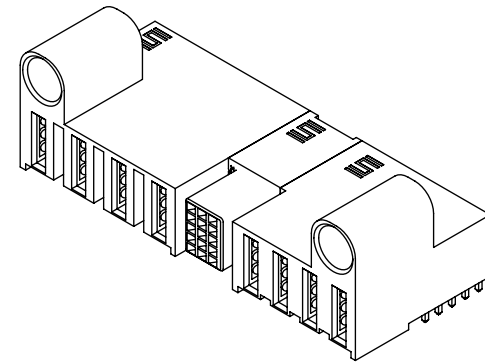
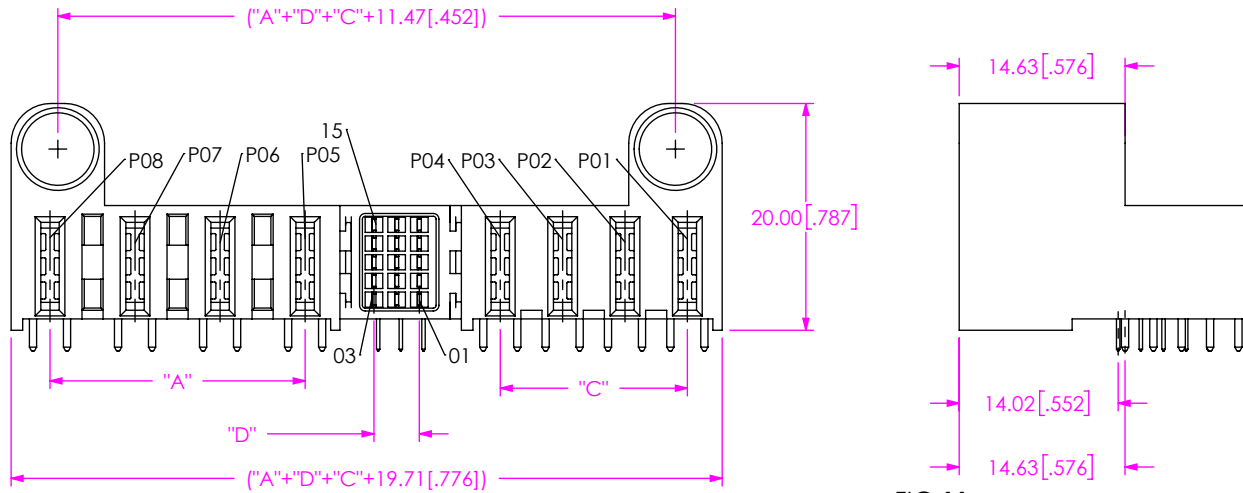

FIG 11
ET60S-D04-5-03-A04-X-R1-T SHOWN
(DIFFERENT AS SHOWN, OTHERWISE SAME AS FIG 4)

TABLE 1 (SEE NOTE 3)		
POWER POS (LEFT)	"A"	
	DC POWER	AC POWER
-01	N/A	N/A
-02	5.50 [.217]	7.50 [.295]
-03	11.00 [.433]	15.00 [.591]
-04	16.50 [.650]	22.50 [.886]
-05	22.00 [.866]	30.00 [1.181]
-06	27.50 [1.083]	37.50 [1.476]
-07	33.00 [1.299]	/
-08	38.50 [1.516]	/
-09	44.00 [1.732]	/
-10	49.50 [1.949]	/

TABLE 2 (SEE NOTE 4)	
SIGNAL POS (-3 ROWS)	"B"
-02	2.54 [.100]
-04	7.62 [.300]
-06	12.70 [.500]
-08	17.78 [.700]
-10	22.86 [.900]
-12	27.94 [1.100]

TABLE 3 (SEE NOTE 3)		
POWER POS (RIGHT)	"C"	
	DC POWER	AC POWER
-01	N/A	N/A
-02	5.50 [.217]	7.50 [.295]
-03	11.00 [.433]	15.00 [.591]
-04	16.50 [.650]	22.50 [.886]
-05	22.00 [.866]	30.00 [1.181]
-06	27.50 [1.083]	37.50 [1.476]
-07	33.00 [1.299]	/
-08	38.50 [1.516]	/
-09	44.00 [1.732]	/
-10	49.50 [1.949]	/

TABLE 4 (SEE NOTE 4)	
SIGNAL POS (-5 ROWS)	"D"
-01	N/A
-02	2.00 [.079]
-03	4.00 [.157]
-04	6.00 [.236]
-05	8.00 [.315]
-06	10.00 [.394]
-07	12.00 [.472]
-08	14.00 [.551]

TABLE 6 (SEE NOTE 3)	
NO OF SPLIT POWER (LEFT)	"G"
-01	N/A
-02	8.00 [.315]
-03	16.00 [.630]
-04	24.00 [.945]

TABLE 5		
TAIL	"E"	"F"
-R1	2.84 [.112]	2.84 [.112]
-R2	3.61 [.142]	3.41 [.134]
-RP	3.28 [.129]	2.50 [.098]

TABLE 7 (SEE NOTE 3)	
NO OF SPLIT POWER (RIGHT)	"H"
-01	N/A
-02	8.00 [.315]
-03	16.00 [.630]
-04	24.00 [.945]

PROPRIETARY NOTE
THIS DOCUMENT CONTAINS CONFIDENTIAL AND PROPRIETARY INFORMATION AND ALL DESIGN, MANUFACTURING, REPRODUCTION, USE, PATENT RIGHTS AND SALES RIGHTS ARE EXPRESSLY RESERVED BY SAMTEC, INC. THIS DOCUMENT SHALL NOT BE DISCLOSED, IN WHOLE OR PART, TO ANY UNAUTHORIZED PERSON OR ENTITY NOR REPRODUCED, TRANSFERRED OR INCORPORATED IN ANY OTHER PROJECT IN ANY MANNER WITHOUT THE EXPRESS WRITTEN CONSENT OF SAMTEC, INC.



520 PARK EAST BLVD., NEW ALBANY, IN 47150
PHONE: 812-944-6733 FAX: 812-948-5047
e-Mail: info@SAMTEC.com code 55322

SHEET SCALE: 3:2

DESCRIPTION:
ET60 RA POWER/ SIGNAL SOCKET

DWG. NO.
ET60S-XXX-X-XX-XXX-X-RX-X

BY: TOBIN Q 9/4/2023 SHEET 7 OF 10

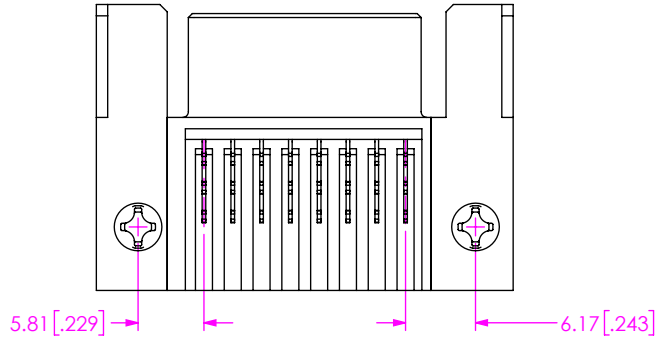
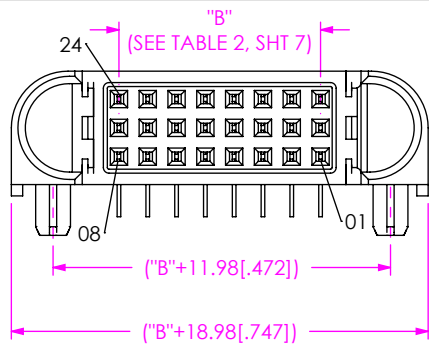

FIG 12
ET60S-000-3-08-000-X-R1-S SHOWN
(DIFFERENT AS SHOWN, OTHERWISE SAME AS FIG 1)

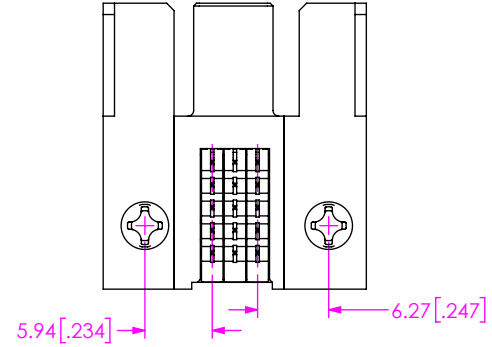
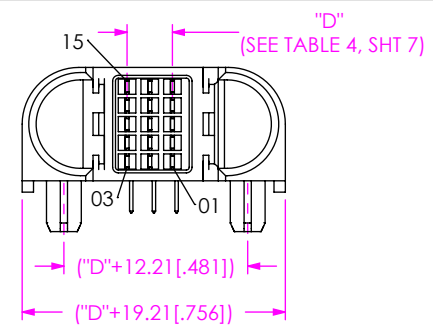

FIG 13
ET60S-000-5-03-000-X-R1-S SHOWN
(DIFFERENT AS SHOWN, OTHERWISE SAME AS FIG 4)

PROPRIETARY NOTE

THIS DOCUMENT CONTAINS CONFIDENTIAL AND PROPRIETARY INFORMATION AND ALL DESIGN, MANUFACTURING, REPRODUCTION, USE, PATENT RIGHTS AND SALES RIGHTS ARE EXPRESSLY RESERVED BY SAMTEC, INC. THIS DOCUMENT SHALL NOT BE DISCLOSED, IN WHOLE OR PART, TO ANY UNAUTHORIZED PERSON OR ENTITY NOR REPRODUCED, TRANSFERRED OR INCORPORATED IN ANY OTHER PROJECT IN ANY MANNER WITHOUT THE EXPRESS WRITTEN CONSENT OF SAMTEC, INC.



520 PARK EAST BLVD, NEW ALBANY, IN 47150
PHONE: 812-944-6733 FAX: 812-948-5047
e-Mail info@SAMTEC.com code 55322

SHEET SCALE: 3:2

DESCRIPTION:
ET60 RA POWER/ SIGNAL SOCKET

DWG. NO.
ET60S-XXX-X-XX-XXX-X-RX-X

BY: TOBIN Q 9/4/2023 SHEET 8 OF 10

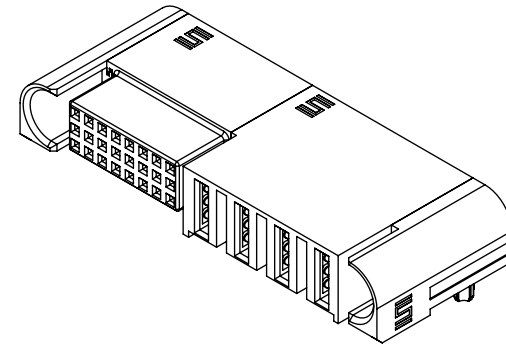
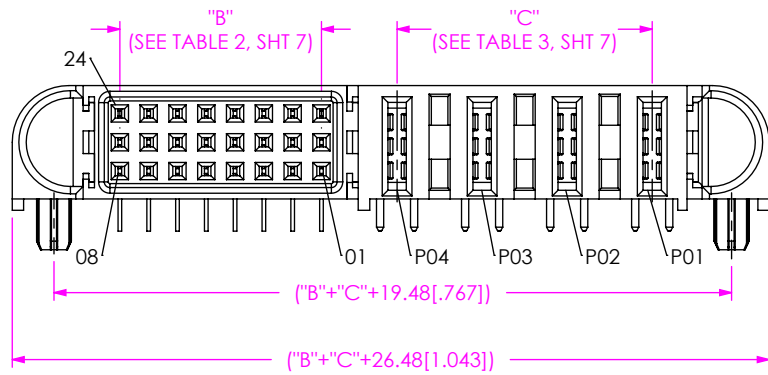
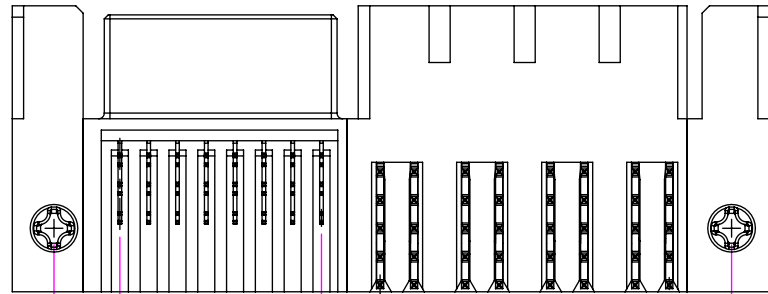

FIG 14
ET60S-A04-3-08-000-X-R1-S SHOWN
(DIFFERENT AS SHOWN, OTHERWISE SAME AS FIG 1)



5.81 [.229] 5.17 [.204] 5.50 [.217]

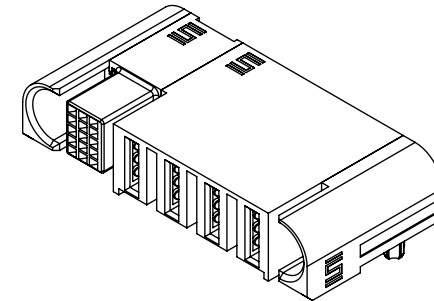
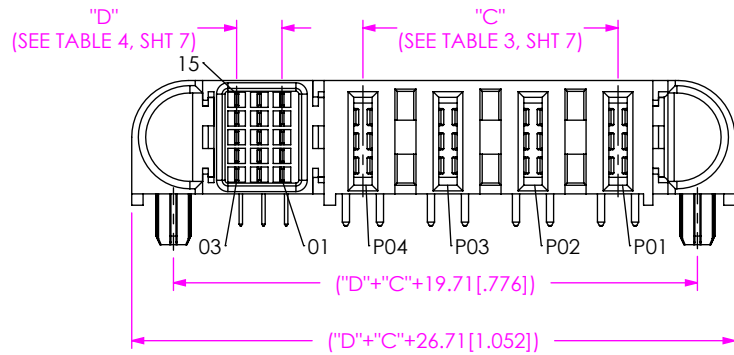
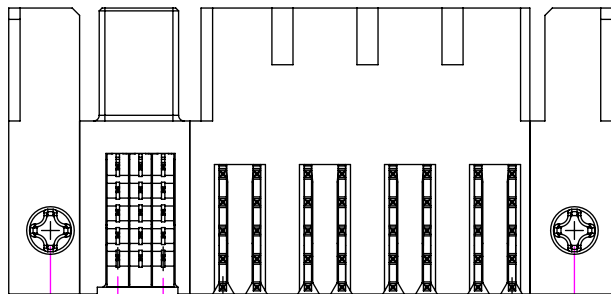

FIG 15
ET60S-A04-5-03-000-X-R1-S SHOWN
(DIFFERENT AS SHOWN, OTHERWISE SAME AS FIG 1)



5.94 [.234] 5.27 [.207] 5.50 [.217]

PROPRIETARY NOTE

THIS DOCUMENT CONTAINS CONFIDENTIAL AND PROPRIETARY INFORMATION AND ALL DESIGN, MANUFACTURING, REPRODUCTION, USE, PATENT RIGHTS AND SALES RIGHTS ARE EXPRESSLY RESERVED BY SAMTEC, INC. THIS DOCUMENT SHALL NOT BE DISCLOSED, IN WHOLE OR PART, TO ANY UNAUTHORIZED PERSON OR ENTITY NOR REPRODUCED, TRANSFERRED OR INCORPORATED IN ANY OTHER PROJECT IN ANY MANNER WITHOUT THE EXPRESS WRITTEN CONSENT OF SAMTEC, INC.



520 PARK EAST BLVD., NEW ALBANY, IN 47150
PHONE: 812-944-6733 FAX: 812-948-5047
e-Mail: info@SAMTEC.com code 53322

SHEET SCALE: 1.5:1

DESCRIPTION:
ET60 RA POWER/ SIGNAL SOCKET

DWG. NO.
ET60S-XXX-X-XX-XXX-X-RX-X

BY: TOBIN Q 9/4/2023 SHEET 9 OF 10

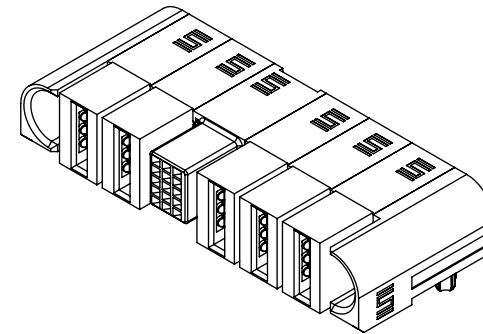
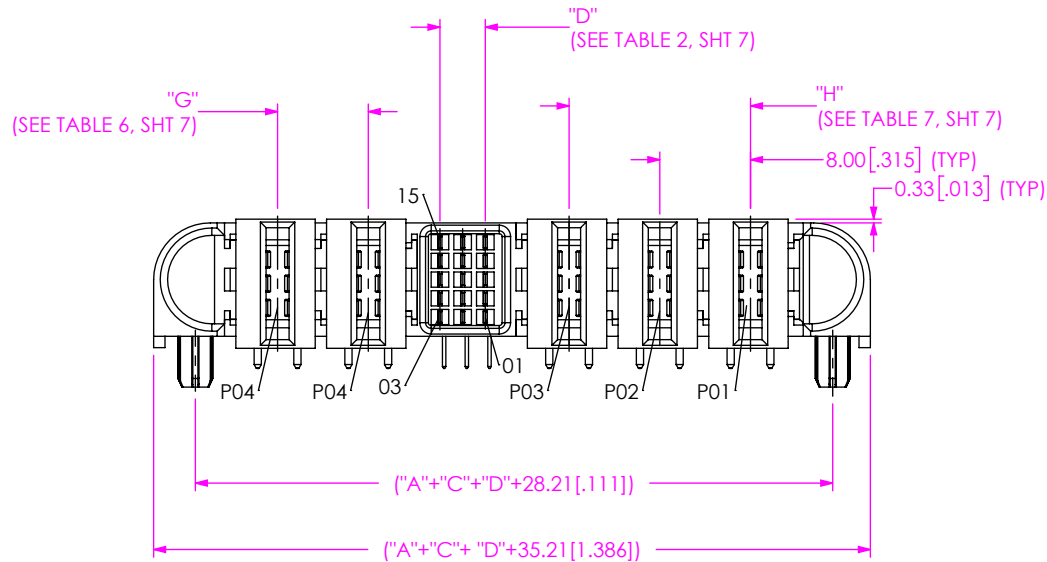
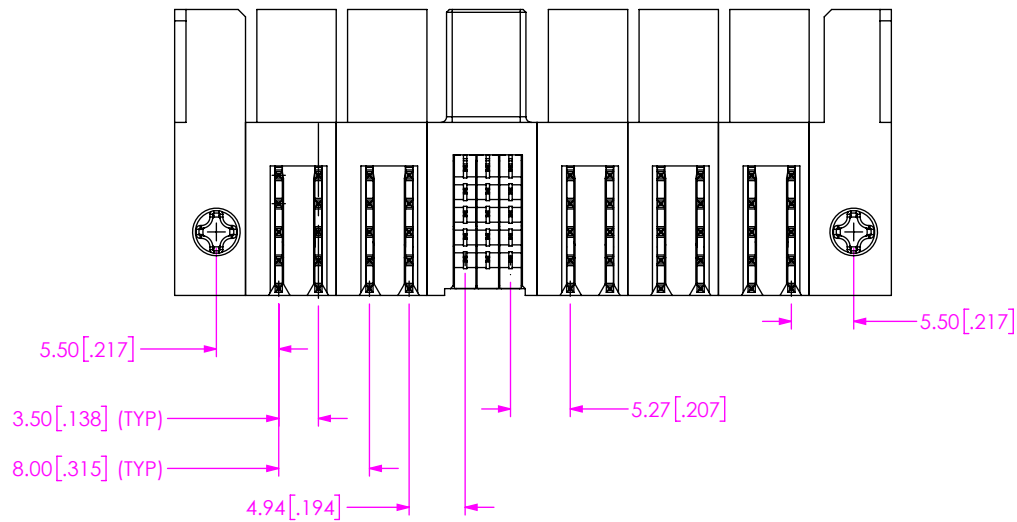

FIG 16
ET60S-S03-5-03-S02-X-R1-S SHOWN
(DIFFERENT AS SHOWN, OTHERWISE SAME AS FIG 4)



<p>PROPRIETARY NOTE</p> <p>THIS DOCUMENT CONTAINS CONFIDENTIAL AND PROPRIETARY INFORMATION AND ALL DESIGN, MANUFACTURING, REPRODUCTION, USE, PATENT RIGHTS AND SALES RIGHTS ARE EXPRESSLY RESERVED BY SAMTEC, INC. THIS DOCUMENT SHALL NOT BE DISCLOSED, IN WHOLE OR PART, TO ANY UNAUTHORIZED PERSON OR ENTITY NOR REPRODUCED, TRANSFERRED OR INCORPORATED IN ANY OTHER PROJECT IN ANY MANNER WITHOUT THE EXPRESS WRITTEN CONSENT OF SAMTEC, INC.</p>	 <p>520 PARK EAST BLVD., NEW ALBANY, IN 47150 PHONE: 812-944-6733 FAX: 812-948-5047 e-Mail info@SAMTEC.com code 55322</p>	
	<p>DESCRIPTION: ET60 RA POWER/ SIGNAL SOCKET</p>	
	<p>DWG. NO. ET60S-XXX-X-XX-XXX-X-RX-X</p>	
<p>SHEET SCALE: 1.5:1</p>	<p>BY: TOBIN Q</p>	<p>9/4/2023 SHEET 10 OF 10</p>