

ESD SENSITIVE

DO NOT SCALE FROM THIS PRINT

ASSEMBLY LENGTH LIMITS [cm]		
FIBER TYP	MIN	MAX
-5	10	100
-6	8	100
-7	10	300
-8	8	300

TABLE 2: LENGTH TOLERANCE	
ASSEMBLY LENGTH [cm]	TOLERANCE [cm]*
000-016	±0.16
017-999	±1%

* ROUNDED UP TO 2 DECIMAL PLACES

ETUO-U12-XX-XXX-0-X-1-X

DATA RATE
-10: 10.3125 Gbps

ASSEMBLY LENGTH
-XXX: LENGTH (cm) SEE TABLES 1, 2

FIBER TYPE
-5: BLACK JACKETED RIBBON WITH BOOT
-6: BLACK JACKETED RIBBON
-7: BLACK LOOSE TUBE WITH BOOT
-8: BLACK LOOSE TUBE

HEAT SINK
-1: FLAT
-2: PIN FIN
-3: FLAT WITH GROOVE (SEE NOTE 1)
-4: PCIe® PIN FIN

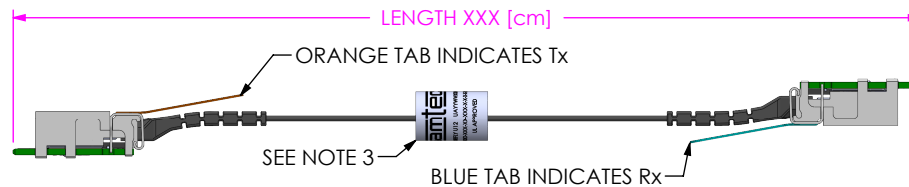

PART NUMBER ETUO-U12-XX-XXX-0-1-1-5 SHOWN



PART NUMBER ETUO-U12-XX-XXX-0-1-1-6 SHOWN

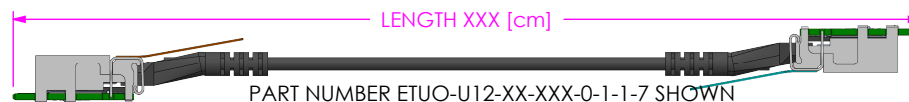

PART NUMBER ETUO-U12-XX-XXX-0-1-1-7 SHOWN



PART NUMBER ETUO-U12-XX-XXX-0-1-1-8 SHOWN

NOTES:

- PASS THROUGH ALLOWS ONE JACKETED RIBBON (FIBER TYPE -5/-6) OF CABLE LENGTH MAX 50 cm TO PASS ABOVE HEAT SINK AND UNDER COLD PLATE
- GROOVE ALLOWS ONE JACKETED RIBBON (FIBER TYPE -5/-6) OF CABLE LENGTH MAX 50 CM OR TWO CABLES OF JACKETED LOOSE TUBE (FIBER TYPE -7/-8) TO PASS ABOVE HEAT SINK AND UNDER COLD PLATE
- ALL CABLES WITH A LENGTH GREATER THAN 50 cm ARE LABELED. LABEL TO CONTAIN PART NUMBER AND SERIAL NUMBER INFORMATION
- YELLOW LATCH PINS NOT SHOWN FOR CLARITY. SEE FIREFLY INSTALLATION INSTRUCTIONS FOR MORE DETAILS

UNLESS OTHERWISE SPECIFIED, DIMENSIONS ARE IN MILLIMETERS. ALL DIMENSIONS ARE FOR REFERENCE ONLY

PROPRIETARY NOTE
THIS DOCUMENT CONTAINS CONFIDENTIAL AND PROPRIETARY INFORMATION AND ALL DESIGN, MANUFACTURING, REPRODUCTION, USE, PATENT RIGHTS AND SALES RIGHTS ARE EXPRESSLY RESERVED BY SAMTEC, INC. THIS DOCUMENT SHALL NOT BE DISCLOSED, IN WHOLE OR PART, TO ANY UNAUTHORIZED PERSON OR ENTITY NOR REPRODUCED, TRANSFERRED OR INCORPORATED IN ANY OTHER PROJECT IN ANY MANNER WITHOUT THE EXPRESS WRITTEN CONSENT OF SAMTEC, INC.



520 PARK EAST BLVD, NEW ALBANY, IN 47150
PHONE: 812-944-6733 FAX: 812-948-5047
e-Mail: info@SAMTEC.com code 55322

MATERIAL: DO NOT SCALE DRAWING SHEET SCALE: 1:1

DESCRIPTION: OPTICAL FIREFLY ASSEMBLY

DWG. NO. ETUO-U12-XX-XXX-0-X-1-X

BY: AARON B. 08/19/2020 SHEET 1 OF 4

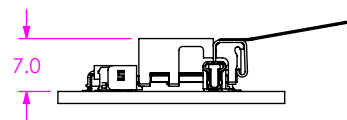
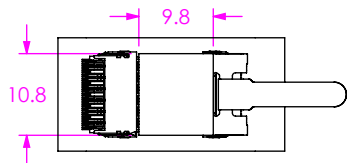
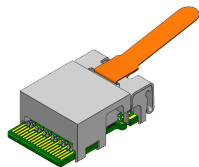

-1 FLAT HEAT SINK

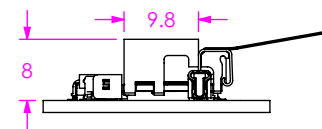
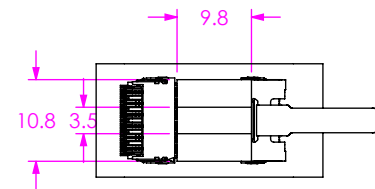
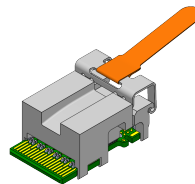

-3 FLAT HEAT SINK WITH PASS THROUGH

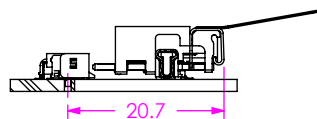

KEEP OUT AREA FOR DE-MATING
TYPICAL FOR HEAT SINKS -1/-2/-3/-4
REFER TO UEC5 FOOTPRINT DRAWING
FOR DETAILED KEEPOUT AREAS

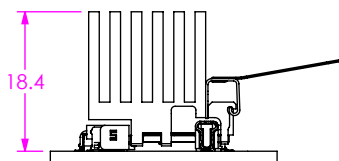
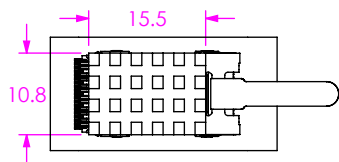
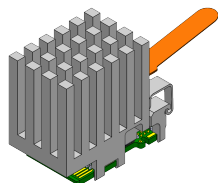

-2 PIN-FIN HEAT SINK

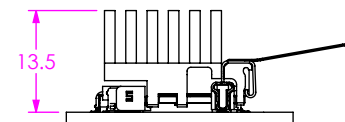
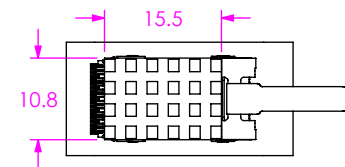
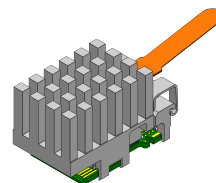

-4 LOW-PROFILE PIN-FIN HEAT SINK

PROPRIETARY NOTE
THIS DOCUMENT CONTAINS CONFIDENTIAL AND PROPRIETARY INFORMATION AND ALL DESIGN, MANUFACTURING, REPRODUCTION, USE, PATENT RIGHTS AND SALES RIGHTS ARE EXPRESSLY RESERVED BY SAMTEC, INC. THIS DOCUMENT SHALL NOT BE DISCLOSED, IN WHOLE OR PART, TO ANY UNAUTHORIZED PERSON OR ENTITY NOR REPRODUCED, TRANSFERRED OR INCORPORATED IN ANY OTHER PROJECT IN ANY MANNER WITHOUT THE EXPRESS WRITTEN CONSENT OF SAMTEC, INC.

SHEET SCALE: 1:1



520 PARK EAST BLVD., NEW ALBANY, IN 47150
PHONE: 812-944-6733 FAX: 812-948-5047
e-Mail: info@SAMTEC.com code 55322

DESCRIPTION:
OPTICAL FIREFLY ASSEMBLY

DWG. NO.
ETUO-U12-XX-XXX-0-X-1-X

BY: AARON B. 08/19/2020 SHEET 2 OF 4

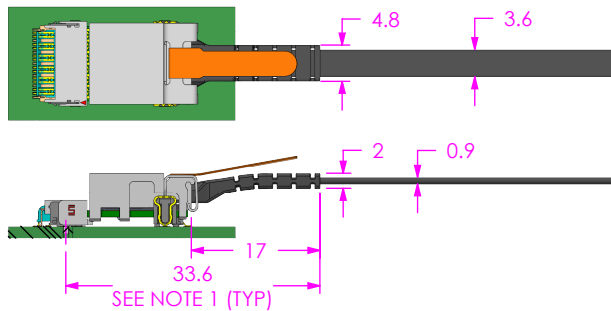

-5 FIBER TYPE, ≤ 50 cm LENGTH

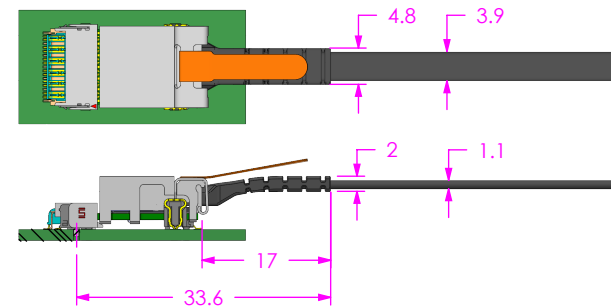

-5 FIBER TYPE, > 50 cm LENGTH

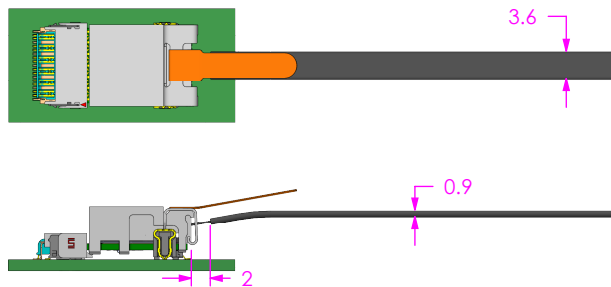

-6 FIBER TYPE, ≤ 50 cm LENGTH

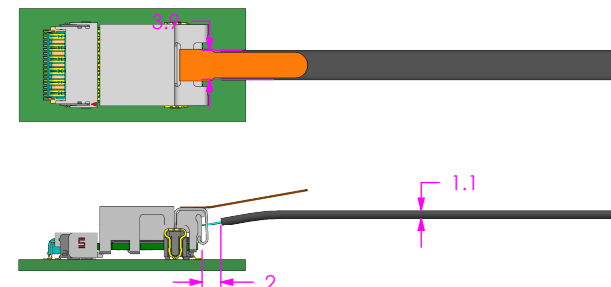

-6 FIBER TYPE, > 50 cm LENGTH

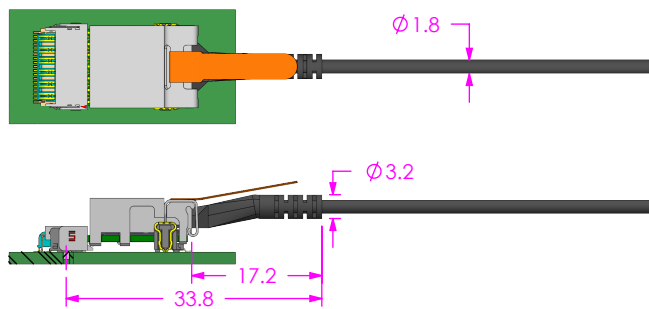

-7 FIBER TYPE

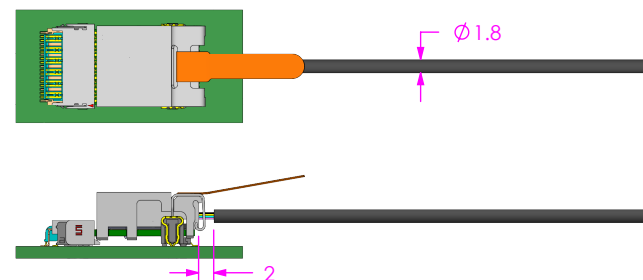

-8 FIBER TYPE

NOTES:
1. DIMENSIONED FROM THE CENTER OF THE ALIGNMENT PIN HOLE AS SHOWN ON THE UEC5/UCC8 CONNECTOR FOOTPRINT

PROPRIETARY NOTE
THIS DOCUMENT CONTAINS CONFIDENTIAL AND PROPRIETARY INFORMATION AND ALL DESIGN, MANUFACTURING, REPRODUCTION, USE, PATENT RIGHTS AND SALES RIGHTS ARE EXPRESSLY RESERVED BY SAMTEC, INC. THIS DOCUMENT SHALL NOT BE DISCLOSED, IN WHOLE OR PART, TO ANY UNAUTHORIZED PERSON OR ENTITY NOR REPRODUCED, TRANSFERRED OR INCORPORATED IN ANY OTHER PROJECT IN ANY MANNER WITHOUT THE EXPRESS WRITTEN CONSENT OF SAMTEC, INC.



520 PARK EAST BLVD., NEW ALBANY, IN 47150
PHONE: 812-944-6733 FAX: 812-948-5047
e-Mail: info@SAMTEC.com code 55322

SHEET SCALE: 1:1

DESCRIPTION:
OPTICAL FIREFLY ASSEMBLY

DWG. NO.
ETUO-U12-XX-XXX-0-X-1-X

BY: AARON B. 08/19/2020 SHEET 3 OF 4

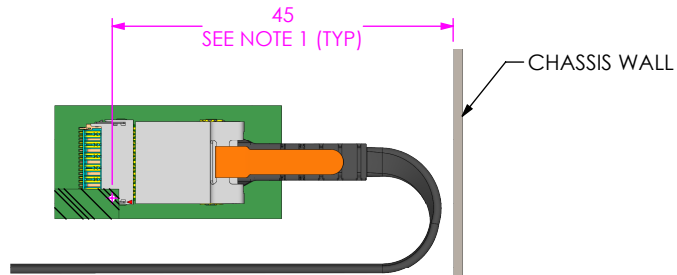

-5 FIBER TYPE RECOMMENDED CABLE ESCAPE CLEARANCE

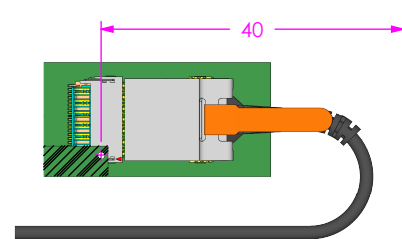

-7 FIBER TYPE RECOMMENDED CABLE ESCAPE CLEARANCE

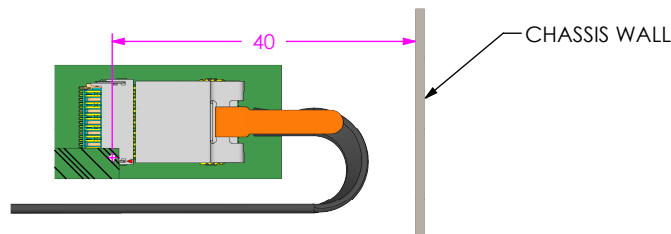

-6 FIBER TYPE RECOMMENDED CABLE ESCAPE CLEARANCE

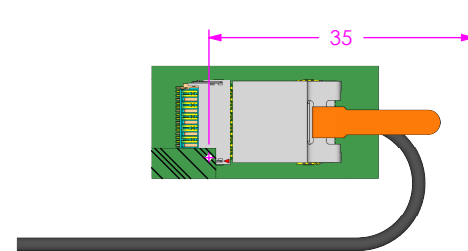

-8 FIBER TYPE RECOMMENDED CABLE ESCAPE CLEARANCE

NOTES:

1. DIMENSIONED FROM THE CENTER OF THE ALIGNMENT PIN HOLE AS SHOWN ON THE UEC5/UCC8 CONNECTOR FOOTPRINT
2. DUE TO THE COMPLIANT NATURE OF FIBER CABLE AND THE MOLDED FIBER BOOT COMPONENTS, THE DIMENSIONS SHOWN ON THIS SHEET ARE FOR GUIDANCE ONLY. EACH APPLICATION IS UNIQUE AND MAY RESULT IN UNIQUE CLEARANCE DIMENSIONS FOR THE CABLE ESCAPE.

<p>PROPRIETARY NOTE</p> <p>THIS DOCUMENT CONTAINS CONFIDENTIAL AND PROPRIETARY INFORMATION AND ALL DESIGN, MANUFACTURING, REPRODUCTION, USE, PATENT RIGHTS AND SALES RIGHTS ARE EXPRESSLY RESERVED BY SAMTEC, INC. THIS DOCUMENT SHALL NOT BE DISCLOSED, IN WHOLE OR PART, TO ANY UNAUTHORIZED PERSON OR ENTITY NOR REPRODUCED, TRANSFERRED OR INCORPORATED IN ANY OTHER PROJECT IN ANY MANNER WITHOUT THE EXPRESS WRITTEN CONSENT OF SAMTEC, INC.</p>	 <p>520 PARK EAST BLVD, NEW ALBANY, IN 47150 PHONE: 812-944-6733 FAX: 812-948-5047 e-Mail info@SAMTEC.com code 55322</p>
<p>DO NOT SCALE DRAWING SHEET SCALE: 1:1 INSULATOR: CONTACT OR TERMINAL: SHIELD: PHOS BRONZE PLATING: CONTACT AREA: .000010 REF GOLD REMAINDER: .000200 REF TIN</p>	<p>DESCRIPTION: OPTICAL FIREFLY ASSEMBLY</p> <p>DWG. NO. ETUO-U12-XX-XXX-0-X-1-X</p> <p>BY: AARON B. 08/19/2020 SHEET 4 OF 4</p>