

DO NOT SCALE FROM THIS PRINT

FTMH-1XX-XX-XX-DV-XX-X-XX

TABLE 1		
LEAD STYLE	"A"	"B"
-02	.075 [1.91]	.075[1.91]
-03	.065 [1.65]	.055[1.40]

TABLE 4	
POSITIONS	COPLANARITY
02 THRU 29	.004[0.10]
30 THRU 50	.006[0.15]

No OF POS PER ROW  
-02 THRU -50  
(SEE NOTE 10)

LEAD STYLE  
-02: .075 [1.91]  
(USE T-1S16-03-XX-2)  
-03: .065 [1.65]  
(USE T-1S16-04-XX-2)

PLATING SPECIFICATION  
-L: 10µ" LIGHT SELECTIVE GOLD IN CONTACT AREA, MATTE TIN ON TAIL  
-F: 3µ" FLASH SELECTIVE GOLD IN CONTACT AREA, MATTE TIN ON TAIL  
-H: 30µ" HEAVY GOLD IN CONTACT AREA, 3µ" FLASH GOLD ON TAIL  
-G: 10µ" GOLD IN CONTACT AREA, 3µ" FLASH GOLD ON TAIL  
-LM: 10µ" LIGHT SELECTIVE GOLD IN CONTACT AREA, MATTE TIN ON TAIL  
-FM: 3µ" FLASH SELECTIVE GOLD IN CONTACT AREA, MATTE TIN ON TAIL

PACKAGING (SEE NOTE 5)  
BLANK: TUBES (SEE NOTE 11)  
-TR: TAPE & REEL (SEE NOTES 12 & 13)  
-FR: FULL REEL QTY TAPE & REEL (SEE NOTES 12 & 13)

PICK & PLACE OPTION  
-P: PICK & PLACE PAD (USE PPP-30)  
(USE PPP-30-NT FOR TAPE & REEL)  
(SEE FIG 3, SHT 4; 6 POS MIN)

OPTIONS  
-ES: SNAP ON END SHROUDS  
(SEE FIG 2, SHT 2; 9 POS MIN)  
MOLD TO POSITION END SHROUDS  
(5 POS MIN; SEE FIG 2, SHT 2)  
(SAMTEC DISCRETION ON WHICH END SHROUDS ARE USED FOR POSITIONS -09 AND GREATER)  
-EP: GUIDE POST (SEE FIG 4, SHT 4; 9 POS MIN)  
(USE ONLY WHEN MATING WITH A CLM)  
-EC: LOCKING CLIP (SEE FIG 5, SHT 4)  
(SEE NOTE 9; 9 POS MIN)  
-A: ALIGNMENT PIN (SEE FIG 6 & 7, SHT 5)  
(SAMTEC DISCRETION ON WHICH -A PIN IS USED)  
(MOLDED: 3 POS MIN, USE FTMH-75-D-XX)  
(STAKED: 7 POS MIN, USE FTMH-60-D)

ROW SPECIFICATION  
-DV: DOUBLE ROW VERTICAL  
(USE FTMH-75-D)

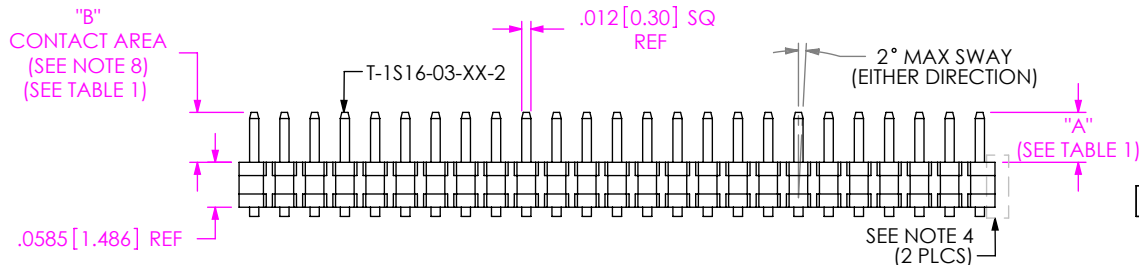
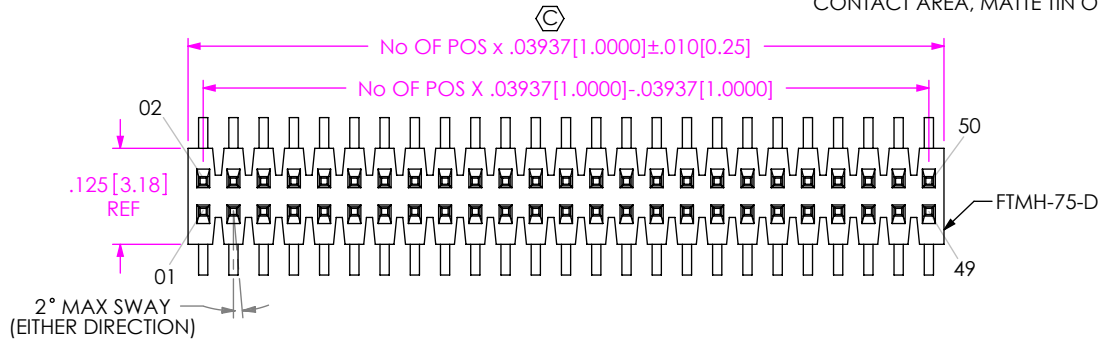
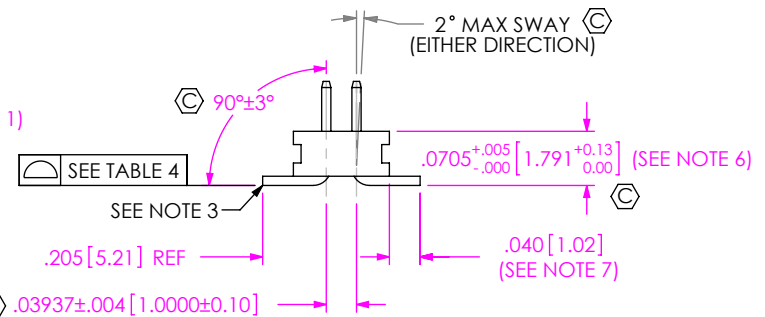


FIG 1  
FTMH-125-03-X-DV SHOWN

NOTES:

- REPRESENTS CRITICAL DIMENSION.
- MINIMUM PUSHOUT FORCE: 1.0 LB = 16 OZ.
- MAXIMUM BURR: .003 [0.08]
- MAXIMUM CUT FLASH: .010 [0.25]
- POSITIONS -02 THRU -04 TO BE LAYER PACKAGED.
- MEASURED AT BEND RADIUS.
- SHEAR TAILS TO DIMENSION SHOWN.
- FOR SELECTIVE PLATING OPTIONS, GOLD PLATING TO BE ON POST, TIN PLATING TO BE ON TAIL.
- DUE TO THE HIGH AMOUNT OF INSERTION FORCE NEEDED, THE -EC OPTION IS NOT COMPATIBLE WITH AUTO PLACEMENT. SAMTEC RECOMMENDS MANUAL PLACEMENT FOR ALL ASSEMBLIES WITH THE -EC OPTION.
- NUMBER OF POSITIONS MAY BE AS HIGH AS -75 FOR SAMTEC MANUFACTURING ONLY.
- TUBES ARE STANDARD PACKAGING.
- ORDERS WILL BE PACKAGED ACCORDING TO THE SAMTEC PACKAGING EFFICIENCY STANDARDS (SPES) FOUND ON WWW.SAMTEC.COM.
- ATTACH LABEL TO EACH REEL.



UNLESS OTHERWISE SPECIFIED, DIMENSIONS ARE IN INCHES.

TOLERANCES ARE:

DECIMALS ANGLES  
.XX: ±.01 [0.3]  
.XXX: ±.005 [0.13]  
.XXXX: ±.0020 [0.051]

PROPRIETARY NOTE

THIS DOCUMENT CONTAINS CONFIDENTIAL AND PROPRIETARY INFORMATION AND ALL DESIGN, MANUFACTURING, REPRODUCTION, USE, PATENT RIGHTS AND SALES RIGHTS ARE EXPRESSLY RESERVED BY SAMTEC, INC. THIS DOCUMENT SHALL NOT BE DISCLOSED, IN WHOLE OR PART, TO ANY UNAUTHORIZED PERSON OR ENTITY NOR REPRODUCED, TRANSFERRED OR INCORPORATED IN ANY OTHER PROJECT IN ANY MANNER WITHOUT THE EXPRESS WRITTEN CONSENT OF SAMTEC, INC.



520 PARK EAST BLVD, NEW ALBANY, IN 47150  
PHONE: 812-944-6733 FAX: 812-948-5047  
e-Mail: info@SAMTEC.com code: 55322

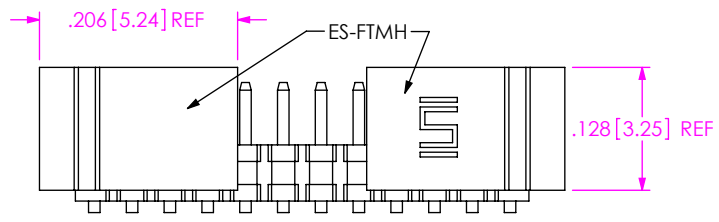
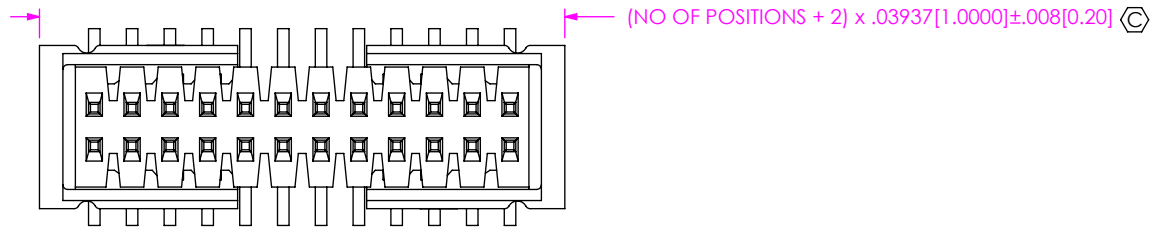
MATERIAL DO NOT SCALE DRAWING SHEET SCALE: 5:1

INSULATOR:  
BLACK, LCP, UL-94-V-0  
TERMINAL:  
PHOSPHOR BRONZE

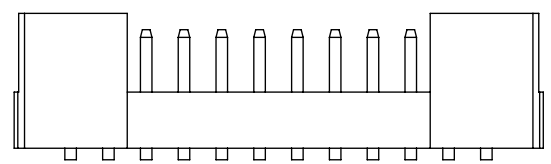
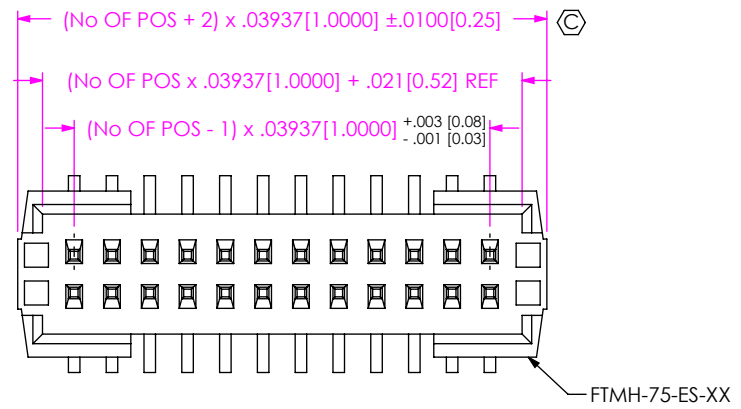
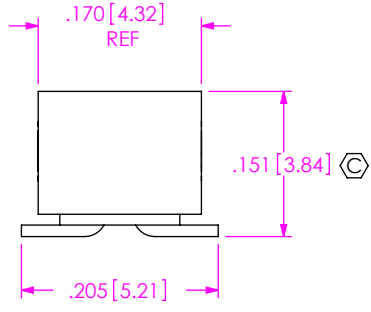
DESCRIPTION:  
1mm x 1mm DOUBLE VERTICAL SMT TERMINAL STRIP

DWG. NO.  
FTMH-1XX-XX-XX-DV-XX-X-XX

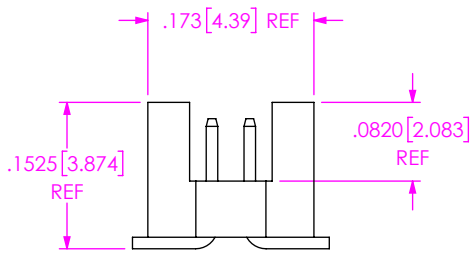
BY: PURVIS 04/22/96 SHEET 1 OF 6



SNAP ON END SHROUDS



MOLDED TO POSITION END SHROUDS



**FIG 2**  
 -ES: END SHROUDS  
 FTMH-112-02-X-DV-ES SHOWN  
 (DIFFERENT AS SHOWN, OTHERWISE SAME AS FIG 1)

**PROPRIETARY NOTE**  
 THIS DOCUMENT CONTAINS CONFIDENTIAL AND PROPRIETARY INFORMATION AND ALL DESIGN, MANUFACTURING, REPRODUCTION, USE, PATENT RIGHTS AND SALES RIGHTS ARE EXPRESSLY RESERVED BY SAMTEC, INC. THIS DOCUMENT SHALL NOT BE DISCLOSED, IN WHOLE OR PART, TO ANY UNAUTHORIZED PERSON OR ENTITY NOR REPRODUCED, TRANSFERRED OR INCORPORATED IN ANY OTHER PROJECT IN ANY MANNER WITHOUT THE EXPRESS WRITTEN CONSENT OF SAMTEC, INC.

DO NOT SCALE DRAWING

SHEET SCALE: 5:1

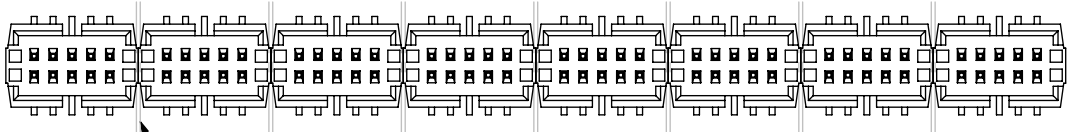


520 PARK EAST BLVD, NEW ALBANY, IN 47150  
 PHONE: 812-944-6733 FAX: 812-948-5047  
 e-Mail: info@SAMTEC.com code: 55322

DESCRIPTION:  
 1mm x 1mm DOUBLE VERTICAL SMT TERMINAL STRIP

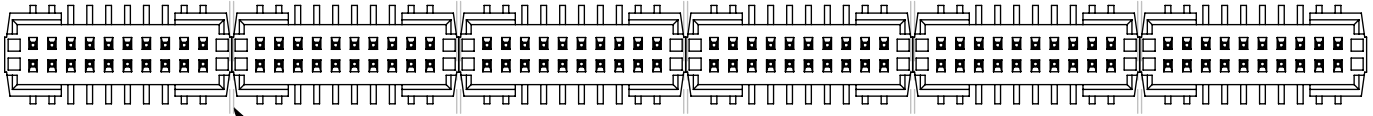
DWG. NO.  
**FTMH-1XX-XX-XX-DV-XX-X-XX**

BY: PURVIS 04/22/96 SHEET 2 OF 6



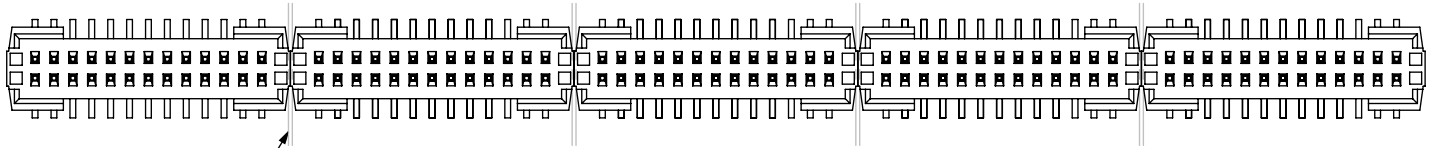
THEORETICAL CUT LINES

FTMH-105-XX-XX-DV-ES SHOWN (BEFORE CUT)



THEORETICAL CUT LINES

FTMH-110-XX-XX-DV-ES SHOWN (BEFORE CUT)



THEORETICAL CUT LINES

FTMH-113-XX-XX-DV-ES SHOWN (BEFORE CUT)

**PROPRIETARY NOTE**  
 \* THIS DOCUMENT CONTAINS CONFIDENTIAL AND PROPRIETARY INFORMATION AND ALL DESIGN, MANUFACTURING, REPRODUCTION, USE, PATENT RIGHTS AND SALES RIGHTS ARE EXPRESSLY RESERVED BY SAMTEC, INC. THIS DOCUMENT SHALL NOT BE DISCLOSED, IN WHOLE OR PART, TO ANY UNAUTHORIZED PERSON OR ENTITY NOR REPRODUCED, TRANSFERRED OR INCORPORATED IN ANY OTHER PROJECT IN ANY MANNER WITHOUT THE EXPRESS WRITTEN CONSENT OF SAMTEC, INC. \*

DO NOT SCALE DRAWING

SHEET SCALE: 5:1



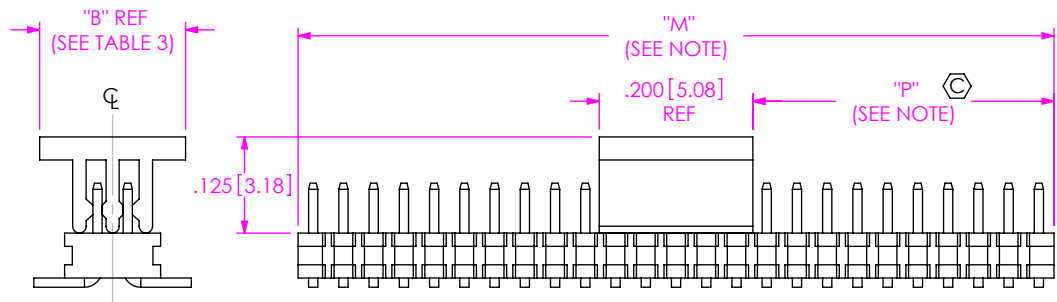
520 PARK EAST BLVD, NEW ALBANY, IN 47150  
PHONE: 812-944-6733 FAX: 812-948-5047  
e-Mail: info@SAMTEC.com code: 55322

DESCRIPTION:  
1mm x 1mm DOUBLE VERTICAL SMT TERMINAL STRIP

DWG. NO.  
**FTMH-1XX-XX-XX-DV-XX-X-XX**

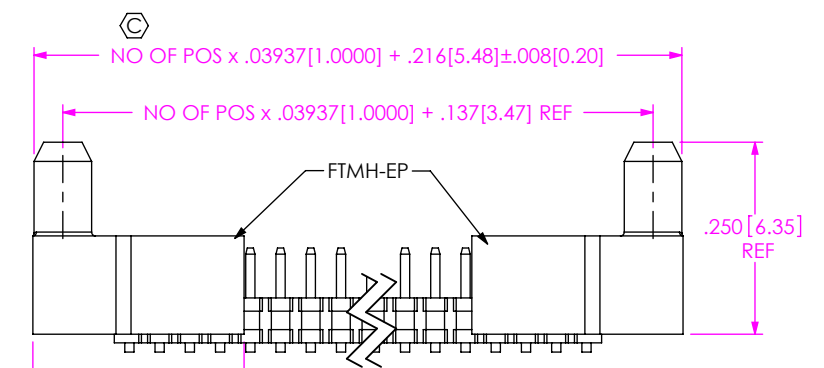
BY: PURVIS 04/22/96 SHEET 3 OF 6

NOTE  
 "M" = USED MEASURED DIMENSION (REF)  
 "P" =  $(("M" - .200[5.08]) / 2) \pm .020[.51]$

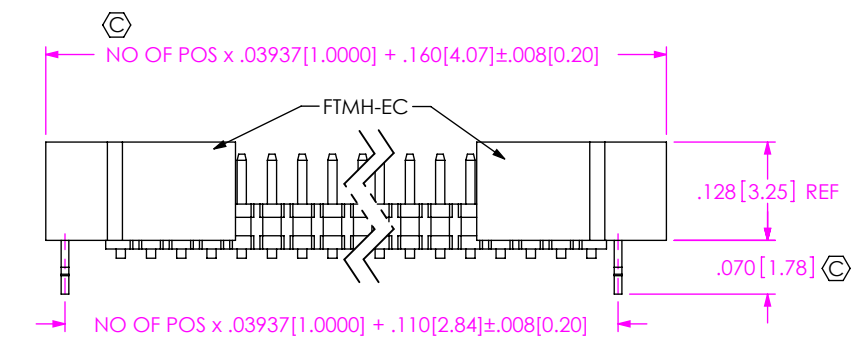


**FIG 3**  
 -P: PICK & PLACE PAD  
 FTMH-125-03-X-DV-P SHOWN  
 (DIFFERENT AS SHOWN, OTHERWISE SAME AS FIG 1)

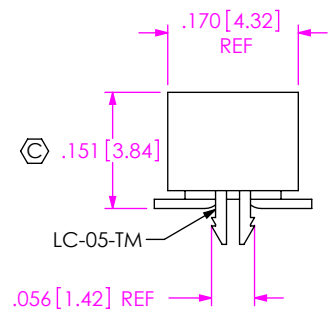
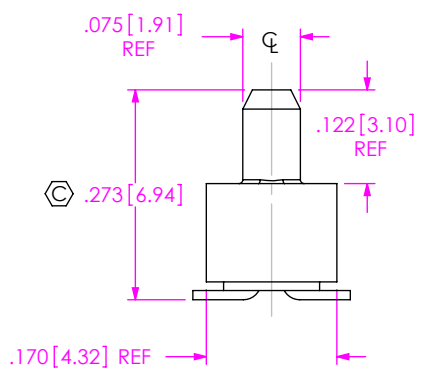
TABLE 3	
PAD	"B"
PPP-30	.125[3.18]
PPP-30-NT	.190[4.83]



**FIG 4**  
 -EP: GUIDE POST  
 FTMH-125-03-X-DV-EP SHOWN  
 (DIFFERENT AS SHOWN, OTHERWISE SAME AS FIG 1)



**FIG 5**  
 -EC: LOCKING CLIP  
 FTMH-125-03-X-DV-EC SHOWN  
 (DIFFERENT AS SHOWN, OTHERWISE SAME AS FIG 1)



**PROPRIETARY NOTE**  
 THIS DOCUMENT CONTAINS CONFIDENTIAL AND PROPRIETARY INFORMATION AND ALL DESIGN, MANUFACTURING, REPRODUCTION, USE, PATENT RIGHTS AND SALES RIGHTS ARE EXPRESSLY RESERVED BY SAMTEC, INC. THIS DOCUMENT SHALL NOT BE DISCLOSED, IN WHOLE OR PART, TO ANY UNAUTHORIZED PERSON OR ENTITY NOR REPRODUCED, TRANSFERRED OR INCORPORATED IN ANY OTHER PROJECT IN ANY MANNER WITHOUT THE EXPRESS WRITTEN CONSENT OF SAMTEC, INC.

DO NOT SCALE DRAWING

SHEET SCALE: 5:1

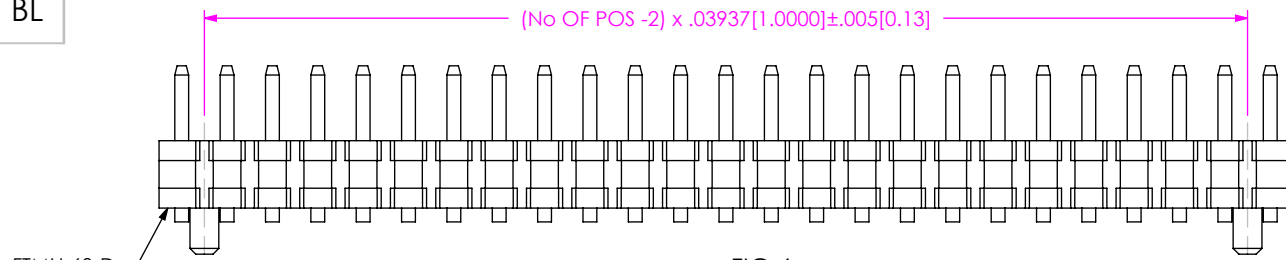


520 PARK EAST BLVD, NEW ALBANY, IN 47150  
 PHONE: 812-944-6733 FAX: 812-948-5047  
 e-Mail: info@SAMTEC.com code: 55322

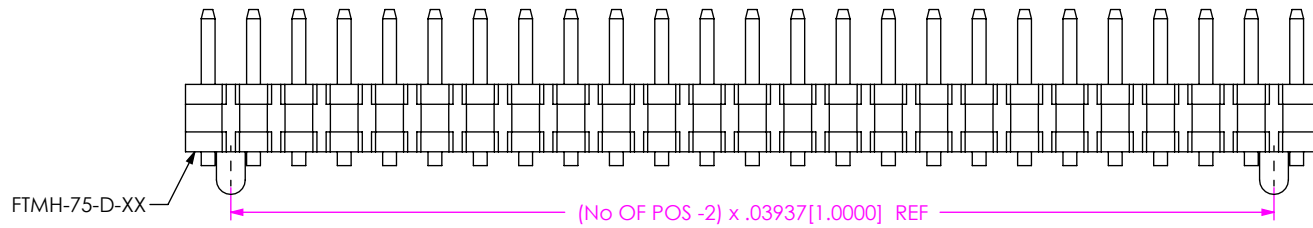
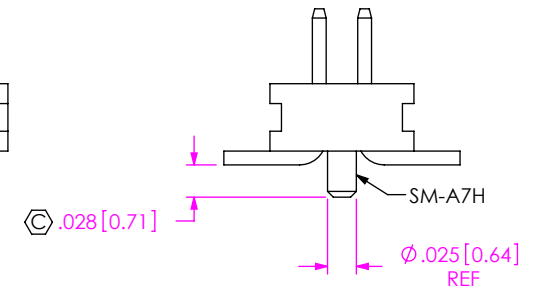
DESCRIPTION:  
 1mm x 1mm DOUBLE VERTICAL SMT TERMINAL STRIP

DWG. NO.  
**FTMH-1XX-XX-XX-DV-XX-X-XX**

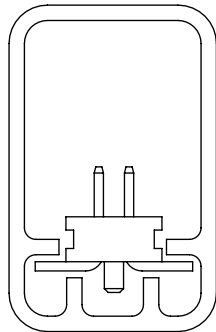
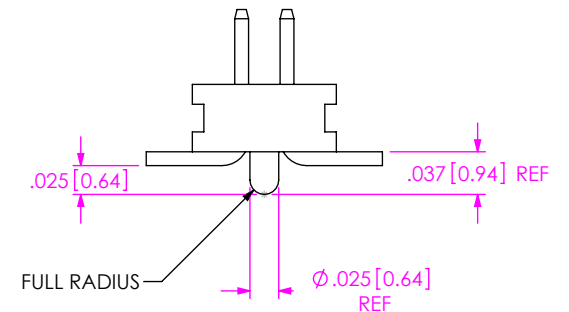
BY: PURVIS 04/22/96 SHEET 4 OF 6



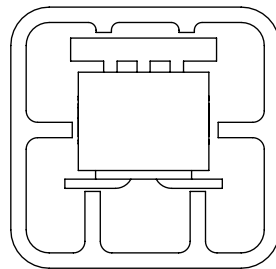
**FIG 6**  
 -A: ALIGNMENT PIN (STAKED)  
 (MIN 7 POSITIONS)  
 FTMH-125-03-X-DV-A SHOWN  
 (DIFFERENT AS SHOWN, OTHERWISE SAME AS FIG 1)



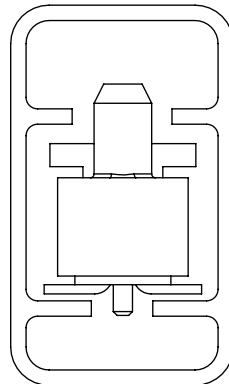
**FIG 7**  
 -A: ALIGNMENT PIN (MOLDED)  
 (MIN 3 POSITIONS)  
 FTMH-125-03-X-DV-A SHOWN  
 (DIFFERENT AS SHOWN, OTHERWISE SAME AS FIG 1)



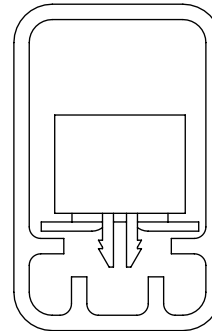
-A OPTION  
 PT-1-24-01-60



-ES-P OPTION  
 PT-1-24-01-63



-EP, -EP-A & -EP-A-P OPTION  
 PT-1-24-02-15



-EC OPTION  
 PT-1-24-01-60

**PACKAGING VIEWS**

**TABLE 2**  
 (SEE NOTE 5 FOR PACKAGING NOTES)

LEAD STYLE	OPTION (S)	PACKAGING TUBE	TUBE PLUG
-02, -03	-NONE	PT-1-24-01-60	TP-03 (x 2)
-02, -03	-A	PT-1-24-01-60	TP-03 (x 2)
-02, -03	-P, -A-P	PT-1-24-01-60	TP-03 (x 2)
-02, -03	-ES, -ES-P, -ES-A	PT-1-24-01-63	TP-24 (x 2)
-02, -03	-EC, -EC-P, -EC-A	PT-1-24-01-60	TP-03 (x 2)
-02, -03	EP, -EP-A, -EP-A-P	PT-1-24-02-15	TP-03 (x 2)

**PROPRIETARY NOTE**  
 THIS DOCUMENT CONTAINS CONFIDENTIAL AND PROPRIETARY INFORMATION AND ALL DESIGN, MANUFACTURING, REPRODUCTION, USE, PATENT RIGHTS AND SALES RIGHTS ARE EXPRESSLY RESERVED BY SAMTEC, INC. THIS DOCUMENT SHALL NOT BE DISCLOSED, IN WHOLE OR PART, TO ANY UNAUTHORIZED PERSON OR ENTITY NOR REPRODUCED, TRANSFERRED OR INCORPORATED IN ANY OTHER PROJECT IN ANY MANNER WITHOUT THE EXPRESS WRITTEN CONSENT OF SAMTEC, INC.

DO NOT SCALE DRAWING

SHEET SCALE: 5:1

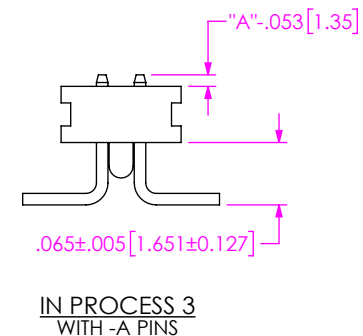
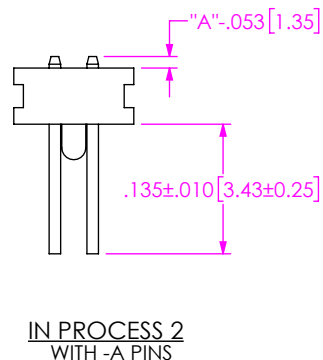
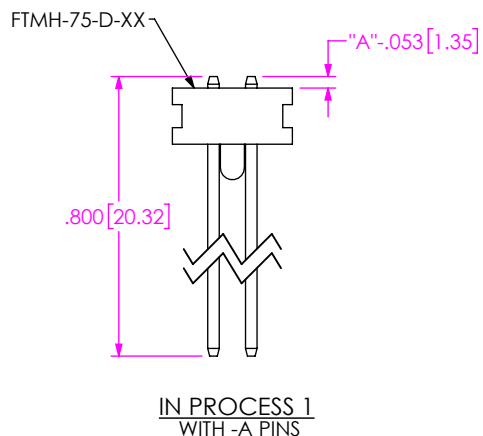
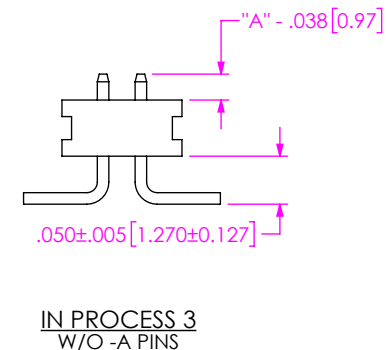
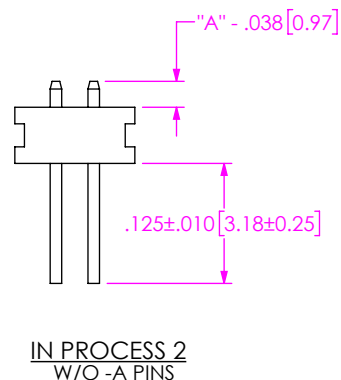
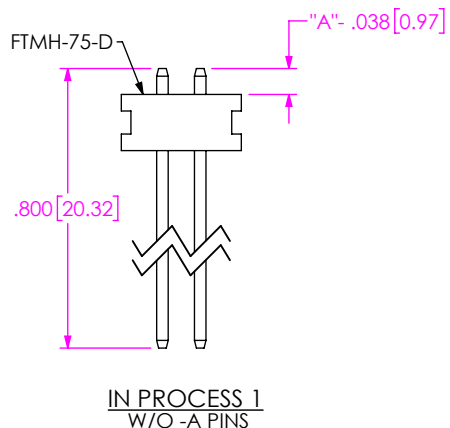


520 PARK EAST BLVD, NEW ALBANY, IN 47150  
 PHONE: 812-944-6733 FAX: 812-948-5047  
 e-Mail: info@SAMTEC.com code: 55322

DESCRIPTION:  
 1mm x 1mm DOUBLE VERTICAL SMT TERMINAL STRIP

DWG. NO.  
**FTMH-1XX-XX-XX-DV-XX-X-XX**

BY: PURVIS 04/22/96 SHEET 5 OF 6



**PROPRIETARY NOTE**

THIS DOCUMENT CONTAINS CONFIDENTIAL AND PROPRIETARY INFORMATION AND ALL DESIGN, MANUFACTURING, REPRODUCTION, USE, PATENT RIGHTS AND SALES RIGHTS ARE EXPRESSLY RESERVED BY SAMTEC, INC. THIS DOCUMENT SHALL NOT BE DISCLOSED, IN WHOLE OR PART, TO ANY UNAUTHORIZED PERSON OR ENTITY NOR REPRODUCED, TRANSFERRED OR INCORPORATED IN ANY OTHER PROJECT IN ANY MANNER WITHOUT THE EXPRESS WRITTEN CONSENT OF SAMTEC, INC.

**samtec**

520 PARK EAST BLVD, NEW ALBANY, IN 47150  
PHONE: 812-944-6733 FAX: 812-948-5047  
e-Mail: info@SAMTEC.com code: 55322

DO NOT SCALE DRAWING

SHEET SCALE: 5:1

DESCRIPTION:  
1mm x 1mm DOUBLE VERTICAL SMT TERMINAL STRIP

DWG. NO.  
FTMH-1XX-XX-XX-DV-XX-X-XX

BY: PURVIS 04/22/96 SHEET 6 OF 6