

DO NOT SCALE FROM THIS PRINT

DESIGNED & DIMENSIONED IN MILLIMETERS [INCHES]

MCP-8-02-X-XX.XX-X-XX

PLUG
SIZE
LEAD STYLE
-02: 12 POS, 28 AWG
PLATING SPECIFICATION
-L: 10µ" GOLD IN CONTACT AREA

END 2
-T: TERMINAL
-S: SOCKET
-BC: BLUNT CUT

END 1
-T: TERMINAL
-S: SOCKET (NOT AVAILABLE WITH END 2 -T)

ASSEMBLED LENGTH
XX.XX (IN METERS)
(0.25 METER MIN TO 50.00 METER MAX)

FIG 1
MCP-8-02-X-XX.XX-T-S SHOWN

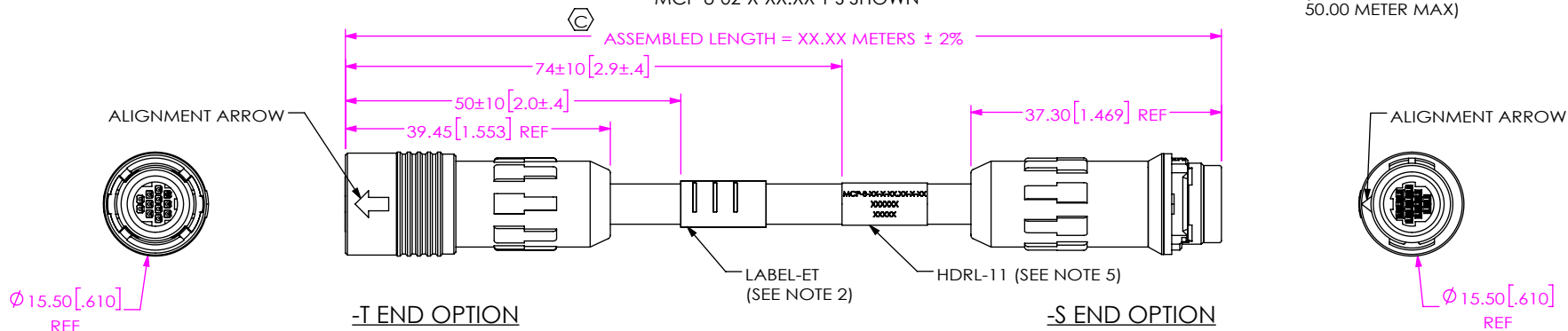

END OPTIONS

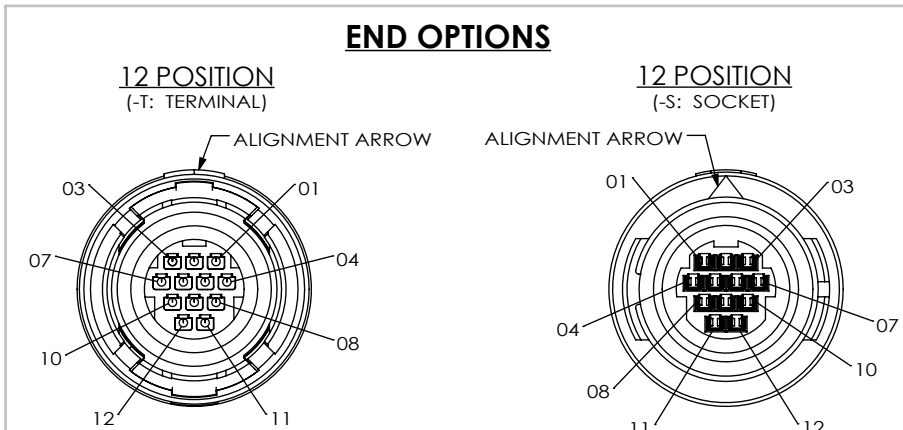
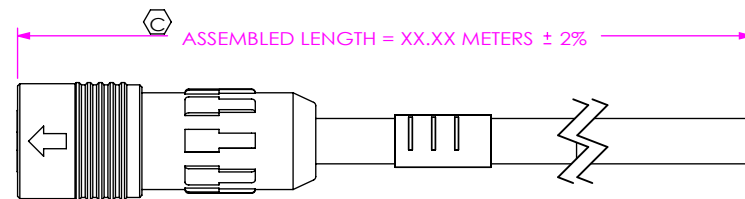

FIG 2
MCP-8-02-X-XX.XX-T-BC SHOWN
(BUILT DOUBLE ENDED INITIALLY FOR E-TEST)



NOTES:

- ⊕ REPRESENTS A CRITICAL DIMENSION.
- ASSEMBLY TO BE 100% TESTED FOR CONTINUITY, ISOLATION, & HI-POT AT 300V.
(1) LABEL-ET TO BE APPLIED AFTER FINAL ELECTRICAL TEST.
- FOLLOW PACKAGING MANUAL INSTRUCTIONS.
- SIGNAL MAPPING IS 1 TO 1, 2 TO 2, 3 TO 3, ETC..
- PLACE HDRL-11 (LABEL) ON CABLE WHERE SHOWN. LABEL TO CONTAIN
LINE 1 - PART NUMBER "MCP-8-XX-X-XX.XX-X-XX"
LINE 2 - SHOP ORDER NUMBER "XXXXXX"
LINE 3 - DATE CODE "XXXXX"
- CONTACTS/TERMINALS MUST BE INSERTED UNTIL RETENTION FEATURE LOCKS INTO PLACE.
- REFER TO CRIMP-SPECIFICATIONS PRINT FOR CRIMP AND STRIP DIMENSIONS, TOLERANCES, TOOLING, AND ITS REQUIREMENTS.
- T (TERMINAL): REFERENCE DC-MCP-8 PRINT FOR TERMINAL DUSTCAP
-S (SOCKET): REFERENCE DC-MCR-8 PRINT FOR SOCKET DUSTCAP
- APPLY EPOXY-40 (LOCTITE 7649) TO THE THREADS AND ALLOW TO DRY FOR 60 SECONDS.
- APPLY EPOXY-41 (LOCTITE 271) TO THE THREADS.
- O-RING MUST BE SEATED AGAINST CH-P-30-8-12.

UNLESS OTHERWISE SPECIFIED, DIMENSIONS ARE IN MILLIMETERS.
TOLERANCES ARE:
DECIMALS ANGLES
X.X: ±0.3 [.01]
X.XX: ±0.13 [.005]
X.XXX: ±0.051 [.0020]

PROPRIETARY NOTE
THIS DOCUMENT CONTAINS CONFIDENTIAL AND PROPRIETARY INFORMATION AND ALL DESIGN, MANUFACTURING, REPRODUCTION, USE, PATENT RIGHTS AND SALES RIGHTS ARE EXPRESSLY RESERVED BY SAMTEC, INC. THIS DOCUMENT SHALL NOT BE DISCLOSED, IN WHOLE OR PART, TO ANY UNAUTHORIZED PERSON OR ENTITY NOR REPRODUCED, TRANSFERRED OR INCORPORATED IN ANY OTHER PROJECT IN ANY MANNER WITHOUT THE EXPRESS WRITTEN CONSENT OF SAMTEC, INC.

MATERIAL: DO NOT SCALE DRAWING
INSULATORS, CABLE NUT, C-RING: PPS
TERMINALS & CONTACTS: PHOS BRONZE
GASKET, O-RING: SILICONE
SPRING: STAINLESS STEEL
COUPLING RING, SPACER: PBT
CABLE CLAMP: POM

SHEET SCALE: 1:1

samtec

520 PARK EAST BLVD. NEW ALBANY, IN 47150
PHONE: 812-944-6733 FAX: 812-948-5047
e-Mail info@SAMTEC.com code 55322

DESCRIPTION:
MINI CIRC. CABLE ASSEMBLY

DWG. NO.
MCP-8-02-X-XX.XX-X-XX

BY: J. BORGELT 2/15/13 SHEET 1 OF 3

IN-PROCESS 1

CUT CABLE TO LENGTH SHOWN BASED ON END 1 & 2 GENDER
 (-BC FORMULA LENGTHS ADJUSTED TO INITIALLY BUILD CABLES DOUBLE ENDED)

- ⊕ CABLE LENGTH (-T-T) = (XX.XX METERS - 0.02 METERS) ± 2%
- ⊕ CABLE LENGTH (-S-S) = (XX.XX METERS - 0.017 METERS) ± 2%
- ⊕ CABLE LENGTH (-T-S) = (XX.XX METERS - 0.021 METERS) ± 2%
- ⊕ CABLE LENGTH (-T-BC) = ((XX.XX METERS X 2) + 0.027 METERS) ± 2%
- ⊕ CABLE LENGTH (-S-BC) = ((XX.XX METERS X 2) + 0.033 METERS) ± 2%

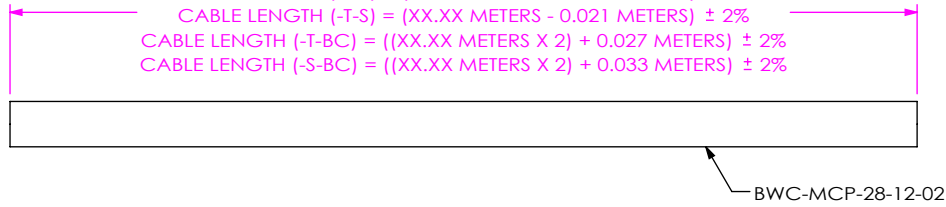

IN-PROCESS 2
 STRIP OUTER JACKET

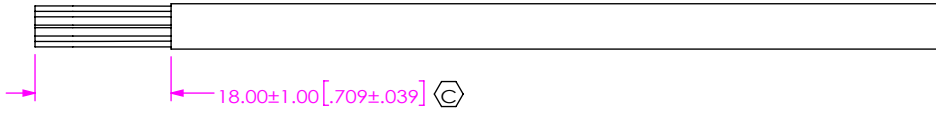

-T (TERMINAL): IN-PROCESS 3
 STRIP INDIVIDUAL WIRES & CRIMP TERMINALS
 (SEE NOTE 7)

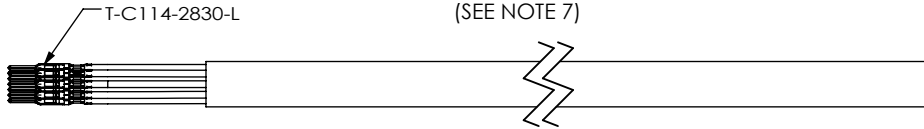

-T (TERMINAL): IN-PROCESS 4

APPLY EPOXY-40 (LOCTITE 7649) TO THE INTERNAL THREADS OF CN-30-8 (SEE NOTE 9).
 THEN SLIDE COMPONENTS ONTO CABLE IN ORDER SHOWN

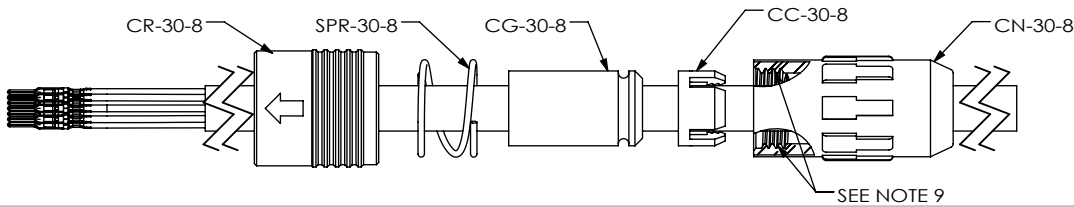

-T (TERMINAL): IN-PROCESS 5

INSERT TERMINALS INTO CH-P-30-8-12 INSULATOR
 UNTIL THEIR RETENTION FEATURES LOCK INTO PLACE.
 SEE TABLE 1 FOR COLOR MAPPING.

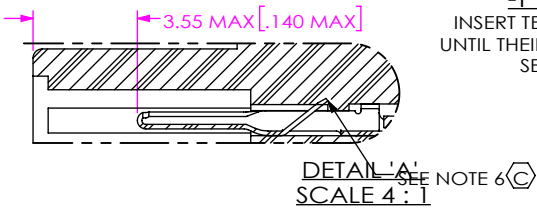

DETAIL 'A'
 SCALE 4:1

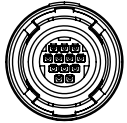
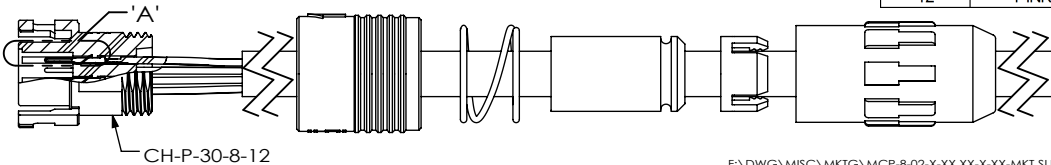

-T (TERMINAL): IN-PROCESS 6

ADD OR-30-8 AND APPLY EPOXY-40 (LOCTITE 7649)
 TO THE THREADS OF CH-P-30-8-12 (SEE NOTE 9)

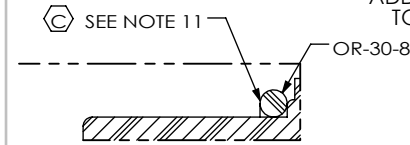

DETAIL 'B'
 SCALE 4:1

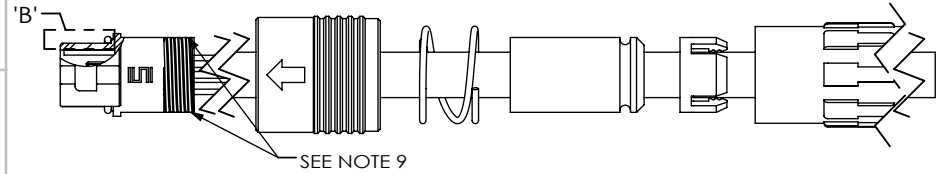

-T (TERMINAL): IN-PROCESS 7
 WHILE ALIGNING ORIENTATION FEATURES
 SLIDE CR-30-8 ONTO CH-P-30-8-12

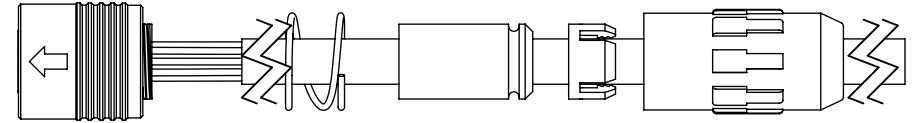

-T (TERMINAL): IN-PROCESS 8
 SLIDE SPR-30-8 INTO CR-30-8.
 THEN SLIDE CG-30-8 UNTIL IT SEATS AGAINST THE BACK OF CH-P-30-8-12.
 THEN SLIDE CC-30-8 IN UNTIL IT SEATS AGAINST THE BACK OF CG-30-8.

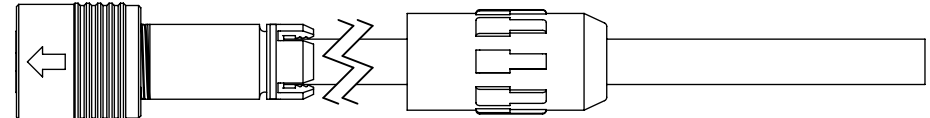

-T (TERMINAL): IN-PROCESS 9

APPLY EPOXY-41 (LOCTITE 271) TO THREADS OF CN-30-8 (SEE NOTE 10). THEN
 THREAD CN-30-8 ON TO THE CH-P-30-8-12 & TORQUE TO 0.5 Nm [4.4 IN-LBS].

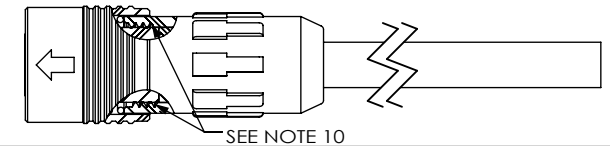

TABLE 1	
POSITION	COLOR
01	BROWN
02	RED
03	ORANGE
04	YELLOW
05	GREEN
06	BLUE
07	VIOLET
08	GRAY
09	WHITE
10	BLACK
11	LIGHT BLUE
12	PINK

PROPRIETARY NOTE

THIS DOCUMENT CONTAINS CONFIDENTIAL AND PROPRIETARY INFORMATION AND ALL DESIGN, MANUFACTURING, REPRODUCTION, USE, PATENT RIGHTS AND SALES RIGHTS ARE EXPRESSLY RESERVED BY SAMTEC, INC. THIS DOCUMENT SHALL NOT BE DISCLOSED, IN WHOLE OR PART, TO ANY UNAUTHORIZED PERSON OR ENTITY NOR REPRODUCED, TRANSFERRED OR INCORPORATED IN ANY OTHER PROJECT IN ANY MANNER WITHOUT THE EXPRESS WRITTEN CONSENT OF SAMTEC, INC.

DO NOT SCALE DRAWING

SHEET SCALE: 1:1



520 PARK EAST BLVD, NEW ALBANY, IN 47150
 PHONE: 812-944-6733 FAX: 812-948-5047
 e-Mail info@SAMTEC.com code 55322

DESCRIPTION:	MINI CIRC. CABLE ASSEMBLY
DWG. NO.	MCP-8-02-X-XX.XX-X-XX
BY:	J. BORGELT 2/15/13 SHEET 2 OF 3

-S (SOCKET): IN-PROCESS 3
 STRIP INDIVIDUAL WIRES & CRIMP CONTACT
 (SEE NOTE 7)

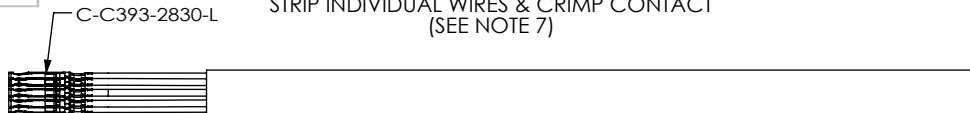

-S (SOCKET): IN-PROCESS 4

APPLY EPOXY-40 (LOCTITE 7649) TO THE THREADS OF CN-30-8 (SEE NOTE 9)
 SLIDE COMPONENTS ONTO CABLE IN ORDER SHOWN

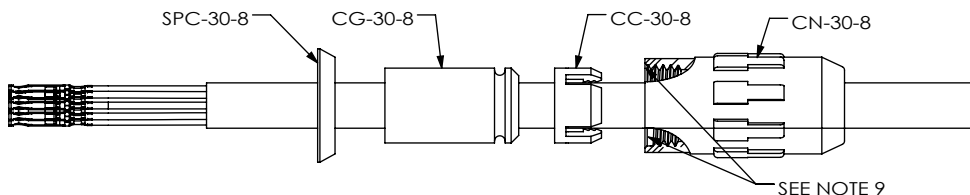

-S (SOCKET): IN-PROCESS 5

APPLY EPOXY-40 (LOCTITE 7649) TO THE THREADS OF SUB-MCR-8-12.
 INSERT CONTACTS INTO SUB-MCR-8-12 INSULATOR
 UNTIL THEIR RETENTION BEAMS ENGAGE.
 SEE TABLE 2 FOR COLOR MAPPING.
 (SEE NOTE 9)

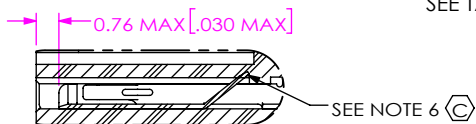

DETAIL 'C'
 SCALE 4 : 1

TABLE 2	
POSITION	COLOR
01	BROWN
02	RED
03	ORANGE
04	YELLOW
05	GREEN
06	BLUE
07	VIOLET
08	GRAY
09	WHITE
10	BLACK
11	LIGHT BLUE
12	PINK

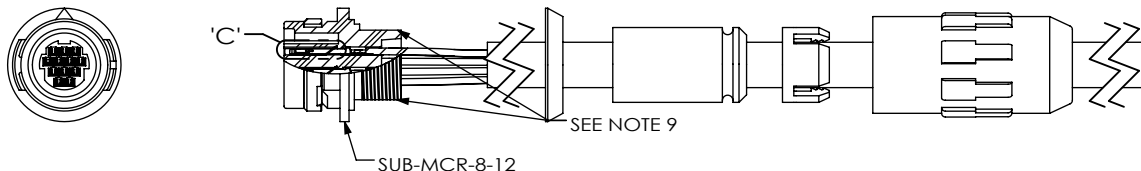

-S (SOCKET): IN-PROCESS 6

SLIDE SPC-30-8 ONTO SUB-MCR-8-12.
 THEN SLIDE CG-30-8 UNTIL IT SEATS AGAINST THE BACK OF SUB-MCR-8-12.
 THEN SLIDE CC-30-8 UNTIL IT SEATS AGAINST THE BACK OF CG-30-8.

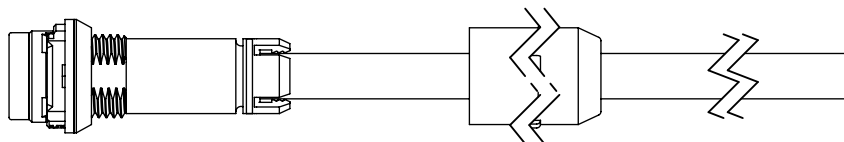

-S (SOCKET): IN-PROCESS 7

APPLY EPOXY-41 (LOCTITE 271)
 TO THE THREADS OF SUB-MCR-8-12. (SEE NOTE 10)

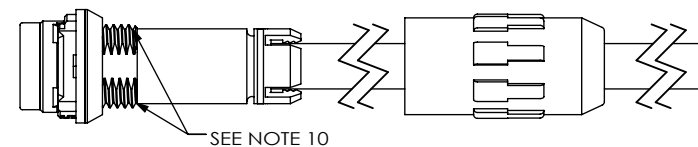

-S (SOCKET): IN-PROCESS 8

THREAD CN-30-8 ON TO SUB-MCR-8-12 & TORQUE TO 0.5 Nm [4.4 IN-LBS].

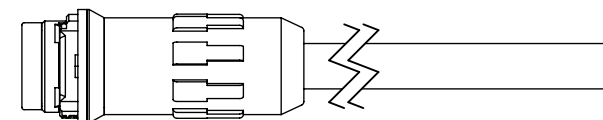

PROPRIETARY NOTE

THIS DOCUMENT CONTAINS CONFIDENTIAL AND PROPRIETARY INFORMATION AND ALL DESIGN, MANUFACTURING, REPRODUCTION, USE, PATENT RIGHTS AND SALES RIGHTS ARE EXPRESSLY RESERVED BY SAMTEC, INC. THIS DOCUMENT SHALL NOT BE DISCLOSED, IN WHOLE OR PART, TO ANY UNAUTHORIZED PERSON OR ENTITY NOR REPRODUCED, TRANSFERRED OR INCORPORATED IN ANY OTHER PROJECT IN ANY MANNER WITHOUT THE EXPRESS WRITTEN CONSENT OF SAMTEC, INC.

DO NOT SCALE DRAWING

SHEET SCALE: 1:1



520 PARK EAST BLVD, NEW ALBANY, IN 47150
 PHONE: 812-944-6733 FAX: 812-948-5047
 e-Mail: info@SAMTEC.com code 55322

DESCRIPTION: MINI CIRC. CABLE ASSEMBLY

DWG. NO. MCP-8-02-X-XX.XX-X-XX

BY: J. BORGELT 2/15/13 SHEET 3 OF 3