

## MSCDC200A120D1PAG Phase leg SiC diodes Power Module

### 1 Product Overview

This section shows the product overview for the MSCDC200A120D1PAG device.

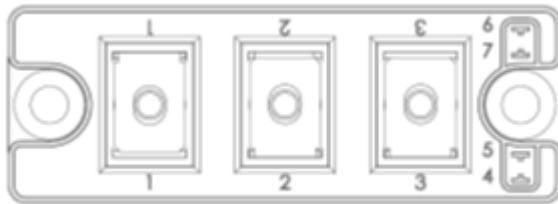
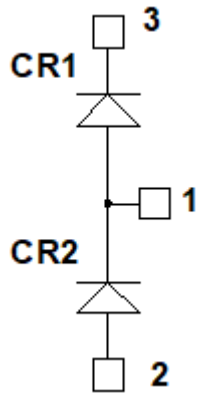

All ratings at  $T_j = 25^\circ\text{C}$ , unless otherwise specified.

**Caution:** These devices are sensitive to electrostatic discharge. Proper handling procedures should be followed.

## 1.1 Features

The following are key features of the MSCDC200A120D1PAG device:

- Silicon Carbide (SiC) Schottky Diode
  - Zero reverse recovery
  - Zero forward recovery
  - Temperature independent switching behavior
  - Positive temperature coefficient on VF
- M5 power connectors
- Aluminum nitride (AlN) substrate for improved thermal performance

## 1.2 Benefits

The following are benefits of the MSCDC200A120D1PAG device:

- Stable temperature behavior
- Low losses
- Direct mounting to heatsink (isolated package)
- Low junction-to-case thermal resistance
- RoHS compliant

## 1.3 Applications

The MSCDC200A120D1PAG device is designed for the following applications:

- Uninterruptible power supply (UPS)
- Switched mode power supply
- Welding converters
- Motor control

## 2 Electrical Specifications

This section shows the electrical specifications for the MSCDC200A120D1PAG device.

### 2.1 Absolute Maximum Ratings

The following table shows the absolute maximum ratings per SiC diode for the MSCDC200A120D1PAG device.

**Table 1 • Absolute Maximum Ratings**

Symbol	Parameter	Maximum Ratings	Unit
$V_{RRM}$	Repetitive peak reverse voltage	1200	V
$I_F$	DC forward current	$T_C = 95\text{ }^\circ\text{C}$ 200	A

The following table shows the thermal and package characteristics of the MSCDC200A120D1PAG.

**Table 2 • Thermal and Package Characteristics**

Symbol	Characteristic	Min	Max	Unit		
$V_{ISOL}$	RMS isolation voltage, any terminal to case $t = 1$ minute, 50 Hz/60 Hz	4000		V		
$T_J$	Operating junction temperature range	-40	175	$^\circ\text{C}$		
$T_{JOP}$	Recommended junction temperature under switching conditions	-40	$T_{Jmax} - 25$			
$T_{STG}$	Storage temperature range	-40	125			
$T_C$	Operating case temperature	-40	125			
Torque	Mounting torque	To heatsink	M6	3	5	N.m
		For terminals	M5	2	3.5	
Wt	Package weight			160	g	

### 2.2 Electrical Performance

The following table shows the electrical characteristics per SiC diode of the MSCDC200A120D1PAG.

**Table 3 • Electrical Characteristics Per Diode**

Symbol	Characteristic	Test Conditions	Min	Typ	Max	Unit
$V_F$	Diode forward voltage	$I_F = 200\text{ A}$	$T_J = 25\text{ }^\circ\text{C}$	1.5	1.8	V
			$T_J = 175\text{ }^\circ\text{C}$	2.1		
$I_{RM}$	Reverse leakage current	$V_R = 1200\text{ V}$	$T_J = 25\text{ }^\circ\text{C}$	60	800	$\mu\text{A}$
			$T_J = 175\text{ }^\circ\text{C}$	1000		
$Q_C$	Total capacitive charge	$V_R = 600\text{ V}$		896		nC
C	Total capacitance	$f = 1\text{ MHz}, V_R = 400\text{ V}$		984		pF
		$f = 1\text{ MHz}, V_R = 800\text{ V}$		728		
$R_{thJC}$	Junction-to-case thermal resistance				0.16	$^\circ\text{C/W}$

## 2.3 Performance Curves

This section shows the typical performance curves for the MSCDC200A120D1PAG device.

Figure 1 • Maximum Transient Thermal Impedance

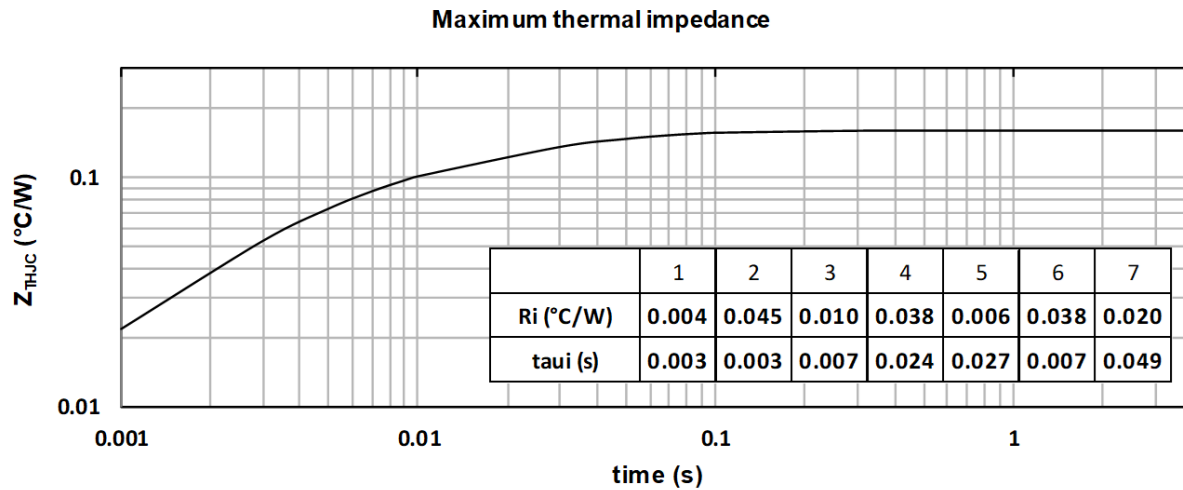

Figure 2 • Forward Current vs Forward Voltage

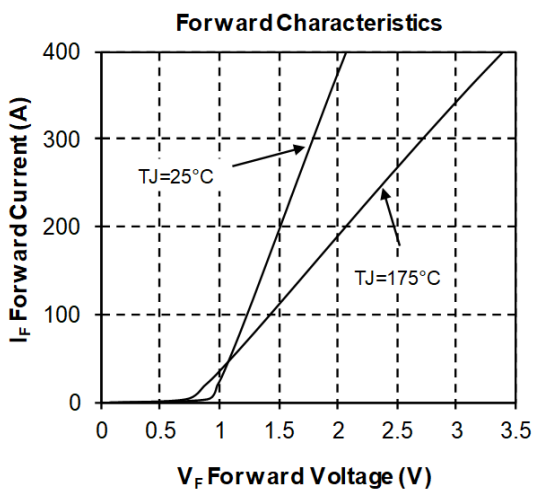
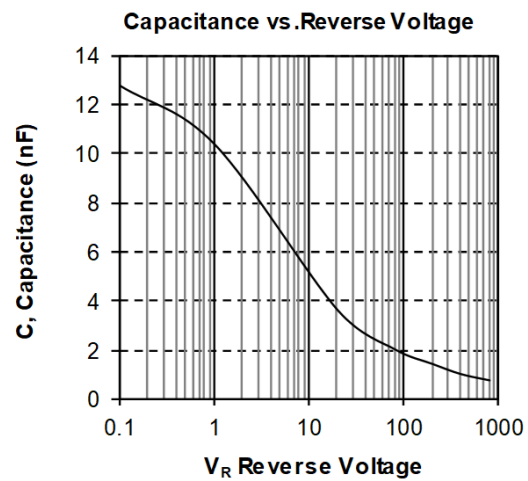

Figure 3 • Capacitance vs. Reverse Voltage



### 3 Package Specifications

This section shows the package specifications for the MSCDC200A120D1PAG device.

#### 3.1 Package Outline Drawing

This section shows the package outline drawing of the MSCDC200A120D1PAG device. The dimensions in the following figure are in millimeters.

**Figure 4 • Package Outline Drawing**

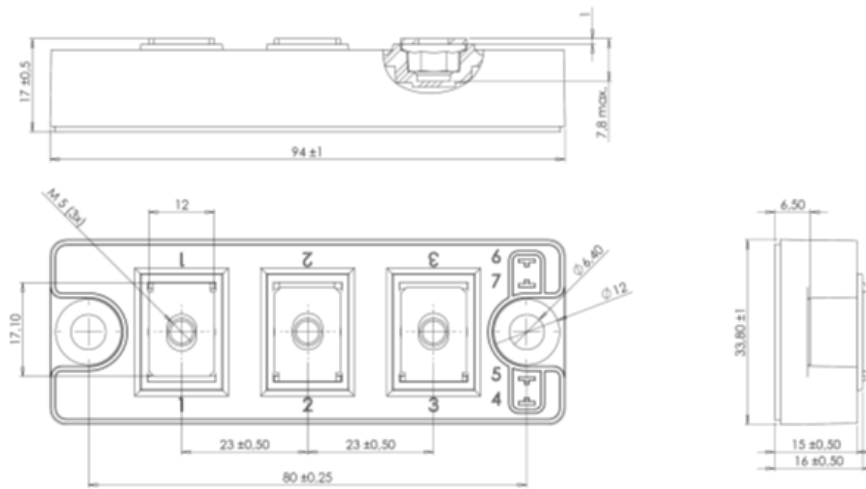

**Microsemi Headquarters**

One Enterprise, Aliso Viejo,  
CA 92656 USA  
Within the USA: +1 (800) 713-4113  
Outside the USA: +1 (949) 380-6100  
Sales: +1 (949) 380-6136  
Fax: +1 (949) 215-4996  
Email: [sales.support@microsemi.com](mailto:sales.support@microsemi.com)  
[www.microsemi.com](http://www.microsemi.com)

© 2019 Microsemi. All rights reserved. Microsemi and the Microsemi logo are trademarks of Microsemi Corporation. All other trademarks and service marks are the property of their respective owners.

Microsemi makes no warranty, representation, or guarantee regarding the information contained herein or the suitability of its products and services for any particular purpose, nor does Microsemi assume any liability whatsoever arising out of the application or use of any product or circuit. The products sold hereunder and any other products sold by Microsemi have been subject to limited testing and should not be used in conjunction with mission-critical equipment or applications. Any performance specifications are believed to be reliable but are not verified, and Buyer must conduct and complete all performance and other testing of the products, alone and together with, or installed in, any end-products. Buyer shall not rely on any data and performance specifications or parameters provided by Microsemi. It is the Buyer's responsibility to independently determine suitability of any products and to test and verify the same. The information provided by Microsemi hereunder is provided "as is, where is" and with all faults, and the entire risk associated with such information is entirely with the Buyer. Microsemi does not grant, explicitly or implicitly, to any party any patent rights, licenses, or any other IP rights, whether with regard to such information itself or anything described by such information. Information provided in this document is proprietary to Microsemi, and Microsemi reserves the right to make any changes to the information in this document or to any products and services at any time without notice.

Microsemi, a wholly owned subsidiary of Microchip Technology Inc. (Nasdaq: MCHP), offers a comprehensive portfolio of semiconductor and system solutions for aerospace & defense, communications, data center and industrial markets. Products include high-performance and radiation-hardened analog mixed-signal integrated circuits, FPGAs, SoCs and ASICs; power management products; timing and synchronization devices and precise time solutions, setting the world's standard for time; voice processing devices; RF solutions; discrete components; enterprise storage and communication solutions; security technologies and scalable anti-tamper products; Ethernet solutions; Power-over-Ethernet ICs and midspans; as well as custom design capabilities and services. Microsemi is headquartered in Aliso Viejo, California, and has approximately 4,800 employees globally. Learn more at [www.microsemi.com](http://www.microsemi.com).

MSCC-0344-DS-01007-1.0-0619 | June 2019 | Final