

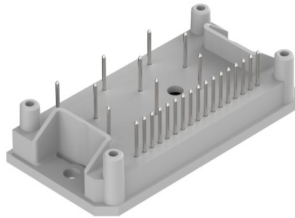
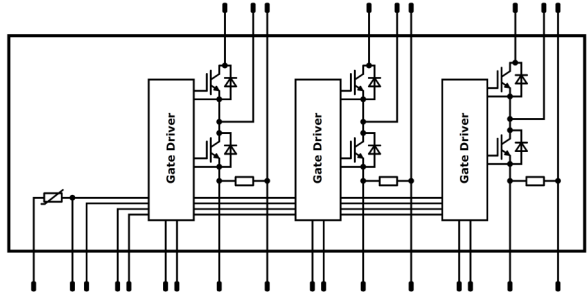

Vincotech

<i>flowIPM 1B</i>	1200 V / 15 A
<div style="background-color: #eee; padding: 2px; margin-bottom: 5px;">Features</div> <p>Power</p> <ul style="list-style-type: none"> • Three Phase Inverter • Emitter Shunts <p>Gate Driver</p> <ul style="list-style-type: none"> • Booststrap circuit • Overcurrent protection • Undervoltage lockout <p>NTC</p> <ul style="list-style-type: none"> • Temperature sensor 	<div style="background-color: #eee; padding: 2px; margin-bottom: 5px;">flow1B 17 mm housing</div> 
<div style="background-color: #eee; padding: 2px; margin-bottom: 5px;">Target applications</div> <ul style="list-style-type: none"> • Embedded Drives • Industrial Drives 	<div style="background-color: #eee; padding: 2px; margin-bottom: 5px;">Schematic</div> 
<div style="background-color: #eee; padding: 2px; margin-bottom: 5px;">Types</div> <ul style="list-style-type: none"> • 20-1B12IPA015SC-L579F09 	

Maximum Ratings

$T_j = 25\text{ °C}$, unless otherwise specified

Parameter	Symbol	Condition	Value	Unit
Inverter Switch				
Collector-emitter voltage	V_{CES}		1200	V
Collector current	I_C	$T_j = T_{jmax}$ $T_s = 80\text{ °C}$	12	A
Repetitive peak collector current	I_{CRM}	t_p limited by T_{jmax}	45	A
Total power dissipation	P_{tot}	$T_j = T_{jmax}$ $T_s = 80\text{ °C}$	31	W
Gate-emitter voltage	V_{GES}		± 20	V
Short circuit ratings	t_{SC}	$V_{GE} = 15\text{ V}$ $V_{CE} = 800\text{ V}$ $T_j \leq 150\text{ °C}$	10	μs
Maximum junction temperature	T_{jmax}		175	°C



Vincotech

Maximum Ratings

$T_j = 25\text{ °C}$, unless otherwise specified

Parameter	Symbol	Condition	Value	Unit
Inverter Diode				
Peak repetitive reverse voltage	V_{RRM}		1200	V
Continuous (direct) forward current	I_F	$T_j = T_{jmax}$ $T_s = 80\text{ °C}$	11	A
Repetitive peak forward current	I_{FRM}		30	A
Total power dissipation	P_{tot}	$T_j = T_{jmax}$ $T_s = 80\text{ °C}$	19	W
Maximum junction temperature	T_{jmax}		175	°C

Gate Driver

Supply voltage	V_{CC}		-0,5...+24	V
Logic input voltage	V_{in}	UH, UL, VH, VL, WH, WL, FO, RST	-0,5... $V_{cc}+0,5$	V
Internal current limit	I_{MAX}		16,7	A
Junction Temperature	T_{jmax}		125	°C

Inverter Shunt

Max DC current	I_{MAX}	$T_c = 25\text{ °C}$	9	A
Power dissipation	P_{tot}	$T_c = 105\text{ °C}$	2,43	W

Module Properties

Thermal Properties

Storage temperature	T_{stg}		-40...+125	°C
Operation temperature under switching condition	T_{jop}		-40...($T_{jmax} - 25$)	°C

Isolation Properties

Isolation voltage	V_{isol}	DC Test Voltage* $t_p = 2\text{ s}$	6000	V
		AC Voltage $t_p = 1\text{ min}$	2500	V
Creepage distance			min. 12,7	mm
Clearance			min. 12,7	mm
Comparative Tracking Index	CTI		> 200	

*100 % tested in production



Vincotech

Characteristic Values

Parameter	Symbol	Conditions					Value			Unit
		V_{GE} [V] V_{GS} [V]	V_{CE} [V] V_{DS} [V] V_F [V]	I_C [A] I_D [A] I_F [A]	T_j [°C]	Min	Typ	Max		

Inverter Switch

Static

Gate-emitter threshold voltage	$V_{GE(th)}$	$V_{CE} = V_{CE}$			0,0005	25	5,3	5,8	6,3	V
Collector-emitter saturation voltage	V_{CEsat}		15		12	25 125 150		2,10 2,28 2,46	2,3	V
Collector-emitter cut-off current	I_{CES}		0	1200		25			10	μA
Gate-emitter leakage current	I_{GES}		20	0		25			120	nA
Internal gate resistance	r_g							none		Ω
Input capacitance	C_{ies}	$f = 1$ Mhz	0	25		25		890		pF
Reverse transfer capacitance	C_{res}							30		
Gate charge	Q_g		20			25		0,12		nC

Thermal

Thermal resistance junction to sink	$R_{th(j-s)}$	$\lambda_{paste} = 3,4$ W/mK (PSX)						3,07		K/W
-------------------------------------	---------------	---------------------------------------	--	--	--	--	--	------	--	-----

Dynamic

Turn-on delay time*	$t_{d(on)}$	$R_{gon} = 16$ Ω $R_{goff} = 32$ Ω	0 / 15	600	11	25		1480		ns
						125		1912		
						150		2007		
Rise time	t_r					25		19		
						125		23		
		150		24						
Turn-off delay time*	$t_{d(off)}$					25		1508		
						125		2011		
						150		2119		
Fall time	t_f					25		79		
						125		133		
						150		159		
Turn-on energy (per pulse)	E_{on}	$Q_{t-FWD} = 1,2$ μC $Q_{t-FWD} = 2,2$ μC $Q_{t-FWD} = 2,6$ μC				25		0,676		mWs
						125		1,107		
						150		1,240		
Turn-off energy (per pulse)	E_{off}					25		0,879		
						125		1,440		
						150		1,600		

* times include gate driver propagation delay



Vincotech

Characteristic Values

Parameter	Symbol	Conditions					Value			Unit
		V_{GE} [V]	V_{CE} [V]	I_C [A]	T_j [°C]	Min	Typ	Max		

Inverter Diode

Static

Parameter	Symbol	V_{GE} [V]	V_{CE} [V]	I_C [A]	T_j [°C]	Min	Typ	Max	Unit
Forward voltage	V_F			12	25 125 150		1,93 1,91 1,90	2,3	V
Reverse leakage current	I_R		1200		25			3,5	μA

Thermal

Parameter	Symbol	Conditions	Value	Unit
Thermal resistance junction to sink	$R_{th(j-s)}$	$\lambda_{paste} = 3,4$ W/mK (PSX)	4,92	K/W

Dynamic

Parameter	Symbol	V_{GE} [V]	V_{CE} [V]	I_C [A]	T_j [°C]	Min	Typ	Max	Unit
Peak recovery current	I_{RRM}				25 125 150		12 13 14		A
Reverse recovery time	t_{rr}				25 125 150		245 394 437		ns
Recovered charge	Q_r		0 / 15	600	11		1,226 2,228 2,557		μC
Reverse recovered energy	E_{rec}				25 125 150		0,453 0,829 0,965		mWs
Peak rate of fall of recovery current	$(di_{rr}/dt)_{max}$				25 125 150		80 42 39		A/μs



Vincotech

Characteristic Values

Parameter	Symbol	Conditions					Value			Unit
		V_{GE} [V]	V_{CE} [V]	I_C [A]	T_j [°C]	Min	Typ	Max		

Gate Driver*

Static

Recommended supply voltage	V_{CC}					13,5	15	20	V
Power on reset trip voltage	V_{FOR}					4,0	5,5	7,5	V
Internal current limit	I_{MAX}					13,3	16,7	20	A
Quiescent supply current	I_q						3	4,5	mA
Logic "1" input voltage	V_{IH}	UH, UL, VH, VL, WH, WL, RST				2,2	3	4	v
Logic "0" input voltage	V_{IL}		0,6	1,5	2,1	v			
Logic "1" input current	I_{inH}	$V_{in} = 5\text{ V}$				0,6	1	1,4	mA
Logic "0" input current	I_{inL}	$V_{in} = 0\text{ V}$				0	0	0,01	mA
Input signal filter time	t_{Filt}	UH, UL, VH, VL, WH, WL, FO (in), RST (pulse)				80	200	500	ns
Logic "1" FAULT output**	$V_{outFAULTH}$							0,95	V
Logic "1" FAULT input treshold voltage**	$V_{inFAULTH}$					0,6	1,5	2,1	V
Logic "0" FAULT input treshold voltage**	$V_{inFAULTL}$					2,2	3	4	V
Under voltage reset voltage	$V_{UVreset}$					10	10,8	11,6	V
Under voltage trip voltage	V_{UVtrip}					10,5	11,3	12,1	V
Under voltage hysteresis voltage	$V_{UVhysteresis}$					0,2	0,5	0,8	V
Under voltage filter time	t_{UVfilt}					4	8	16	μ s
Internal dead time	t_{UVfilt}	Delay matching, high side turn-on and low side turn off				-100	80	300	ns
Internal dead time	t_{UVfilt}	Delay matching, low side turn-on and high side turn off				-20	180	400	ns

* For more information see Mitsubishi's M81738FP datasheet. The recommended minimum input pulse width is 2.12 μ s.

** FAULT active low with pull up resistor to Vcc.

Inverter Shunt

Resistance	R						30		m Ω
------------	-----	--	--	--	--	--	----	--	------------



Vincotech

Characteristic Values

Parameter	Symbol	Conditions					Value			Unit
		V_{GE} [V] V_{GS} [V]	V_{CE} [V] V_{DS} [V] V_F [V]	I_C [A] I_D [A] I_F [A]	T_j [°C]	Min	Typ	Max		

Thermistor

Rated resistance	R				25		22		kΩ
Deviation of R_{100}	$\Delta_{R/R}$	$R_{100} = 1486 \Omega$			100	-12		+14	%
Power dissipation	P				25		200		mW
Power dissipation constant					25		2		mW/K
B-value	$B_{(25/50)}$	Tol. $\pm 3\%$			25		3950		K
B-value	$B_{(25/100)}$	Tol. $\pm 3\%$			25		3998		K
Vincotech NTC Reference								B	



Vincotech

Inverter Switch Characteristics

figure 1. IGBT

Typical output characteristics

$$I_C = f(V_{CE})$$

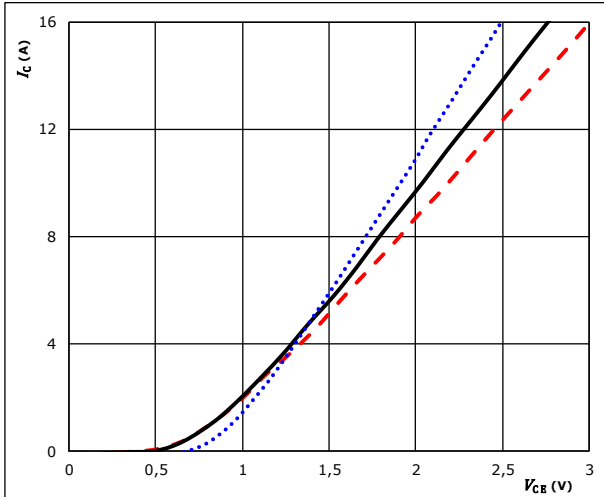

$t_p = 250 \mu s$ $T_j: 25 \text{ }^\circ C$ (dotted blue)
 $V_{GE} = 15 \text{ V}$ $T_j: 125 \text{ }^\circ C$ (solid black)
 $T_j: 150 \text{ }^\circ C$ (dashed red)

figure 2. IGBT

Typical output characteristics

$$I_C = f(V_{CE})$$

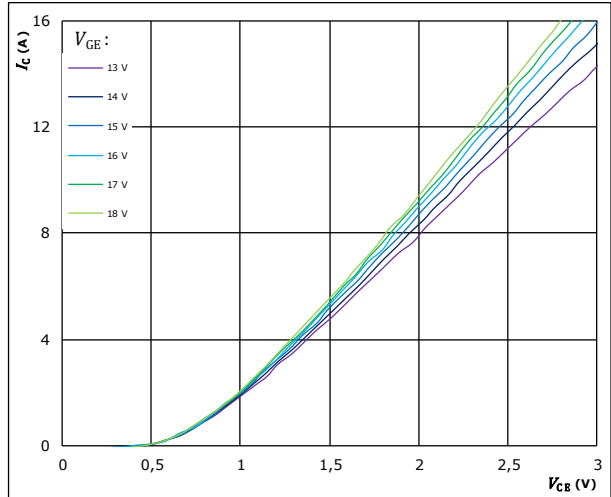

$t_p = 250 \mu s$
 $T_j = 150 \text{ }^\circ C$
 V_{GE} from 13 V to 18 V in steps of 1 V

figure 3. IGBT

Transient thermal impedance as function of pulse duration

$$Z_{th(j-s)} = f(t_p)$$

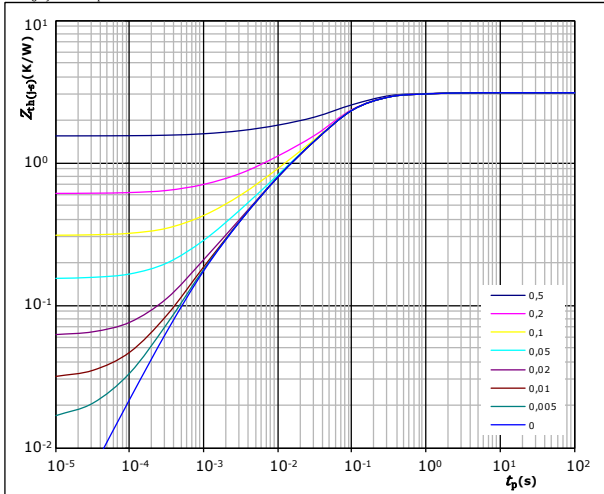

$D = t_p / T$
 $R_{th(j-s)} = 3,07 \text{ K/W}$
 IGBT thermal model values

R (K/W)	τ (s)
1,26E-01	1,14E+00
4,34E-01	2,04E-01
1,94E+00	6,00E-02
4,50E-01	6,48E-03
1,19E-01	9,59E-04

figure 4. IGBT

Safe operating area

$$I_C = f(V_{CE})$$

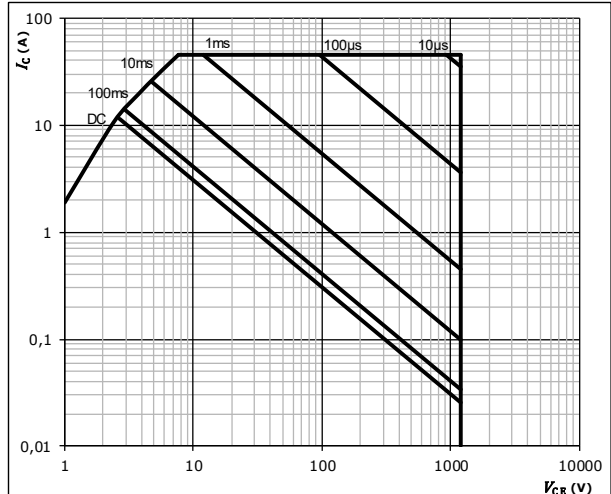

$D = \text{single pulse}$
 $T_s = 80 \text{ }^\circ C$
 $V_{GE} = \pm 15 \text{ V}$
 $T_j = T_{jmax}$



Inverter Diode Characteristics

figure 1. FWD

Typical forward characteristics

$$I_F = f(V_F)$$

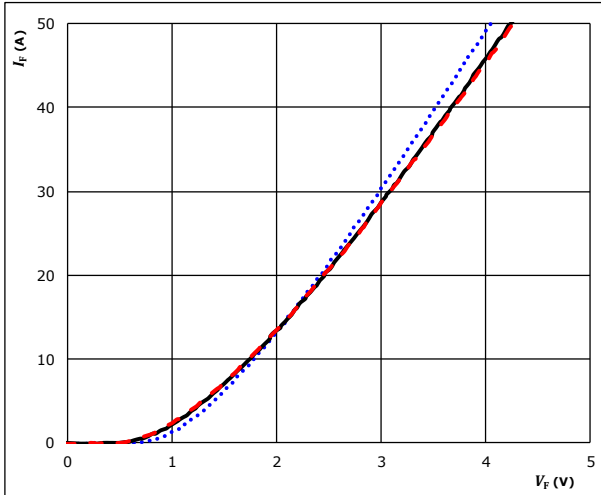

$t_p = 250 \mu s$
 T_j : 25 °C
 125 °C ———
 150 °C - - - -

figure 2. FWD

Transient thermal impedance as a function of pulse width

$$Z_{th(j-s)} = f(t_p)$$

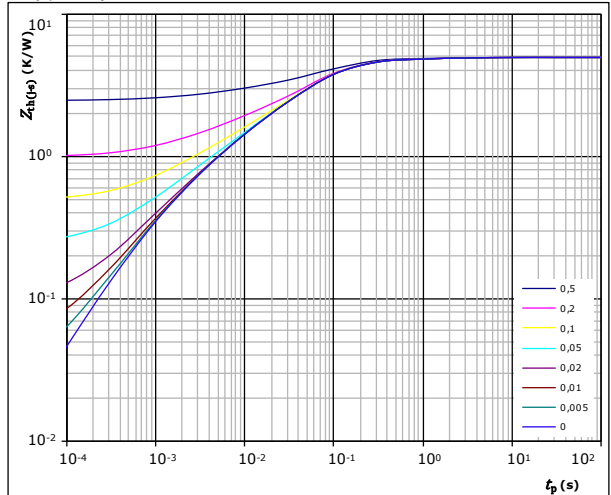

$D = t_p / T$
 $R_{th(j-s)} = 4,92 \text{ K/W}$
 FWD thermal model values

$R \text{ (K/W)}$	$\tau \text{ (s)}$
1,83E-01	2,10E+00
4,86E-01	2,84E-01
2,86E+00	6,82E-02
7,18E-01	1,40E-02
5,14E-01	3,30E-03
1,52E-01	6,79E-04

Thermistor Characteristics

figure 1. Thermistor

Typical NTC characteristic
as a function of temperature

$$R = f(T)$$

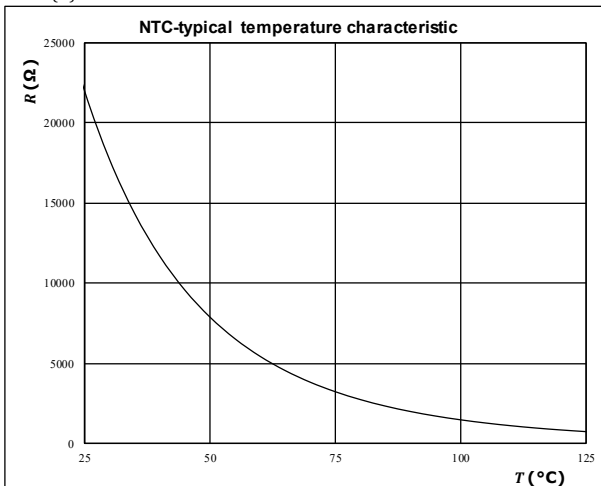



Inverter Switching Characteristics

figure 1. IGBT

Typical switching energy losses as a function of collector current

$$E = f(I_c)$$

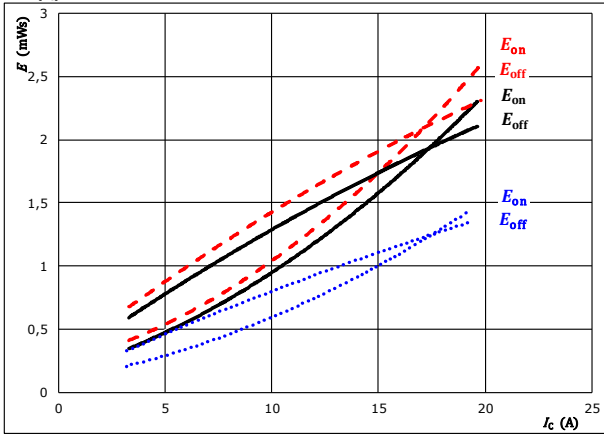

With an inductive load at
 $V_{CE} = 600$ V
 $V_{GE} = 0 / 15$ V
 $R_{gon} = 16$ Ω
 $R_{goff} = 32$ Ω
 $T_j = 25$ °C
 $T_j = 125$ °C
 $T_j = 150$ °C

figure 2. FWD

Typical reverse recovered energy loss as a function of collector current

$$E_{rec} = f(I_c)$$

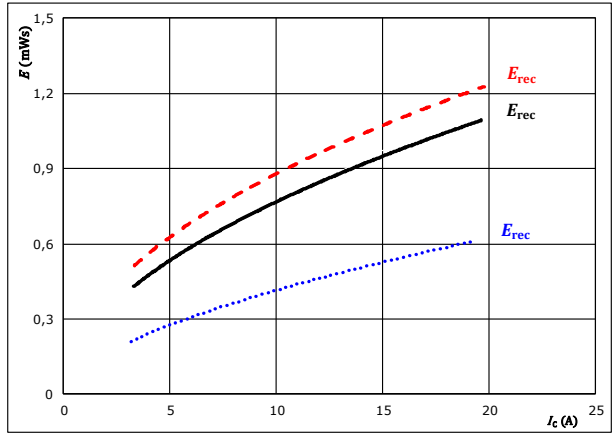

With an inductive load at
 $V_{CE} = 600$ V
 $V_{GE} = 0 / 15$ V
 $R_{gon} = 16$ Ω
 $T_j = 25$ °C
 $T_j = 125$ °C
 $T_j = 150$ °C

figure 3. IGBT

Typical switching times as a function of collector current

$$t = f(I_c)$$

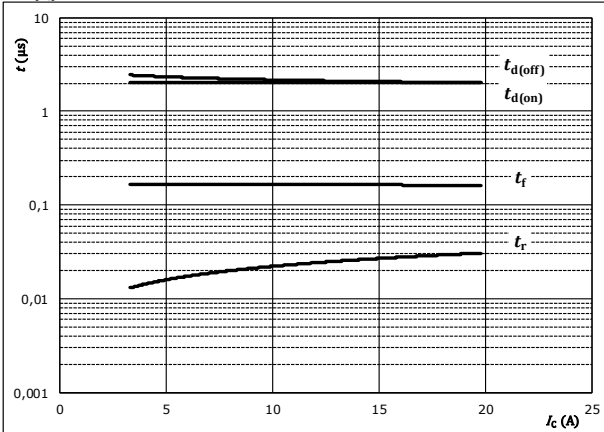

With an inductive load at
 $T_j = 150$ °C
 $V_{CE} = 600$ V
 $V_{GE} = 0 / 15$ V
 $R_{gon} = 16$ Ω
 $R_{goff} = 32$ Ω

figure 4. FWD

Typical reverse recovery time as a function of collector current

$$t_{rr} = f(I_c)$$

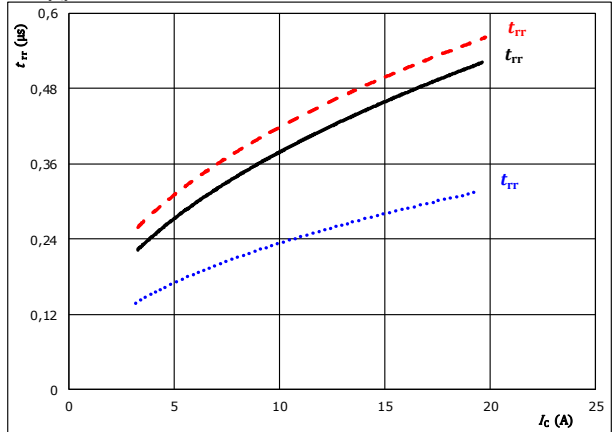

At
 $V_{CE} = 600$ V
 $V_{GE} = 0 / 15$ V
 $R_{gon} = 16$ Ω
 $T_j = 25$ °C
 $T_j = 125$ °C
 $T_j = 150$ °C



Inverter Switching Characteristics

figure 5. FWD

Typical recovered charge as a function of collector current

$$Q_r = f(I_c)$$

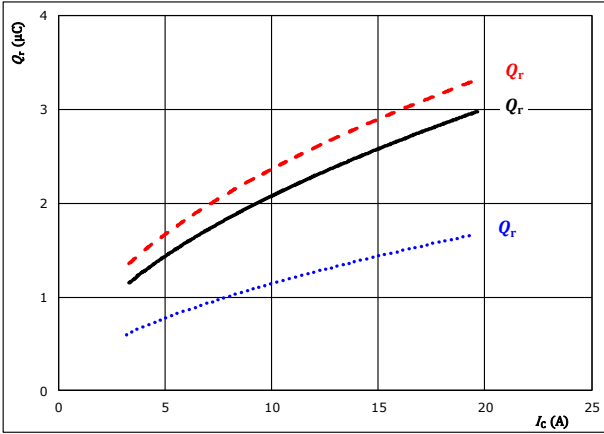

At $V_{CE} = 600$ V $T_j = 25$ °C $\dots\dots\dots$
 $V_{GE} = 0 / 15$ V $T_j = 125$ °C ---
 $R_{gpn} = 16$ Ω $T_j = 150$ °C ---

figure 6. FWD

Typical peak reverse recovery current current as a function of collector current

$$I_{RM} = f(I_c)$$

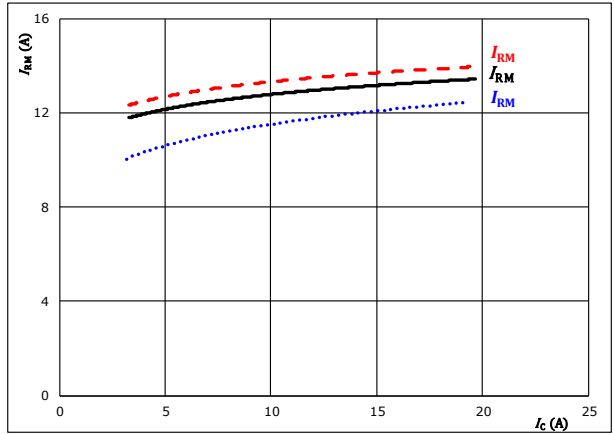

At $V_{CE} = 600$ V $T_j = 25$ °C $\dots\dots\dots$
 $V_{GE} = 0 / 15$ V $T_j = 125$ °C ---
 $R_{gpn} = 16$ Ω $T_j = 150$ °C ---

figure 7. FWD

Typical rate of fall of forward and reverse recovery current as a function of collector current

$$di_f/dt, di_{rr}/dt = f(I_c)$$

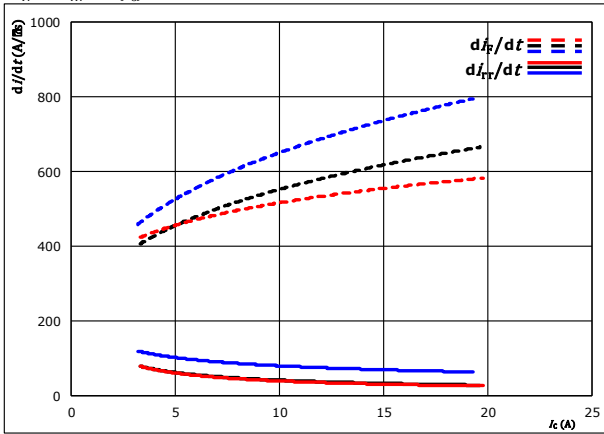

At $V_{CE} = 600$ V $T_j = 25$ °C $\dots\dots\dots$
 $V_{GE} = 0 / 15$ V $T_j = 125$ °C ---
 $R_{gpn} = 16$ Ω $T_j = 150$ °C ---

figure 7. IGBT

Reverse bias safe operating area

$$I_c = f(V_{CE})$$

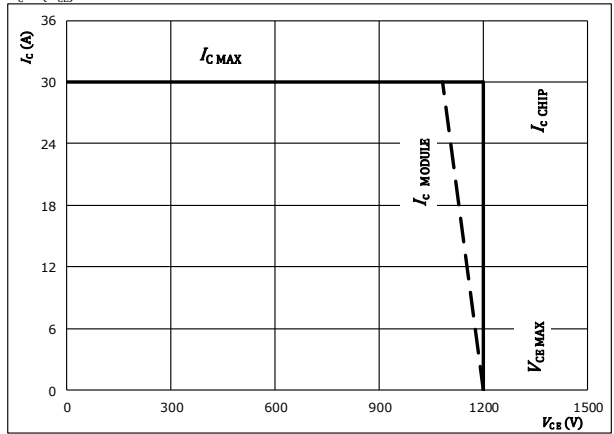

At $T_j = 175$ °C
 $R_{gpn} = 16$ Ω
 $R_{goff} = 32$ Ω



Inverter Switching Definitions

General conditions

T_j	=	125 °C
R_{gon}	=	16 Ω
R_{goff}	=	32 Ω

figure 1. IGBT

Turn-off Switching Waveforms & definition of t_{doff} , t_{Eoff} (t_{Eoff} = integrating time for E_{off})

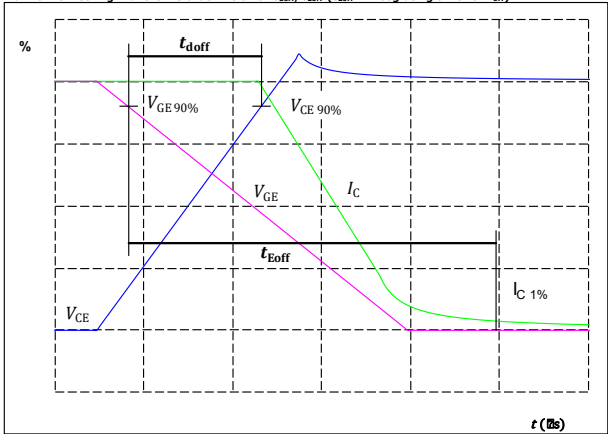

$V_{CE}(0\%) =$	0	V
$V_{GE}(100\%) =$	15	V
$V_C(100\%) =$	600	V
$I_C(100\%) =$	11	A
$t_{doff} =$	2011	ns

figure 2. IGBT

Turn-on Switching Waveforms & definition of t_{don} , t_{Eon} (t_{Eon} = integrating time for E_{on})

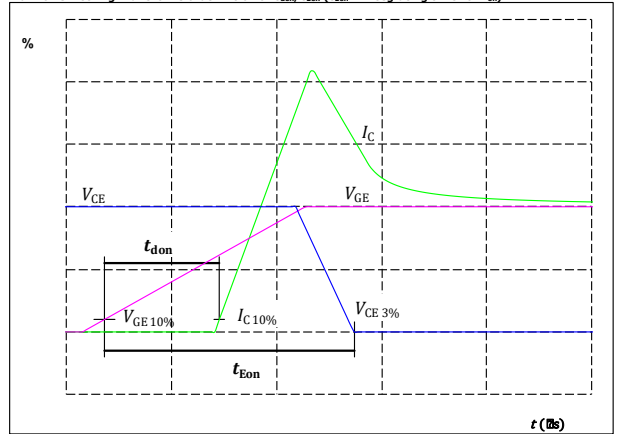

$V_{CE}(0\%) =$	0	V
$V_{GE}(100\%) =$	15	V
$V_C(100\%) =$	600	V
$I_C(100\%) =$	11	A
$t_{don} =$	1912	ns

figure 3. IGBT

Turn-off Switching Waveforms & definition of t_f

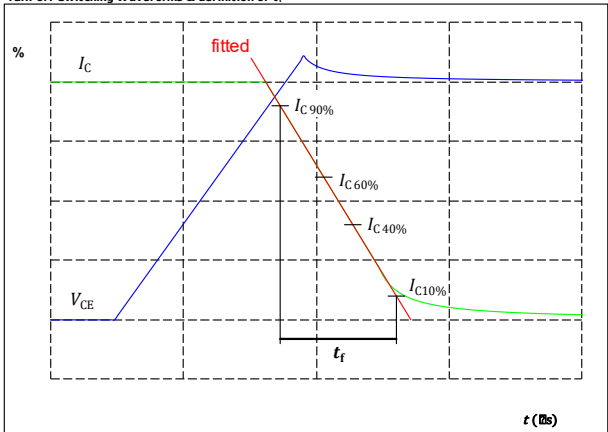

$V_C(100\%) =$	600	V
$I_C(100\%) =$	11	A
$t_f =$	133	ns

figure 4. IGBT

Turn-on Switching Waveforms & definition of t_r

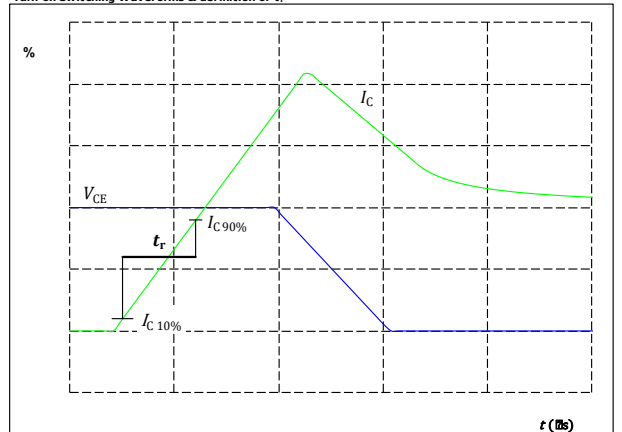

$V_C(100\%) =$	600	V
$I_C(100\%) =$	11	A
$t_r =$	23	ns



Vincotech

Inverter Switching Characteristics

figure 5. FWD

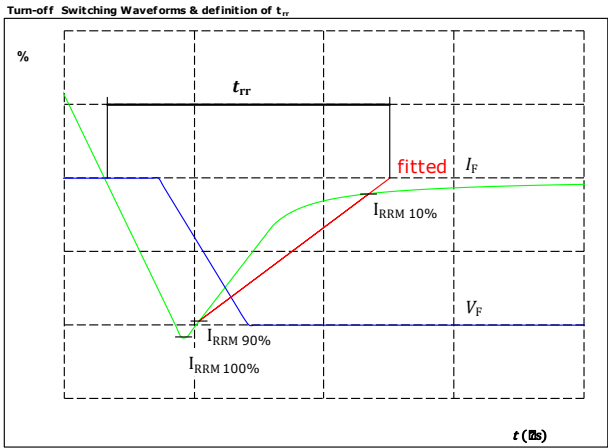

$V_F(100\%) =$	600	V
$I_F(100\%) =$	11	A
$I_{RRM}(100\%) =$	13	A
$t_{rr} =$	394	ns

figure 6. FWD

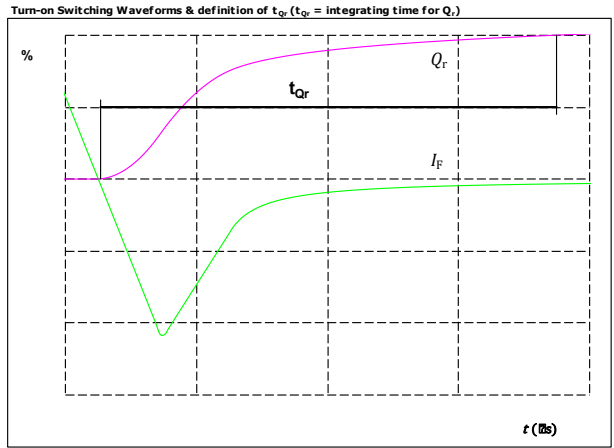

$I_F(100\%) =$	11	A
$Q_r(100\%) =$	2,23	μC



Vincotech

Ordering Code & Marking																																			
Version				Ordering Code																															
without thermal paste 17 mm housing with solder pins				20-1B12IPA015SC-L579F09																															
with thermal paste 17 mm housing with solder pins				20-1B12IPA015SC-L579F09-/3/																															
<table border="1"> <tr> <td rowspan="2"> NN-NNNNNNNNNNNNNN TTTTWTW WWYY UL VIN LLLL SSSS </td> <td rowspan="2"> </td> <td rowspan="2"> Text </td> <td colspan="2">Name</td> <td>Date code</td> <td>UL & VIN</td> <td>Lot</td> <td>Serial</td> </tr> <tr> <td> NN-NNNNNNNNNNNNNN-TTTTWTW </td> <td> WWYY </td> <td> UL VIN </td> <td> LLLLL </td> <td> SSSS </td> </tr> <tr> <td rowspan="2"> Datamatrix </td> <td rowspan="2"> </td> <td rowspan="2"> Name </td> <td>Type&Ver</td> <td>Lot number</td> <td>Serial</td> <td>Date code</td> <td></td> <td></td> </tr> <tr> <td> TTTTWTW </td> <td> LLLLL </td> <td> SSSS </td> <td> WWYY </td> <td></td> <td></td> </tr> </table>							NN-NNNNNNNNNNNNNN TTTTWTW WWYY UL VIN LLLL SSSS		Text	Name		Date code	UL & VIN	Lot	Serial	NN-NNNNNNNNNNNNNN-TTTTWTW	WWYY	UL VIN	LLLLL	SSSS	Datamatrix		Name	Type&Ver	Lot number	Serial	Date code			TTTTWTW	LLLLL	SSSS	WWYY		
NN-NNNNNNNNNNNNNN TTTTWTW WWYY UL VIN LLLL SSSS		Text	Name		Date code	UL & VIN				Lot	Serial																								
			NN-NNNNNNNNNNNNNN-TTTTWTW	WWYY	UL VIN	LLLLL	SSSS																												
Datamatrix		Name	Type&Ver	Lot number	Serial	Date code																													
			TTTTWTW	LLLLL	SSSS	WWYY																													

Pin table				Outline	
Pin	X	Y	Function		
1	45,1	0	WH		
2	42,4	0	WL		
3	39,7	0	RW+		
4	37	0	RW-		
5	34,3	0	GND		
6	31,6	0	VCC		
7	28,9	0	VH		
8	26,2	0	VL		
9	23,5	0	RV+		
10	20,8	0	RV-		
11	18,1	0	RST		
12	15,4	0	FO		
13	12,7	0	UH		
14	10	0	UL		
15	7,3	0	RU+		
16	4,6	0	RU-		
17	1,9	0	THERM1		
18	1,45	9,3	EU		
19	18,15	9,3	EV		
20	33,6	9,3	EW		
21	37,9	18,75	DC+3		
22	32,3	26,1	W		
23	22,35	19,35	DC+2		
24	16,15	26,1	V		
25	6,05	18,75	DC+1		
26	0	26,1	U		

Tolerance of pinpositions: ±0.5mm at the end of pins
Dimension of coordinate axis is only offset without tolerance

Pin Descriptions					
Pin	Function	Description	Pin	Function	Description
1	WH	Signal input for high-side W phase	18	EU	Open emitter U phase
2	WL	Signal input for low-side W phase	19	EV	Open emitter V phase
3	RW+	W phase shunt +	20	EW	Open emitter W phase
4	RW-	W phase shunt -	21	DC+3	Inverter input DC+
5	GND	Signal ground	22	W	Output W phase
6	VCC	Driver circuit supply voltage	23	DC+2	Inverter input DC+
7	VH	Signal input for high-side V phase	24	V	Output V phase
8	VL	Signal input for low-side V phase	25	DC+1	Inverter input DC+
9	RV+	V phase shunt +	26	U	Output U phase
10	RV-	V phase shunt -			
11	RST	Fault latch reset (min. 500ns pulse)			
12	FO	Fault latch input/output (negative logic, open drain)			
13	UH	Signal input for high-side U phase			
14	UL	Signal input for low-side U phase			
15	RU+	U phase shunt +			
16	RU-	U phase shunt -			
17	THERM1	Temperature sensor connector			



Vincotech

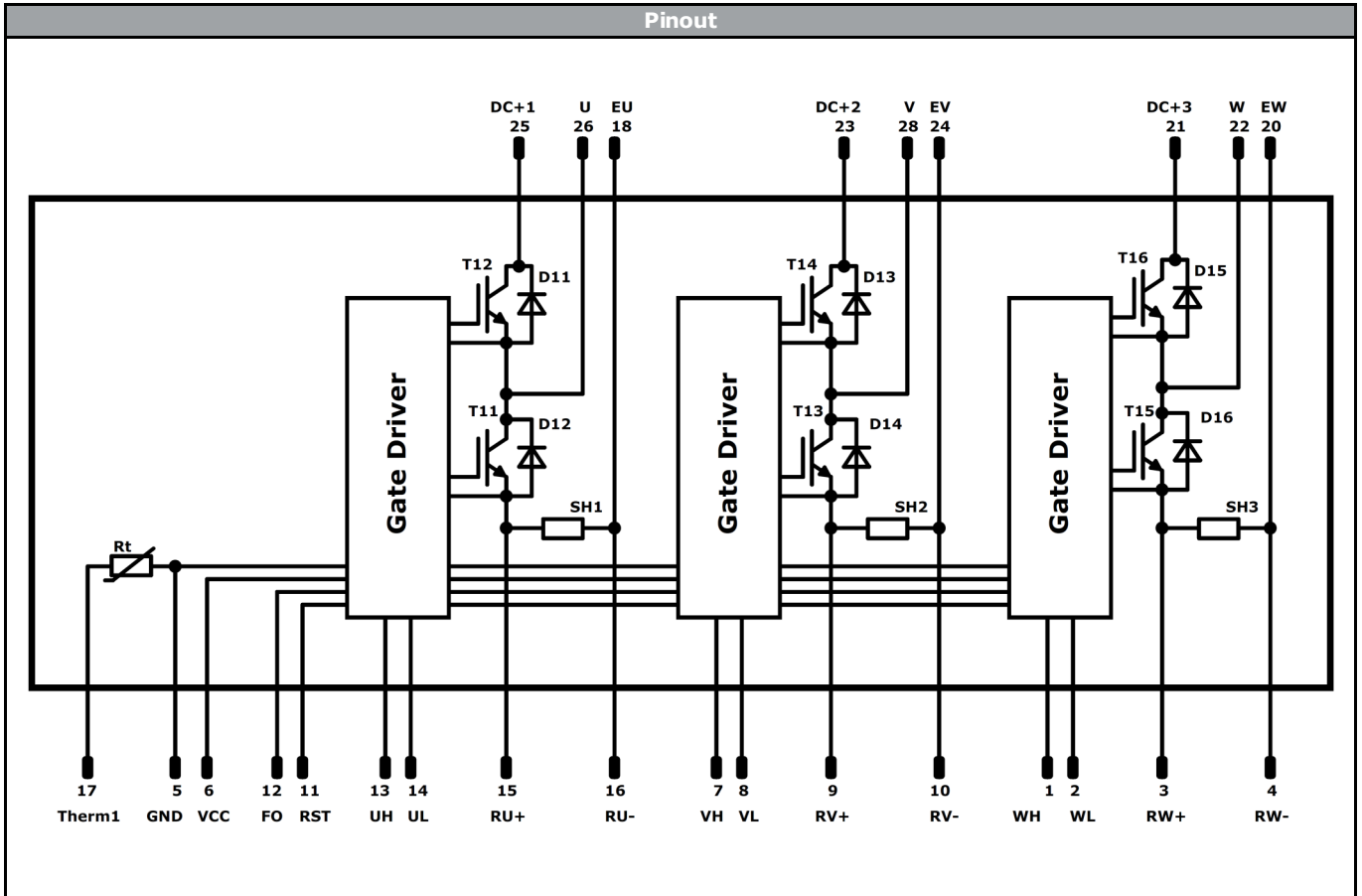

Identification					
ID	Component	Voltage	Current	Function	Comment
T11, T12, T13, T14, T15, T16	IGBT	1200 V	12 A	Inverter Switch	
D11, D12, D13, D14, D15, D16	FWD	1200 V	12 A	Inverter Diode	
SH1, SH2, SH3	Shunt		9 A	Inverter Shunt	
Rt	NTC			Thermistor	



Vincotech

Packaging instruction			
Standard packaging quantity (SPQ) 100	>SPQ	Standard	<SPQ Sample

Handling instruction
Handling instructions for <i>flow</i> 1B packages see vincotech.com website.

Package data
Package data for <i>flow</i> 1B packages see vincotech.com website.

UL recognition and file number
This device is certified according to UL 1557 standard, UL file number E192116. For more information see vincotech.com website. 

Document No.:	Date:	Modification:	Pages
20-1B12IPA015SC-L579F09-D3-14	26 July, 2019	Modified remark on Gate Driver, $V_{outFAULT}$ condition	5

DISCLAIMER

The information, specifications, procedures, methods and recommendations herein (together "information") are presented by Vincotech to reader in good faith, are believed to be accurate and reliable, but may well be incomplete and/or not applicable to all conditions or situations that may exist or occur. Vincotech reserves the right to make any changes without further notice to any products to improve reliability, function or design. No representation, guarantee or warranty is made to reader as to the accuracy, reliability or completeness of said information or that the application or use of any of the same will avoid hazards, accidents, losses, damages or injury of any kind to persons or property or that the same will not infringe third parties rights or give desired results. It is reader's sole responsibility to test and determine the suitability of the information and the product for reader's intended use.

LIFE SUPPORT POLICY

Vincotech products are not authorised for use as critical components in life support devices or systems without the express written approval of Vincotech.

As used herein:

1. Life support devices or systems are devices or systems which, (a) are intended for surgical implant into the body, or (b) support or sustain life, or (c) whose failure to perform when properly used in accordance with instructions for use provided in labelling can be reasonably expected to result in significant injury to the user.
2. A critical component is any component of a life support device or system whose failure to perform can be reasonably expected to cause the failure of the life support device or system, or to affect its safety or effectiveness.