



flowPIM 1 + PFC

600 V / 50 A

Topology features

- 3x Shunts
- Converter + 2-leg interleaved PFC + Inverter
- On-board Capacitors
- Open Emitter configuration
- Temperature sensor

Component features

- 5us short circuit withstand time
- High speed switching
- Low EMI
- Short tail current

Housing features

- Base isolation: Al₂O₃
- Convex shaped substrate for superior thermal contact
- Thermo-mechanical push-and-pull force relief
- Press-fit pin
- Reliable cold welding connection

Target applications

- Embedded Drives
- Industrial Drives

Types

- 10-PG06PPA050SJ-LJ04B08T

flow 1 12 mm housing

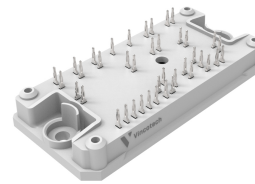

Schematic

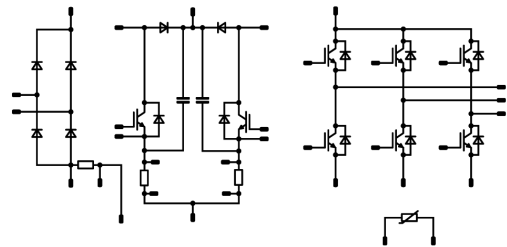



Vincotech

Maximum Ratings

$T_j = 25\text{ °C}$, unless otherwise specified

Parameter	Symbol	Conditions	Value	Unit
Inverter Switch				
Collector-emitter voltage	V_{CES}		600	V
Collector current (DC current)	I_C	$T_j = T_{jmax}$ $T_s = 80\text{ °C}$	49	A
Repetitive peak collector current	I_{CRM}	t_p limited by T_{jmax}	150	A
Total power dissipation	P_{tot}	$T_j = T_{jmax}$ $T_s = 80\text{ °C}$	81	W
Gate-emitter voltage	V_{GES}		± 20	V
Short circuit ratings	t_{SC}	$V_{GE} = 15\text{ V}$, $V_{CC} = 400\text{ V}$ $T_j = 150\text{ °C}$	5	μs
Maximum junction temperature	T_{jmax}		175	$^{\circ}\text{C}$

Inverter Diode				
Peak repetitive reverse voltage	V_{RRM}		600	V
Forward current (DC current)	I_F	$T_j = T_{jmax}$ $T_s = 80\text{ °C}$	36	A
Repetitive peak forward current	I_{FRM}	t_p limited by T_{jmax}	60	A
Total power dissipation	P_{tot}	$T_j = T_{jmax}$ $T_s = 80\text{ °C}$	58	W
Maximum junction temperature	T_{jmax}		175	$^{\circ}\text{C}$

PFC Switch				
Collector-emitter voltage	V_{CES}		650	V
Collector current (DC current)	I_C	$T_j = T_{jmax}$ $T_s = 80\text{ °C}$	47	A
Repetitive peak collector current	I_{CRM}	t_p limited by T_{jmax}	150	A
Total power dissipation	P_{tot}	$T_j = T_{jmax}$ $T_s = 80\text{ °C}$	81	W
Gate-emitter voltage	V_{GES}		± 20	V
Maximum junction temperature	T_{jmax}		175	$^{\circ}\text{C}$



Vincotech

Maximum Ratings

$T_j = 25\text{ °C}$, unless otherwise specified

Parameter	Symbol	Conditions	Value	Unit
PFC Diode				
Peak repetitive reverse voltage	V_{RRM}		600	V
Forward current (DC current)	I_F	$T_j = T_{jmax}$ $T_s = 80\text{ °C}$	53	A
Repetitive peak forward current	I_{FRM}	t_p limited by T_{jmax}	120	A
Surge (non-repetitive) forward current	I_{FSM}	Single Half Sine Wave, $t_p = 10\text{ ms}$ $T_j = 25\text{ °C}$	480	A
Total power dissipation	P_{tot}	$T_j = T_{jmax}$ $T_s = 80\text{ °C}$	73	W
Maximum junction temperature	T_{jmax}		175	°C

PFC Sw. Protection Diode

Peak repetitive reverse voltage	V_{RRM}		650	V
Forward current (DC current)	I_F	$T_j = T_{jmax}$ $T_s \leq 80\text{ °C}$	20 ⁽¹⁾	A
Repetitive peak forward current	I_{FRM}	t_p limited by T_{jmax}	20	A
Total power dissipation	P_{tot}	$T_j = T_{jmax}$ $T_s = 80\text{ °C}$	33	W
Maximum junction temperature	T_{jmax}		175	°C

⁽¹⁾ limited by I_{FRM}

Rectifier Diode

Peak repetitive reverse voltage	V_{RRM}		1600	V
Forward current (DC current)	I_F	$T_j = T_{jmax}$ $T_s = 80\text{ °C}$	99	A
Surge (non-repetitive) forward current	I_{FSM}	Single Half Sine Wave, $t_p = 10\text{ ms}$ $T_j = 150\text{ °C}$	890	A
Surge current capability	I^2t		3960	A ² s
Total power dissipation	P_{tot}	$T_j = T_{jmax}$ $T_s = 80\text{ °C}$	108	W
Maximum junction temperature	T_{jmax}		150	°C

Shunt

DC current	I		31,6	A
Power dissipation	P_{tot}	$T_c = 70\text{ °C}$	2	W
Operation Temperature	T_{op}		-65 ... 170	°C



Vincotech

Maximum Ratings

$T_j = 25\text{ °C}$, unless otherwise specified

Parameter	Symbol	Conditions	Value	Unit
PFC Shunt				
DC current	I		31,6	A
Power dissipation	P_{tot}	$T_c = 70\text{ °C}$	2	W
Operation Temperature	T_{op}		-65 ... 170	°C

Capacitor (PFC)

Maximum DC voltage	V_{MAX}		630	V
Operation Temperature	T_{op}		-55 ... 150	°C

Module Properties

Thermal Properties

Storage temperature	T_{stg}		-40...+125	°C
Operation temperature under switching condition	T_{jop}		$-40...+(T_{jmax} - 25)$	°C

Isolation Properties

Isolation voltage	V_{isol}	DC Test Voltage* $t_p = 2\text{ s}$	6000	V
Isolation voltage	V_{isol}	AC Voltage $t_p = 1\text{ min}$	2500	V
Creepage distance			>12,7	mm
Clearance			7,82	mm
Comparative Tracking Index	CTI		≥ 600	

*100 % tested in production



Vincotech

Characteristic Values

Parameter	Symbol	Conditions					Values			Unit
		V_{GS} [V]	V_{GE} [V]	V_{DS} [V]	I_D [A]	T_j [°C]	Min	Typ	Max	

Inverter Switch

Static

Gate-emitter threshold voltage	$V_{GE(th)}$	$V_{CE} = V_{GE}$			0,0008	25	4,1	5,1	5,7	V
Collector-emitter saturation voltage	$V_{CE(sat)}$		15		50	25 125 150		1,49 1,61 1,64	1,8 ⁽²⁾	V
Collector-emitter cut-off current	I_{CES}		0	600		25			2,8	μA
Gate-emitter leakage current	I_{GES}		20	0		25			100	nA
Internal gate resistance	r_g							None		Ω
Input capacitance	C_{ies}							1950		pF
Output capacitance	C_{oes}	$f = 1$ Mhz	0	25		25		83		pF
Reverse transfer capacitance	C_{res}							67		pF
Gate charge	Q_g	$V_{CC} = 480$ V	15		50	25		249		nC

Thermal

Thermal resistance junction to sink ⁽³⁾	$R_{th(j-s)}$	$\lambda_{paste} = 3,4$ W/mK (PSX)						1,18		K/W
--	---------------	------------------------------------	--	--	--	--	--	------	--	-----

Dynamic

Turn-on delay time	$t_{d(on)}$					25 125 150		70 70 71,2		ns
Rise time	t_r					25 125 150		45,2 43,2 42,8		ns
Turn-off delay time	$t_{d(off)}$					25 125 150		114,8 133,6 138,6		ns
Fall time	t_f					25 125 150		22,47 34,2 41,12		ns
Turn-on energy (per pulse)	E_{on}	$Q_{tFWD} = 1,62$ μC $Q_{tFWD} = 3,09$ μC $Q_{tFWD} = 3,57$ μC				25 125 150		1,84 2,2 2,28		mWs
Turn-off energy (per pulse)	E_{off}					25 125 150		0,536 0,839 0,941		mWs



Vincotech

Characteristic Values

Parameter	Symbol	Conditions					Values			Unit
		V_{GE} [V] V_{GS} [V]	V_{CE} [V] V_{DS} [V] V_F [V]	I_C [A] I_D [A] I_F [A]	T_j [°C]	Min	Typ	Max		

Inverter Diode

Static

Forward voltage	V_F				30	25 150	1,25	1,64 1,55	1,95 ⁽²⁾	V
Reverse leakage current	I_R	$V_i = 600$ V				25			27	μA

Thermal

Thermal resistance junction to sink ⁽³⁾	$R_{th(j-s)}$	$\lambda_{paste} = 3,4$ W/mK (PSX)						1,63		K/W
--	---------------	---------------------------------------	--	--	--	--	--	------	--	-----

Dynamic

Peak recovery current	I_{RM}	$di/dt=245$ A/μs $di/dt=545$ A/μs $di/dt=378$ A/μs	±15	350	50	25		10,63		A
Reverse recovery time	t_{rr}					125		16,09	ns	
						150		16,77		
						25		251,47		
Recovered charge	Q_r					125		331,66	μC	
						150		392,82		
		25		1,62						
Reverse recovered energy	E_{rec}	125		3,09	mWs					
		150		3,57						
		25		0,406						
Peak rate of fall of recovery current	$(di_{rr}/dt)_{max}$	125		0,762	A/μs					
		150		0,892						
		25		76,03						
						125		88,46		
						150		100,72		



Vincotech

Characteristic Values

Parameter	Symbol	Conditions					Values			Unit
		V_{GS} [V]	V_{GE} [V]	V_{DS} [V]	I_D [A]	T_j [°C]	Min	Typ	Max	

PFC Switch

Static

Gate-emitter threshold voltage	$V_{GE(th)}$	$V_{CE} = V_{GE}$			0,0005	25	3,3	4	4,7	V
Collector-emitter saturation voltage	$V_{CE(sat)}$		15		50	25 125 150		1,52 1,64 1,7	2,22 ⁽²⁾	V
Collector-emitter cut-off current	I_{CES}		0	650		25			40	μA
Gate-emitter leakage current	I_{GES}		20	0		25			120	nA
Internal gate resistance	r_g							None		Ω
Input capacitance	C_{ies}							3000		pF
Output capacitance	C_{oes}	$f = 1$ Mhz	0	25		25		50		pF
Reverse transfer capacitance	C_{res}							11		pF
Gate charge	Q_g	$V_{CC} = 520$ V	15		50	25		120		nC

Thermal

Thermal resistance junction to sink ⁽³⁾	$R_{th(j-s)}$	$\lambda_{paste} = 3,4$ W/mK (PSX)						1,17		K/W
--	---------------	------------------------------------	--	--	--	--	--	------	--	-----

Dynamic

Turn-on delay time	$t_{d(on)}$					25 125 150		17,17 16,98 16,85		ns
Rise time	t_r					25 125 150		7,88 9,19 9,73		ns
Turn-off delay time	$t_{d(off)}$					25 125 150		86,14 103,51 107,64		ns
Fall time	t_f					25 125 150		1,5 9,65 14,21		ns
Turn-on energy (per pulse)	E_{on}	$Q_{tFWD} = 0,776$ μC $Q_{tFWD} = 2,15$ μC $Q_{tFWD} = 2,7$ μC				25 125 150		0,438 0,782 0,912		mWs
Turn-off energy (per pulse)	E_{off}					25 125 150		0,314 0,464 0,506		mWs



Vincotech

Characteristic Values

Parameter	Symbol	Conditions					Values			Unit
		V_{GE} [V] V_{GS} [V]	V_{CE} [V] V_{DS} [V] V_F [V]	I_C [A] I_D [A] I_F [A]	T_j [°C]	Min	Typ	Max		
PFC Diode										
Static										
Forward voltage	V_F				60	25 125 150		1,89 1,57 1,5	2,5 ⁽²⁾	V
Reverse leakage current	I_R	$V_T = 600$ V				25			25	μA
Thermal										
Thermal resistance junction to sink ⁽³⁾	$R_{th(j-s)}$	$\lambda_{paste} = 3,4$ W/mK (PSX)						1,3		K/W
Dynamic										
Peak recovery current	I_{RM}					25 125 150		67,08 102,58 115,5		A
Reverse recovery time	t_{rr}					25 125 150		22,26 37,32 41,76		ns
Recovered charge	Q_r	$di/dt=6084$ A/μs $di/dt=4768$ A/μs $di/dt=5168$ A/μs	0/15	400	50	25 125 150		0,776 2,15 2,7		μC
Reverse recovered energy	E_{rec}					25 125 150		0,167 0,467 0,588		mWs
Peak rate of fall of recovery current	$(di_r/dt)_{max}$					25 125 150		7172,43 6461,81 6301,69		A/μs



Vincotech

Characteristic Values

Parameter	Symbol	Conditions					Values			Unit
		V_{GS} [V]	V_{GE} [V]	V_{DS} [V]	V_{CE} [V]	T_j [°C]	Min	Typ	Max	

PFC Sw. Protection Diode

Static

Forward voltage	V_F				10	25 125	1,23	1,67 1,54	1,87 ⁽²⁾	V
Reverse leakage current	I_R	$V_r = 650$ V				25			0,14	μA

Thermal

Thermal resistance junction to sink ⁽³⁾	$R_{th(j-s)}$	$\lambda_{paste} = 3,4$ W/mK (PSX)						2,87		K/W
--	---------------	------------------------------------	--	--	--	--	--	------	--	-----

Rectifier Diode

Static

Forward voltage	V_F				60	25 125 150		1,04 0,973 0,956	1,5 ⁽²⁾	V
Reverse leakage current	I_R	$V_r = 1600$ V				25 150			100 2	μA

Thermal

Thermal resistance junction to sink ⁽³⁾	$R_{th(j-s)}$	$\lambda_{paste} = 3,4$ W/mK (PSX)						0,65		K/W
--	---------------	------------------------------------	--	--	--	--	--	------	--	-----

Shunt

Static

Resistance	R							2		mΩ
Temperature coefficient	tc								275	ppm/K



Vincotech

Characteristic Values

Parameter	Symbol	Conditions					Values			Unit
		V_{GE} [V] V_{GS} [V]	V_{CE} [V] V_{DS} [V] V_F [V]	I_C [A] I_D [A] I_F [A]	T_j [°C]	Min	Typ	Max		

PFC Shunt

Static

Resistance	R						2			mΩ
Temperature coefficient	tc							275		ppm/K

Capacitor (PFC)

Static

Capacitance	C	DC bias voltage = 0 V				25		33		nF
Tolerance							-5		5	%

Thermistor

Static

Rated resistance	R					25		22		kΩ
Deviation of R100	$\Delta_{R/R}$	$R_{100} = 1484 \Omega$				100	-5		5	%
Power dissipation	P					25		130		mW
Power dissipation constant	d					25		1,5		mW/K
B-value	$B_{(25/50)}$	Tol. $\pm 1 \%$						3962		K
B-value	$B_{(25/100)}$	Tol. $\pm 1 \%$						4000		K
Vincotech Thermistor Reference									I	

(2) Value at chip level

(3) Only valid with pre-applied Vincotech thermal interface material.



Inverter Switch Characteristics

figure 1. IGBT

Typical output characteristics

$$I_C = f(V_{CE})$$

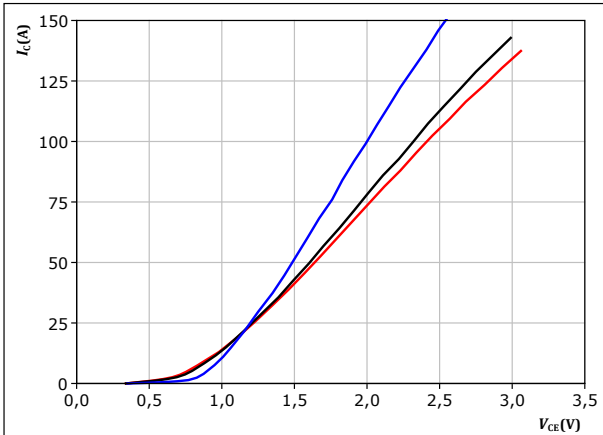

$t_p = 250 \mu s$
 $V_{GE} = 15 V$
 $T_j:$ — 25 °C
— 125 °C
— 150 °C

figure 2. IGBT

Typical output characteristics

$$I_C = f(V_{CE})$$

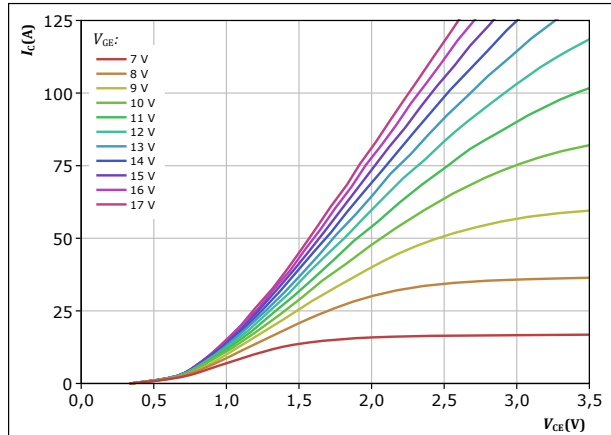

$t_p = 250 \mu s$
 $T_j = 150 \text{ }^\circ C$
 V_{GE} from 7 V to 17 V in steps of 1 V

figure 3. IGBT

Typical transfer characteristics

$$I_C = f(V_{GE})$$

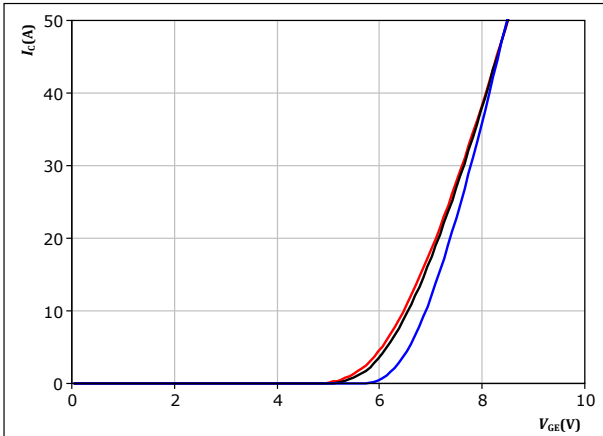

$t_p = 250 \mu s$
 $V_{CE} = 10 V$
 $T_j:$ — 25 °C
— 125 °C
— 150 °C

figure 4. IGBT

Transient thermal impedance as a function of pulse width

$$Z_{th(j-s)} = f(t_p)$$

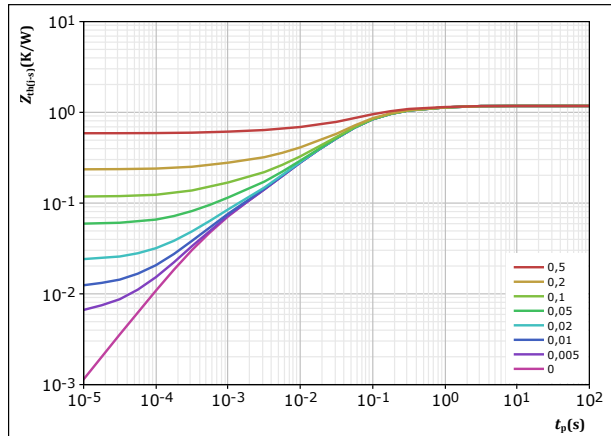

$D = t_p / T$
 $R_{th(j-s)} = 1,176 \text{ K/W}$
IGBT thermal model values

R (K/W)	τ (s)
1,28E-01	9,19E-01
3,00E-01	1,49E-01
5,67E-01	4,76E-02
1,34E-01	6,63E-03
4,70E-02	5,83E-04



Inverter Switch Characteristics

figure 5. IGBT

Safe operating area

$$I_C = f(V_{CE})$$

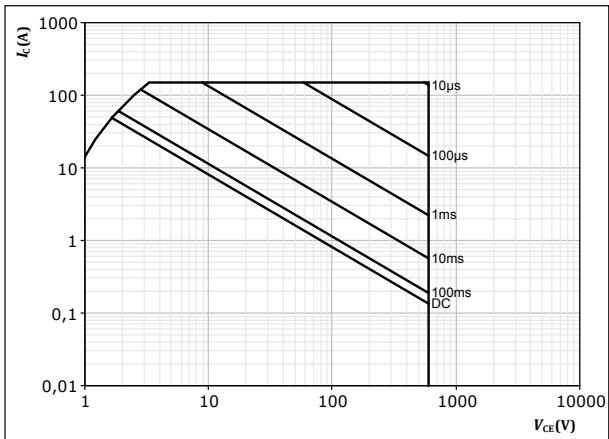

$D =$ single pulse
 $T_s = 80 \text{ } ^\circ\text{C}$
 $V_{CE} = 15 \text{ V}$
 $T_j = T_{jmax}$



Inverter Diode Characteristics

figure 6. FWD

Typical forward characteristics

$$I_F = f(V_F)$$

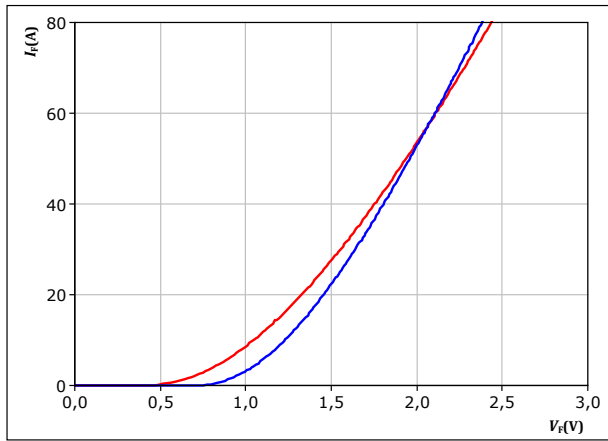

$t_p = 250 \mu s$
 T_j : — 25 °C
 — 150 °C

figure 7. FWD

Transient thermal impedance as a function of pulse width

$$Z_{th(j-s)} = f(t_p)$$

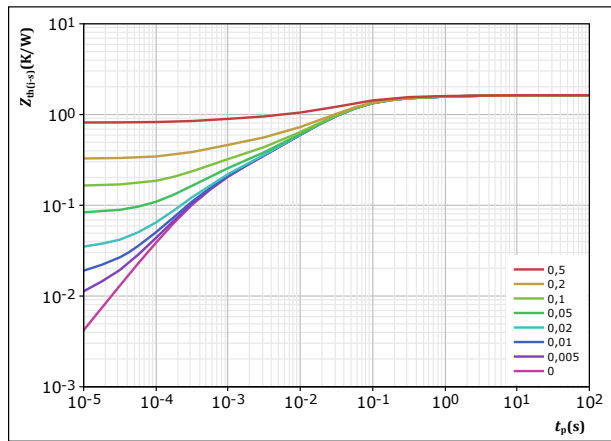

$D = t_p / T$
 $R_{th(j-s)} = 1,633 \text{ K/W}$
 FWD thermal model values

$R \text{ (K/W)}$	$\tau \text{ (s)}$
7,13E-02	2,70E+00
1,55E-01	3,01E-01
7,25E-01	5,48E-02
3,93E-01	1,54E-02
1,57E-01	2,76E-03
1,32E-01	4,03E-04



PFC Switch Characteristics

figure 8. IGBT

Typical output characteristics
 $I_C = f(V_{CE})$

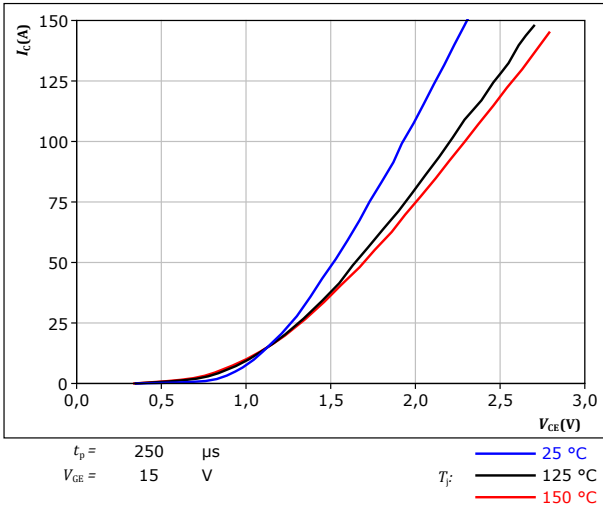

figure 9. IGBT

Typical output characteristics
 $I_C = f(V_{CE})$

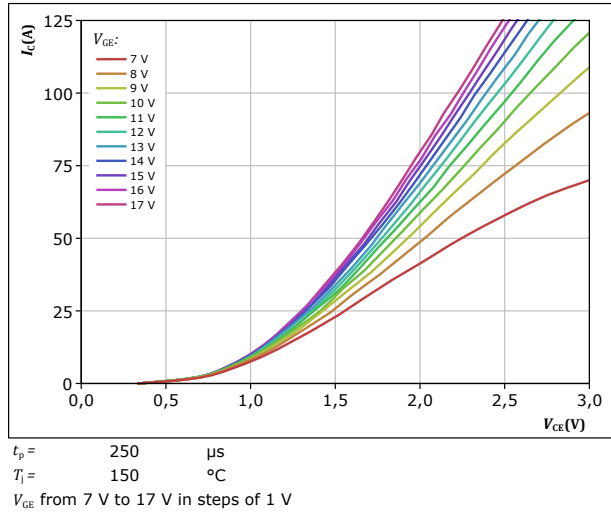

figure 10. IGBT

Typical transfer characteristics
 $I_C = f(V_{GE})$

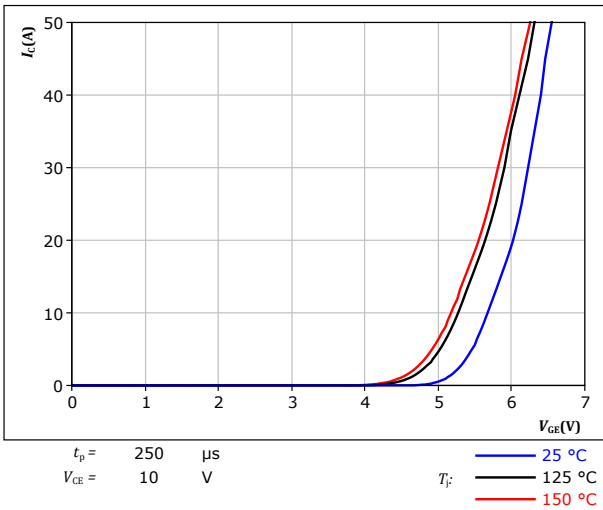
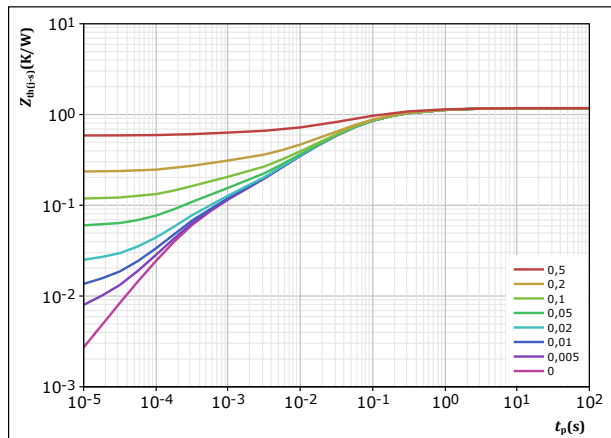

figure 11. IGBT

Transient thermal impedance as a function of pulse width
 $Z_{th(j-s)} = f(t_p)$



IGBT thermal model values

R (K/W)	τ (s)
9,21E-02	1,52E+00
2,50E-01	2,21E-01
4,87E-01	5,30E-02
2,29E-01	1,06E-02
4,67E-02	2,01E-03
6,92E-02	3,15E-04



PFC Switch Characteristics

figure 12. IGBT

Safe operating area

$$I_C = f(V_{CE})$$

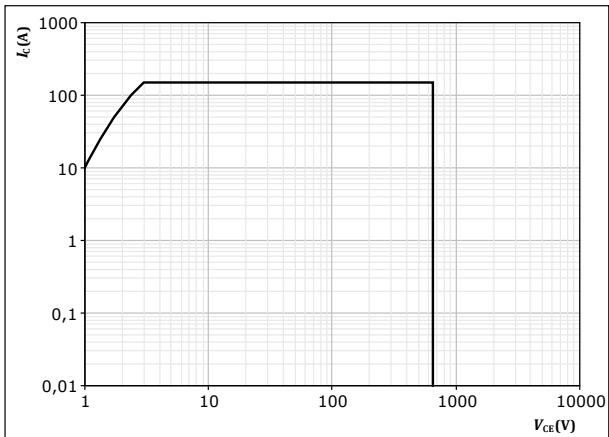

D = single pulse
T_s = 80 °C
V_{CE} = 15 V
T_j = T_{jmax}



PFC Diode Characteristics

figure 13. FWD

Typical forward characteristics

$$I_F = f(V_F)$$

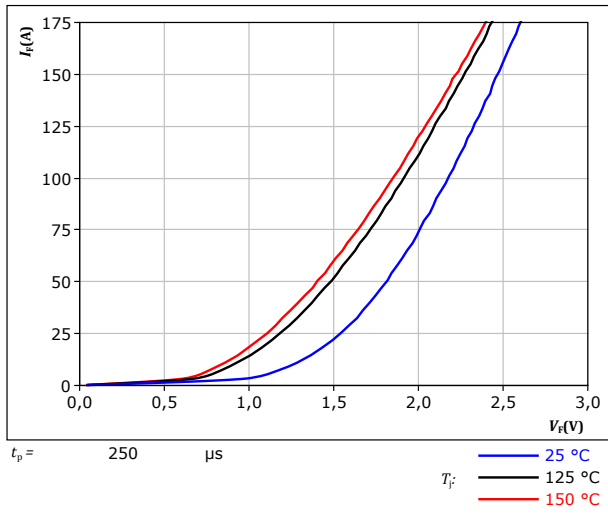
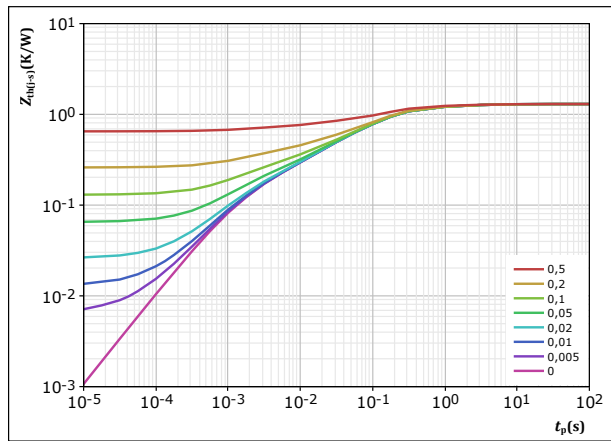

figure 14. FWD

Transient thermal impedance as a function of pulse width

$$Z_{th(j-s)} = f(t_p)$$



$D = t_p / T$
 $R_{th(j-s)} = 1,299 \text{ K/W}$
 FWD thermal model values

R (K/W)	τ (s)
6,87E-02	3,97E+00
2,08E-01	5,47E-01
7,02E-01	1,09E-01
2,07E-01	1,20E-02
1,14E-01	1,37E-03



PFC Sw. Protection Diode Characteristics

figure 15. FWD

Typical forward characteristics

$$I_F = f(V_F)$$

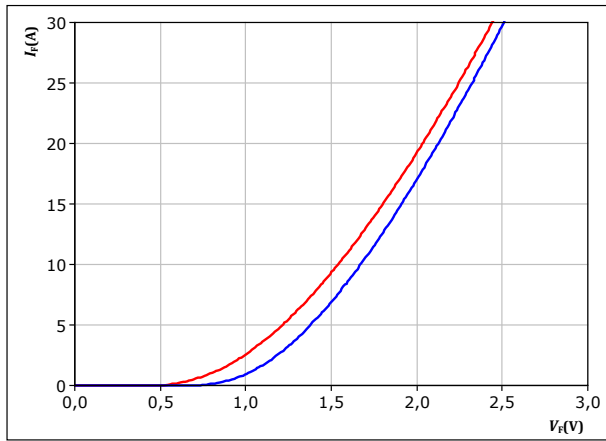

$t_p = 250 \mu s$
 $T_j: \text{ — } 25 \text{ }^\circ\text{C}$
 $\text{ — } 125 \text{ }^\circ\text{C}$

figure 16. FWD

Transient thermal impedance as a function of pulse width

$$Z_{th(j-s)} = f(t_p)$$

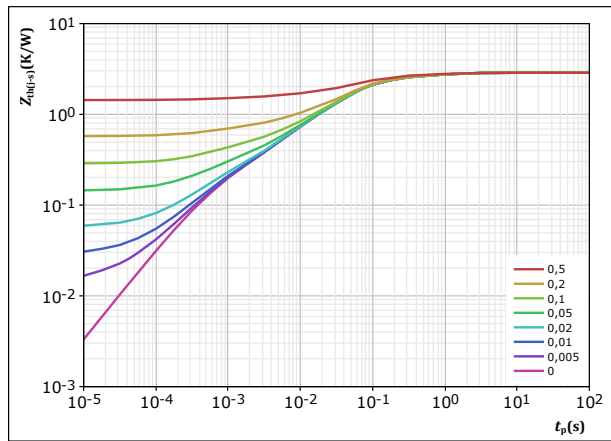

$D = t_p / T$
 $R_{th(j-s)} = 2,874 \text{ K/W}$
FWD thermal model values

R (K/W)	τ (s)
2,86E-01	1,08E+00
5,75E-01	1,73E-01
1,57E+00	4,54E-02
3,05E-01	5,64E-03
1,34E-01	5,58E-04



Rectifier Diode Characteristics

figure 17. Rectifier

Typical forward characteristics

$$I_F = f(V_F)$$

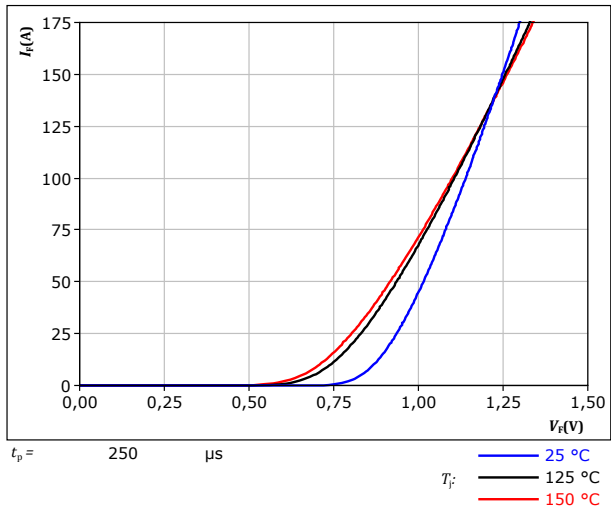
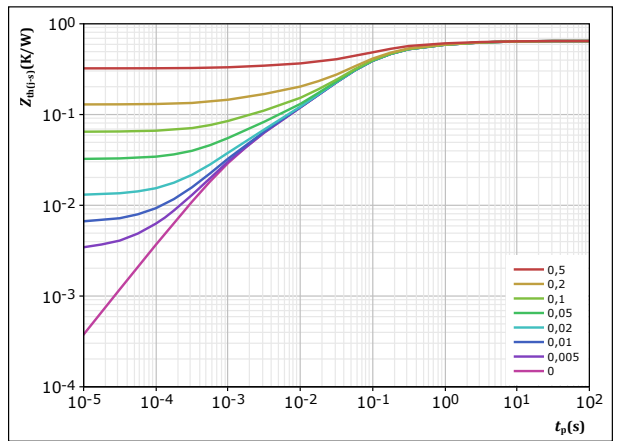

figure 18. Rectifier

Transient thermal impedance as a function of pulse width

$$Z_{th(j-s)} = f(t_p)$$



$D = \frac{t_p}{T}$
 $R_{th(j-s)} = 0,646 \text{ K/W}$
 Rectifier thermal model values

R (K/W)	τ (s)
2,68E-02	6,32E+00
7,07E-02	1,29E+00
1,46E-01	2,31E-01
3,15E-01	6,56E-02
5,35E-02	9,74E-03
3,41E-02	1,27E-03



Thermistor Characteristics

figure 19. Thermistor

Typical NTC characteristic as function of temperature

$$R_T = f(T)$$

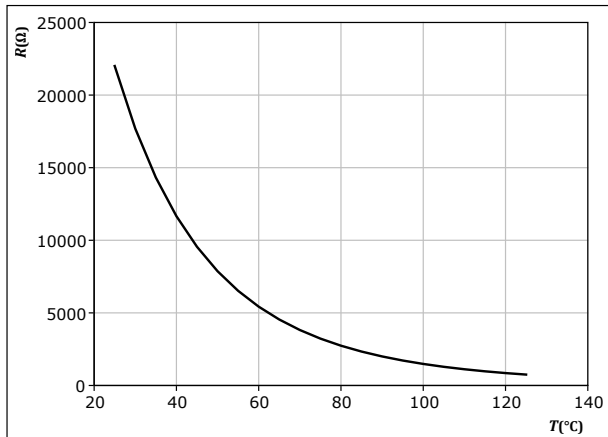



Inverter Switching Characteristics

figure 20. IGBT

Typical switching energy losses as a function of collector current

$$E = f(I_c)$$

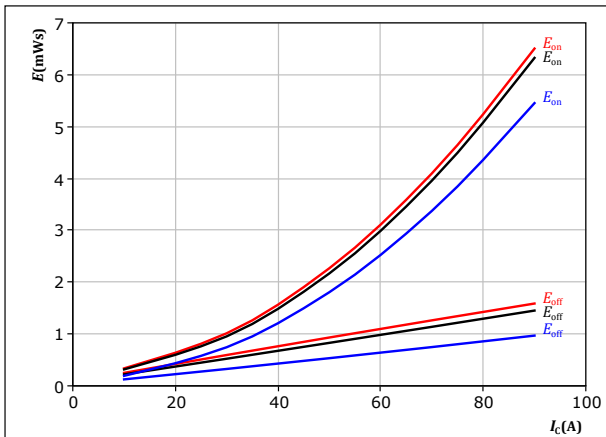

With an inductive load at

$V_{CE} = 350 \text{ V}$
 $V_{GE} = \pm 15 \text{ V}$
 $R_{g\text{on}} = 8 \ \Omega$
 $R_{g\text{off}} = 8 \ \Omega$

T_j : — 25 °C
 — 125 °C
 — 150 °C

figure 21. IGBT

Typical switching energy losses as a function of IGBT turn on gate resistor

$$E = f(R_g)$$

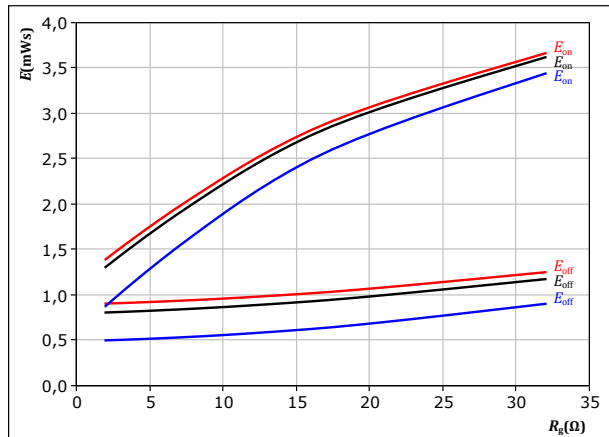

With an inductive load at

$V_{CE} = 350 \text{ V}$
 $V_{GE} = \pm 15 \text{ V}$
 $I_c = 50 \text{ A}$

T_j : — 25 °C
 — 125 °C
 — 150 °C

figure 22. FWD

Typical reverse recovered energy loss as a function of collector current

$$E_{rec} = f(I_c)$$

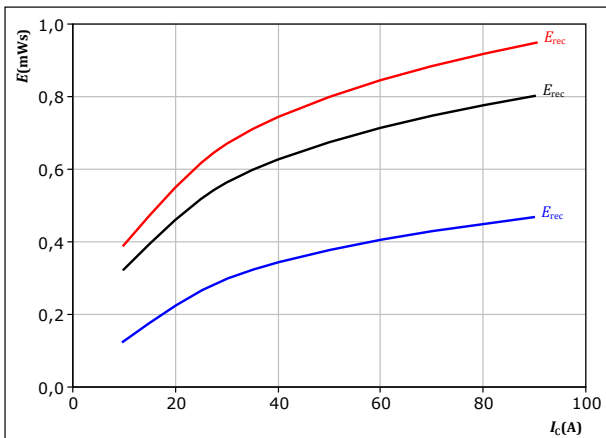

With an inductive load at

$V_{CE} = 350 \text{ V}$
 $V_{GE} = \pm 15 \text{ V}$
 $R_{g\text{on}} = 8 \ \Omega$

T_j : — 25 °C
 — 125 °C
 — 150 °C

figure 23. FWD

Typical reverse recovered energy loss as a function of IGBT turn on gate resistor

$$E_{rec} = f(R_g)$$

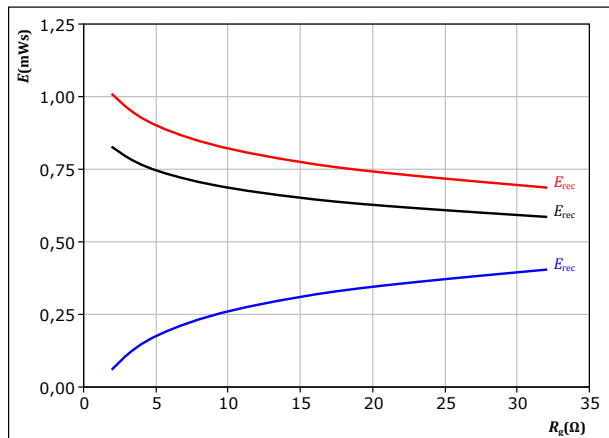

With an inductive load at

$V_{CE} = 350 \text{ V}$
 $V_{GE} = \pm 15 \text{ V}$
 $I_c = 50 \text{ A}$

T_j : — 25 °C
 — 125 °C
 — 150 °C



Inverter Switching Characteristics

figure 24. IGBT

Typical switching times as a function of collector current
 $t = f(I_c)$

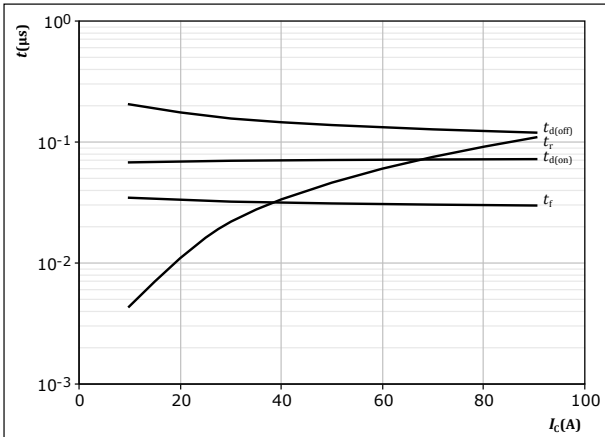

With an inductive load at
 $T_j = 150 \text{ }^\circ\text{C}$
 $V_{CE} = 350 \text{ V}$
 $V_{GE} = \pm 15 \text{ V}$
 $R_{gon} = 8 \text{ } \Omega$
 $R_{goff} = 8 \text{ } \Omega$

figure 25. IGBT

Typical switching times as a function of IGBT turn on gate resistor
 $t = f(R_g)$

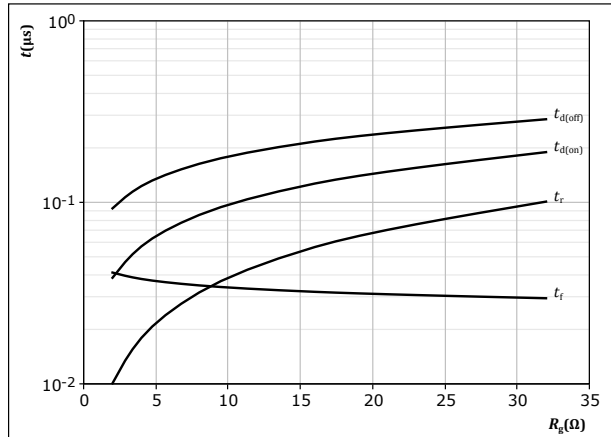

With an inductive load at
 $T_j = 150 \text{ }^\circ\text{C}$
 $V_{CE} = 350 \text{ V}$
 $V_{GE} = \pm 15 \text{ V}$
 $I_c = 50 \text{ A}$

figure 26. FWD

Typical reverse recovery time as a function of collector current
 $t_{rr} = f(I_c)$

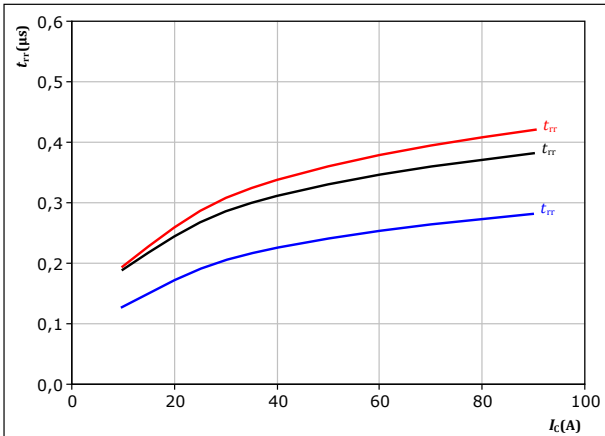

With an inductive load at
 $V_{CE} = 350 \text{ V}$
 $V_{GE} = \pm 15 \text{ V}$
 $R_{gon} = 8 \text{ } \Omega$

T_j :
— 25 $^\circ\text{C}$
— 125 $^\circ\text{C}$
— 150 $^\circ\text{C}$

figure 27. FWD

Typical reverse recovery time as a function of IGBT turn on gate resistor
 $t_{rr} = f(R_{gon})$

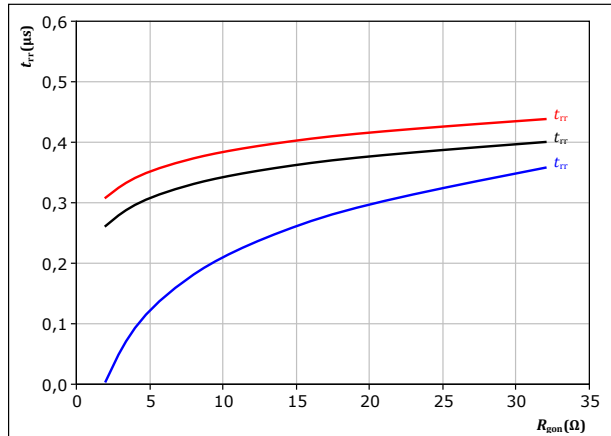

With an inductive load at
 $V_{CE} = 350 \text{ V}$
 $V_{GE} = \pm 15 \text{ V}$
 $I_c = 50 \text{ A}$

T_j :
— 25 $^\circ\text{C}$
— 125 $^\circ\text{C}$
— 150 $^\circ\text{C}$



Inverter Switching Characteristics

figure 28. FWD

Typical recovered charge as a function of collector current

$$Q_r = f(I_c)$$

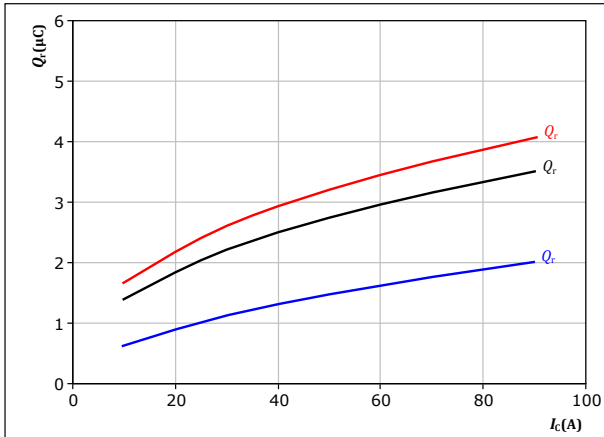

With an inductive load at

$V_{CE} = 350 \text{ V}$
 $V_{GE} = \pm 15 \text{ V}$
 $R_{gon} = 8 \ \Omega$

T_j : — 25 °C
— 125 °C
— 150 °C

figure 29. FWD

Typical recovered charge as a function of IGBT turn on gate resistor

$$Q_r = f(R_{gon})$$

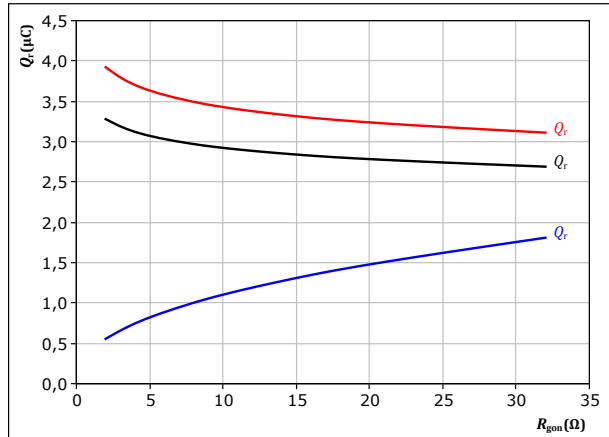

With an inductive load at

$V_{CE} = 350 \text{ V}$
 $V_{GE} = \pm 15 \text{ V}$
 $I_c = 50 \text{ A}$

T_j : — 25 °C
— 125 °C
— 150 °C

figure 30. FWD

Typical peak reverse recovery current as a function of collector current

$$I_{RM} = f(I_c)$$

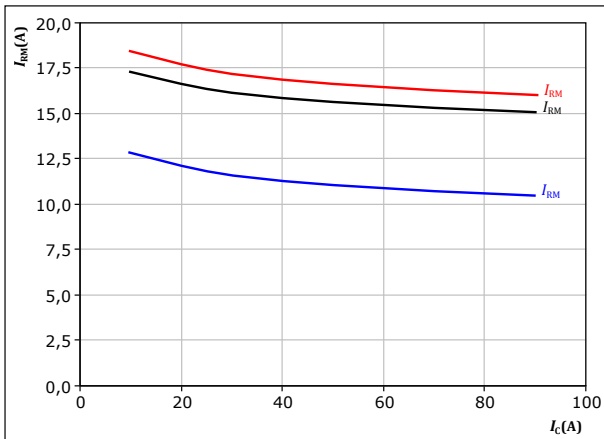

With an inductive load at

$V_{CE} = 350 \text{ V}$
 $V_{GE} = \pm 15 \text{ V}$
 $R_{gon} = 8 \ \Omega$

T_j : — 25 °C
— 125 °C
— 150 °C

figure 31. FWD

Typical peak reverse recovery current as a function of IGBT turn on gate resistor

$$I_{RM} = f(R_{gon})$$

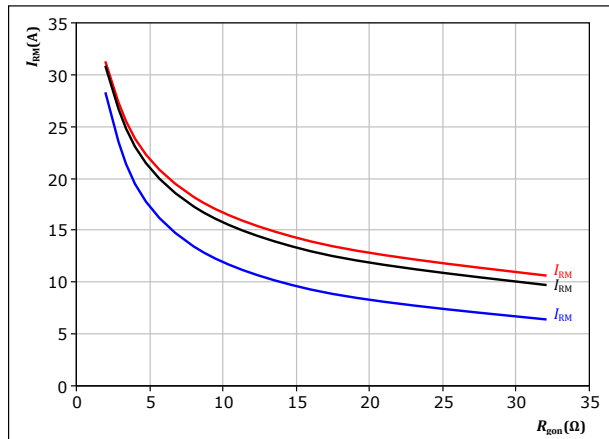

With an inductive load at

$V_{CE} = 350 \text{ V}$
 $V_{GE} = \pm 15 \text{ V}$
 $I_c = 50 \text{ A}$

T_j : — 25 °C
— 125 °C
— 150 °C



Inverter Switching Characteristics

figure 32. FWD

Typical rate of fall of forward and reverse recovery current as a function of collector current
 $di_f/dt, di_{rr}/dt = f(I_C)$

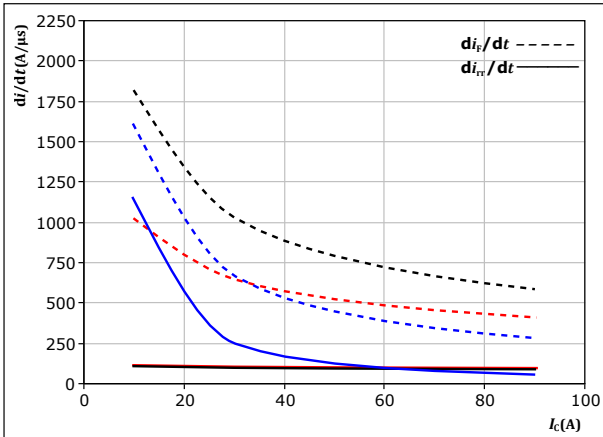

With an inductive load at

$V_{CE} = 350$ V
 $V_{GE} = \pm 15$ V
 $R_{gon} = 8$ Ω

$T_j:$
— 25 °C
— 125 °C
— 150 °C

figure 33. FWD

Typical rate of fall of forward and reverse recovery current as a function of turn on gate resistor
 $di_f/dt, di_{rr}/dt = f(R_{gon})$

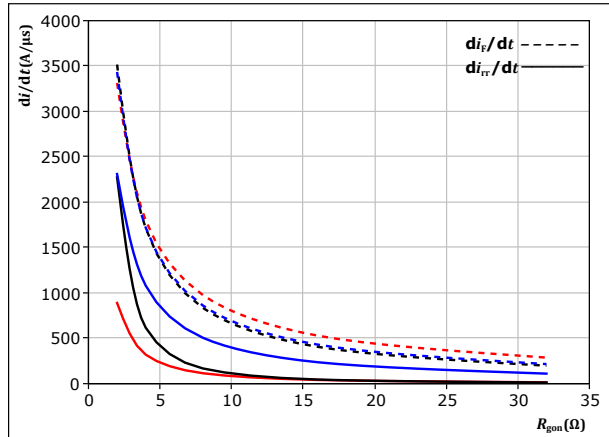

With an inductive load at

$V_{CE} = 350$ V
 $V_{GE} = \pm 15$ V
 $I_C = 50$ A

$T_j:$
— 25 °C
— 125 °C
— 150 °C

figure 34. IGBT

Reverse bias safe operating area

$I_C = f(V_{CE})$

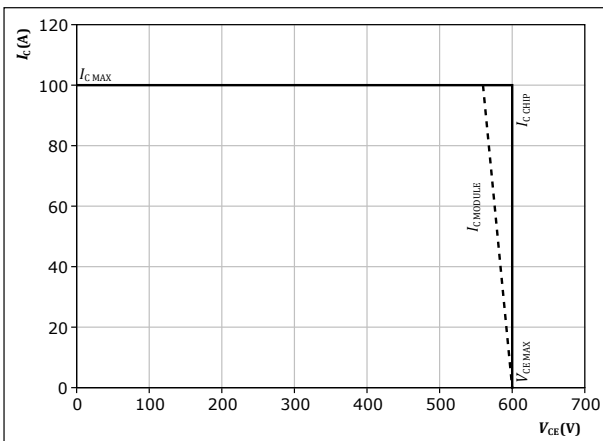

At $T_j = 150$ °C
 $R_{gon} = 8$ Ω
 $R_{goff} = 8$ Ω



PFC Switching Characteristics

figure 35. IGBT

Typical switching energy losses as a function of collector current
 $E = f(I_c)$

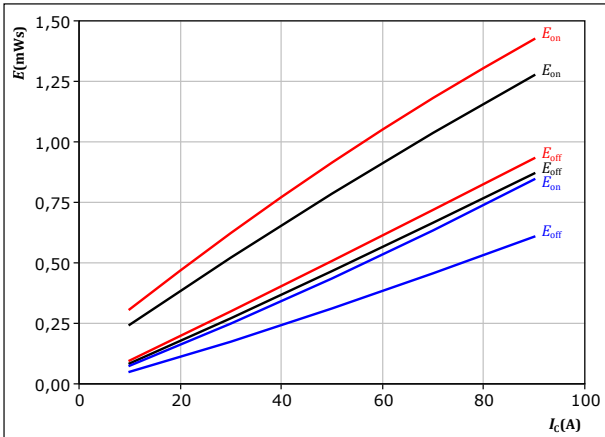

With an inductive load at

$V_{CE} = 400$ V	$T_j = 25$ °C
$V_{GE} = 0/15$ V	$T_j = 125$ °C
$R_{g(on)} = 4$ Ω	$T_j = 150$ °C
$R_{g(off)} = 4$ Ω	

figure 36. IGBT

Typical switching energy losses as a function of IGBT turn on gate resistor
 $E = f(R_g)$

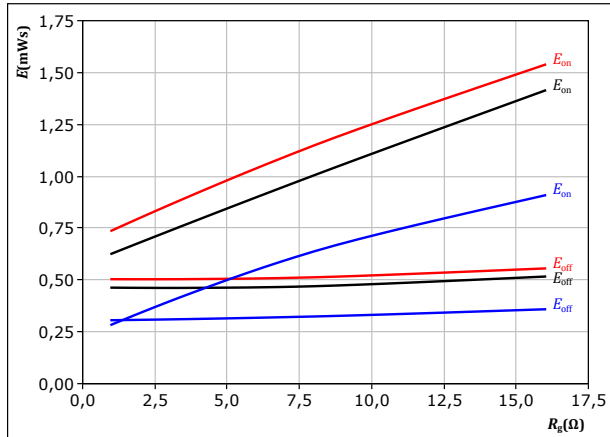

With an inductive load at

$V_{CE} = 400$ V	$T_j = 25$ °C
$V_{GE} = 0/15$ V	$T_j = 125$ °C
$I_c = 50$ A	$T_j = 150$ °C

figure 37. FWD

Typical reverse recovered energy loss as a function of collector current
 $E_{rec} = f(I_c)$

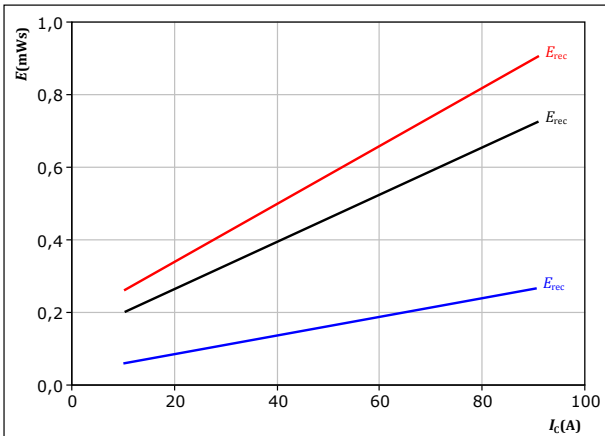

With an inductive load at

$V_{CE} = 400$ V	$T_j = 25$ °C
$V_{GE} = 0/15$ V	$T_j = 125$ °C
$R_{g(on)} = 4$ Ω	$T_j = 150$ °C

figure 38. FWD

Typical reverse recovered energy loss as a function of IGBT turn on gate resistor
 $E_{rec} = f(R_g)$

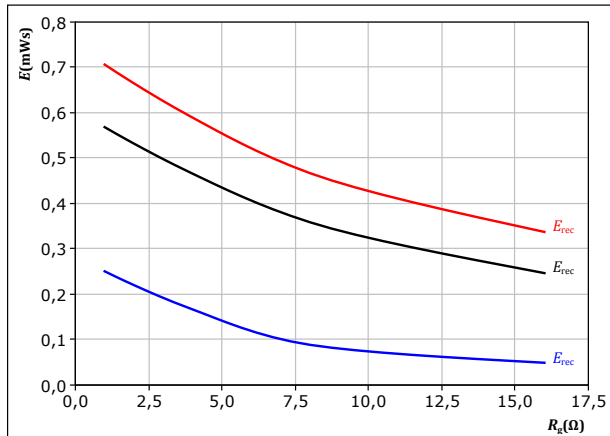

With an inductive load at

$V_{CE} = 400$ V	$T_j = 25$ °C
$V_{GE} = 0/15$ V	$T_j = 125$ °C
$I_c = 50$ A	$T_j = 150$ °C



PFC Switching Characteristics

figure 39. IGBT

Typical switching times as a function of collector current
 $t = f(I_c)$

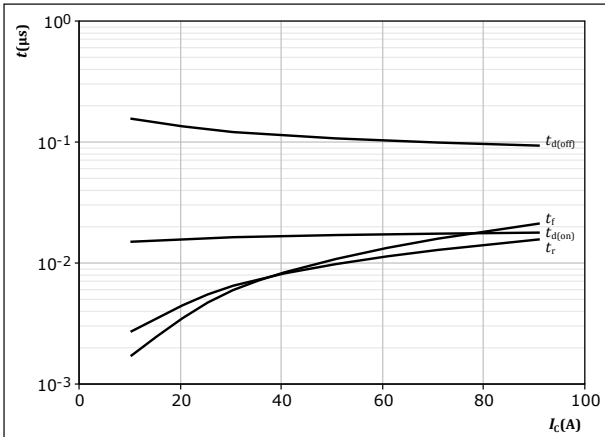

With an inductive load at
 $T_j = 150$ °C
 $V_{CE} = 400$ V
 $V_{GE} = 0/15$ V
 $R_{gon} = 4$ Ω
 $R_{goff} = 4$ Ω

figure 40. IGBT

Typical switching times as a function of IGBT turn on gate resistor
 $t = f(R_g)$

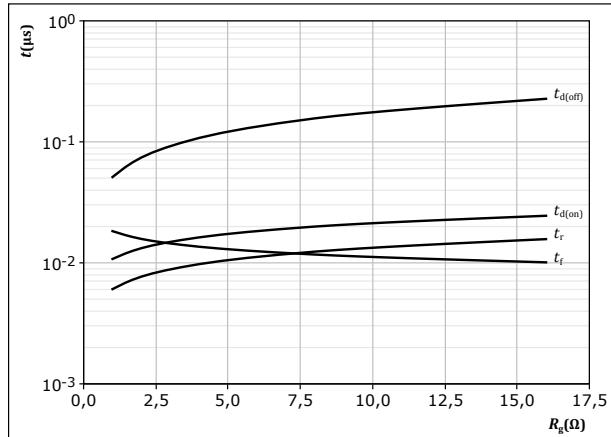

With an inductive load at
 $T_j = 150$ °C
 $V_{CE} = 400$ V
 $V_{GE} = 0/15$ V
 $I_c = 50$ A

figure 41. FWD

Typical reverse recovery time as a function of collector current
 $t_{rr} = f(I_c)$

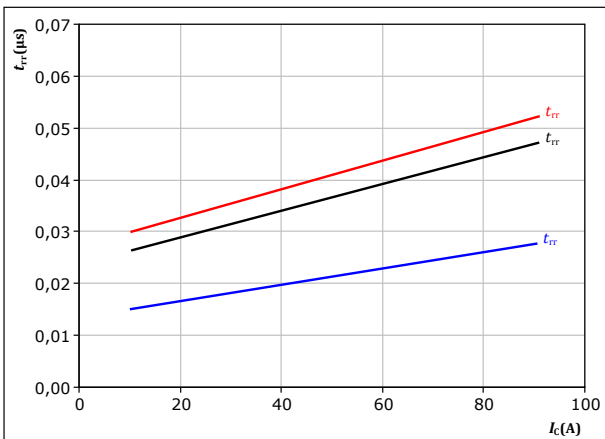

With an inductive load at
 $V_{CE} = 400$ V
 $V_{GE} = 0/15$ V
 $R_{gon} = 4$ Ω

T_j :
— 25 °C
— 125 °C
— 150 °C

figure 42. FWD

Typical reverse recovery time as a function of IGBT turn on gate resistor
 $t_{rr} = f(R_{gon})$

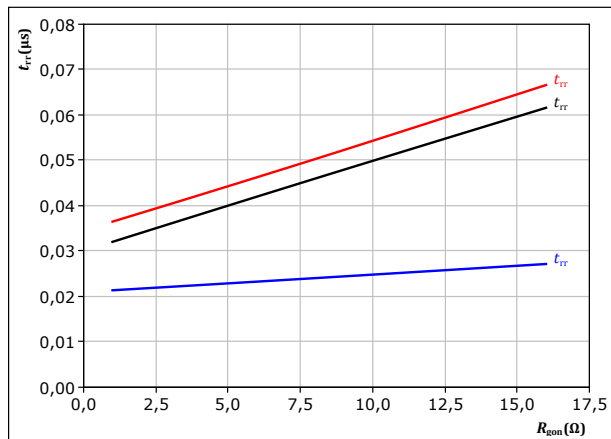

With an inductive load at
 $V_{CE} = 400$ V
 $V_{GE} = 0/15$ V
 $I_c = 50$ A

T_j :
— 25 °C
— 125 °C
— 150 °C



PFC Switching Characteristics

figure 43. FWD

Typical recovered charge as a function of collector current

$$Q_r = f(I_c)$$

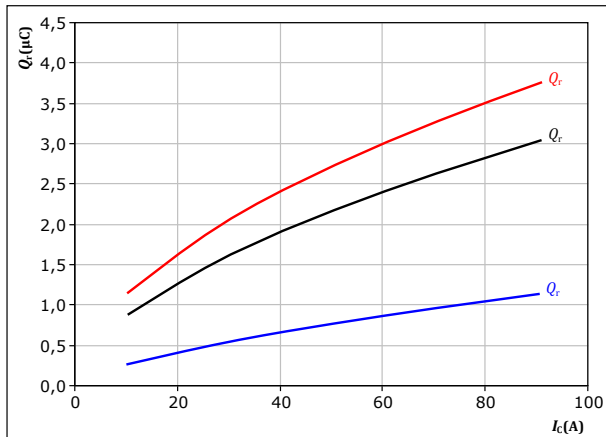

With an inductive load at

$V_{CE} = 400$ V
 $V_{GE} = 0/15$ V
 $R_{gon} = 4$ Ω

T_j : — 25 °C
— 125 °C
— 150 °C

figure 44. FWD

Typical recovered charge as a function of IGBT turn on gate resistor

$$Q_r = f(R_{gon})$$

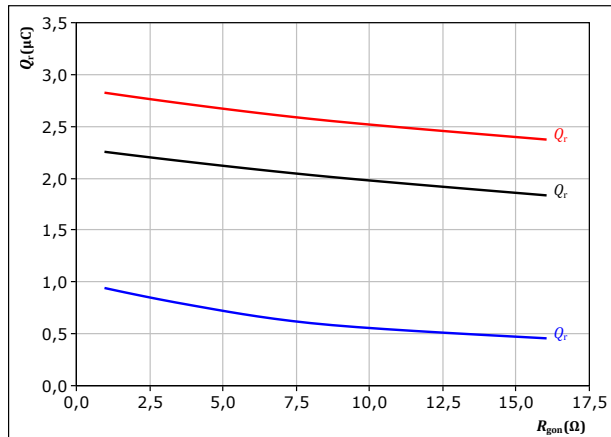

With an inductive load at

$V_{CE} = 400$ V
 $V_{GE} = 0/15$ V
 $I_c = 50$ A

T_j : — 25 °C
— 125 °C
— 150 °C

figure 45. FWD

Typical peak reverse recovery current as a function of collector current

$$I_{RM} = f(I_c)$$

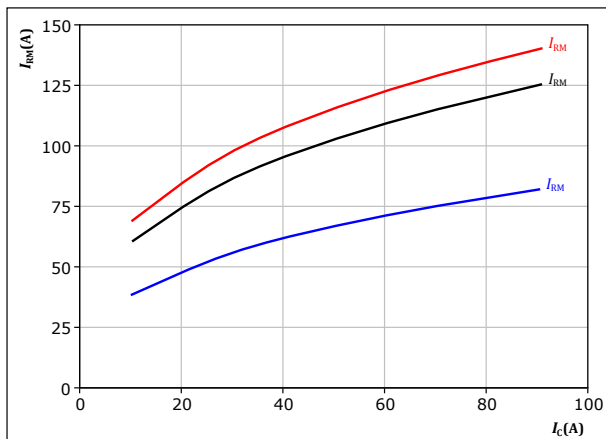

With an inductive load at

$V_{CE} = 400$ V
 $V_{GE} = 0/15$ V
 $R_{gon} = 4$ Ω

T_j : — 25 °C
— 125 °C
— 150 °C

figure 46. FWD

Typical peak reverse recovery current as a function of IGBT turn on gate resistor

$$I_{RM} = f(R_{gon})$$

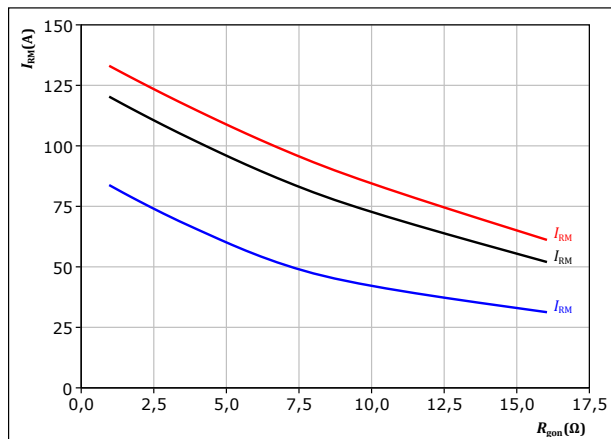

With an inductive load at

$V_{CE} = 400$ V
 $V_{GE} = 0/15$ V
 $I_c = 50$ A

T_j : — 25 °C
— 125 °C
— 150 °C



PFC Switching Characteristics

figure 47. FWD

Typical rate of fall of forward and reverse recovery current as a function of collector current
 $di_i/dt, di_r/dt = f(I_C)$

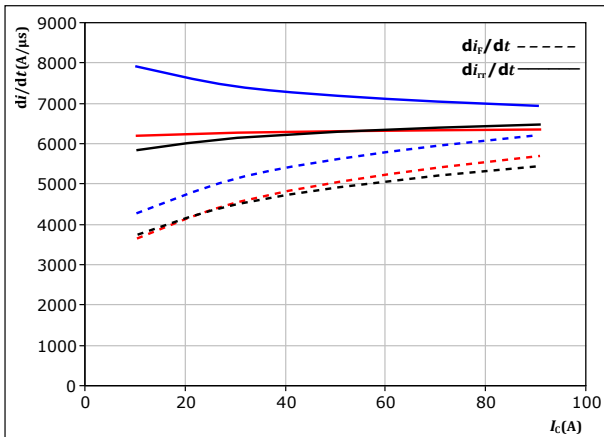

With an inductive load at

$V_{CE} = 400$ V
 $V_{GE} = 0/15$ V
 $R_{gon} = 4$ Ω

T_j : — 25 °C
 — 125 °C
 — 150 °C

figure 48. FWD

Typical rate of fall of forward and reverse recovery current as a function of turn on gate resistor
 $di_i/dt, di_r/dt = f(R_{gon})$

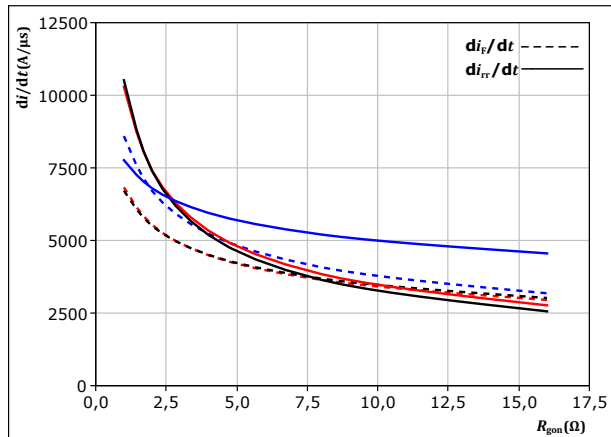

With an inductive load at

$V_{CE} = 400$ V
 $V_{GE} = 0/15$ V
 $I_C = 50$ A

T_j : — 25 °C
 — 125 °C
 — 150 °C

figure 49. IGBT

Reverse bias safe operating area

$I_C = f(V_{CE})$

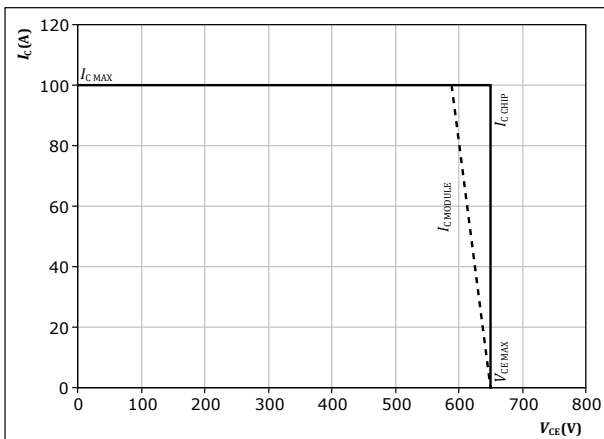

At $T_j = 150$ °C
 $R_{gon} = 4$ Ω
 $R_{goff} = 4$ Ω



Switching Definitions

figure 50. IGBT

Turn-off Switching Waveforms & definition of t_{doff} , t_{Eoff} (t_{Eoff} = integrating time for E_{off})

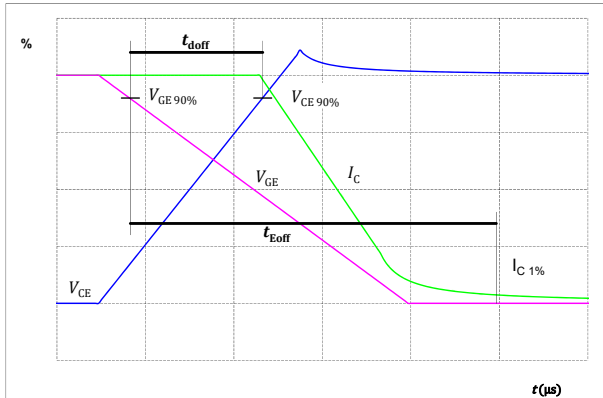

figure 51. IGBT

Turn-on Switching Waveforms & definition of t_{don} , t_{Eon} (t_{Eon} = integrating time for E_{on})

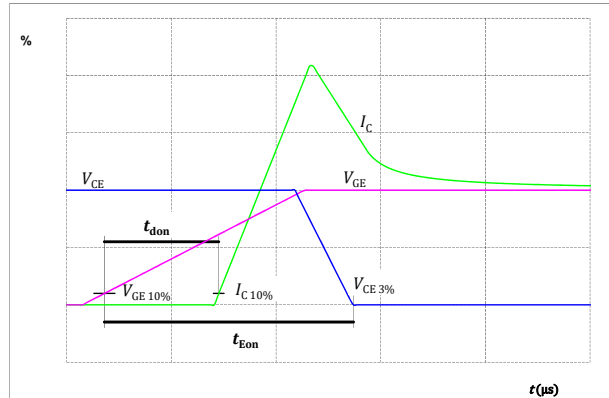

figure 52. IGBT

Turn-off Switching Waveforms & definition of t_f

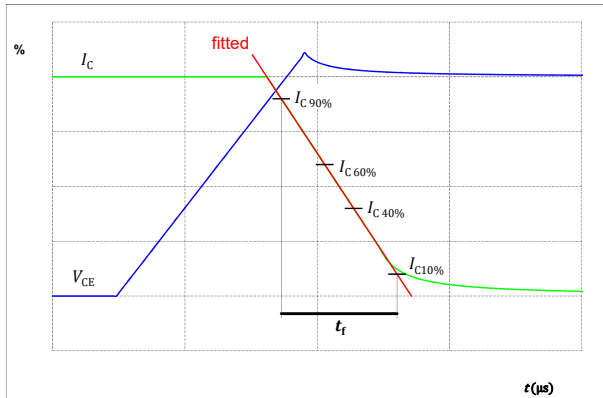
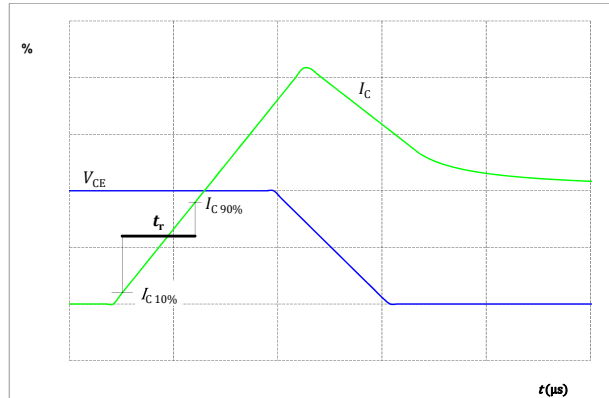

figure 53. IGBT

Turn-on Switching Waveforms & definition of t_r





Switching Definitions

figure 54. FWD

Turn-off Switching Waveforms & definition of t_{rr}

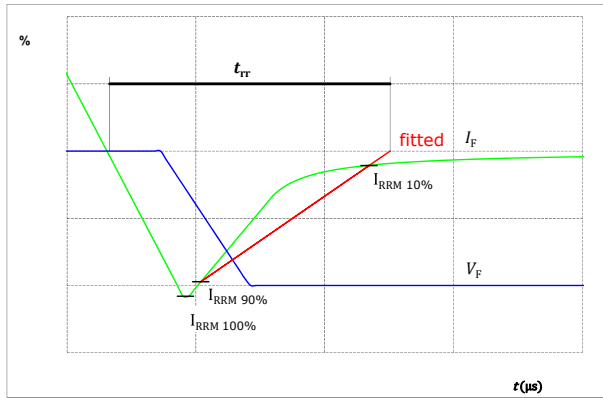
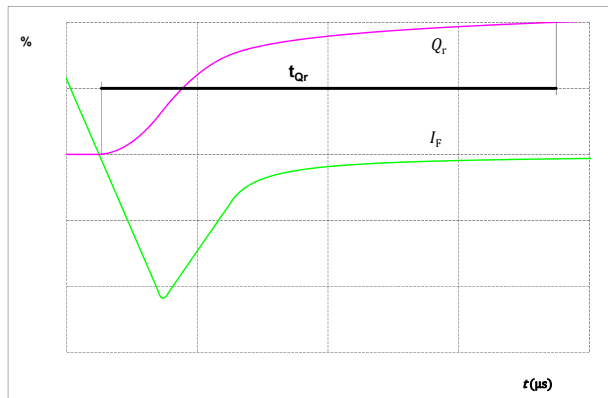

figure 55. FWD

Turn-on Switching Waveforms & definition of t_{Qr} (t_{Qr} = integrating time for Q_r)





Vincotech

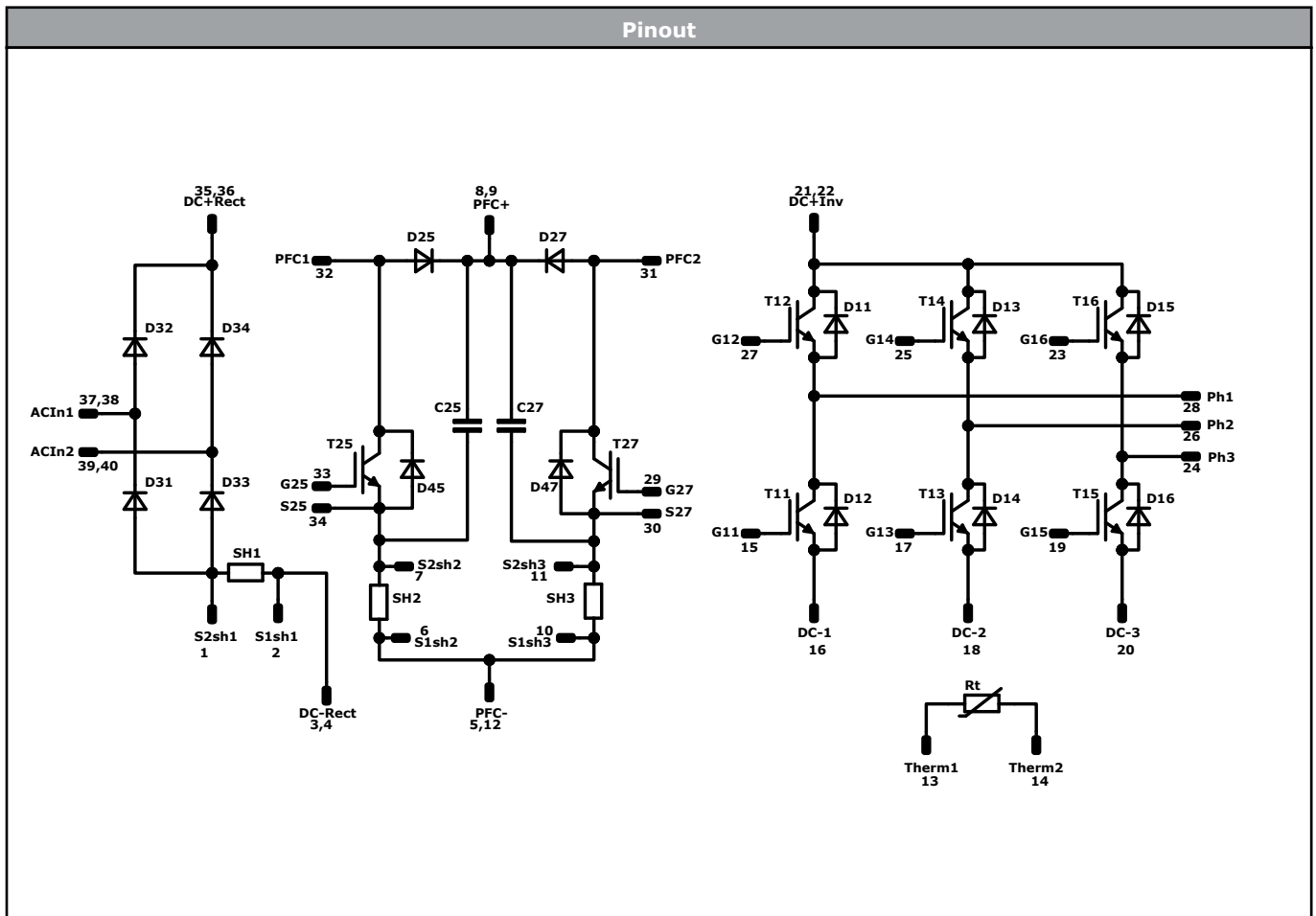

Identification					
ID	Component	Voltage	Current	Function	Comment
T11, T12, T13, T14, T15, T16	IGBT	600 V	50 A	Inverter Switch	
D11, D12, D13, D14, D15, D16	FWD	600 V	30 A	Inverter Diode	
T25, T27	IGBT	650 V	50 A	PFC Switch	
D25, D27	FWD	600 V	60 A	PFC Diode	
D45, D47	FWD	650 V	10 A	PFC Sw. Protection Diode	
D31, D32, D33, D34	Rectifier	1600 V	60 A	Rectifier Diode	
SH1	Shunt			Shunt	
SH2, SH3	Shunt			PFC Shunt	
C25, C27	Capacitor	630 V		Capacitor (PFC)	
Rt	Thermistor			Thermistor	



Packaging instruction				
Standard packaging quantity (SPQ) 100	>SPQ	Standard	<SPQ	Sample

Handling instruction
Handling instructions for <i>flow 1</i> packages see vincotech.com website.

Package data
Package data for <i>flow 1</i> packages see vincotech.com website.

Vincotech thermistor reference
See Vincotech thermistor reference table at vincotech.com website.

UL recognition and file number
This device is certified according to UL 1557 standard, UL file number E192116. For more information see vincotech.com website. 

Document No.:	Date:	Modification:	Pages
10-PG06PPA050SJ-LJ04B08T-D3-14	11 May, 2023	PFC Diode change	

DISCLAIMER

The information, specifications, procedures, methods and recommendations herein (together "information") are presented by Vincotech to reader in good faith, are believed to be accurate and reliable, but may well be incomplete and/or not applicable to all conditions or situations that may exist or occur. Vincotech reserves the right to make any changes without further notice to any products to improve reliability, function or design. No representation, guarantee or warranty is made to reader as to the accuracy, reliability or completeness of said information or that the application or use of any of the same will avoid hazards, accidents, losses, damages or injury of any kind to persons or property or that the same will not infringe third parties rights or give desired results. It is reader's sole responsibility to test and determine the suitability of the information and the product for reader's intended use.

LIFE SUPPORT POLICY

Vincotech products are not authorised for use as critical components in life support devices or systems without the express written approval of Vincotech.

As used herein:

1. Life support devices or systems are devices or systems which, (a) are intended for surgical implant into the body, or (b) support or sustain life, or (c) whose failure to perform when properly used in accordance with instructions for use provided in labelling can be reasonably expected to result in significant injury to the user.
2. A critical component is any component of a life support device or system whose failure to perform can be reasonably expected to cause the failure of the life support device or system, or to affect its safety or effectiveness.