



flowNPC 2

650 V / 200 A

Topology features

- Kelvin Emitter for improved switching performance
- Temperature sensor
- Neutral Point Clamped Topology (I-Type)

Component features

- High speed and smooth switching
- Low gate charge
- Very low collector emitter saturation voltage

Housing features

- Base isolation: Al₂O₃
- Convex shaped baseplate for superior thermal contact
- Cu baseplate
- Thermo-mechanical push-and-pull force relief
- Solder pin

Target applications

- UPS

Types

- 30-FT07NIB200S502-LE04F58

flow 2 13 mm housing

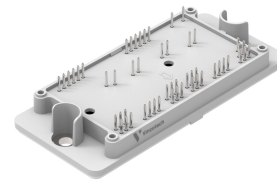

Schematic

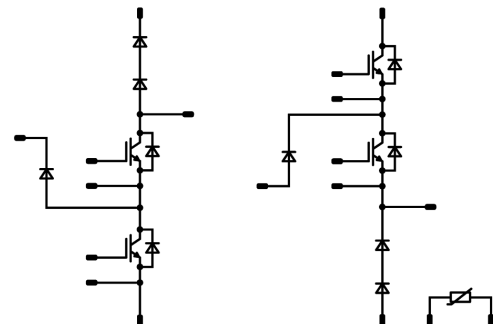

**Maximum Ratings** $T_j = 25\text{ °C}$, unless otherwise specified

Parameter	Symbol	Conditions	Value	Unit
Buck Switch				
Collector-emitter voltage	V_{CES}		650	V
Collector current (DC current)	I_C	$T_j = T_{jmax}$ $T_s = 80\text{ °C}$	164	A
Repetitive peak collector current	I_{CRM}	t_p limited by T_{jmax}	600	A
Total power dissipation	P_{tot}	$T_j = T_{jmax}$ $T_s = 80\text{ °C}$	236	W
Gate-emitter voltage	V_{GES}		± 20	V
Maximum junction temperature	T_{jmax}		175	°C
Buck Diode				
Peak repetitive reverse voltage	V_{RRM}		650	V
Forward current (DC current)	I_F	$T_j = T_{jmax}$ $T_s = 80\text{ °C}$	148	A
Repetitive peak forward current	I_{FRM}	t_p limited by T_{jmax}	400	A
Total power dissipation	P_{tot}	$T_j = T_{jmax}$ $T_s = 80\text{ °C}$	186	W
Maximum junction temperature	T_{jmax}		175	°C
Buck Sw. Protection Diode				
Peak repetitive reverse voltage	V_{RRM}		650	V
Forward current (DC current)	I_F	$T_j = T_{jmax}$ $T_s = 80\text{ °C}$	36	A
Repetitive peak forward current	I_{FRM}	t_p limited by T_{jmax}	60	A
Total power dissipation	P_{tot}	$T_j = T_{jmax}$ $T_s = 80\text{ °C}$	59	W
Maximum junction temperature	T_{jmax}		175	°C



Vincotech

Maximum Ratings

$T_j = 25\text{ °C}$, unless otherwise specified

Parameter	Symbol	Conditions	Value	Unit
-----------	--------	------------	-------	------

Boost Switch

Collector-emitter voltage	V_{CES}		650	V
Collector current (DC current)	I_C	$T_j = T_{jmax}$ $T_s = 80\text{ °C}$	164	A
Repetitive peak collector current	I_{CRM}	t_p limited by T_{jmax}	600	A
Total power dissipation	P_{tot}	$T_j = T_{jmax}$ $T_s = 80\text{ °C}$	236	W
Gate-emitter voltage	V_{GES}		± 20	V
Maximum junction temperature	T_{jmax}		175	°C

Boost Diode

Peak repetitive reverse voltage	V_{RRM}		1300	V
Forward current (DC current)	I_F	$T_j = T_{jmax}$ $T_s = 80\text{ °C}$	142	A
Repetitive peak forward current	I_{FRM}	t_p limited by T_{jmax}	400	A
Total power dissipation	P_{tot}	$T_j = T_{jmax}$ $T_s = 80\text{ °C}$	374	W
Maximum junction temperature	T_{jmax}		175	°C

Boost Sw. Protection Diode

Peak repetitive reverse voltage	V_{RRM}		650	V
Forward current (DC current)	I_F	$T_j = T_{jmax}$ $T_s = 80\text{ °C}$	36	A
Repetitive peak forward current	I_{FRM}	t_p limited by T_{jmax}	60	A
Total power dissipation	P_{tot}	$T_j = T_{jmax}$ $T_s = 80\text{ °C}$	59	W
Maximum junction temperature	T_{jmax}		175	°C



Maximum Ratings

$T_j = 25\text{ °C}$, unless otherwise specified

Parameter	Symbol	Conditions	Value	Unit
-----------	--------	------------	-------	------

Module Properties

Thermal Properties

Storage temperature	T_{stg}		-40...+125	°C
Operation temperature under switching condition	T_{jop}		-40...+($T_{jmax} - 25$)	°C

Isolation Properties

Isolation voltage	V_{isol}	DC Test Voltage* $t_p = 2\text{ s}$	6000	V
Isolation voltage	V_{isol}	AC Voltage $t_p = 1\text{ min}$	2500	V
Creepage distance			>12,7	mm
Clearance			>12,7	mm
Comparative Tracking Index	CTI		≥ 200	

*100 % tested in production



Vincotech

30-FT07NIB200S502-LE04F58
datasheet

Characteristic Values

Parameter	Symbol	Conditions					Values			Unit
		V_{GS} [V]	V_{GE} [V]	V_{DS} [V]	I_D [A]	T_j [°C]	Min	Typ	Max	

Buck Switch

Static

Gate-emitter threshold voltage	$V_{GE(th)}$	$V_{CE} = V_{GE}$			0,002	25	3,2	4	4,8	V
Collector-emitter saturation voltage	$V_{CE(sat)}$		15		200	25 125 150		1,39 1,48 1,51	1,75 ⁽¹⁾	V
Collector-emitter cut-off current	I_{CES}		0	650		25			200	μA
Gate-emitter leakage current	I_{GES}		20	0		25			400	nA
Internal gate resistance	r_g							None		Ω
Input capacitance	C_{ies}							12400		pF
Output capacitance	C_{oes}	$f = 1$ Mhz	0	25		25		352		pF
Reverse transfer capacitance	C_{res}							48		pF
Gate charge	Q_g	$V_{CC} = 520$ V	15		200	25		480		nC

Thermal

Thermal resistance junction to sink ⁽²⁾	$R_{th(j-s)}$	$\lambda_{paste} = 3,4$ W/mK (PSX)						0,4		K/W
--	---------------	------------------------------------	--	--	--	--	--	-----	--	-----

Dynamic

Turn-on delay time	$t_{d(on)}$	$R_{gon} = 2 \Omega$ $R_{goff} = 2 \Omega$	-5/15	350	120	25		50		ns
						125		50,5		
						150		51		
Rise time	t_r					25		8		
						125		8,5		
						150		8,5		
Turn-off delay time	$t_{d(off)}$					25		155		
		125		182						
		150		189						
Fall time	t_f	25		8,9						
		125		13,54						
		150		17,2						
Turn-on energy (per pulse)	E_{on}	$Q_{tFWD} = 4,45 \mu C$				25		1,42		mWs
		$Q_{tFWD} = 8,82 \mu C$				125		2,13		
		$Q_{tFWD} = 10,08 \mu C$				150		2,22		
Turn-off energy (per pulse)	E_{off}					25		1,14		mWs
						125		1,95		
						150		2,16		



Vincotech

Characteristic Values

Parameter	Symbol	Conditions					Values			Unit
		V_{GE} [V] V_{GS} [V]	V_{CE} [V] V_{DS} [V] V_F [V]	I_C [A] I_D [A] I_F [A]	T_j [°C]	Min	Typ	Max		

Buck Diode

Static

Forward voltage	V_F				200	25 125 150		1,5 1,44 1,42	1,92 ⁽¹⁾	V
Reverse leakage current	I_R	$V_r = 650$ V				25			10,6	μA

Thermal

Thermal resistance junction to sink ⁽²⁾	$R_{th(j-s)}$	$\lambda_{paste} = 3,4$ W/mK (PSX)						0,51		K/W
--	---------------	---------------------------------------	--	--	--	--	--	------	--	-----

Dynamic

Peak recovery current	I_{RM}					25 125 150		175,24 234,95 251,15		A
Reverse recovery time	t_{rr}					25 125 150		44,56 65,22 71,8		ns
Recovered charge	Q_r	$di/dt=13388$ A/μs $di/dt=12775$ A/μs $di/dt=14167$ A/μs	-5/15	350	120	25 125 150		4,45 8,82 10,08		μC
Reverse recovered energy	E_{rec}					25 125 150		0,726 1,76 2,11		mWs
Peak rate of fall of recovery current	$(di_r/dt)_{max}$					25 125 150		6361 4385 4770		A/μs



Vincotech

30-FT07NIB200S502-LE04F58
datasheet

Characteristic Values

Parameter	Symbol	Conditions					Values			Unit
		V_{GS} [V]	V_{GE} [V]	V_{DS} [V]	V_{CE} [V]	T_j [°C]	Min	Typ	Max	

Buck Sw. Protection Diode

Static

Forward voltage	V_F				30	25 125	1,23	1,7 1,59	1,87 ⁽¹⁾	V
Reverse leakage current	I_R	$V_i = 650$ V				25			0,36	μ A

Thermal

Thermal resistance junction to sink ⁽²⁾	$R_{th(j-s)}$	$\lambda_{paste} = 3,4$ W/mK (PSX)						1,61		K/W
--	---------------	---------------------------------------	--	--	--	--	--	------	--	-----



Vincotech

Characteristic Values

Parameter	Symbol	Conditions					Values			Unit
		V_{GS} [V]	V_{GE} [V]	V_{DS} [V]	V_F [V]	I_C [A] I_D [A] I_F [A]	T_j [°C]	Min	Typ	

Boost Switch

Static

Gate-emitter threshold voltage	$V_{GE(th)}$	$V_{CE} = V_{GE}$				0,002	25	3,2	4	4,8	V
Collector-emitter saturation voltage	$V_{CE(sat)}$		15		200		25 125 150		1,39 1,48 1,51	1,75 ⁽¹⁾	V
Collector-emitter cut-off current	I_{CES}		0	650			25			200	μA
Gate-emitter leakage current	I_{GES}		20	0			25			400	nA
Internal gate resistance	r_g								None		Ω
Input capacitance	C_{ies}								12400		pF
Output capacitance	C_{oes}	$f = 1$ Mhz	0	25			25		352		pF
Reverse transfer capacitance	C_{res}								48		pF
Gate charge	Q_g	$V_{CC} = 520$ V	15		200		25		480		nC

Thermal

Thermal resistance junction to sink ⁽²⁾	$R_{th(j-s)}$	$\lambda_{paste} = 3,4$ W/mK (PSX)							0,4		K/W
--	---------------	---------------------------------------	--	--	--	--	--	--	-----	--	-----

Dynamic

Turn-on delay time	$t_{d(on)}$						25 125 150		58,5 50,5 57,5		ns
Rise time	t_r						25 125 150		7 8 8,5		ns
Turn-off delay time	$t_{d(off)}$						25 125 150		154,5 182,5 188,5		ns
Fall time	t_f						25 125 150		9,48 15,41 18,94		ns
Turn-on energy (per pulse)	E_{on}	$Q_{tFWD} = 4,85$ μC $Q_{tFWD} = 9,35$ μC $Q_{tFWD} = 10,9$ μC					25 125 150		1,28 2,19 2,24		mWs
Turn-off energy (per pulse)	E_{off}						25 125 150		1,15 1,99 2,24		mWs



Vincotech

Characteristic Values

Parameter	Symbol	Conditions					Values			Unit
		V_{GE} [V] V_{GS} [V]	V_{CE} [V] V_{DS} [V] V_F [V]	I_C [A] I_D [A] I_F [A]	T_j [°C]	Min	Typ	Max		
Boost Diode										
Static										
Forward voltage	V_F			200	25 125 150		3,37 3,14 3,04	3,84 ⁽¹⁾		V
Reverse leakage current	I_R	$V_r = 1300$ V			25			10,6		μA
Thermal										
Thermal resistance junction to sink ⁽²⁾	$R_{th(j-s)}$	$\lambda_{paste} = 3,4$ W/mK (PSX)					0,25			K/W
Dynamic										
Peak recovery current	I_{RM}				25 125 150		144,9 195,79 209,45			A
Reverse recovery time	t_{rr}				25 125 150		86,68 114,65 130,2			ns
Recovered charge	Q_r	$di/dt=14933$ A/μs $di/dt=12780$ A/μs $di/dt=13600$ A/μs	-5/15	350	120	25 125 150	4,85 9,35 10,9			μC
Reverse recovered energy	E_{rec}				25 125 150		1,04 2,21 2,6			mWs
Peak rate of fall of recovery current	$(di_r/dt)_{max}$				25 125 150		12289 7167 6631			A/μs



Characteristic Values

Parameter	Symbol	Conditions					Values			Unit
		V_{GS} [V]	V_{GE} [V]	V_{DS} [V]	V_{CE} [V]	T_j [°C]	Min	Typ	Max	

Boost Sw. Protection Diode

Static

Forward voltage	V_F				30	25 125	1,23	1,7 1,59	1,87 ⁽¹⁾	V
Reverse leakage current	I_R	$V_i = 650$ V				25			0,36	μA

Thermal

Thermal resistance junction to sink ⁽²⁾	$R_{th(j-s)}$	$\lambda_{paste} = 3,4$ W/mK (PSX)						1,61		K/W
--	---------------	---------------------------------------	--	--	--	--	--	------	--	-----

Thermistor

Static

Rated resistance	R					25		22		kΩ
Deviation of R100	$\Delta_{R/R}$	$R_{100} = 1484$ Ω				100	-5		5	%
Power dissipation	P					25		130		mW
Power dissipation constant	d					25		1,5		mW/K
B-value	$B_{(25/50)}$	Tol. ±1 %						3962		K
B-value	$B_{(25/100)}$	Tol. ±1 %						4000		K
Vincotech Thermistor Reference									I	

⁽¹⁾ Value at chip level

⁽²⁾ Only valid with pre-applied Vincotech thermal interface material.



Buck Switch Characteristics

figure 1. IGBT

Typical output characteristics

$$I_C = f(V_{CE})$$

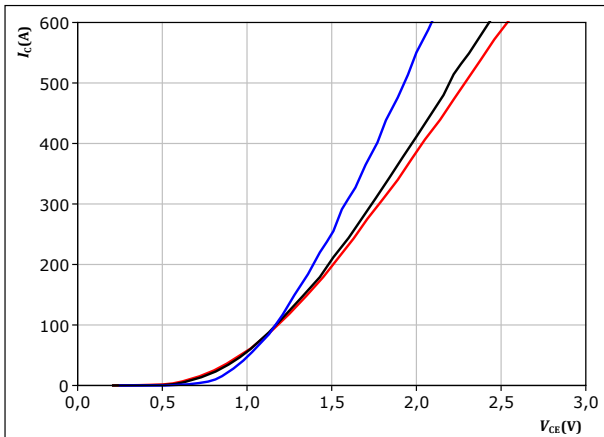

$t_p = 250 \mu s$
 $V_{GE} = 15 V$

T_j : 25 °C (blue), 125 °C (black), 150 °C (red)

figure 2. IGBT

Typical output characteristics

$$I_C = f(V_{CE})$$

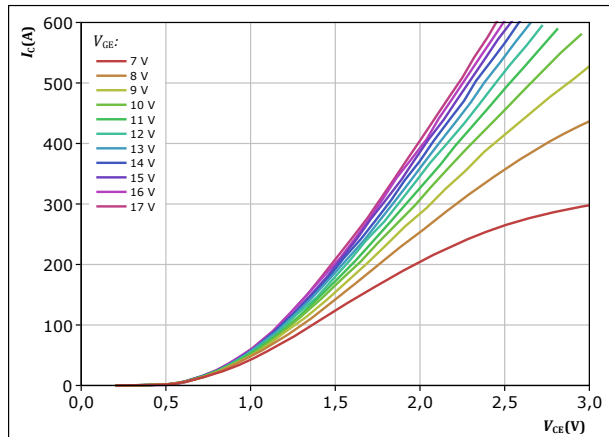

$t_p = 250 \mu s$
 $T_j = 150 \text{ °C}$
 V_{GE} from 7 V to 17 V in steps of 1 V

figure 3. IGBT

Typical transfer characteristics

$$I_C = f(V_{GE})$$

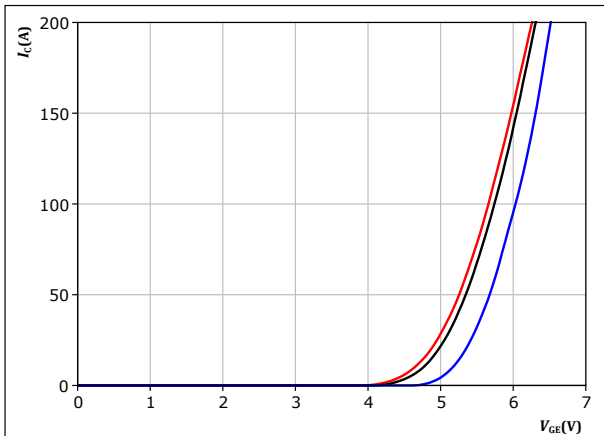

$t_p = 250 \mu s$
 $V_{CE} = 10 V$

T_j : 25 °C (blue), 125 °C (black), 150 °C (red)

figure 4. IGBT

Transient thermal impedance as a function of pulse width

$$Z_{th(j-s)} = f(t_p)$$

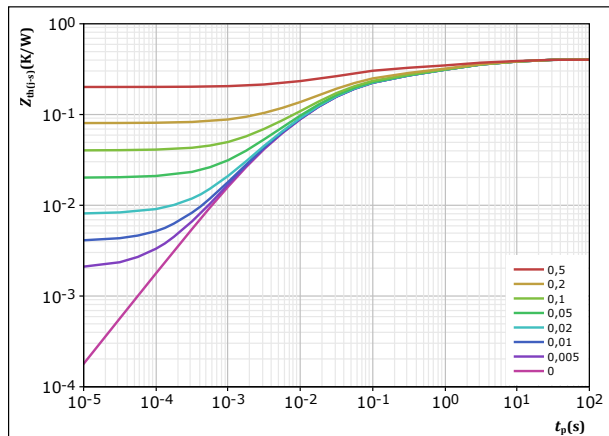

$D = t_p / T$
 $R_{th(j-s)} = 0,402 \text{ K/W}$

IGBT thermal model values

R (K/W)	τ (s)
5,60E-02	8,91E+00
9,21E-02	1,22E+00
7,03E-02	1,44E-01
1,40E-01	2,68E-02
3,76E-02	4,52E-03
6,37E-03	1,66E-03



Buck Switch Characteristics

figure 5. IGBT

Safe operating area

$I_C = f(V_{CE})$

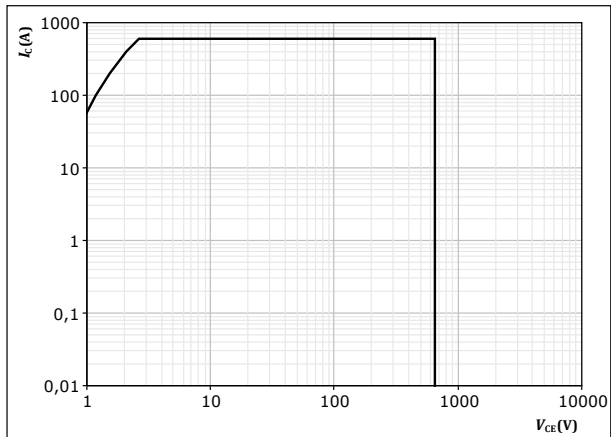

D = single pulse
T_s = 80 °C
V_{CE} = 15 V
T_j = T_{jmax}



Buck Diode Characteristics

figure 6. FWD

Typical forward characteristics

$$I_F = f(V_F)$$

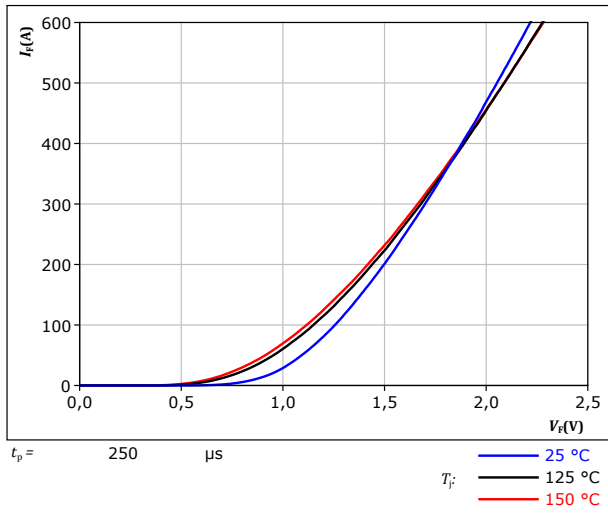
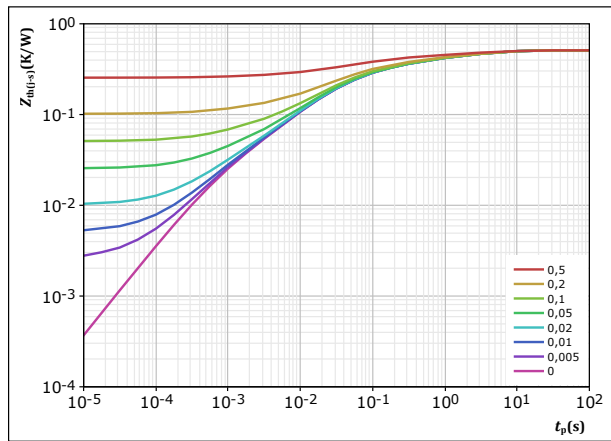

figure 7. FWD

Transient thermal impedance as a function of pulse width

$$Z_{th(j-s)} = f(t_p)$$



$D = \frac{t_p}{T}$
 $R_{th(j-s)} = 0,51 \text{ K/W}$
 FWD thermal model values

R (K/W)	τ (s)
8,05E-02	4,81E+00
1,12E-01	6,43E-01
1,62E-01	7,87E-02
1,15E-01	1,87E-02
2,73E-02	3,44E-03
1,29E-02	6,21E-04



Buck Sw. Protection Diode Characteristics

figure 8. FWD

Typical forward characteristics

$$I_F = f(V_F)$$

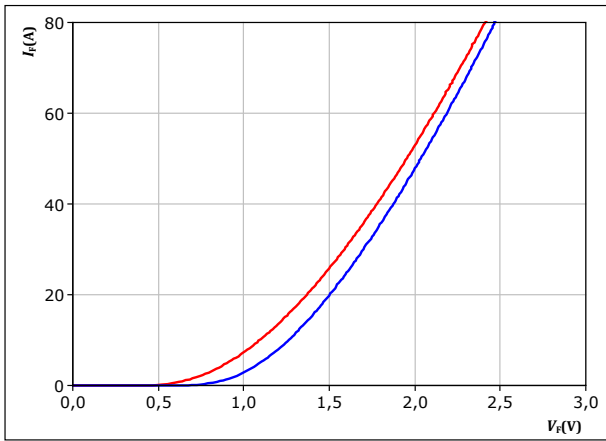

$t_p = 250\ \mu\text{s}$
 T_j : — 25 °C
 — 125 °C

figure 9. FWD

Transient thermal impedance as a function of pulse width

$$Z_{th(j-s)} = f(t_p)$$

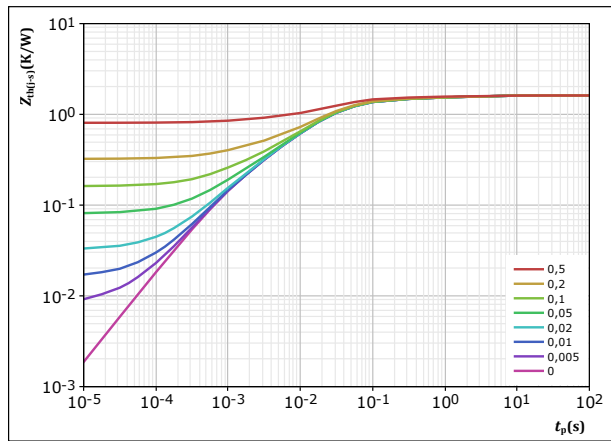

$D = t_p / T$
 $R_{th(j-s)} = 1,614\ \text{K/W}$
 FWD thermal model values

R (K/W)	τ (s)
1,05E-01	3,05E+00
1,86E-01	2,04E-01
8,60E-01	3,00E-02
3,40E-01	8,15E-03
1,24E-01	1,07E-03



Boost Switch Characteristics

figure 10. IGBT

Typical output characteristics

$I_C = f(V_{CE})$

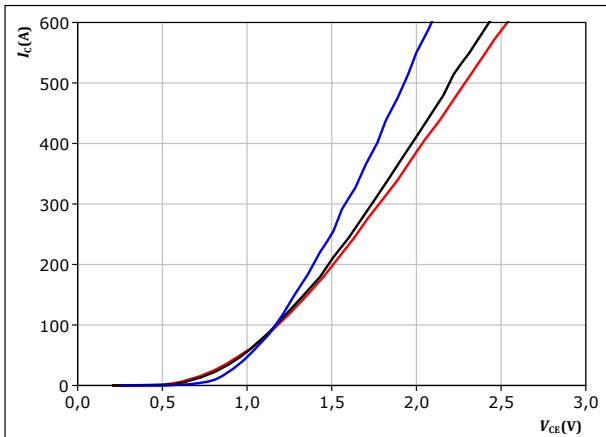

$t_p = 250 \mu s$
 $V_{GE} = 15 V$
 $T_j:$ 25 °C (blue), 125 °C (black), 150 °C (red)

figure 11. IGBT

Typical output characteristics

$I_C = f(V_{CE})$

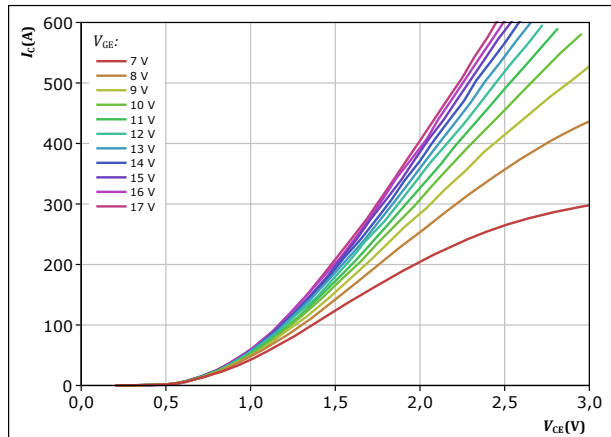

$t_p = 250 \mu s$
 $T_j = 150 \text{ °C}$
 V_{GE} from 7 V to 17 V in steps of 1 V

figure 12. IGBT

Typical transfer characteristics

$I_C = f(V_{GE})$

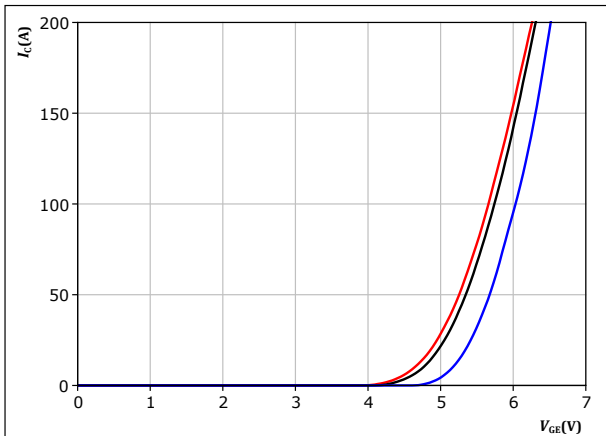

$t_p = 250 \mu s$
 $V_{CE} = 10 V$
 $T_j:$ 25 °C (blue), 125 °C (black), 150 °C (red)

figure 13. IGBT

Transient thermal impedance as a function of pulse width

$Z_{th(j-s)} = f(t_p)$

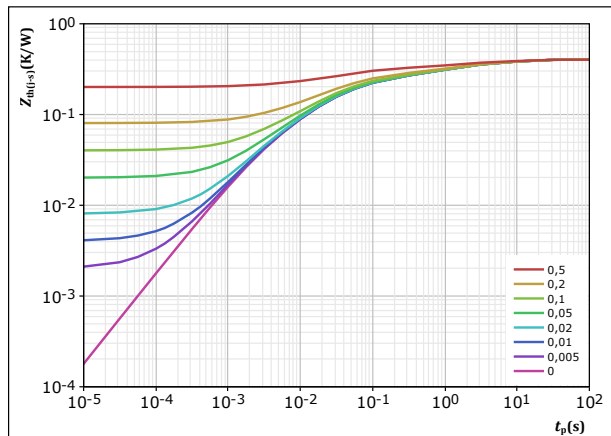

$D = t_p / T$
 $R_{th(j-s)} = 0,402 \text{ K/W}$
 IGBT thermal model values

R (K/W)	τ (s)
5,60E-02	8,91E+00
9,21E-02	1,22E+00
7,03E-02	1,44E-01
1,40E-01	2,68E-02
3,76E-02	4,52E-03
6,37E-03	1,66E-03



Boost Switch Characteristics

figure 14. IGBT

Safe operating area

$$I_C = f(V_{CE})$$

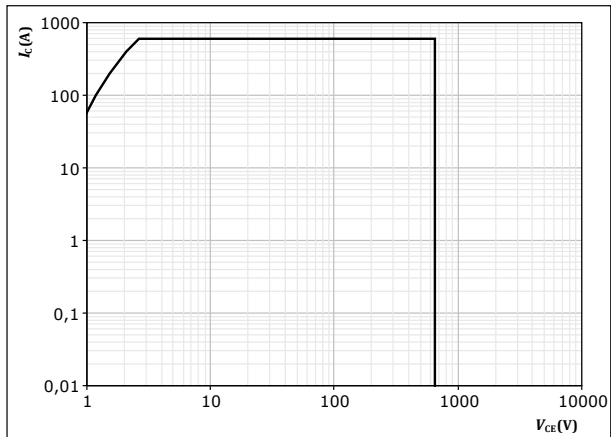

D = single pulse
T_s = 80 °C
V_{CE} = 15 V
T_j = T_{jmax}



Boost Diode Characteristics

figure 15. FWD

Typical forward characteristics

$$I_F = f(V_F)$$

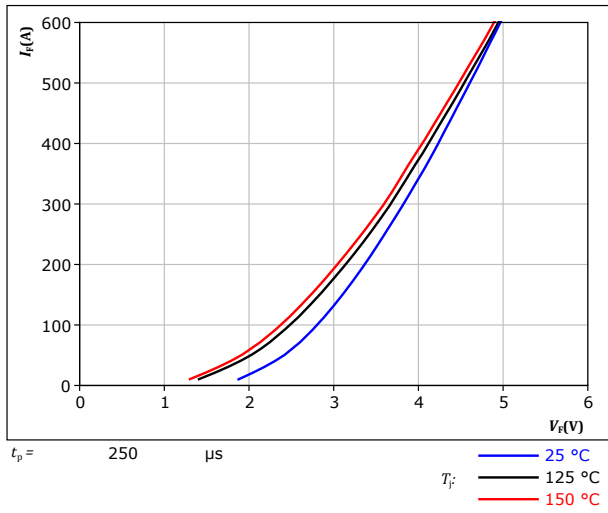
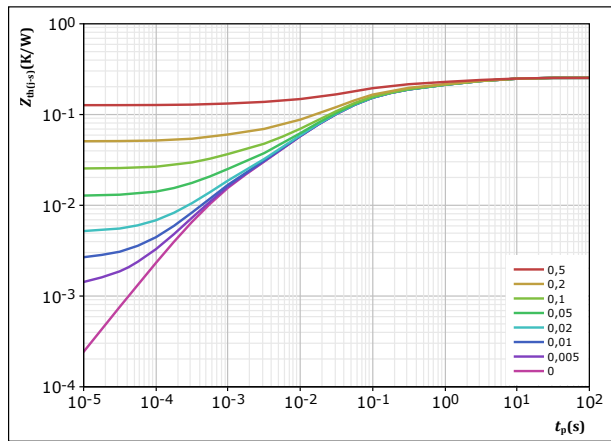

figure 16. FWD

Transient thermal impedance as a function of pulse width

$$Z_{th(j-s)} = f(t_p)$$



$$D = \frac{t_p}{T}$$

$$R_{th(j-s)} = 0,254 \text{ K/W}$$

FWD thermal model values

R (K/W)	τ (s)
2,72E-02	5,98E+00
3,88E-02	1,28E+00
5,65E-02	1,68E-01
9,22E-02	3,81E-02
2,73E-02	6,72E-03
1,17E-02	6,64E-04



Boost Sw. Protection Diode Characteristics

figure 17. FWD

Typical forward characteristics

$$I_F = f(V_F)$$

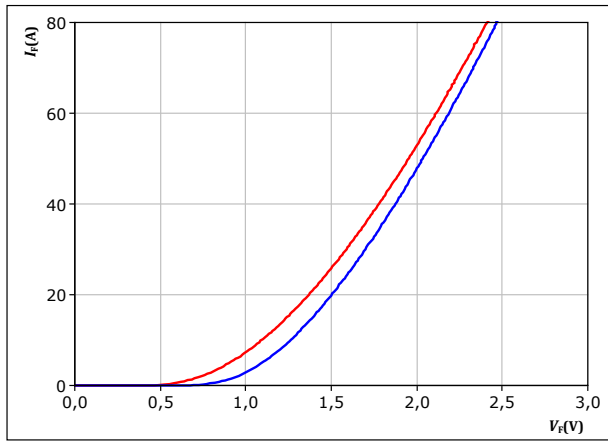

$t_p = 250 \mu s$
 $T_j: 25 \text{ }^\circ\text{C}$ (blue line), $125 \text{ }^\circ\text{C}$ (red line)

figure 18. FWD

Transient thermal impedance as a function of pulse width

$$Z_{th(j-s)} = f(t_p)$$

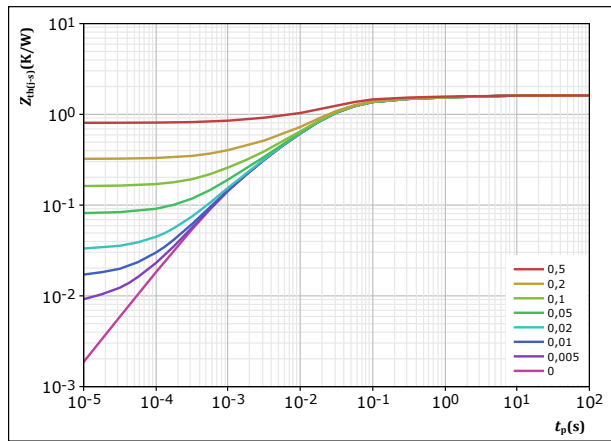

$D = t_p / T$
 $R_{th(j-s)} = 1,614 \text{ K/W}$
FWD thermal model values

R (K/W)	τ (s)
1,05E-01	3,05E+00
1,86E-01	2,04E-01
8,60E-01	3,00E-02
3,40E-01	8,15E-03
1,24E-01	1,07E-03



Thermistor Characteristics

figure 19. Thermistor

Typical NTC characteristic as function of temperature

$$R_T = f(T)$$

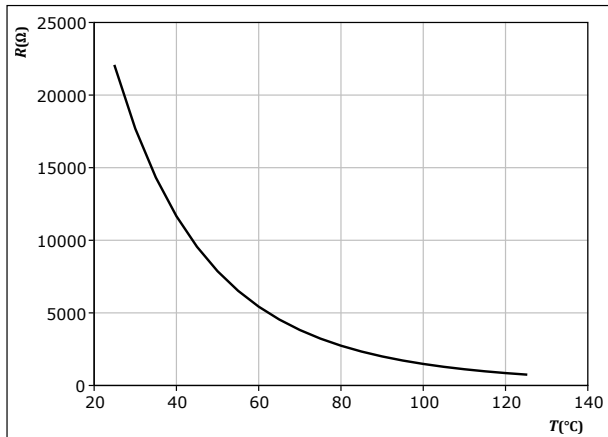



Buck Switching Characteristics

figure 20. IGBT

Typical switching energy losses as a function of collector current
 $E = f(I_c)$

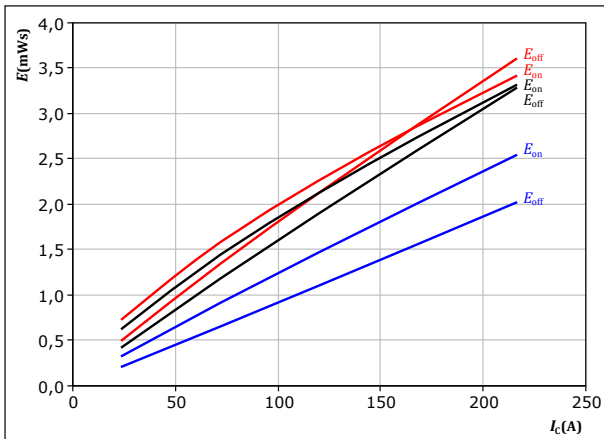

With an inductive load at

$V_{CE} =$	350	V	$T_j:$	25 °C
$V_{GE} =$	-5/15	V		125 °C
$R_{gon} =$	2	Ω		150 °C
$R_{goff} =$	2	Ω		

figure 21. IGBT

Typical switching energy losses as a function of IGBT turn on gate resistor
 $E = f(R_g)$

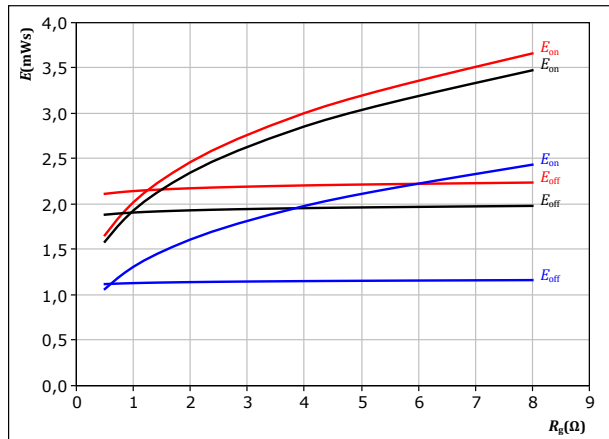

With an inductive load at

$V_{CE} =$	350	V	$T_j:$	25 °C
$V_{GE} =$	-5/15	V		125 °C
$I_c =$	120	A		150 °C

figure 22. FWD

Typical reverse recovered energy loss as a function of collector current
 $E_{rec} = f(I_c)$

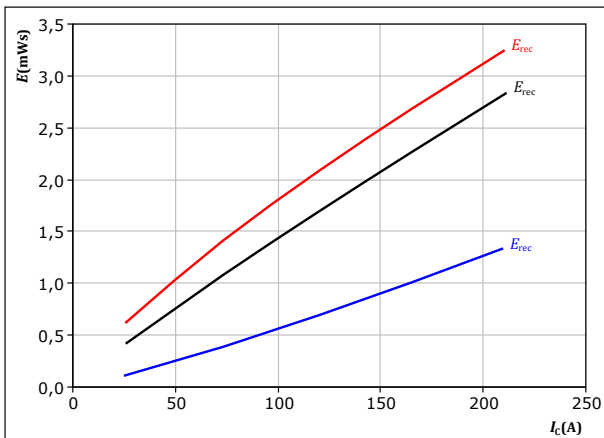

With an inductive load at

$V_{CE} =$	350	V	$T_j:$	25 °C
$V_{GE} =$	-5/15	V		125 °C
$R_{gon} =$	2	Ω		150 °C

figure 23. FWD

Typical reverse recovered energy loss as a function of IGBT turn on gate resistor
 $E_{rec} = f(R_g)$

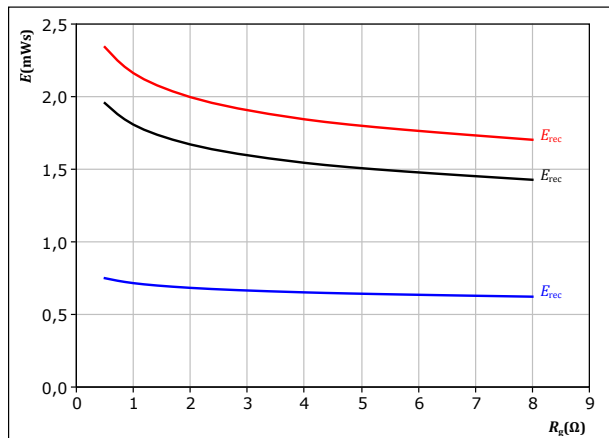

With an inductive load at

$V_{CE} =$	350	V	$T_j:$	25 °C
$V_{GE} =$	-5/15	V		125 °C
$I_c =$	120	A		150 °C



Buck Switching Characteristics

figure 24. IGBT

Typical switching times as a function of collector current
 $t = f(I_c)$

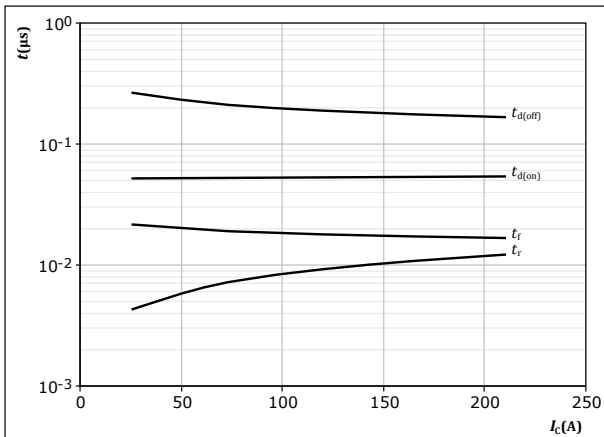

With an inductive load at
 $T_j = 150 \text{ } ^\circ\text{C}$
 $V_{CE} = 350 \text{ V}$
 $V_{GE} = -5/15 \text{ V}$
 $R_{gon} = 2 \text{ } \Omega$
 $R_{goff} = 2 \text{ } \Omega$

figure 25. IGBT

Typical switching times as a function of IGBT turn on gate resistor
 $t = f(R_g)$

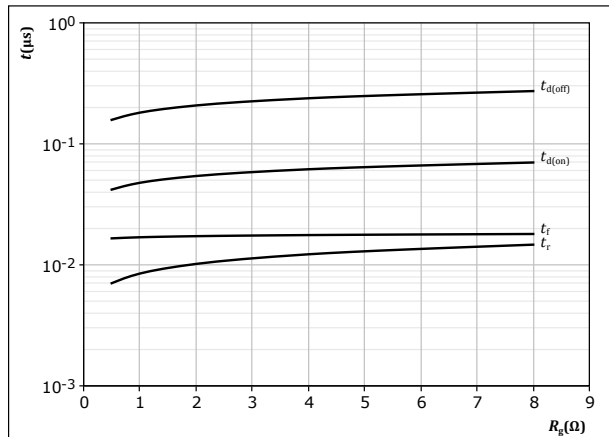

With an inductive load at
 $T_j = 150 \text{ } ^\circ\text{C}$
 $V_{CE} = 350 \text{ V}$
 $V_{GE} = -5/15 \text{ V}$
 $I_c = 120 \text{ A}$

figure 26. FWD

Typical reverse recovery time as a function of collector current
 $t_{rr} = f(I_c)$

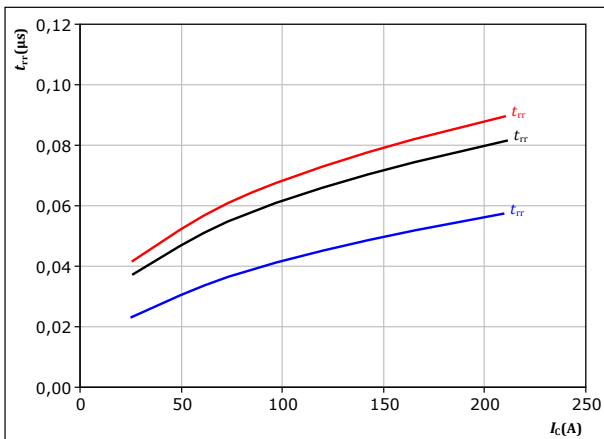

With an inductive load at
 $V_{CE} = 350 \text{ V}$
 $V_{GE} = -5/15 \text{ V}$
 $R_{gon} = 2 \text{ } \Omega$
 $T_j:$ — 25 °C
 — 125 °C
 — 150 °C

figure 27. FWD

Typical reverse recovery time as a function of IGBT turn on gate resistor
 $t_{rr} = f(R_{gon})$

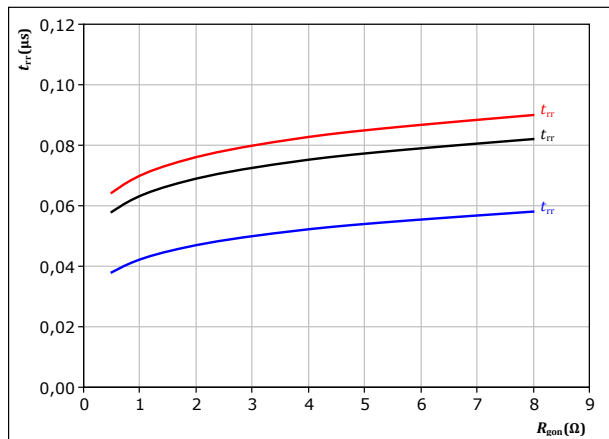

With an inductive load at
 $V_{CE} = 350 \text{ V}$
 $V_{GE} = -5/15 \text{ V}$
 $I_c = 120 \text{ A}$
 $T_j:$ — 25 °C
 — 125 °C
 — 150 °C



Buck Switching Characteristics

figure 28. FWD

Typical recovered charge as a function of collector current

$$Q_r = f(I_c)$$

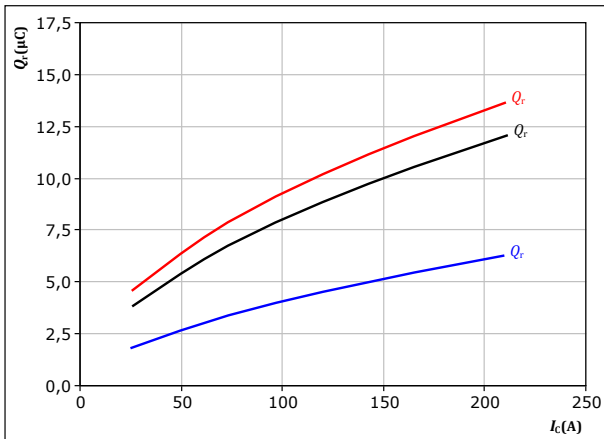

With an inductive load at

$V_{CE} = 350 \text{ V}$
 $V_{GE} = -5/15 \text{ V}$
 $R_{gon} = 2 \ \Omega$

T_j : — 25 °C
— 125 °C
— 150 °C

figure 29. FWD

Typical recovered charge as a function of IGBT turn on gate resistor

$$Q_r = f(R_{gon})$$

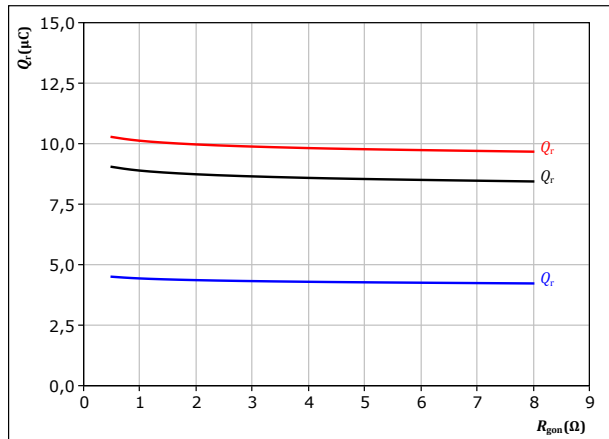

With an inductive load at

$V_{CE} = 350 \text{ V}$
 $V_{GE} = -5/15 \text{ V}$
 $I_c = 120 \text{ A}$

T_j : — 25 °C
— 125 °C
— 150 °C

figure 30. FWD

Typical peak reverse recovery current as a function of collector current

$$I_{RM} = f(I_c)$$

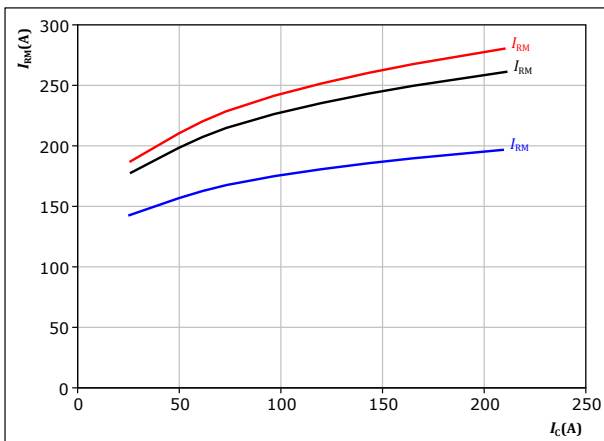

With an inductive load at

$V_{CE} = 350 \text{ V}$
 $V_{GE} = -5/15 \text{ V}$
 $R_{gon} = 2 \ \Omega$

T_j : — 25 °C
— 125 °C
— 150 °C

figure 31. FWD

Typical peak reverse recovery current as a function of IGBT turn on gate resistor

$$I_{RM} = f(R_{gon})$$

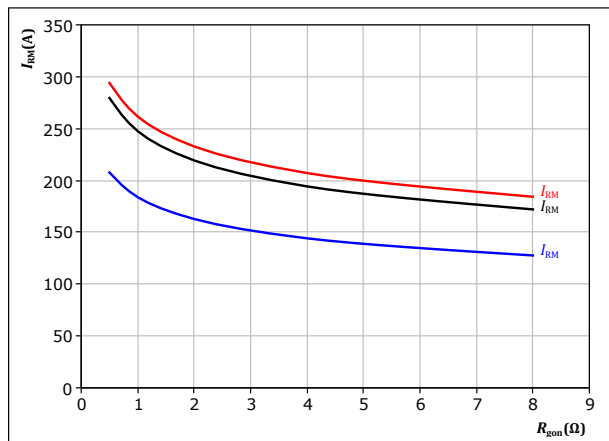

With an inductive load at

$V_{CE} = 350 \text{ V}$
 $V_{GE} = -5/15 \text{ V}$
 $I_c = 120 \text{ A}$

T_j : — 25 °C
— 125 °C
— 150 °C



Buck Switching Characteristics

figure 32. FWD

Typical rate of fall of forward and reverse recovery current as a function of collector current
 $di_f/dt, di_{rr}/dt = f(I_c)$

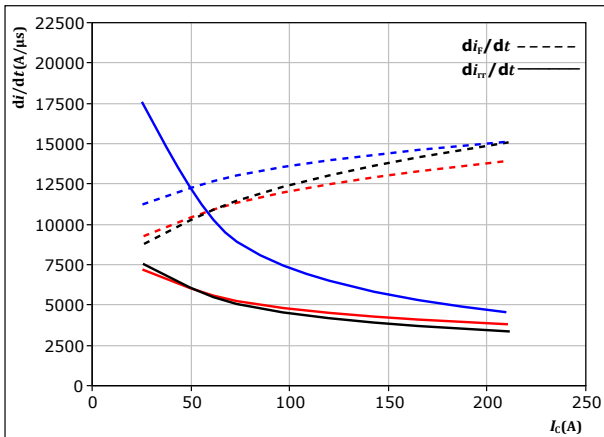

With an inductive load at

$V_{CE} = 350$ V
 $V_{GE} = -5/15$ V
 $R_{gon} = 2$ Ω

T_j : — 25 °C
 — 125 °C
 — 150 °C

figure 33. FWD

Typical rate of fall of forward and reverse recovery current as a function of turn on gate resistor
 $di_f/dt, di_{rr}/dt = f(R_{gon})$

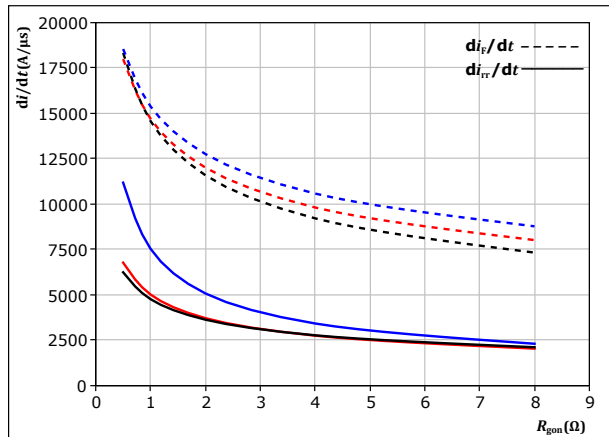

With an inductive load at

$V_{CE} = 350$ V
 $V_{GE} = -5/15$ V
 $I_c = 120$ A

T_j : — 25 °C
 — 125 °C
 — 150 °C

figure 34. IGBT

Reverse bias safe operating area

$I_c = f(V_{CE})$

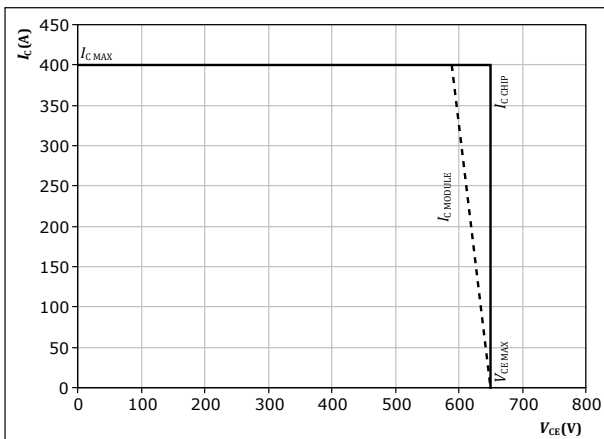

At $T_j = 150$ °C
 $R_{gon} = 2$ Ω
 $R_{goff} = 2$ Ω



Boost Switching Characteristics

figure 35. IGBT

Typical switching energy losses as a function of collector current
 $E = f(I_c)$

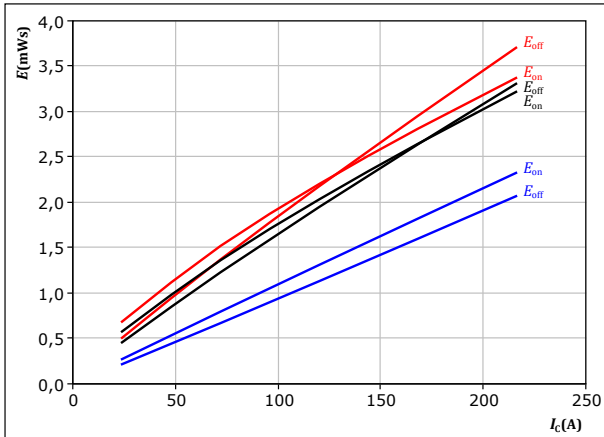

With an inductive load at
 $V_{CE} = 350$ V
 $V_{GE} = -5/15$ V
 $R_{gon} = 2$ Ω
 $R_{goff} = 2$ Ω

T_j : — 25 °C
 — 125 °C
 — 150 °C

figure 36. IGBT

Typical switching energy losses as a function of IGBT turn on gate resistor
 $E = f(R_g)$

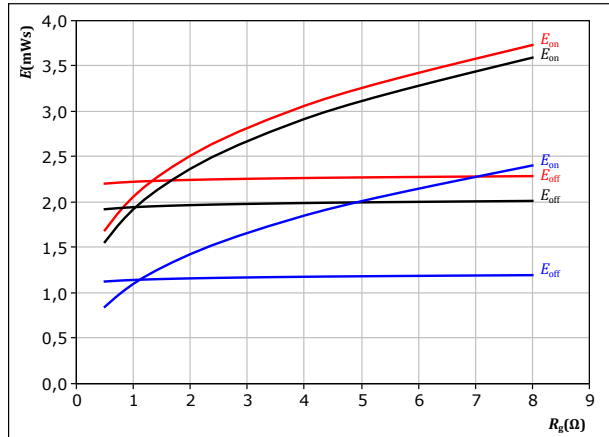

With an inductive load at
 $V_{CE} = 350$ V
 $V_{GE} = -5/15$ V
 $I_c = 120$ A

T_j : — 25 °C
 — 125 °C
 — 150 °C

figure 37. FWD

Typical reverse recovered energy loss as a function of collector current
 $E_{rec} = f(I_c)$

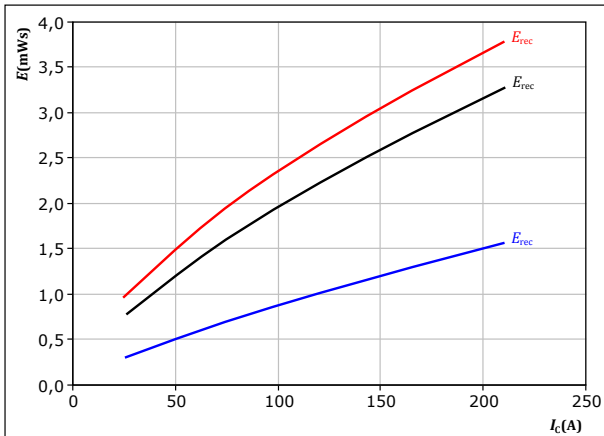

With an inductive load at
 $V_{CE} = 350$ V
 $V_{GE} = -5/15$ V
 $R_{gon} = 2$ Ω

T_j : — 25 °C
 — 125 °C
 — 150 °C

figure 38. FWD

Typical reverse recovered energy loss as a function of IGBT turn on gate resistor
 $E_{rec} = f(R_g)$

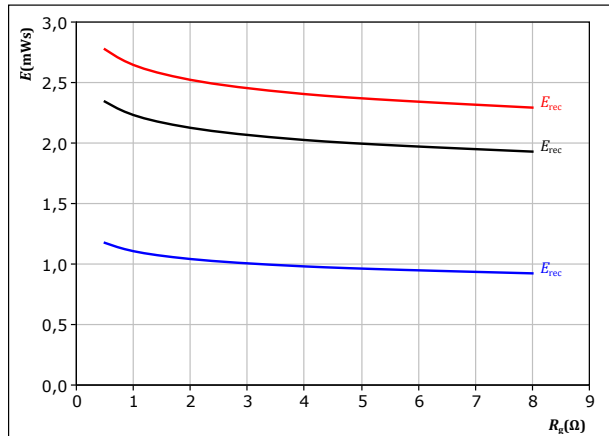

With an inductive load at
 $V_{CE} = 350$ V
 $V_{GE} = -5/15$ V
 $I_c = 120$ A

T_j : — 25 °C
 — 125 °C
 — 150 °C



Boost Switching Characteristics

figure 39. IGBT

Typical switching times as a function of collector current
 $t = f(I_c)$

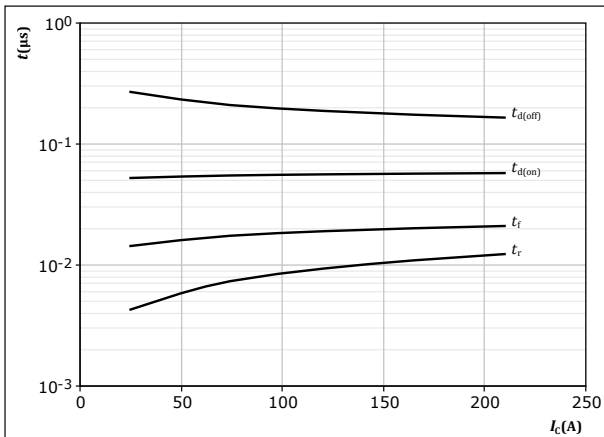

With an inductive load at
 $T_j = 150 \text{ } ^\circ\text{C}$
 $V_{CE} = 350 \text{ V}$
 $V_{GE} = -5/15 \text{ V}$
 $R_{gon} = 2 \text{ } \Omega$
 $R_{goff} = 2 \text{ } \Omega$

figure 40. IGBT

Typical switching times as a function of IGBT turn on gate resistor
 $t = f(R_g)$

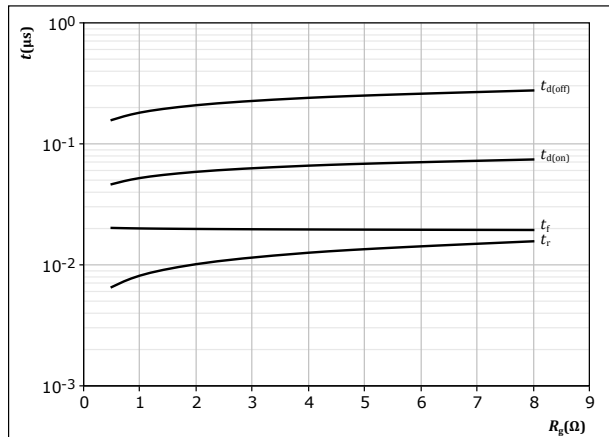

With an inductive load at
 $T_j = 150 \text{ } ^\circ\text{C}$
 $V_{CE} = 350 \text{ V}$
 $V_{GE} = -5/15 \text{ V}$
 $I_c = 120 \text{ A}$

figure 41. FWD

Typical reverse recovery time as a function of collector current
 $t_{rr} = f(I_c)$

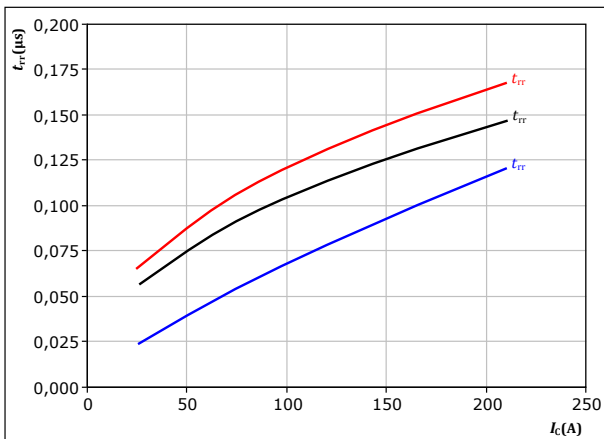

With an inductive load at
 $V_{CE} = 350 \text{ V}$
 $V_{GE} = -5/15 \text{ V}$
 $R_{gon} = 2 \text{ } \Omega$
 $T_j:$ — 25 °C
 — 125 °C
 — 150 °C

figure 42. FWD

Typical reverse recovery time as a function of IGBT turn on gate resistor
 $t_{rr} = f(R_{gon})$

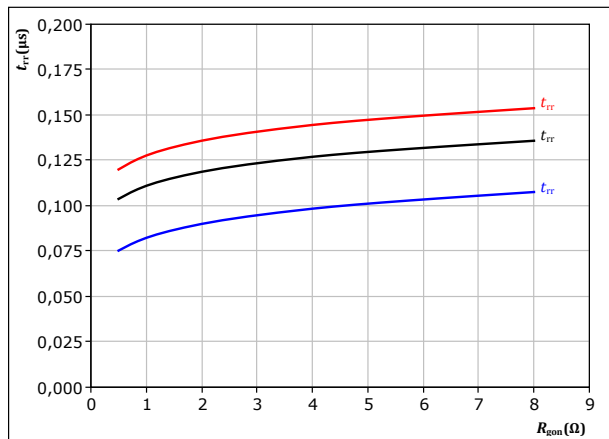

With an inductive load at
 $V_{CE} = 350 \text{ V}$
 $V_{GE} = -5/15 \text{ V}$
 $I_c = 120 \text{ A}$
 $T_j:$ — 25 °C
 — 125 °C
 — 150 °C



Boost Switching Characteristics

figure 43. FWD

Typical recovered charge as a function of collector current

$$Q_r = f(I_c)$$

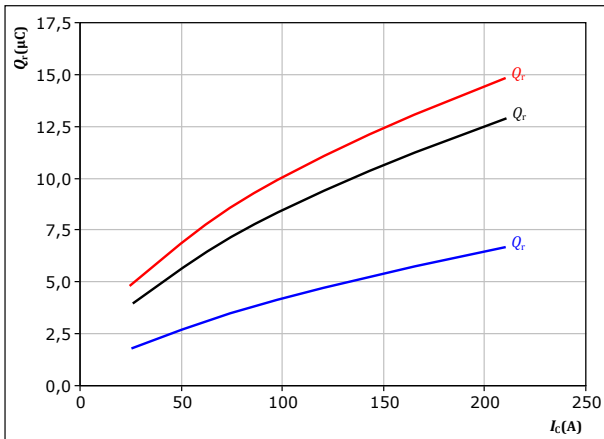

With an inductive load at

$V_{CE} = 350 \text{ V}$
 $V_{GE} = -5/15 \text{ V}$
 $R_{gon} = 2 \ \Omega$

T_j : — 25 °C
— 125 °C
— 150 °C

figure 44. FWD

Typical recovered charge as a function of IGBT turn on gate resistor

$$Q_r = f(R_{gon})$$

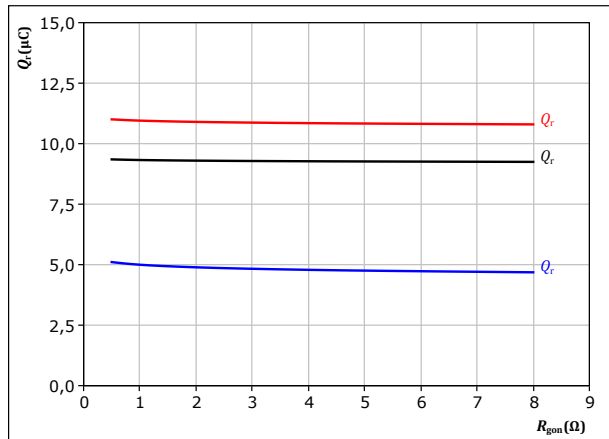

With an inductive load at

$V_{CE} = 350 \text{ V}$
 $V_{GE} = -5/15 \text{ V}$
 $I_c = 120 \text{ A}$

T_j : — 25 °C
— 125 °C
— 150 °C

figure 45. FWD

Typical peak reverse recovery current as a function of collector current

$$I_{RM} = f(I_c)$$

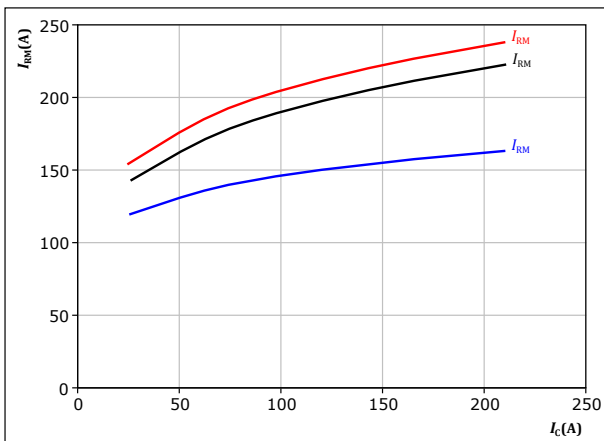

With an inductive load at

$V_{CE} = 350 \text{ V}$
 $V_{GE} = -5/15 \text{ V}$
 $R_{gon} = 2 \ \Omega$

T_j : — 25 °C
— 125 °C
— 150 °C

figure 46. FWD

Typical peak reverse recovery current as a function of IGBT turn on gate resistor

$$I_{RM} = f(R_{gon})$$

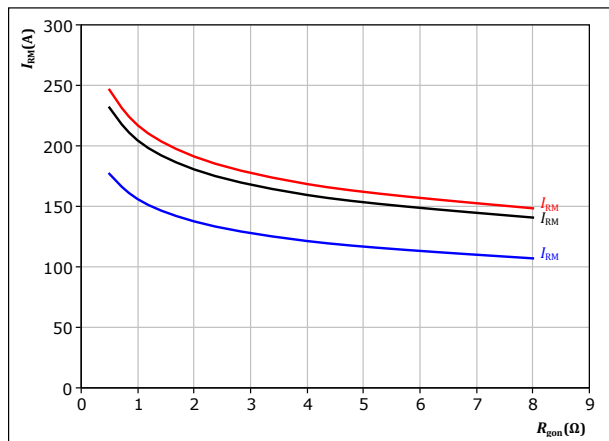

With an inductive load at

$V_{CE} = 350 \text{ V}$
 $V_{GE} = -5/15 \text{ V}$
 $I_c = 120 \text{ A}$

T_j : — 25 °C
— 125 °C
— 150 °C



Boost Switching Characteristics

figure 47. FWD

Typical rate of fall of forward and reverse recovery current as a function of collector current
 $di_f/dt, di_{rr}/dt = f(I_c)$

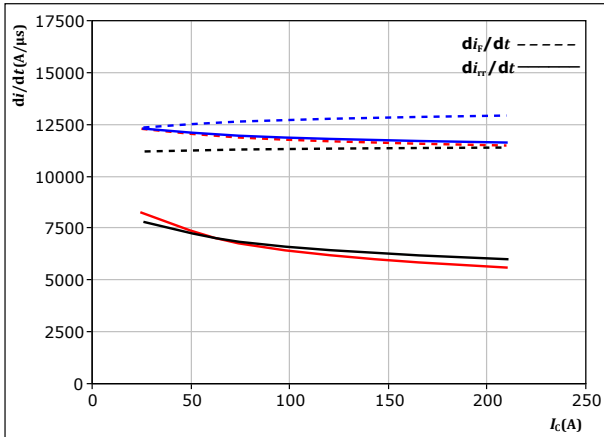

With an inductive load at

$V_{CE} = 350$ V
 $V_{GE} = -5/15$ V
 $R_{gon} = 2$ Ω

T_j : — 25 °C
 — 125 °C
 — 150 °C

figure 48. FWD

Typical rate of fall of forward and reverse recovery current as a function of turn on gate resistor
 $di_f/dt, di_{rr}/dt = f(R_{gon})$

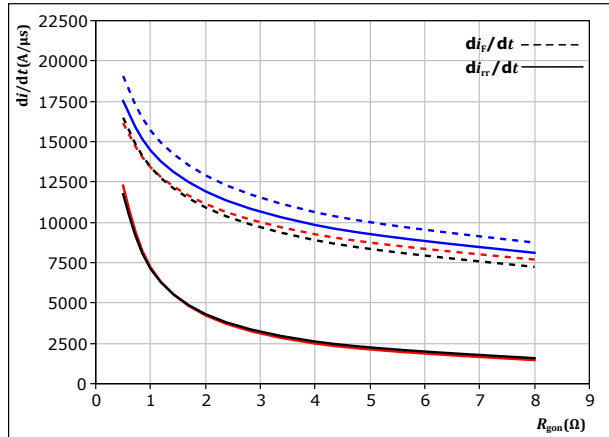

With an inductive load at

$V_{CE} = 350$ V
 $V_{GE} = -5/15$ V
 $I_c = 120$ A

T_j : — 25 °C
 — 125 °C
 — 150 °C

figure 49. IGBT

Reverse bias safe operating area

$I_c = f(V_{CE})$

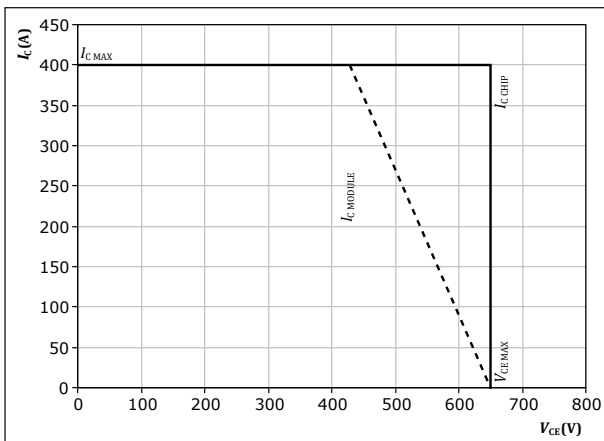

At $T_j = 150$ °C
 $R_{gon} = 2$ Ω
 $R_{goff} = 2$ Ω



Switching Definitions

figure 50. IGBT

Turn-off Switching Waveforms & definition of t_{doff} , t_{Eoff} (t_{Eoff} = integrating time for E_{off})

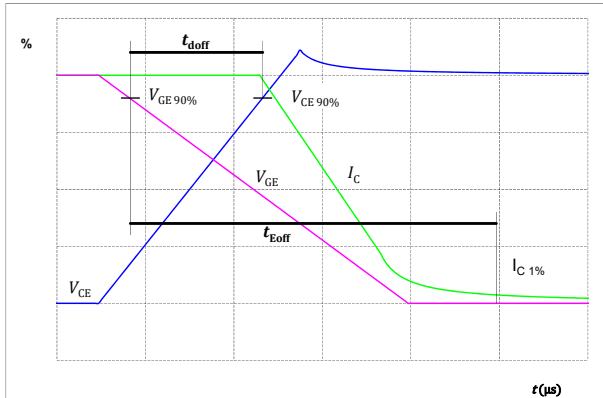

figure 51. IGBT

Turn-on Switching Waveforms & definition of t_{don} , t_{Eon} (t_{Eon} = integrating time for E_{on})

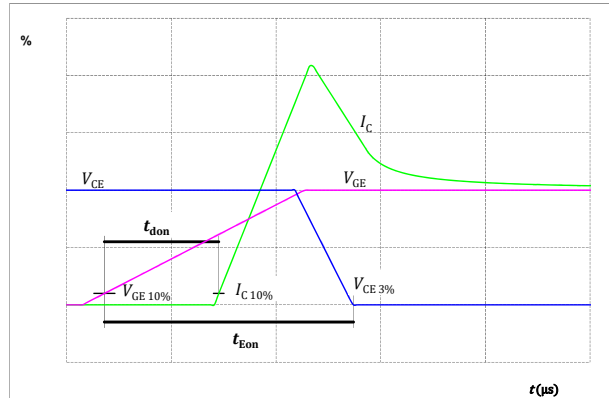

figure 52. IGBT

Turn-off Switching Waveforms & definition of t_f

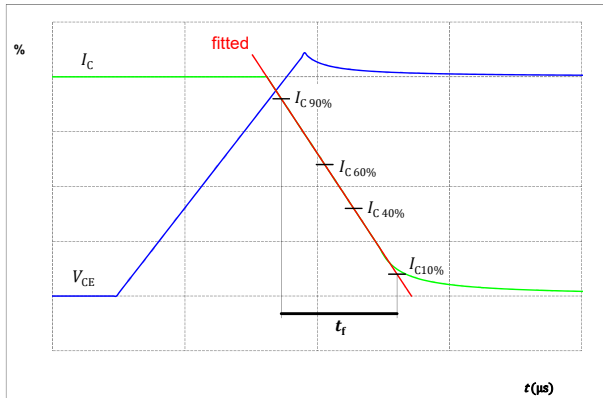
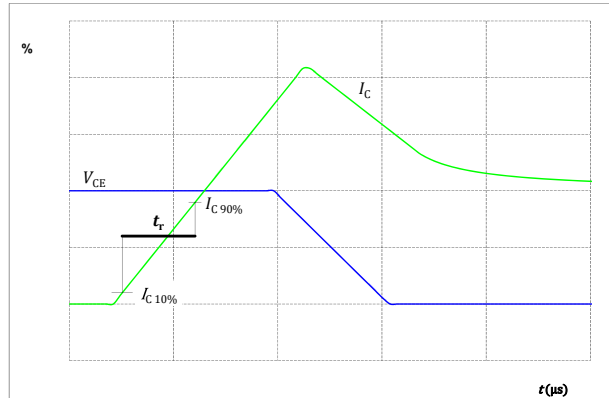

figure 53. IGBT

Turn-on Switching Waveforms & definition of t_r





Switching Definitions

figure 54. FWD

Turn-off Switching Waveforms & definition of t_{rr}

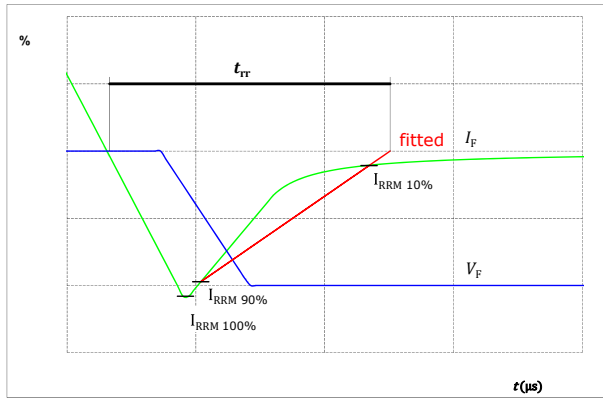
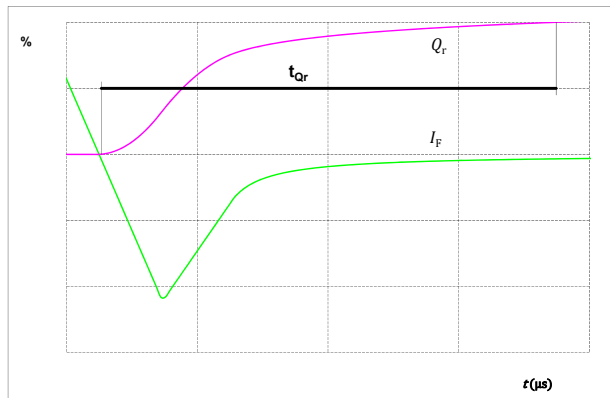

figure 55. FWD

Turn-on Switching Waveforms & definition of t_{Qr} (t_{Qr} = integrating time for Q_r)





Vincotech

30-FT07NIB200S502-LE04F58
datasheet

Ordering Code	
Version	Ordering Code
Without thermal paste	30-FT07NIB200S502-LE04F58
With thermal paste (3,4 W/mK, PSX-P7)	30-FT07NIB200S502-LE04F58-/3/

Marking						
	Text	Name NN-NNNNNNNNNNNNNN- TTTTTVV	Date code WWYY	UL & VIN UL VIN	Lot LLLLL	Serial SSSS
	Datamatrix	Type&Ver TTTTTTVV	Lot number LLLLL	Serial SSSS	Date code WWYY	

Outline							
Pin table [mm]							
Pin	X	Y	Function	28	5	0	DC+1
1	70	6	DC+2	29	2,5	3	DC+1
2	70	3	DC+2	30	2,5	0	DC+1
3	70	0	DC+2	31	0	3	DC+1
4	67,5	3	DC+2	32	0	0	DC+1
5	67,5	0	DC+2	33	32,25	23,55	S12
6	65	0	DC+2	34	29,25	23,55	G12
7	57,75	0	GND2	35	19,95	23,95	S14
8	55,25	0	GND2	36	16,95	25,55	G14
9	52,75	0	GND2	37	2	36	Ph1
10	50,25	0	GND2	38	4,5	36	Ph1
11	43	3	DC-2	39	7	36	Ph1
12	43	0	DC-2	40	9,5	36	Ph1
13	40,5	3	DC-2	41	12	36	Ph1
14	40,5	0	DC-2	42	14,5	36	Ph1
15	38	3	DC-2	43	38	36	Ph2
16	38	0	DC-2	44	40,5	36	Ph2
17	32	3	DC-1	45	43	36	Ph2
18	32	0	DC-1	46	45,5	36	Ph2
19	29,5	3	DC-1	47	48	36	Ph2
20	29,5	0	DC-1	48	50,5	36	Ph2
21	27	3	DC-1	49	64,2	36,6	Therm1
22	27	0	DC-1	50	70,6	36,55	Therm2
23	19,75	0	GND1	51	45,7	24,05	S13
24	17,25	0	GND1	52	48,7	24,05	G13
25	14,75	0	GND1	53	59,2	22	S11
26	12,25	0	GND1	54	62,2	22	G11
27	5	3	DC+1				

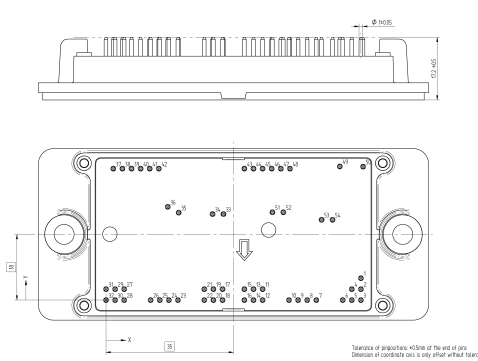

Tolerance of dimensions: $\pm 0,10\text{mm}$ of the end of pins.
Dimension of lead with axis is only shown without tolerance.



Vincotech

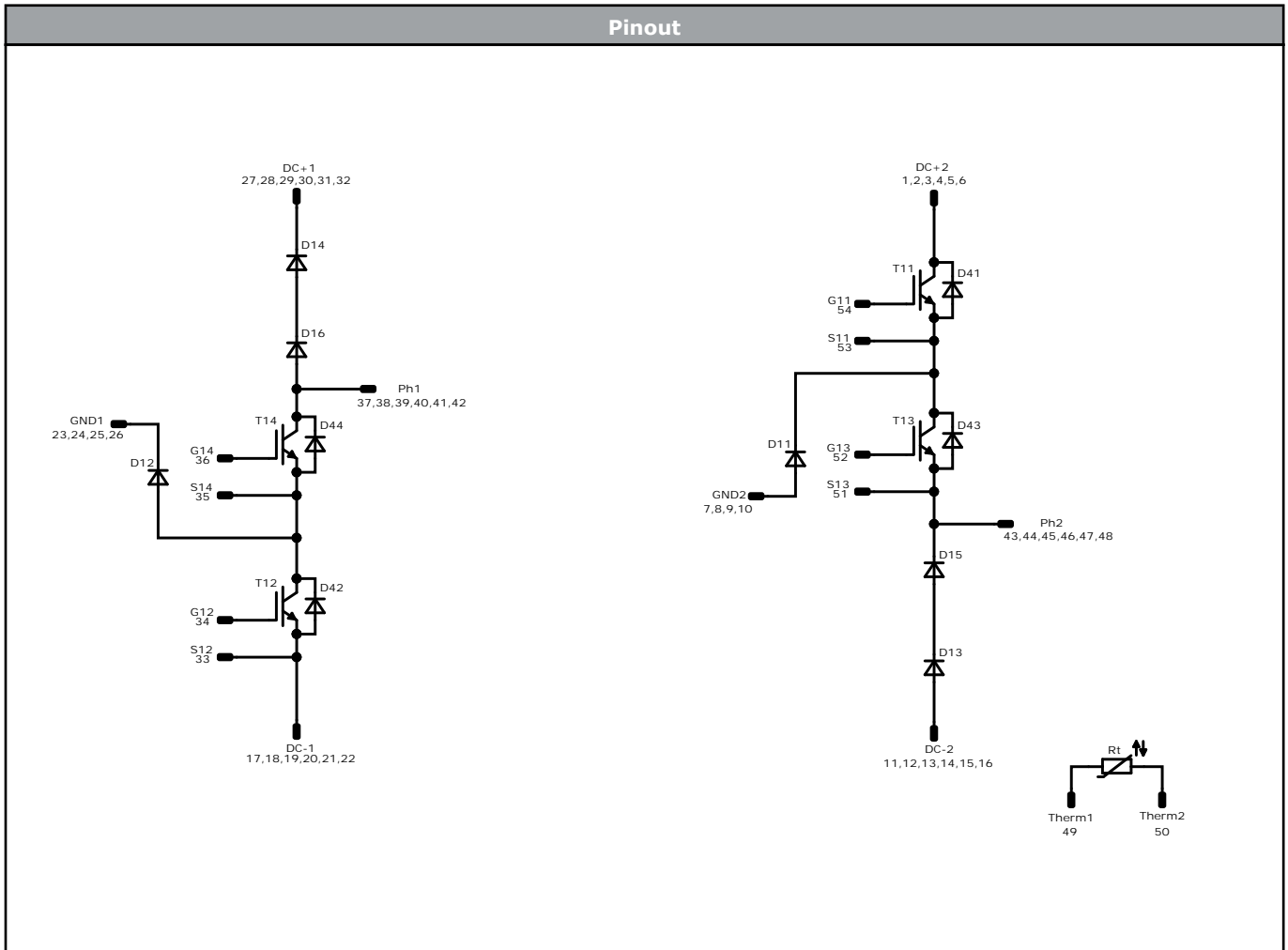

Identification					
ID	Component	Voltage	Current	Function	Comment
T11, T12	IGBT	650 V	200 A	Buck Switch	
D11, D12	FWD	650 V	200 A	Buck Diode	
D41, D42	FWD	650 V	30 A	Buck Sw. Protection Diode	
T13, T14	IGBT	650 V	200 A	Boost Switch	
D13, D15, D14, D16	FWD	1300 V	200 A	Boost Diode	Serial devices. Values apply to complete device.
D43, D44	FWD	650 V	30 A	Boost Sw. Protection Diode	
Rt	Thermistor			Thermistor	



Packaging instruction				
Standard packaging quantity (SPQ) 36	>SPQ	Standard	<SPQ	Sample

Handling instruction
Handling instructions for <i>flow 2</i> packages see vincotech.com website.

Package data
Package data for <i>flow 2</i> packages see vincotech.com website.

Vincotech thermistor reference
See Vincotech thermistor reference table at vincotech.com website.

UL recognition and file number
This device is certified according to UL 1557 standard, UL file number E192116. For more information see vincotech.com website. 

Document No.:	Date:	Modification:	Pages
30-FT07NIB200S502-LE04F58-D2-14	9 Feb. 2023	Buck and Boost Sw. Protection Diode static characteristics are updated DC isolation test voltage is updated Separated datasheet New datasheet format, module is unchanged	

DISCLAIMER

The information, specifications, procedures, methods and recommendations herein (together "information") are presented by Vincotech to reader in good faith, are believed to be accurate and reliable, but may well be incomplete and/or not applicable to all conditions or situations that may exist or occur. Vincotech reserves the right to make any changes without further notice to any products to improve reliability, function or design. No representation, guarantee or warranty is made to reader as to the accuracy, reliability or completeness of said information or that the application or use of any of the same will avoid hazards, accidents, losses, damages or injury of any kind to persons or property or that the same will not infringe third parties rights or give desired results. It is reader's sole responsibility to test and determine the suitability of the information and the product for reader's intended use.

LIFE SUPPORT POLICY

Vincotech products are not authorised for use as critical components in life support devices or systems without the express written approval of Vincotech.

As used herein:

1. Life support devices or systems are devices or systems which, (a) are intended for surgical implant into the body, or (b) support or sustain life, or (c) whose failure to perform when properly used in accordance with instructions for use provided in labelling can be reasonably expected to result in significant injury to the user.
2. A critical component is any component of a life support device or system whose failure to perform can be reasonably expected to cause the failure of the life support device or system, or to affect its safety or effectiveness.