



flowBOOST 0 symmetric

600 V / 30 A

Topology features

- Kelvin Emitter for improved switching performance
- Symmetrical Booster
- Temperature sensor

Component features

- Easy paralleling
- Low turn-off losses
- Low collector emitter saturation voltage
- Positive temperature coefficient
- Short tail current

Housing features

- Base isolation: Al₂O₃
- Clip-in, reliable mechanical connection, qualified for wave soldering
- Convex shaped substrate for superior thermal contact
- Thermo-mechanical push-and-pull force relief
- Solder pin

Target applications

- UPS

Types

- 10-FZ06NBA030SA-P914L33

flow 0 12 mm housing

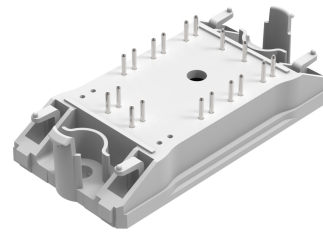

Schematic

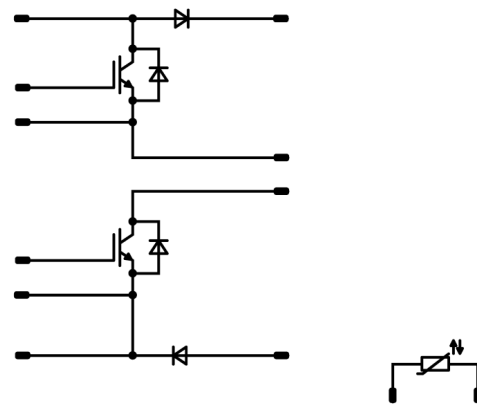



Vincotech

Maximum Ratings

$T_j = 25\text{ °C}$, unless otherwise specified

Parameter	Symbol	Conditions	Value	Unit
Boost Switch				
Collector-emitter voltage	V_{CES}		600	V
Collector current (DC current)	I_C	$T_j = T_{jmax}$ $T_s = 80\text{ °C}$	33	A
Repetitive peak collector current	I_{CRM}	t_p limited by T_{jmax}	90	A
Total power dissipation	P_{tot}	$T_j = T_{jmax}$ $T_s = 80\text{ °C}$	64	W
Gate-emitter voltage	V_{GES}		± 20	V
Short circuit ratings	t_{SC}	$V_{GE} = 15\text{ V}$, $V_{CC} = 360\text{ V}$ $T_j = 150\text{ °C}$	6	μs
Maximum junction temperature	T_{jmax}		175	$^{\circ}\text{C}$

Boost Diode

Peak repetitive reverse voltage	V_{RRM}		600	V
Forward current (DC current)	I_F	$T_j = T_{jmax}$ $T_s = 80\text{ °C}$	32	A
Repetitive peak forward current	I_{FRM}	t_p limited by T_{jmax}	60	A
Total power dissipation	P_{tot}	$T_j = T_{jmax}$ $T_s = 80\text{ °C}$	52	W
Maximum junction temperature	T_{jmax}		175	$^{\circ}\text{C}$

Boost Sw. Protection Diode

Peak repetitive reverse voltage	V_{RRM}		600	V
Forward current (DC current)	I_F	$T_j = T_{jmax}$ $T_s = 80\text{ °C}$	20	A
Repetitive peak forward current	I_{FRM}	t_p limited by T_{jmax}	30	A
Total power dissipation	P_{tot}	$T_j = T_{jmax}$ $T_s = 80\text{ °C}$	38	W
Maximum junction temperature	T_{jmax}		175	$^{\circ}\text{C}$



Maximum Ratings

$T_j = 25\text{ °C}$, unless otherwise specified

Parameter	Symbol	Conditions	Value	Unit
-----------	--------	------------	-------	------

Module Properties

Thermal Properties

Storage temperature	T_{stg}		-40...+125	°C
Operation temperature under switching condition	T_{jop}		-40...+($T_{jmax} - 25$)	°C

Isolation Properties

Isolation voltage	V_{isol}	DC Test Voltage* $t_p = 2\text{ s}$	4000	V
Isolation voltage	V_{isol}	AC Voltage $t_p = 1\text{ min}$	2500	V
Creepage distance			min 12,7	mm
Clearance			min 12,7	mm
Comparative Tracking Index	CTI		≥ 200	

*100 % tested in production



Vincotech

Characteristic Values

Parameter	Symbol	Conditions					Values			Unit
		V_{GS} [V]	V_{GE} [V]	V_{DS} [V]	I_D [A]	T_j [°C]	Min	Typ	Max	

Boost Switch

Static

Gate-emitter threshold voltage	$V_{GE(th)}$	$V_{CE} = V_{GE}$			0,00043	25	5	5,8	6,5	V
Collector-emitter saturation voltage	$V_{CE(sat)}$		15		30	25 150	1,1	1,58 1,81	1,9 ⁽¹⁾	V
Collector-emitter cut-off current	I_{CES}		0	600		25			1,6	μA
Gate-emitter leakage current	I_{GES}		20	0		25			300	nA
Internal gate resistance	r_g							None		Ω
Input capacitance	C_{ies}							1630		pF
Output capacitance	C_{oes}	$f = 1 \text{ Mhz}$	0	25		25		108		pF
Reverse transfer capacitance	C_{res}							50		pF

Thermal

Thermal resistance junction to sink ⁽²⁾	$R_{th(j-s)}$	$\lambda_{paste} = 3,4 \text{ W/mK}$ (PSX)						1,49		K/W
----------------------------------------------------	---------------	-----------------------------------------------	--	--	--	--	--	------	--	-----

Dynamic

Turn-on delay time	$t_{d(on)}$	$R_{gon} = 16 \Omega$ $R_{goff} = 16 \Omega$	±15	300	30	25		102,6		ns
Rise time	t_r					150		103		ns
Turn-off delay time	$t_{d(off)}$					25		152,2		ns
Fall time	t_f					150		172,8		ns
Turn-on energy (per pulse)	E_{on}					25		85,3		mWs
						150		103,23		mWs
Turn-off energy (per pulse)	E_{off}					25		0,402		mWs
		150		0,543		mWs				
		25		0,684		mWs				
		150		0,917		mWs				



Vincotech

10-FZ06NBA030SA-P914L33
datasheet

Characteristic Values

Parameter	Symbol	Conditions					Values			Unit
		V_{GE} [V] V_{GS} [V]	V_{CE} [V] V_{DS} [V] V_F [V]	I_C [A] I_D [A] I_F [A]	T_j [°C]	Min	Typ	Max		

Boost Diode

Static

Forward voltage	V_F				30	25 150	1,25	1,71 1,64	1,95 ⁽¹⁾	V
Reverse leakage current	I_R	$V_r = 600$ V				25			27	μA

Thermal

Thermal resistance junction to sink ⁽²⁾	$R_{th(j-s)}$	$\lambda_{paste} = 3,4$ W/mK (PSX)						1,81		K/W
----------------------------------------------------	---------------	---------------------------------------	--	--	--	--	--	------	--	-----

Dynamic

Peak recovery current	I_{RRM}	$di/dt=2997$ A/μs $di/dt=2520$ A/μs	±15	300	30	25		33,39		A
Reverse recovery time	t_{rr}					150		39,17		
						25		111,1		ns
Recovered charge	Q_r					150		178,03		
						25		1,3		μC
Reverse recovered energy	E_{rec}					150		2,57		
		25		0,27		mWs				
Peak rate of fall of recovery current	$(di_r/dt)_{max}$	150		3664						
		25		1549		A/μs				

Boost Sw. Protection Diode

Static

Forward voltage	V_F				15	25 150	1,25	1,78 1,67	1,95 ⁽¹⁾	V
Reverse leakage current	I_R	$V_r = 600$ V				25			27	μA

Thermal

Thermal resistance junction to sink ⁽²⁾	$R_{th(j-s)}$	$\lambda_{paste} = 3,4$ W/mK (PSX)						2,51		K/W
----------------------------------------------------	---------------	---------------------------------------	--	--	--	--	--	------	--	-----



Vincotech

Characteristic Values

Parameter	Symbol	Conditions					Values			Unit
		V_{GS} [V]	V_{GE} [V]	V_{DS} [V]	V_{CE} [V]	T_j [°C]	Min	Typ	Max	

Thermistor

Static

Rated resistance	R					25		22		kΩ
Deviation of R_{100}	$A_{R/R}$	$R_{100} = 1484 \Omega$				100	-5		5	%
Power dissipation	P					25		130		mW
Power dissipation constant	d					25		1,5		mW/K
B-value	$B_{(25/50)}$	Tol. $\pm 1 \%$						3962		K
B-value	$B_{(25/100)}$	Tol. $\pm 1 \%$						4000		K
Vincotech Thermistor Reference									I	

⁽¹⁾ Value at chip level

⁽²⁾ Only valid with pre-applied Vincotech thermal interface material.



Boost Switch Characteristics

figure 1. IGBT

Typical output characteristics

$$I_C = f(V_{CE})$$

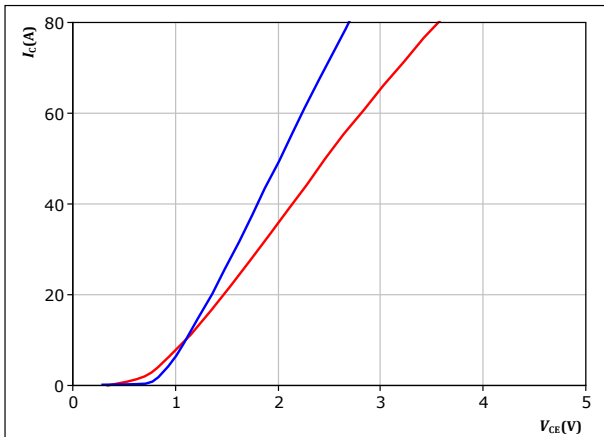

$t_p = 250 \mu s$
 $V_{GE} = 15 V$
 $T_j: 25^\circ C$ (blue line), $150^\circ C$ (red line)

figure 2. IGBT

Typical output characteristics

$$I_C = f(V_{CE})$$

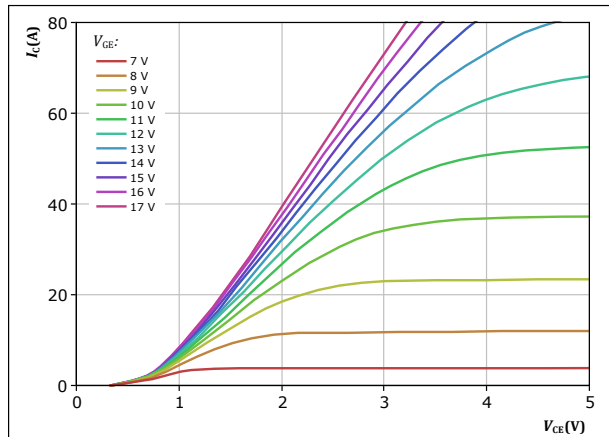

$t_p = 250 \mu s$
 $T_j = 150^\circ C$
 V_{GE} from 7 V to 17 V in steps of 1 V

figure 3. IGBT

Typical transfer characteristics

$$I_C = f(V_{GE})$$

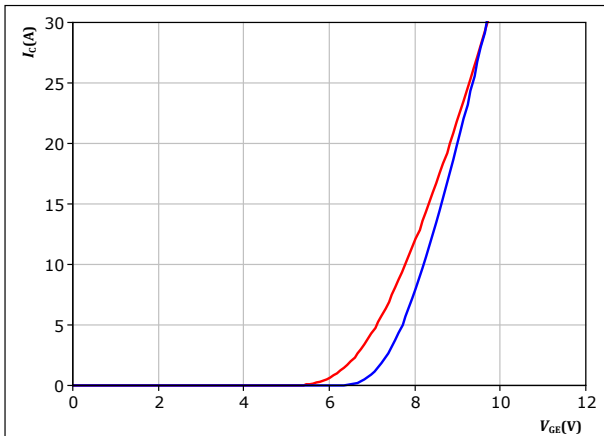

$t_p = 250 \mu s$
 $V_{CE} = 10 V$
 $T_j: 25^\circ C$ (blue line), $150^\circ C$ (red line)

figure 4. IGBT

Transient thermal impedance as a function of pulse width

$$Z_{th(j-s)} = f(t_p)$$

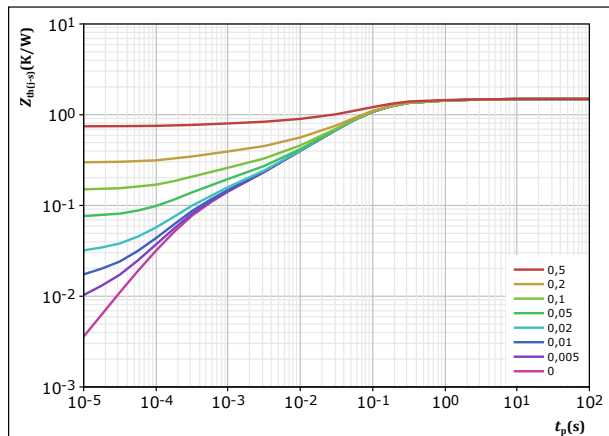

$D = t_p / T$
 $R_{th(j-s)} = 1,49 K/W$
IGBT thermal model values

R (K/W)	τ (s)
7,25E-02	2,15E+00
1,02E-01	4,82E-01
6,96E-01	9,49E-02
3,56E-01	3,40E-02
1,42E-01	5,95E-03
4,77E-02	1,04E-03
7,51E-02	2,72E-04



Vincotech

Boost Switch Characteristics

figure 5. IGBT

Safe operating area

$$I_C = f(V_{CE})$$

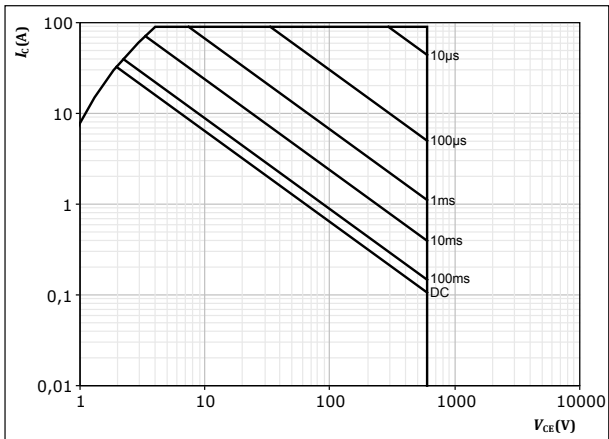

$D =$ single pulse
 $T_s = 80 \text{ } ^\circ\text{C}$
 $V_{CE} = 15 \text{ V}$
 $T_j = T_{jmax}$



Boost Diode Characteristics

figure 6. FWD

Typical forward characteristics

$$I_F = f(V_F)$$

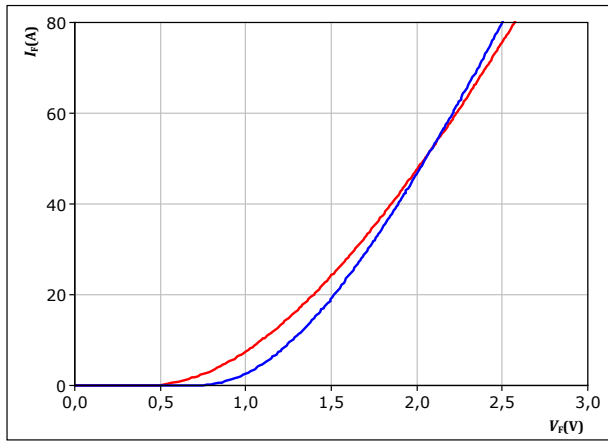

$t_p = 250 \mu s$
 $T_j: 25 \text{ }^\circ\text{C}$ (blue line)
 $150 \text{ }^\circ\text{C}$ (red line)

figure 7. FWD

Transient thermal impedance as a function of pulse width

$$Z_{th(j-s)} = f(t_p)$$

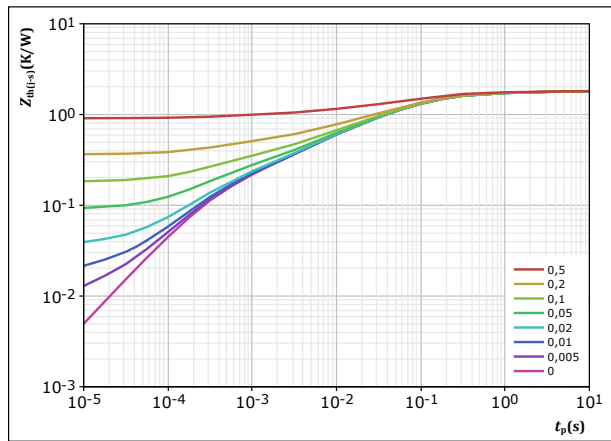

$D = t_p / T$
 $R_{th(j-s)} = 1,811 \text{ K/W}$
 FWD thermal model values

R (K/W)	τ (s)
8,35E-02	4,59E+00
2,01E-01	4,81E-01
7,60E-01	9,25E-02
4,22E-01	1,80E-02
2,13E-01	3,31E-03
1,40E-01	3,46E-04



Boost Sw. Protection Diode Characteristics

figure 8. FWD

Typical forward characteristics

$$I_F = f(V_F)$$

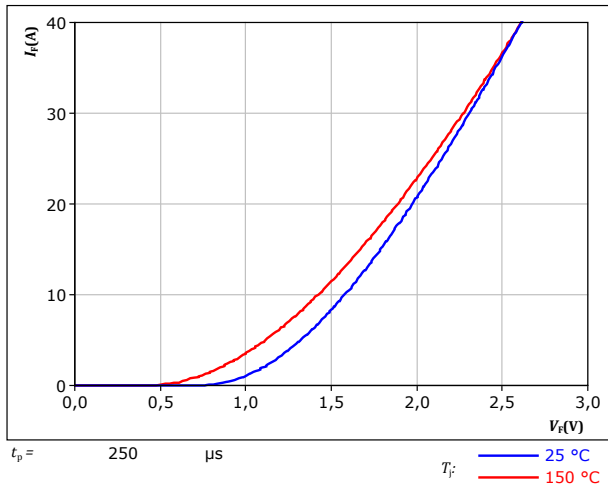
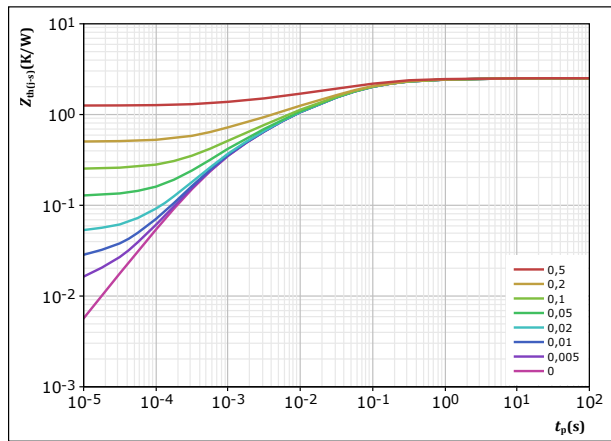

figure 9. FWD

Transient thermal impedance as a function of pulse width

$$Z_{th(j-s)} = f(t_p)$$



$D = t_p / T$
 $R_{th(j-s)} = 2,513\text{ K/W}$
 FWD thermal model values

R (K/W)	τ (s)
9,70E-02	3,90E+00
2,83E-01	3,08E-01
8,79E-01	6,57E-02
5,75E-01	1,54E-02
4,51E-01	3,41E-03
2,27E-01	5,87E-04



Thermistor Characteristics

figure 10. Thermistor

Typical NTC characteristic as function of temperature

$$R_T = f(T)$$

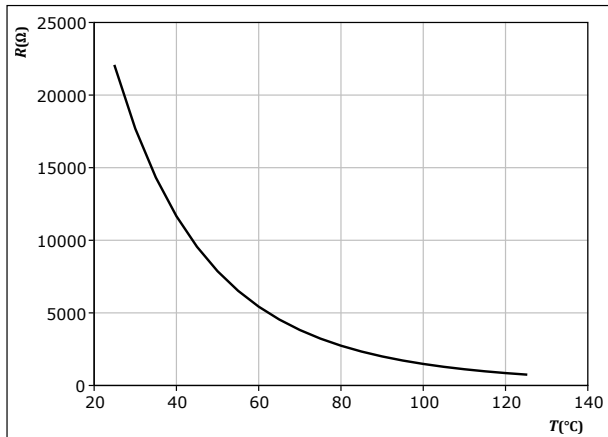



Boost Switching Characteristics

figure 11. IGBT

Typical switching energy losses as a function of collector current
 $E = f(I_c)$

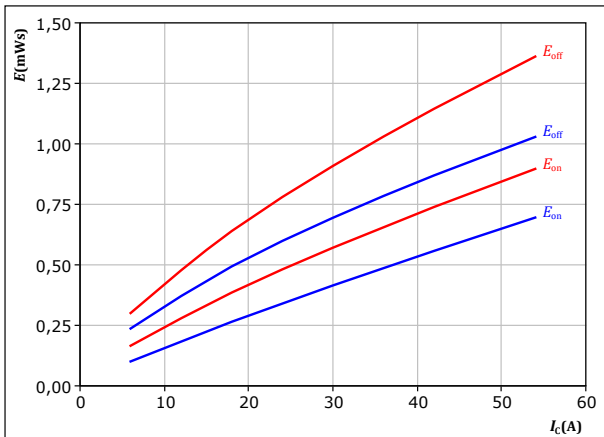

With an inductive load at
 $V_{CE} = 300$ V
 $V_{GE} = \pm 15$ V
 $R_{gon} = 16$ Ω
 $R_{goff} = 16$ Ω
 T_j : — 25 °C
— 150 °C

figure 12. IGBT

Typical switching energy losses as a function of IGBT turn on gate resistor
 $E = f(R_g)$

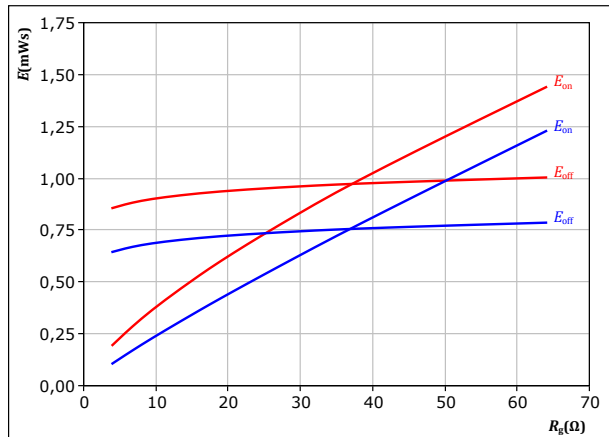

With an inductive load at
 $V_{CE} = 300$ V
 $V_{GE} = \pm 15$ V
 $I_c = 30$ A
 T_j : — 25 °C
— 150 °C

figure 13. FWD

Typical reverse recovered energy loss as a function of collector current
 $E_{rec} = f(I_c)$

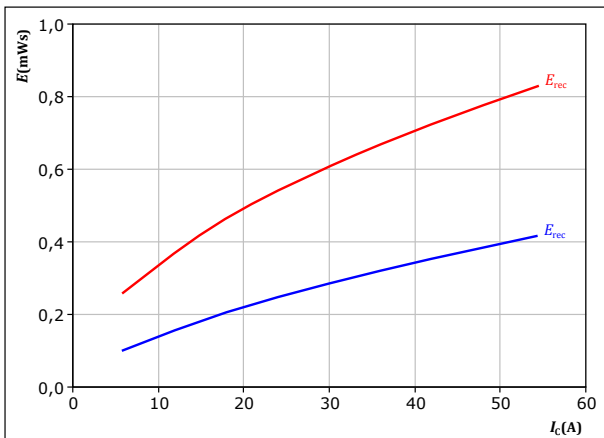

With an inductive load at
 $V_{CE} = 300$ V
 $V_{GE} = \pm 15$ V
 $R_{gon} = 16$ Ω
 T_j : — 25 °C
— 150 °C

figure 14. FWD

Typical reverse recovered energy loss as a function of IGBT turn on gate resistor
 $E_{rec} = f(R_g)$

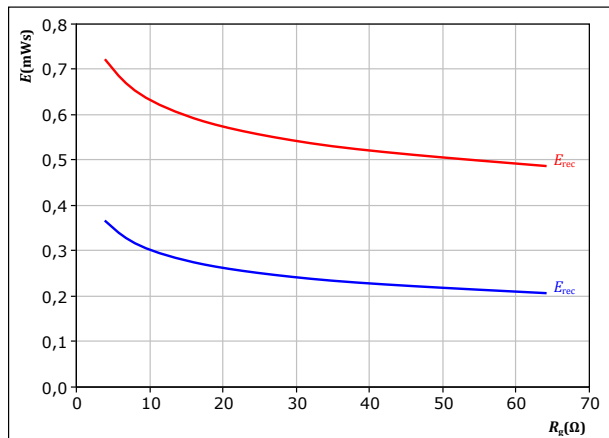

With an inductive load at
 $V_{CE} = 300$ V
 $V_{GE} = \pm 15$ V
 $I_c = 30$ A
 T_j : — 25 °C
— 150 °C



Boost Switching Characteristics

figure 15. IGBT

Typical switching times as a function of collector current
 $t = f(I_c)$

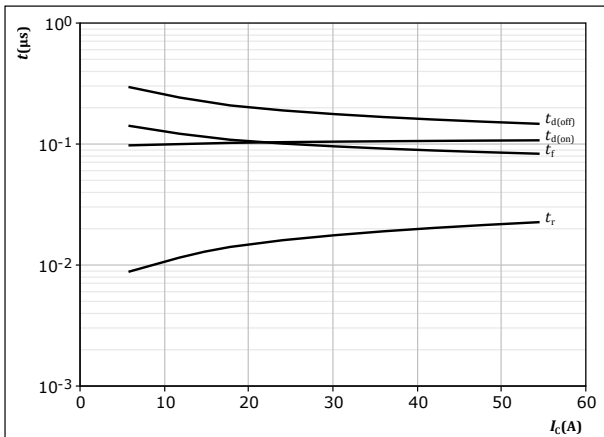

With an inductive load at
 $T_j = 150 \text{ }^\circ\text{C}$
 $V_{CE} = 300 \text{ V}$
 $V_{GE} = \pm 15 \text{ V}$
 $R_{gon} = 16 \text{ } \Omega$
 $R_{goff} = 16 \text{ } \Omega$

figure 16. IGBT

Typical switching times as a function of IGBT turn on gate resistor
 $t = f(R_g)$

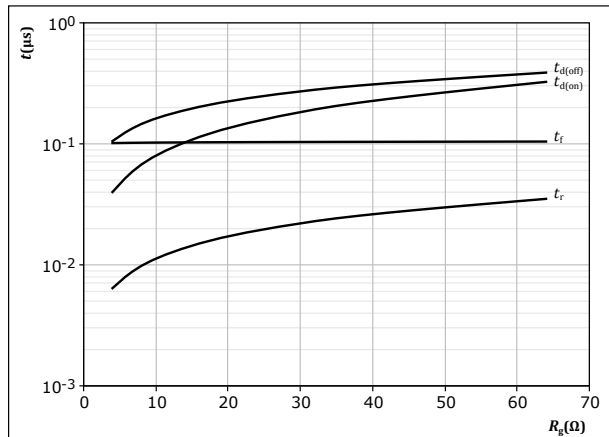

With an inductive load at
 $T_j = 150 \text{ }^\circ\text{C}$
 $V_{CE} = 300 \text{ V}$
 $V_{GE} = \pm 15 \text{ V}$
 $I_c = 30 \text{ A}$

figure 17. FWD

Typical reverse recovery time as a function of collector current
 $t_{rr} = f(I_c)$

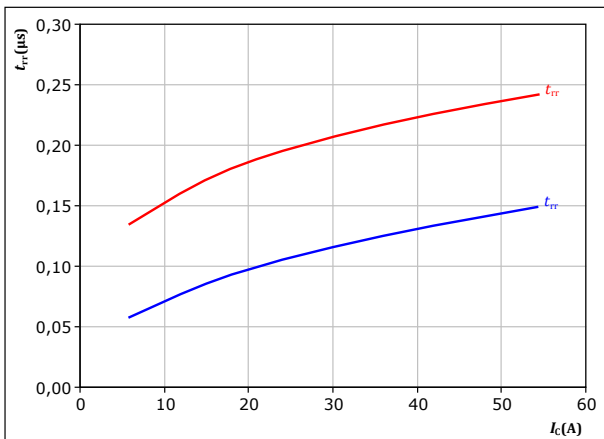

With an inductive load at
 $V_{CE} = 300 \text{ V}$
 $V_{GE} = \pm 15 \text{ V}$
 $R_{gon} = 16 \text{ } \Omega$
 $T_j: \text{ — } 25 \text{ }^\circ\text{C}$
 $\text{ — } 150 \text{ }^\circ\text{C}$

figure 18. FWD

Typical reverse recovery time as a function of IGBT turn on gate resistor
 $t_{rr} = f(R_{gon})$

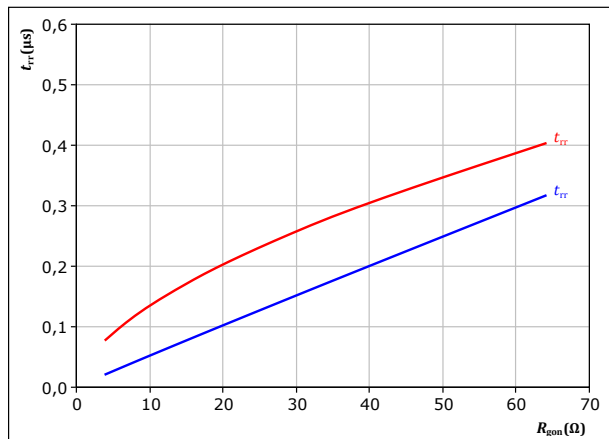

With an inductive load at
 $V_{CE} = 300 \text{ V}$
 $V_{GE} = \pm 15 \text{ V}$
 $I_c = 30 \text{ A}$
 $T_j: \text{ — } 25 \text{ }^\circ\text{C}$
 $\text{ — } 150 \text{ }^\circ\text{C}$



Boost Switching Characteristics

figure 19. FWD

Typical recovered charge as a function of collector current

$$Q_r = f(I_c)$$

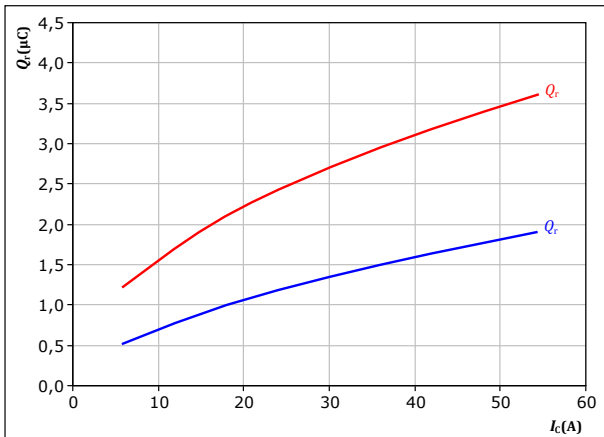

With an inductive load at

$V_{CE} = 300$ V
 $V_{GE} = \pm 15$ V
 $R_{gon} = 16$ Ω

T_j : — 25 °C
— 150 °C

figure 20. FWD

Typical recovered charge as a function of IGBT turn on gate resistor

$$Q_r = f(R_{gon})$$

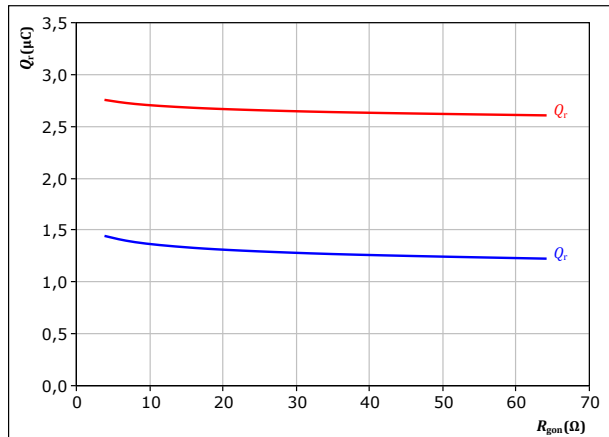

With an inductive load at

$V_{CE} = 300$ V
 $V_{GE} = \pm 15$ V
 $I_c = 30$ A

T_j : — 25 °C
— 150 °C

figure 21. FWD

Typical peak reverse recovery current as a function of collector current

$$I_{RM} = f(I_c)$$

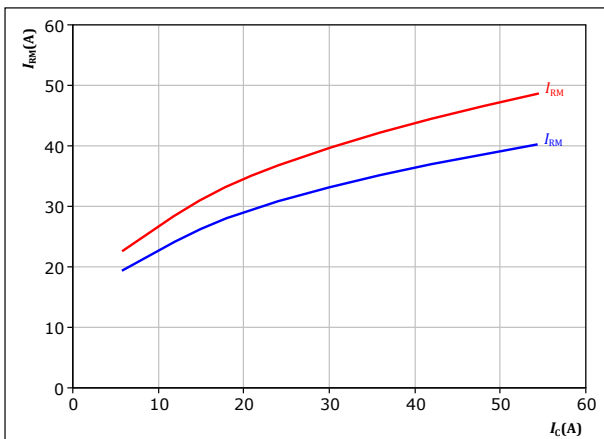

With an inductive load at

$V_{CE} = 300$ V
 $V_{GE} = \pm 15$ V
 $R_{gon} = 16$ Ω

T_j : — 25 °C
— 150 °C

figure 22. FWD

Typical peak reverse recovery current as a function of IGBT turn on gate resistor

$$I_{RM} = f(R_{gon})$$

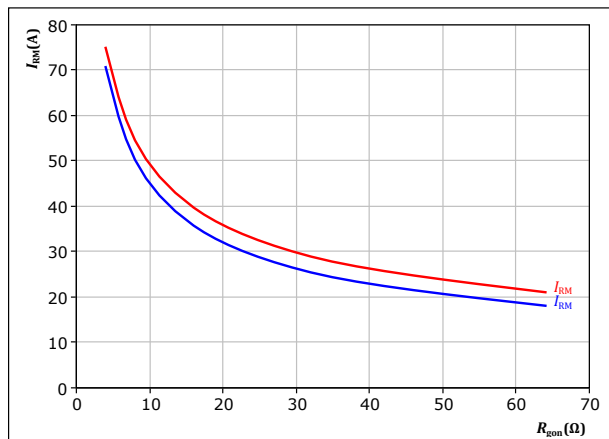

With an inductive load at

$V_{CE} = 300$ V
 $V_{GE} = \pm 15$ V
 $I_c = 30$ A

T_j : — 25 °C
— 150 °C



Boost Switching Characteristics

figure 23. FWD

Typical rate of fall of forward and reverse recovery current as a function of collector current
 $di_f/dt, di_r/dt = f(I_c)$

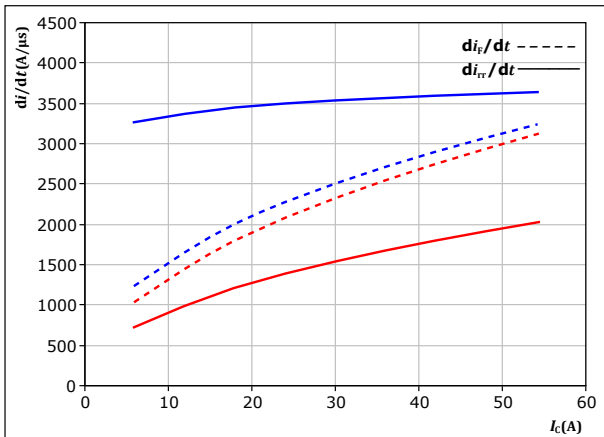

With an inductive load at

$V_{CE} = 300$ V
 $V_{GE} = \pm 15$ V
 $R_{gon} = 16$ Ω

T_j : — 25 °C
 — 150 °C

figure 24. FWD

Typical rate of fall of forward and reverse recovery current as a function of turn on gate resistor
 $di_f/dt, di_r/dt = f(R_{gon})$

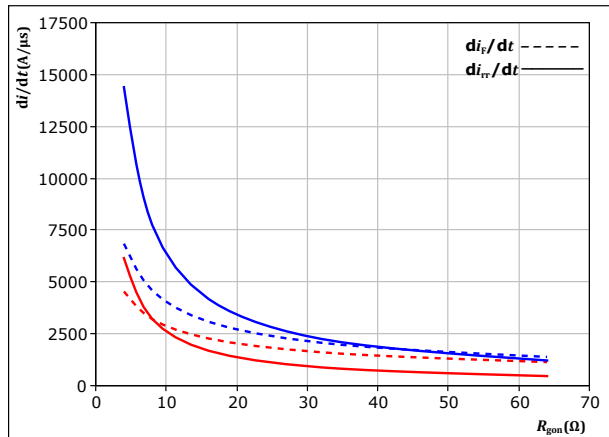

With an inductive load at

$V_{CE} = 300$ V
 $V_{GE} = \pm 15$ V
 $I_c = 30$ A

T_j : — 25 °C
 — 150 °C

figure 25. IGBT

Reverse bias safe operating area

$I_c = f(V_{CE})$

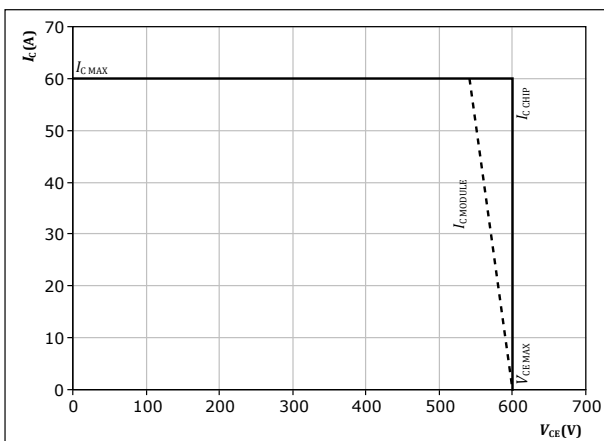

At $T_j = 150$ °C
 $R_{gon} = 16$ Ω
 $R_{goff} = 16$ Ω



Boost Switching Definitions

figure 26. IGBT

Turn-off Switching Waveforms & definition of t_{doff} , t_{Eoff} (t_{Eoff} = integrating time for E_{off})

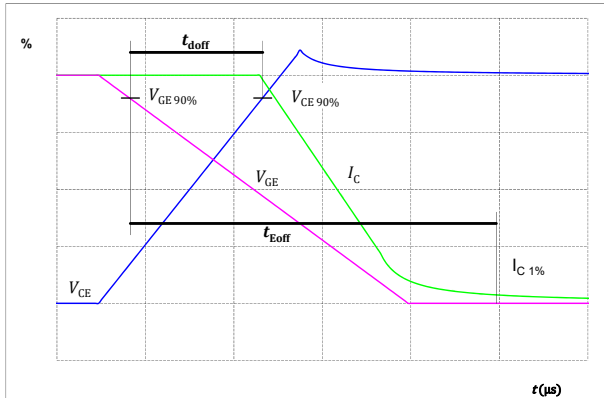

figure 27. IGBT

Turn-on Switching Waveforms & definition of t_{don} , t_{Eon} (t_{Eon} = integrating time for E_{on})

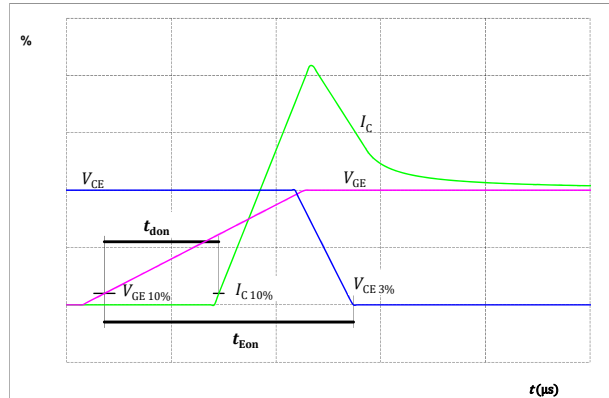

figure 28. IGBT

Turn-off Switching Waveforms & definition of t_f

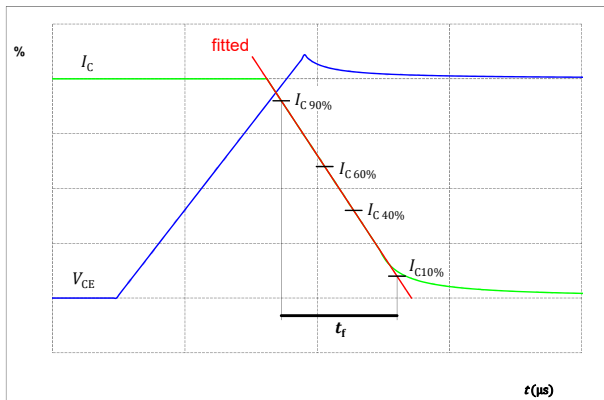
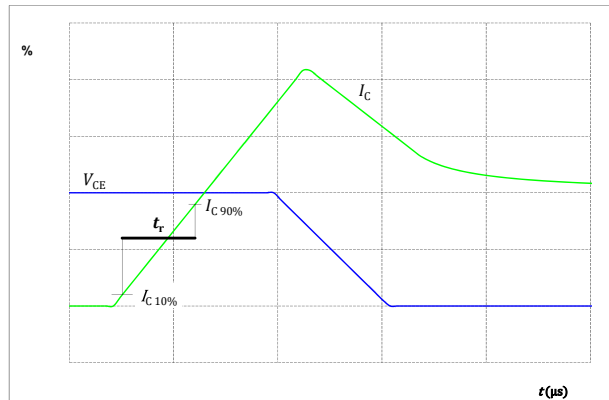

figure 29. IGBT

Turn-on Switching Waveforms & definition of t_r





Boost Switching Definitions

figure 30. FWD

Turn-off Switching Waveforms & definition of t_{rr}

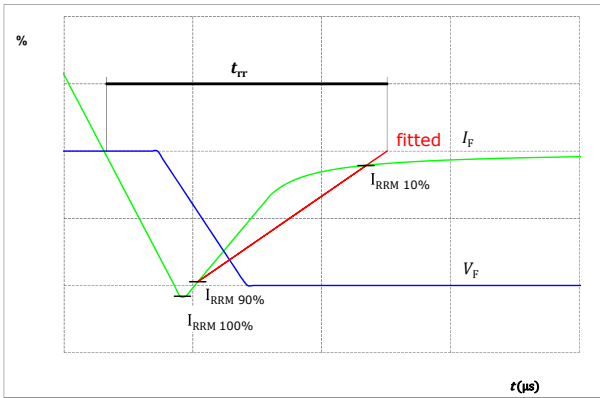
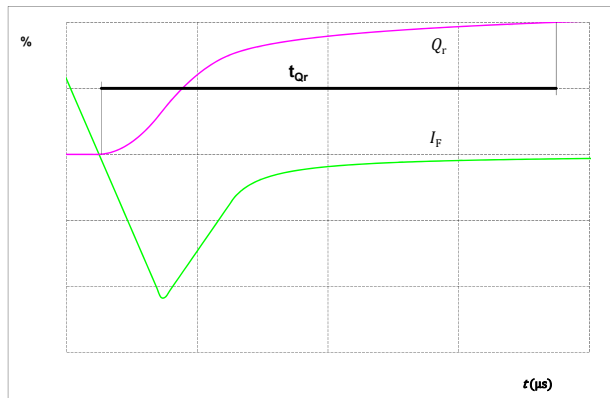

figure 31. FWD

Turn-on Switching Waveforms & definition of t_{Qr} (t_{Qr} = integrating time for Q_r)





Ordering Code	
Version	Ordering Code
Without thermal paste	10-FZ06NBA030SA-P914L33
With thermal paste (5,2 W/mK, PTM6000HV)	10-FZ06NBA030SA-P914L33-/7/
With thermal paste (3,4 W/mK, PSX-P7)	10-FZ06NBA030SA-P914L33-/3/

Marking						
Text	Name		Date code	UL & VIN	Lot	Serial
	NN-NNNNNNNNNNNNNN- TTTTTIVV		WWYY	UL VIN	LLLLL	SSSS
	Datamatrix	Type&Ver	Lot number	Serial	Date code	
	TTTTTIVV	LLLLL	SSSS	WWYY		

Outline			
Pin table [mm]			
Pin	X	Y	Function
1	33,6	0	G1
2	30,6	0	S1
3	23,65	0	+GND
4	20,65	0	+GND
5	14,9	0	+DC
6	11,9	0	+DC
7	not assembled		
8	not assembled		
9	0	7,8	+Boost
10	3	7,8	+Boost
11	0	14,8	-Boost
12	3	14,8	-Boost
13	not assembled		
14	not assembled		
15	11,9	22,6	-DC
16	14,9	22,6	-DC
17	20,65	22,6	-GND
18	23,65	22,6	-GND
19	30,6	22,6	S2
20	33,6	22,6	G2
21	33,6	14,55	NTC1
22	33,6	8,05	NTC2

Tolerance of pinpositions: ±0.05mm at the end of pins
Dimension of coordinate axis is only offset without tolerance

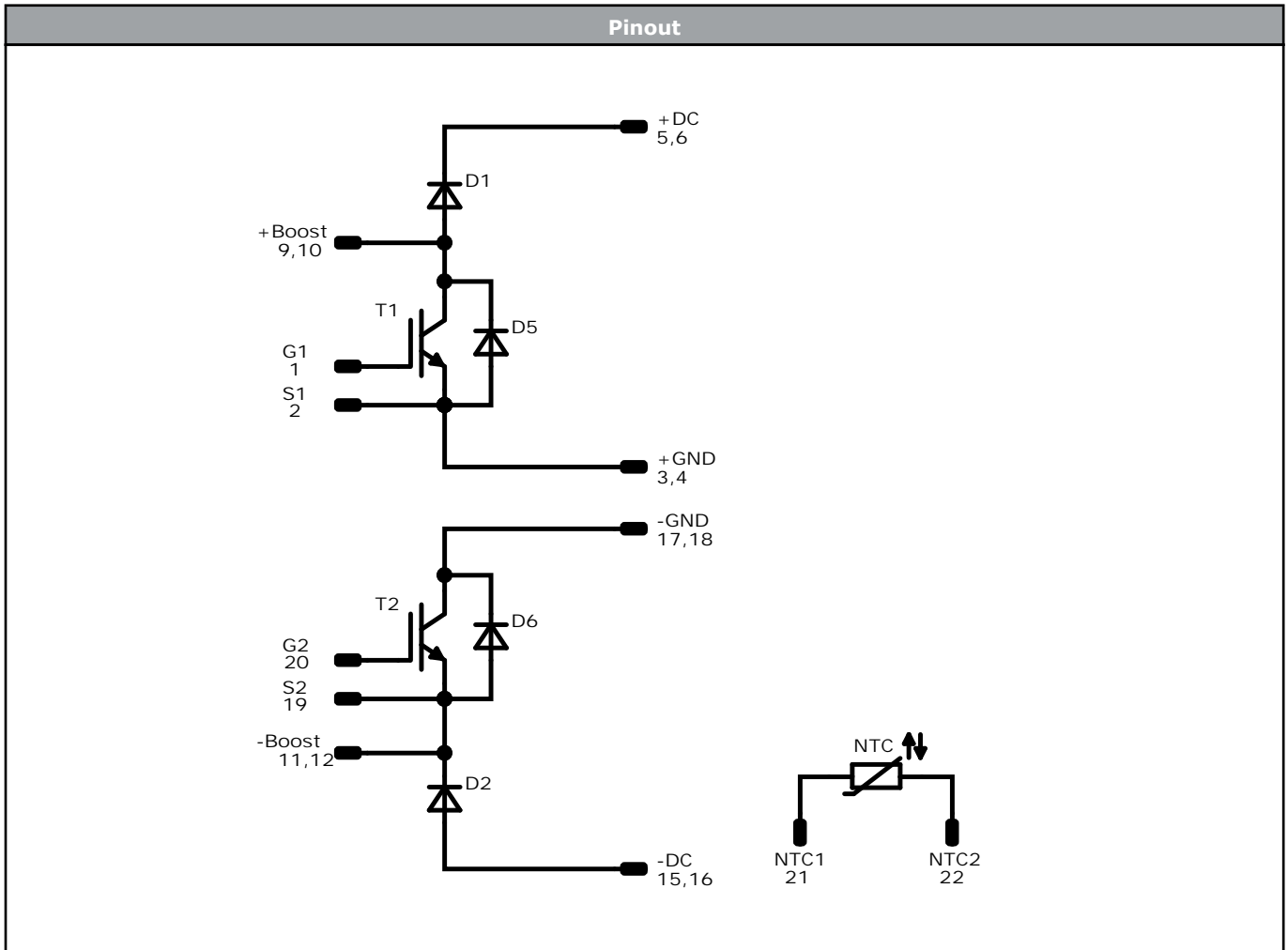

Identification					
ID	Component	Voltage	Current	Function	Comment
T2, T1	IGBT	600 V	30 A	Boost Switch	
D2, D1	FWD	600 V	30 A	Boost Diode	
D6, D5	FWD	600 V	15 A	Boost Sw. Protection Diode	
NTC	Thermistor			Thermistor	



Packaging instruction				
Standard packaging quantity (SPQ) 135	>SPQ	Standard	<SPQ	Sample

Handling instruction
Handling instructions for <i>flow 0</i> packages see vincotech.com website.

Package data
Package data for <i>flow 0</i> packages see vincotech.com website.

Vincotech thermistor reference
See Vincotech thermistor reference table at vincotech.com website.

UL recognition and file number
This device is certified according to UL 1557 standard, UL file number E192116. For more information see vincotech.com website. 

Document No.:	Date:	Modification:	Pages
10-FZ06NBA030SA-P914L33-D3-14	5 May. 2022	New Datasheet format, module is unchanged Introduce Rth values with PSX-P7 TIM	

DISCLAIMER

The information, specifications, procedures, methods and recommendations herein (together "information") are presented by Vincotech to reader in good faith, are believed to be accurate and reliable, but may well be incomplete and/or not applicable to all conditions or situations that may exist or occur. Vincotech reserves the right to make any changes without further notice to any products to improve reliability, function or design. No representation, guarantee or warranty is made to reader as to the accuracy, reliability or completeness of said information or that the application or use of any of the same will avoid hazards, accidents, losses, damages or injury of any kind to persons or property or that the same will not infringe third parties rights or give desired results. It is reader's sole responsibility to test and determine the suitability of the information and the product for reader's intended use.

LIFE SUPPORT POLICY

Vincotech products are not authorised for use as critical components in life support devices or systems without the express written approval of Vincotech.

As used herein:

1. Life support devices or systems are devices or systems which, (a) are intended for surgical implant into the body, or (b) support or sustain life, or (c) whose failure to perform when properly used in accordance with instructions for use provided in labelling can be reasonably expected to result in significant injury to the user.
2. A critical component is any component of a life support device or system whose failure to perform can be reasonably expected to cause the failure of the life support device or system, or to affect its safety or effectiveness.