

CHT-LDOS Datasheet

Version: 2.7
19-Sep-22
(Last Modification Date)

High-Temperature, 1A Low-Dropout Voltage Regulator for symmetrical voltage applications. 3.3V; 5V; 12V or 15V (2.5V; 5.25V; 5.5V; 9V; 10V; 13V)

General Description

The CHT-LDOS is a 1A, low-dropout linear voltage regulator compatible with high-temperature environments. Typical operation temperature range extends from -55°C to 225°C.

The circuit is stable throughout the whole temperature range and under a large choice of capacitive loads.

The minimum dropout voltage ($V_{in}-V_{out}$) is 2V with a 1A load current at 225°C and 1V for load currents lower than 400mA. The dropout voltage can span from 1 Volts to 20 Volts⁽¹⁾.

CHT-LDOS is available in TO-254 package, TO-3 package and in bare die.

Related documents:

- **AN-06016:** "Selecting correct CISSOID regulator depending on your application"
- **AN-06002:** "Voltage regulator short-circuit protection and associated potential startup problem".
- **AN-090477:** "Power Dissipation Considerations During Short Circuit Conditions"

Applications

Power supplies for high-temperature electronic systems used in Automotive, Aeronautics, Aerospace or Oil&Gas applications

Features

- 1V to 20V dropout Voltage @400mA⁽¹⁾
- 2V to 20V dropout Voltage @1A⁽¹⁾
- Max 1A output current @ 225°C
- 60dB input ripple rejection (0-100Hz)
- C_{load} from 100nF to 1000µF, large ESR range
- Output voltage programmable by bonding option (bare die version)
- Available in TO-254 and TO-3 package and bare die form (contact CISSOID)
- The start-up is operative over the whole temperature range
- Latch-up free
- Validated at 225°C for 43800 hours

Standard voltages

- CHT-LDOS-033: 3.3V
- CHT-LDOS-050: 5.0V
- CHT-LDOS-120: 12.0V
- CHT-LDOS-150: 15.0V

Special voltages¹

- CHT-LDOS-025: 2.5V
- CHT-LDOS-0525: 5.25V
- CHT-LDOS-055: 5.5V
- CHT-LDOS-090: 9.0V
- CHT-LDOS-100: 10.0V
- CHT-LDOS-130: 13.0V

Typical application

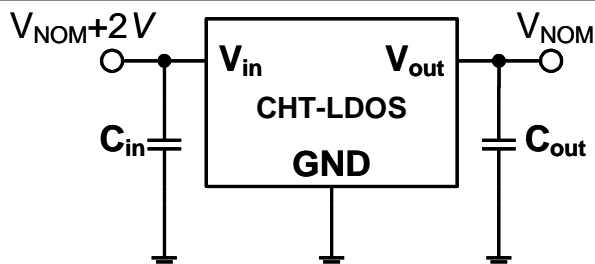

¹ Different lead times or MOQ may apply

Absolute Maximum Ratings

Supply Voltage V_{in}	-0.3V...40V
Junction Temperature ⁽²⁾ (T_j)	315°C
Power dissipation ⁽³⁾	

Operating Conditions

Supply Voltage V_{in} to GND	$V_{out}+(1V \text{ to } 20V)^{(1)}$
Junction temperature	-55°C to +225°C
Power dissipation ⁽³⁾	

ESD Rating (expected)

Human Body Model	<1kV
------------------	------

CAUTION: Stresses above those listed in "Absolute Maximum Ratings" may cause permanent damage to the device. This is a stress only rating and operation of the device at these or any other conditions above those indicated in the operational sections of this specification is not implied. Frequent or extended exposure to absolute maximum rating conditions or above may affect device reliability.

Electrical Characteristics

Unless otherwise stated, the following table is relative to the 5V mode (CHT-LDOS-050) with $V_{in}=7V$ ($V_{out}+2V$). For other nominal voltages, see notes under this table.

Parameter	Condition	Min	Typ	Max	Units	Note
Output voltage accuracy	$I_L=10mA$ -55°C < T_j < 225°C	-2	0	2	%	
Output voltage Temperature drift	$I_L=10mA$ 25°C < T_j < 225°C	0	40	80	ppm	(4)
Output voltage line regulation	dropout=2V to 15V $I_L=60mA$, -55°C < T_j < 225°C	-1		1	mV/V	(5)
Output voltage load regulation (i.e. R_{out})	$I_L=10mA$ to 1A @ 2V dropout -55°C < T_j < 225°C		0.04	0.1	V/A	(6)
(Vin-Vout) (dropout)	$I_L \leq 400mA$, -55°C < T_j < 225°C	1			V	
	$I_L=1A$, -55°C < T_j < 225°C	2			V	
Quiescent Ground Pin current	$0 < I_L < 1A$ -55°C 225°C		3.2 2.9		mA	(7)
Power supply rejection ratio	$f=0Hz \dots 100Hz$ $I_{load}=100mA$		60		dB	
Foldback current			2.5		A	
Short-circuit current	20°C < T_j < 225°C		300		mA	
Output noise	10Hz-10kHz $I_L=100mA$, -30°C < T_j < 225°C		tbd		μV_{RMS}	

Notes:

- (1) $V_{in} \text{ max}=30V$
- (2) Above 225°C (T_j), a minimum load current of few mA could be required.
- (3) Max Power dissipation depends on packaging. CHT-LDOS in TO-3 or TO-254 packages presents a "junction-to-case" thermal resistance of maximum 5°C/W (R_{th}).
- (4) ppm are defined as $[d(V_{out})/d(T)]/V_{out}$. For 5V mode, 40ppm corresponds to 200 $\mu V/^\circ C$.
- (5) Defining "x" as the nominal voltage, the line regulation is better than x/5 mV/V.
- (6) This includes the packaging parasitic resistor.
- (7) Defining "x" as the nominal voltage, the typical quiescent current at 2V dropout can be approximated as 2.8+x/13 mA @ -30°C and 2.5+x/13 mA at 225°C.

Output Load (recommended specifications)

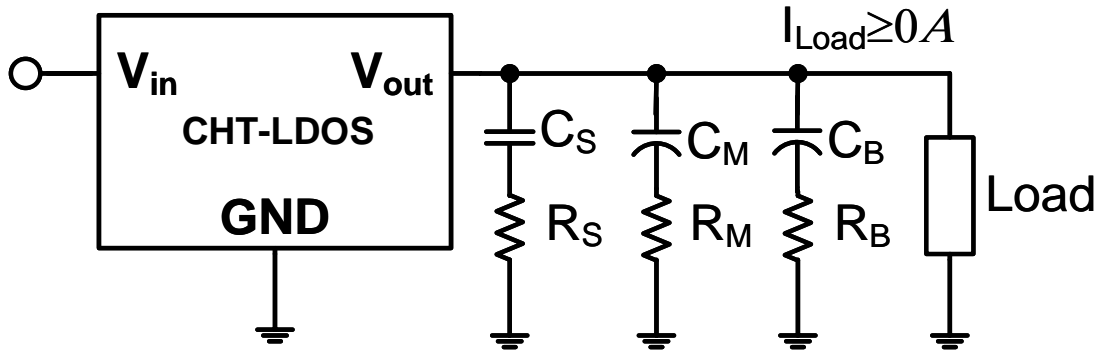

Resistances in series with capacitors represent the internal ESR of these capacitors.

For large capacitors:

$C_B = 0$ to $1000\mu F$
 $R_B = 0.2$ to $\infty \Omega$

For medium capacitors:

$C_M = 0$ to $6\mu F$
 $R_M = 0.1$ to 1Ω

For small Capacitors:

$C_S = 100n$ to $220nF$
 $R_S = 10m$ to $50m \Omega$

Operating Conditions

Start-up conditions

The start-up is operative over the whole temperature range as long as the current flowing from a positive voltage and the negative voltage is below 500mA.

Please refer to our application notes for more details:

- **AN-06016:** "Selecting correct CISSOID regulator depending on your application"
- **AN-06002:** "Voltage regulator short-circuit protection and associated potential startup problem".

Power dissipation considerations

When determining the maximum power dissipated by the regulator, not only the dissipation during normal operation must be considered, but also the power dissipated during any eventual short circuit or overload.

During short circuit or overload, worst case conditions are normally found for maximum V_{in} and a shorting resistance in the order of few Ohms.

Entering into short-circuit or overload conditions with high input voltages V_{in} may lead to extreme overheating, placing the

part above Absolute Maximum Rating conditions.

Please refer to our application note for more detail:

- **AN-090477:** "Power Dissipation Considerations During Short Circuit Conditions"

Shorting the regulator input

If the input terminal is shorted to ground once the output capacitance has been charged, a large current corresponding to the discharge of the output capacitor will flow from the output to the input through the drain-body diode of the internal pass transistor. This large current may cause the permanent damage of the part.

Sinking current or raising the output voltage above the input voltage can cause permanent damage to the part.

Regulator floating ground

When the ground becomes disconnected, the output voltage gets unregulated, causing possible damage to other circuits connected to V_{out} . If the ground terminal is reconnected while V_{in} is applied, permanent damage may also occur to the regulator. If a regulator needs to be reconnected with the power supply on, then connect the ground terminal first.

Typical Performance Characteristics (CHT-LDOS-150)

Note: Temperatures hereafter are ambient temperatures, not junction temperatures.

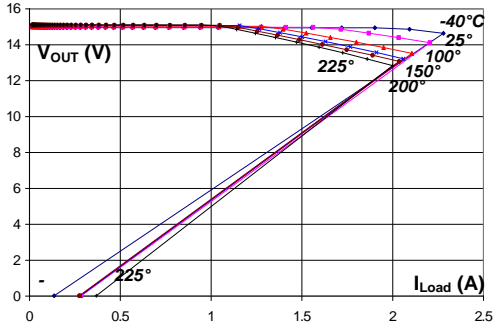

Figure 1: V_{out} vs. I_{Load} @ 2V dropout

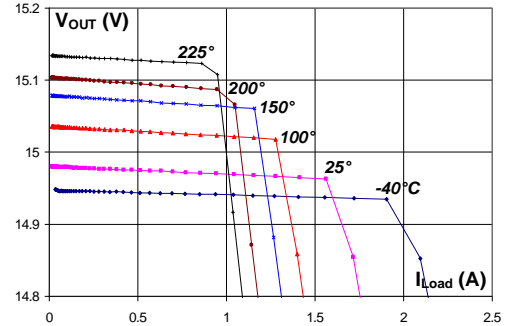

Figure 2: Zoom on figure 1

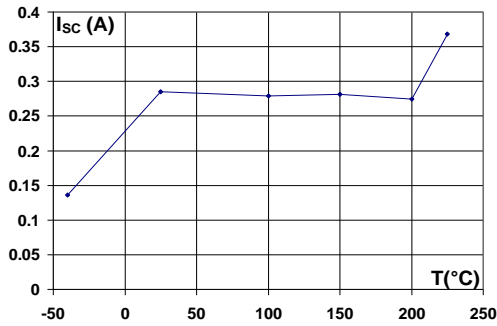

Figure 3: Typical short-circuit current vs. T°

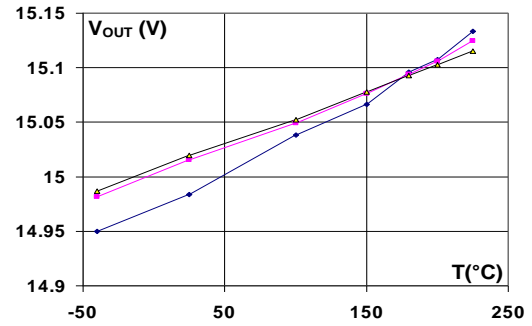

Figure 4: V_{out} vs. T° (2V dropout, 3 samples)

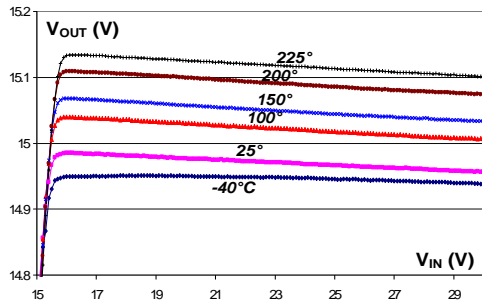

Figure 5: V_{out} vs. V_{in} over T°

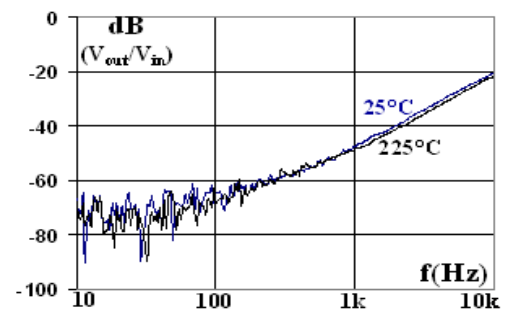

Figure 6: Input ripple rejection ($C_{out} = 1 \mu F$)

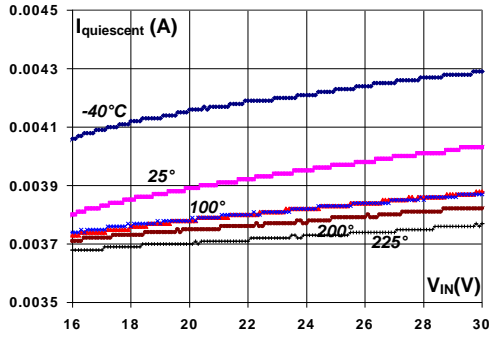

Figure 7: $I_{\text{Quiescent}}$ vs. V_{in} over T°

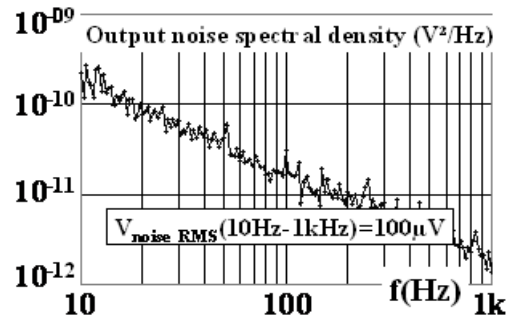

Figure 8: $S_{V_{\text{out}}}(\text{V}^2/\text{Hz})$ @ 25°C, $I_{\text{Load}}=100\text{mA}$

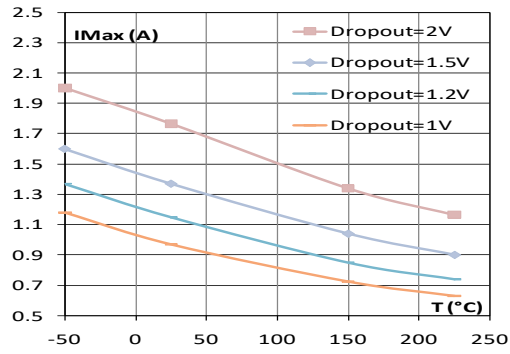
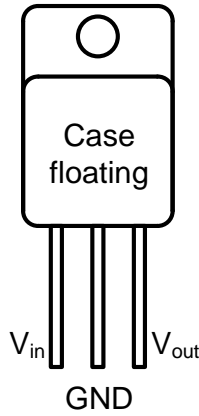

Figure 9: Typical max load current over T° vs. dropout

Packaging and Pinout (TO-254)



TO-254 (Front view)

Package Dimension

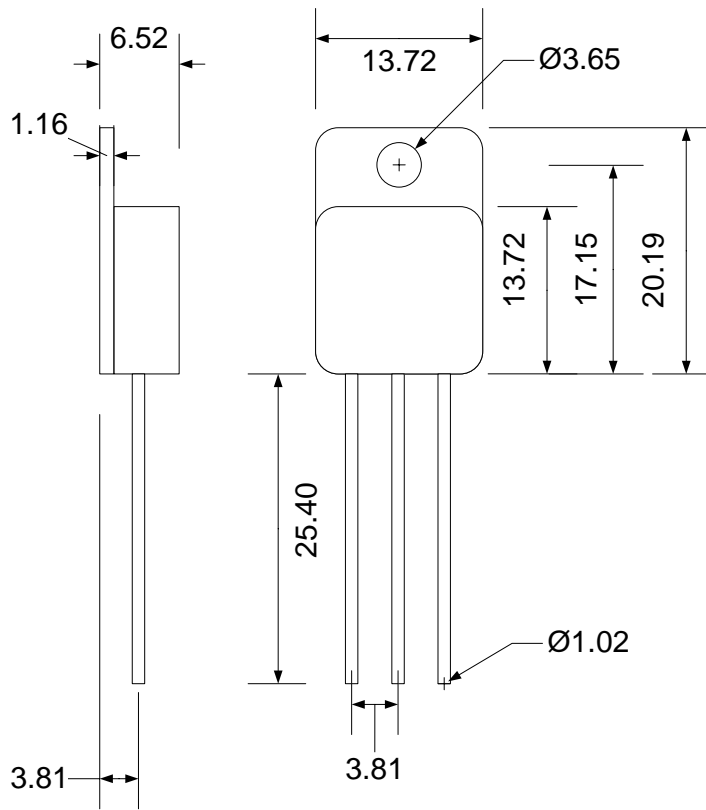

TO254 (mm +/- 10%)

Packaging and Pinout (TO-3)

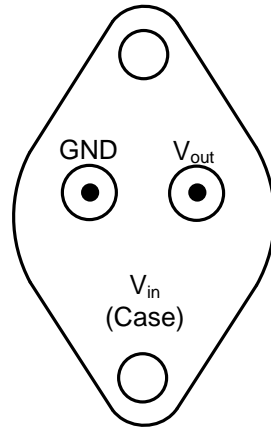

TO-3 (Bottom view)

Package Dimension

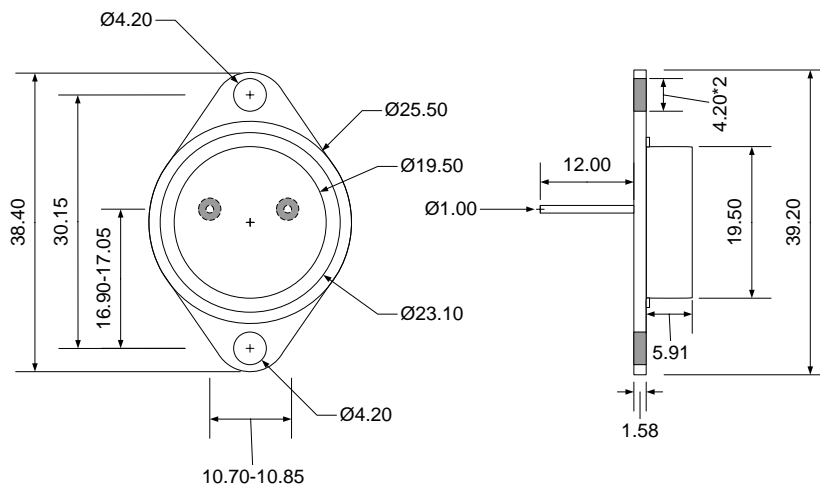

TO3 (mm +/- 10%)

Ordering Information

Standard voltages

Ordering Reference	Package	Output Voltage	Temperature Range	Marking
CHT-LDOS-033-TO254-T	Metal TO254	3.3V	-55°C to +225°C	CHT-LDOS-033
CHT-LDOS-050-TO254-T	Metal TO254	5V	-55°C to +225°C	CHT-LDOS-050
CHT-LDOS-120-TO254-T	Metal TO254	12V	-55°C to +225°C	CHT-LDOS-120
CHT-LDOS-150-TO254-T	Metal TO254	15V	-55°C to +225°C	CHT-LDOS-150

Ordering Reference	Package	Output Voltage	Temperature Range	Marking
CHT-LDOS-033-TO3-T	Metal TO3	3.3V	-55°C to +225°C	CHT-LDOS-033
CHT-LDOS-050-TO3-T	Metal TO3	5V	-55°C to +225°C	CHT-LDOS-050
CHT-LDOS-120-TO3-T	Metal TO3	12V	-55°C to +225°C	CHT-LDOS-120
CHT-LDOS-150-TO3-T	Metal TO3	15V	-55°C to +225°C	CHT-LDOS-150

Special voltages²

Ordering Reference	Package	Output Voltage	Temperature Range	Marking
CHT-LDOS-025-TO254-T	Metal TO254	2.5V	-55°C to +225°C	CHT-LDOS-025
CHT-LDOS-0525-TO254-T	Metal TO254	5.25V	-55°C to +225°C	CHT-LDOS-0525
CHT-LDOS-055-TO254-T	Metal TO254	5.5V	-55°C to +225°C	CHT-LDOS-055
CHT-LDOS-090-TO254-T	Metal TO254	9V	-55°C to +225°C	CHT-LDOS-090
CHT-LDOS-100-TO254-T	Metal TO254	10V	-55°C to +225°C	CHT-LDOS-100
CHT-LDOS-130-TO254-T	Metal TO254	13V	-55°C to +225°C	CHT-LDOS-130

Ordering Reference	Package	Output Voltage	Temperature Range	Marking
CHT-LDOS-025-TO3-T	Metal TO3	2.5V	-55°C to +225°C	CHT-LDOS-025
CHT-LDOS-0525-TO3-T	Metal TO3	5.25V	-55°C to +225°C	CHT-LDOS-0525
CHT-LDOS-055-TO3-T	Metal TO3	5.5V	-55°C to +225°C	CHT-LDOS-055
CHT-LDOS-090-TO3-T	Metal TO3	9V	-55°C to +225°C	CHT-LDOS-090
CHT-LDOS-100-TO3-T	Metal TO3	10V	-55°C to +225°C	CHT-LDOS-100
CHT-LDOS-130-TO3-T	Metal TO3	13V	-55°C to +225°C	CHT-LDOS-130

² Different lead times or MOQ may apply

Contact & Ordering

CISSOID S.A.

Headquarters and contact EMEA:	CISSOID S.A. – Rue Francqui, 3 – 1435 Mont Saint Guibert - Belgium T : +32 10 48 92 10 - F: +32 10 88 98 75 Email: mailto:sales@cissoid.com
Sales Representatives:	Visit our website: http://www.cissoid.com

Disclaimer

Neither CISSOID, nor any of its directors, employees or affiliates make any representations or extend any warranties of any kind, either express or implied, including but not limited to warranties of merchantability, fitness for a particular purpose, and the absence of latent or other defects, whether or not discoverable. In no event shall CISSOID, its directors, employees and affiliates be liable for direct, indirect, special, incidental or consequential damages of any kind arising out of the use of its circuits and their documentation, even if they have been advised of the possibility of such a damage. The circuits are provided "as is". CISSOID has no obligation to provide maintenance, support, updates, or modifications.