

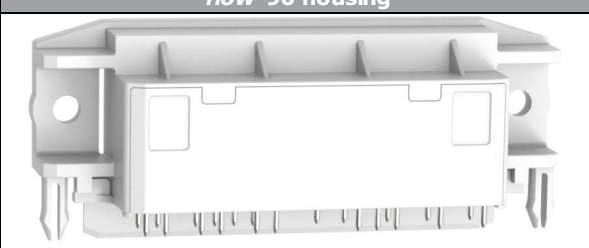
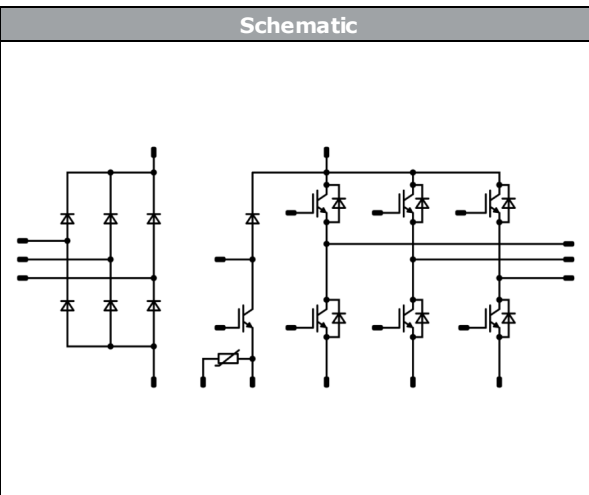

Vincotech

<i>flow 90PIM 1</i>	1200 V / 25 A
<div style="border: 1px solid black; padding: 5px; margin-bottom: 5px;"> <p style="text-align: center; background-color: #ccc; margin: 0;">Features</p> <ul style="list-style-type: none"> IGBT M7 with low V_{CEsat} and improved EMC behavior Open emitter configuration Supports design with 90° angle Clip or screw-on heat sink mounting Built-in NTC </div> <div style="border: 1px solid black; padding: 5px; margin-bottom: 5px;"> <p style="text-align: center; background-color: #ccc; margin: 0;">Target applications</p> <ul style="list-style-type: none"> Industrial Drives </div> <div style="border: 1px solid black; padding: 5px;"> <p style="text-align: center; background-color: #ccc; margin: 0;">Types</p> <ul style="list-style-type: none"> 10-R112PMA025M7-P630A70 </div>	<div style="border: 1px solid black; padding: 5px; margin-bottom: 5px;"> <p style="text-align: center; background-color: #ccc; margin: 0;"><i>flow 90 housing</i></p>  </div> <div style="border: 1px solid black; padding: 5px;"> <p style="text-align: center; background-color: #ccc; margin: 0;">Schematic</p>  </div>

Maximum Ratings

$T_j = 25\text{ °C}$, unless otherwise specified

Parameter	Symbol	Condition	Value	Unit
Rectifier Diode				
Peak Repetitive Reverse Voltage	V_{RRM}		1600	V
Continuous (direct) forward current	I_F		25	A
Surge (non-repetitive) forward current	I_{FSM}	50 Hz Single Half Sine Wave $t_p = 10\text{ ms}$ $T_j = 150\text{ °C}$	200	A
Surge current capability	I^2t		200	A^2s
Total power dissipation	P_{tot}	$T_j = T_{jmax}$ $T_s = 80\text{ °C}$	44	W
Maximum Junction Temperature	T_{jmax}		150	°C



Vincotech

Maximum Ratings

$T_j = 25\text{ °C}$, unless otherwise specified

Parameter	Symbol	Condition	Value	Unit
Inverter Switch				
Collector-emitter voltage	V_{CES}		1200	V
Collector current	I_C		25	A
Repetitive peak collector current	I_{CRM}	t_p limited by T_{jmax}	50	A
Total power dissipation	P_{tot}	$T_j = T_{jmax}$ $T_s = 80\text{ °C}$	82	W
Gate-emitter voltage	V_{GES}		± 20	V
Maximum junction temperature	T_{jmax}		175	°C

Inverter Diode				
Peak repetitive reverse voltage	V_{RRM}		1200	V
Continuous (direct) forward current	I_F		25	A
Repetitive peak forward current	I_{FRM}	T_j limited by T_{jmax}	50	A
Total power dissipation	P_{tot}	$T_j = T_{jmax}$ $T_s = 80\text{ °C}$	62	W
Maximum junction temperature	T_{jmax}		175	°C

Brake Switch				
Collector-emitter voltage	V_{CES}		1200	V
Collector current	I_C		15	A
Repetitive peak collector current	I_{CRM}	t_p limited by T_{jmax}	30	A
Total power dissipation	P_{tot}	$T_j = T_{jmax}$ $T_s = 80\text{ °C}$	60	W
Gate-emitter voltage	V_{GES}		± 20	V
Maximum junction temperature	T_{jmax}		175	°C

Brake Diode				
Peak repetitive reverse voltage	V_{RRM}		1200	V
Continuous (direct) forward current	I_F		15	A
Repetitive peak forward current	I_{FRM}	T_j limited by T_{jmax}	30	A
Total power dissipation	P_{tot}	$T_j = T_{jmax}$ $T_s = 80\text{ °C}$	45	W
Maximum junction temperature	T_{jmax}		175	°C



Vincotech

Maximum Ratings

$T_j = 25\text{ °C}$, unless otherwise specified

Parameter	Symbol	Condition	Value	Unit
-----------	--------	-----------	-------	------

Module Properties

Thermal Properties

Storage temperature	T_{stg}		-40...+125	°C
Operation temperature under switching condition	T_{top}		-40...(T _{max} - 25)	°C

Isolation Properties

Isolation voltage	V_{isol}	DC Test Voltage* $t_p = 2\text{ s}$	6000	V
		AC Voltage $t_p = 1\text{ min}$	2500	V
Creepage distance			min. 12,7	mm
Clearance			11,84	mm
Comparative Tracking Index	CTI		> 200	

*100 % tested in production



Characteristic Values

Parameter	Symbol	Conditions					Value			Unit
		V_{GE} [V] V_{GS} [V]	V_{CE} [V] V_{DS} [V] V_F [V]	I_C [A] I_D [A] I_F [A]	T_j [°C]	Min	Typ	Max		
Rectifier Diode										
Static										
Forward voltage	V_F			25	25 125		1,22 1,21	1,75		V
Reverse leakage current	I_r		1600		25 145			50 1100		μ A
Thermal										
Thermal resistance junction to sink	$R_{th(j-s)}$	$\lambda_{paste} = 3,4$ W/mK (PSX)					1,59			K/W



Vincotech

Characteristic Values

Parameter	Symbol	Conditions					Value			Unit
		V_{GS} [V]	V_{GE} [V]	V_{DS} [V]	I_D [A]	T_j [°C]	Min	Typ	Max	
Inverter Switch										
Static										
Gate-emitter threshold voltage	$V_{GE(th)}$	$V_{GE} = V_{CE}$			0,0025	25	5,4	6	6,6	V
Collector-emitter saturation voltage	V_{CESat}		15		25	25 125 150		1,65 1,89 1,95	2,15	V
Collector-emitter cut-off current	I_{CES}		0	1200		25			70	μA
Gate-emitter leakage current	I_{GES}		20	0		25			500	nA
Internal gate resistance	r_g							none		Ω
Input capacitance	C_{ies}							4800		pF
Output capacitance	C_{oes}		0	10		25		170		
Reverse transfer capacitance	C_{res}							57		
Gate charge	Q_g		15	600	25	25		180		nC
Thermal										
Thermal resistance junction to sink	$R_{th(j-s)}$	$\lambda_{paste} = 3,4$ W/mK (PSX)						1,16		K/W
Dynamic										
Turn-on delay time	$t_{d(on)}$	$R_{goff} = 16$ Ω $R_{gon} = 16$ Ω	±15	600	25	25		147		ns
Rise time	t_r					125		149		
Turn-off delay time	$t_{d(off)}$					150		145		
Fall time	t_f					25		29		
Turn-on energy (per pulse)	E_{on}					125		33		
Turn-off energy (per pulse)	E_{off}	150		34						
		25		171						
		125		191						
		150		196						
		25		95						
		125		110						
		150		115						
		25		2,06						
		125		2,66						
		150		2,82						
		25		1,67						
		125		2,18						
		150		2,29						



Characteristic Values

Parameter	Symbol	Conditions					Value			Unit
		V_{GE} [V] V_{GS} [V]	V_{CE} [V] V_{DS} [V] V_F [V]	I_C [A] I_D [A] I_F [A]	T_j [°C]	Min	Typ	Max		

Inverter Diode

Static

Forward voltage	V_F			25	25 125 150		1,63 1,70 1,69	2,1		V
Reverse leakage current	I_R			1200	25			35		μA

Thermal

Thermal resistance junction to sink	$R_{th(j-s)}$	$\lambda_{paste} = 3,4$ W/mK (PSX)					1,54			K/W
-------------------------------------	---------------	---------------------------------------	--	--	--	--	------	--	--	-----

Dynamic

Peak recovery current	I_{RRM}				25 125 150		21 23 23			A
Reverse recovery time	t_{rr}				25 125 150		254 367 404			ns
Recovered charge	Q_r	$di/dt = 645$ A/μs $di/dt = 673$ A/μs $di/dt = 633$ A/μs	±15	600	25	25 125 150	2,54 3,88 4,28			μC
Reverse recovered energy	E_{rec}				25 125 150		0,88 1,45 1,61			mWs
Peak rate of fall of recovery current	$(di_{rr}/dt)_{max}$				25 125 150		217 134 132			A/μs



Vincotech

Characteristic Values

Parameter	Symbol	Conditions					Value			Unit
		V_{GS} [V]	V_{GE} [V]	V_{DS} [V]	I_D [A]	T_j [°C]	Min	Typ	Max	
Brake Switch										
Static										
Gate-emitter threshold voltage	$V_{GE(th)}$	$V_{GE} = V_{CE}$			0,0015	25	5,4	6	6,6	V
Collector-emitter saturation voltage	V_{CESat}		15		15	25 125 150		1,70 1,95 2,01	2,15	V
Collector-emitter cut-off current	I_{CES}		0	1200		25			60	μA
Gate-emitter leakage current	I_{GES}		20	0		25			500	nA
Internal gate resistance	r_g							none		Ω
Input capacitance	C_{ies}							2900		pF
Output capacitance	C_{oes}		0	10		25		120		
Reverse transfer capacitance	C_{res}							34		
Gate charge	Q_g		15	600	15	25		1100		nC
Thermal										
Thermal resistance junction to sink	$R_{th(j-s)}$	$\lambda_{paste} = 3,4$ W/mK (PSX)						1,60		K/W
Dynamic										
Turn-on delay time	$t_{d(on)}$					25 125 150		96 85 78		ns
Rise time	T_r	$R_{goff} = 32$ Ω $R_{gon} = 32$ Ω				25 125 150		61 62 65		
Turn-off delay time	$t_{d(off)}$		15/0	600	15	25 125 150		296 324 331		
Fall time	t_f					25 125 150		97 116 120		
Turn-on energy (per pulse)	E_{on}	$Q_{t-FWD} = 1,5$ μC $Q_{t-FWD} = 2,4$ μC $Q_{t-FWD} = 2,7$ μC				25 125 150		1,65 2,05 2,17		mWs
Turn-off energy (per pulse)	E_{off}					25 125 150		1,00 1,34 1,43		



Vincotech

Characteristic Values

Parameter	Symbol	Conditions					Value			Unit
		V_{GE} [V] V_{GS} [V]	V_{CE} [V] V_{DS} [V] V_F [V]	I_C [A] I_D [A] I_F [A]	T_j [°C]	Min	Typ	Max		
Brake Diode										
Static										
Forward voltage	V_F			15	25 125 150		1,63 1,74 1,73	2,1		V
Reverse leakage current	I_R		1200		25			30		μA
Thermal										
Thermal resistance junction to sink	$R_{th(j-s)}$	$\lambda_{paste} = 3,4$ W/mK (PSX)						2,11		K/W
Dynamic										
Peak recovery current	I_{RRM}				25 125 150		10 11 11			A
Reverse recovery time	T_{rr}				25 125 150		283 420 463			ns
Recovered charge	Q_r	$di/dt = 205$ A/μs $di/dt = 185$ A/μs $di/dt = 188$ A/μs	15/0	600	15	25 125 150	1,49 2,44 2,68			μC
Reverse recovered energy	E_{rec}				25 125 150		0,505 0,916 1,01			mWs
Peak rate of fall of recovery current	$(di_{rr}/dt)_{max}$				25 125 150		75 51 47			A/μs
Thermistor										
Rated resistance	R				25		22			kΩ
Deviation of R_{100}	$\Delta_{R/R}$	$R_{100} = 1486$ Ω			100	-12		+14		%
Power dissipation	P				25		200			mW
Power dissipation constant					25		2			mW/K
B-value	$B_{(25/50)}$	Tol. ±3%			25		3950			K
B-value	$B_{(25/100)}$	Tol. ±3%			25		3998			K
Vincotech NTC Reference								B		



Rectifier Diode Characteristics

figure 1. Rectifier
Typical forward characteristics

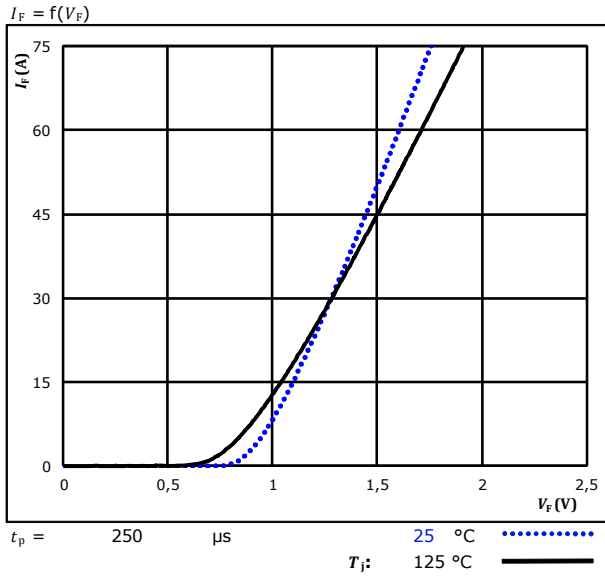
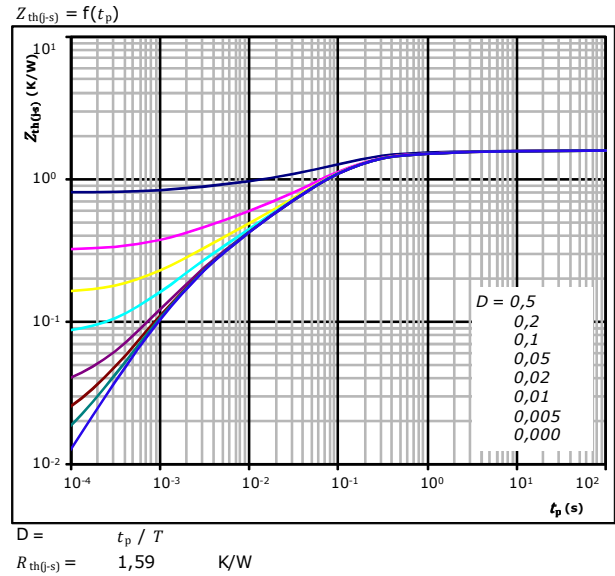

figure 2. Rectifier
Transient thermal impedance as a function of pulse width



Diode thermal model values

R (K/W)	τ (s)
3,44E-02	9,66E+00
1,12E-01	1,22E+00
5,81E-01	1,45E-01
4,89E-01	5,05E-02
2,38E-01	9,26E-03
1,22E-01	1,79E-03
1,22E-01	1,79E-03
1,81E-02	7,88E-04



Inverter Switch Characteristics

figure 1. IGBT

Typical output characteristics

$$I_C = f(V_{CE})$$

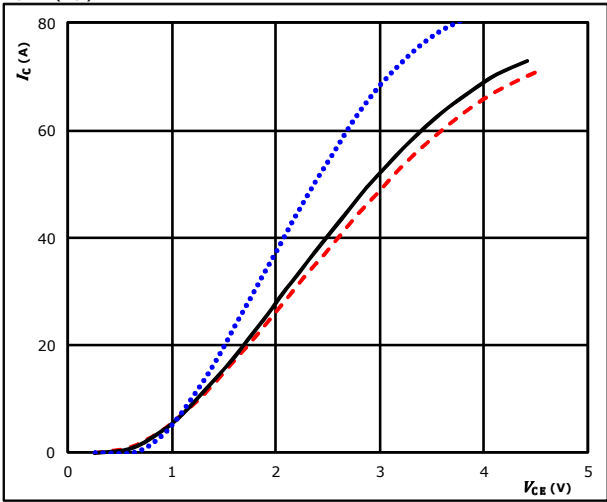

$t_p = 250 \mu s$ $T_j: 25 \text{ }^\circ C$ (dotted blue)
 $V_{GE} = 15 V$ $T_j: 125 \text{ }^\circ C$ (solid black)
 $T_j: 150 \text{ }^\circ C$ (dashed red)

figure 2. IGBT

Typical output characteristics

$$I_C = f(V_{CE})$$

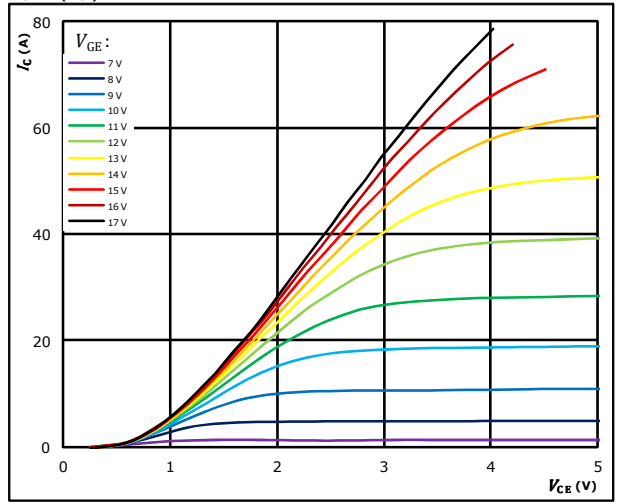

$t_p = 250 \mu s$ $T_j = 125 \text{ }^\circ C$
 V_{GE} from 7 V to 17 V in steps of 1 V

figure 3. IGBT

Typical transfer characteristics

$$I_C = f(V_{GE})$$

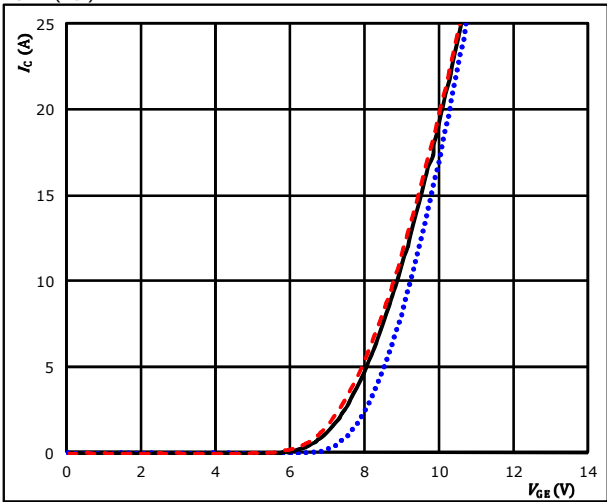

$t_p = 100 \mu s$ $T_j: 25 \text{ }^\circ C$ (dotted blue)
 $V_{CE} = 10 V$ $T_j: 125 \text{ }^\circ C$ (solid black)
 $T_j: 150 \text{ }^\circ C$ (dashed red)

figure 4. IGBT

Transient thermal impedance as function of pulse duration

$$Z_{th(\theta-s)} = f(t_p)$$

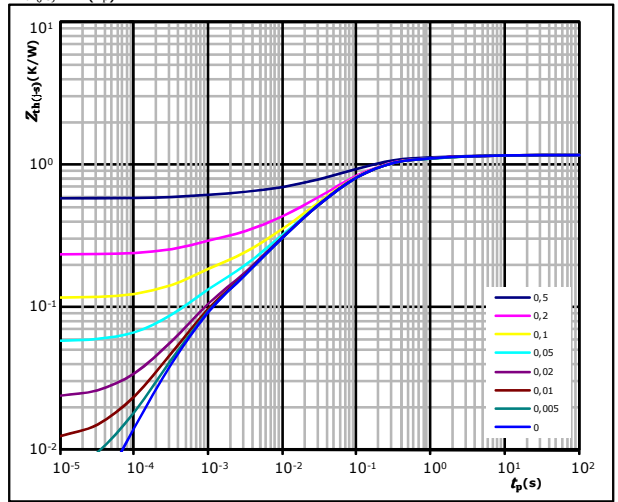

$D = t_p / T$
 $R_{th(\theta-s)} = 1,16 \text{ K/W}$

IGBT thermal model values

R (K/W)	τ (s)
5,33E-02	3,54E+00
1,07E-01	5,75E-01
5,05E-01	1,04E-01
2,68E-01	3,30E-02
1,51E-01	7,35E-03
7,80E-02	6,52E-04



Inverter Switch Characteristics

figure 5. IGBT

Safe operating area

$$I_C = f(V_{CE})$$

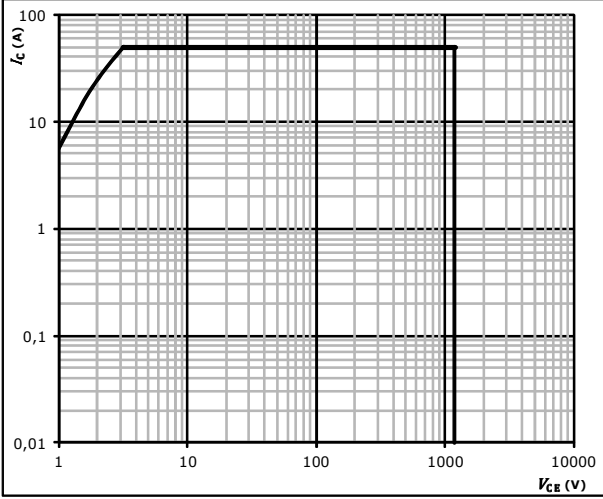

- $D =$ single pulse
- $T_s =$ 80 °C
- $V_{GE} =$ ±15 V
- $T_j =$ T_{jmax}



Inverter Diode Characteristics

figure 1. FWD

Typical forward characteristics

$$I_F = f(V_F)$$

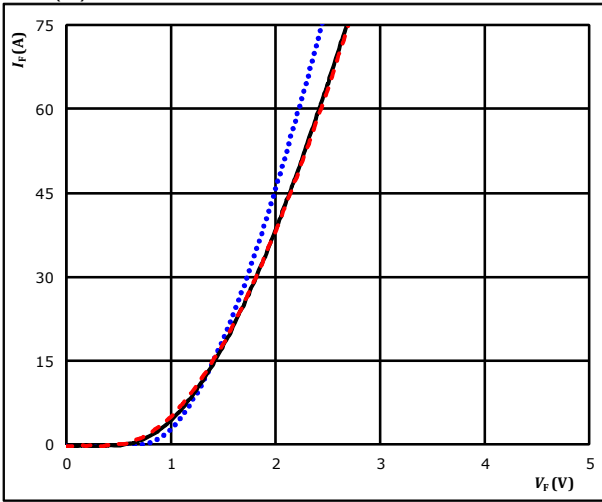

$t_p = 250 \mu s$

T_j : 25 °C (dotted blue line)
125 °C (solid black line)
150 °C (dashed red line)

figure 2. FWD

Transient thermal impedance as a function of pulse width

$$Z_{th(j-s)} = f(t_p)$$

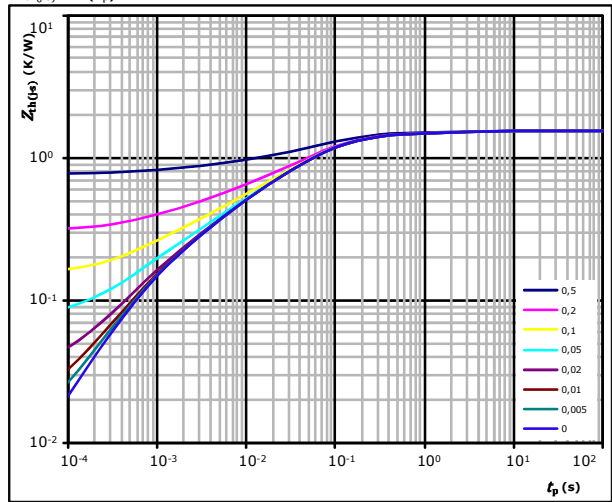

$D = t_p / T$

$R_{th(j-s)} = 1,54 \text{ K/W}$

FWD thermal model values

R (K/W)	τ (s)
4,69E-02	5,05E+00
1,06E-01	7,09E-01
5,57E-01	1,01E-01
4,68E-01	3,22E-02
2,35E-01	5,52E-03
8,77E-02	1,01E-03
4,01E-02	5,52E-04



Brake Switch Characteristics

figure 1. IGBT

Typical output characteristics

$I_C = f(V_{CE})$

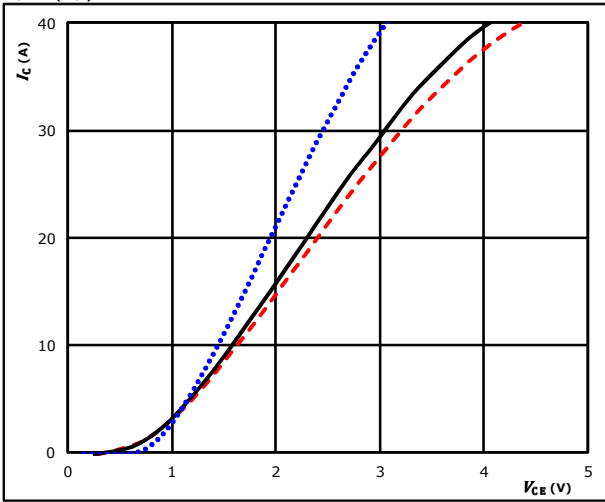

$t_p = 250 \mu s$ $T_j: 25 \text{ }^\circ C$
 $V_{GE} = 15 \text{ V}$ $T_j: 125 \text{ }^\circ C$ ———
 $T_j: 150 \text{ }^\circ C$ - - - -

figure 2. IGBT

Typical output characteristics

$I_C = f(V_{CE})$

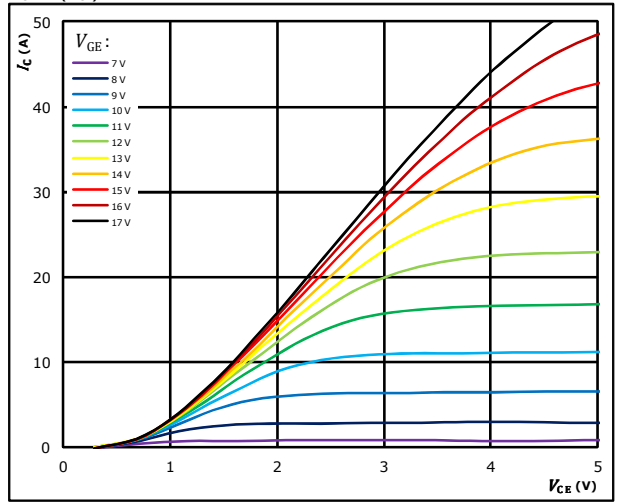

$t_p = 250 \mu s$ $T_j = 150 \text{ }^\circ C$
 V_{GE} from 7 V to 17 V in steps of 1 V

figure 3. IGBT

Typical transfer characteristics

$I_C = f(V_{GE})$

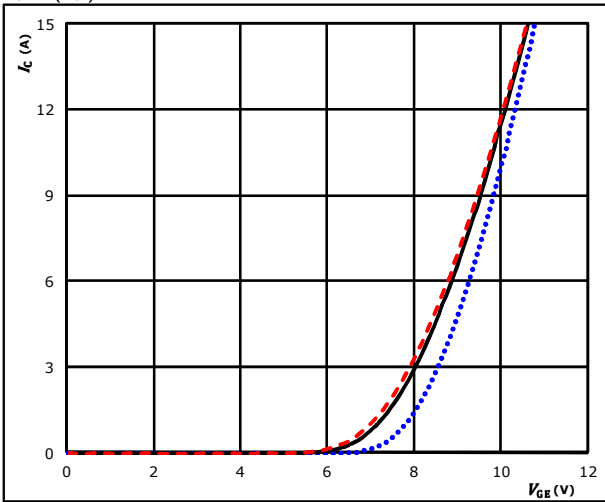

$t_p = 100 \mu s$ $T_j: 25 \text{ }^\circ C$
 $V_{CE} = 10 \text{ V}$ $T_j: 125 \text{ }^\circ C$ ———
 $T_j: 150 \text{ }^\circ C$ - - - -

figure 4. IGBT

Transient thermal impedance as function of pulse duration

$Z_{th(j-s)} = f(t_p)$

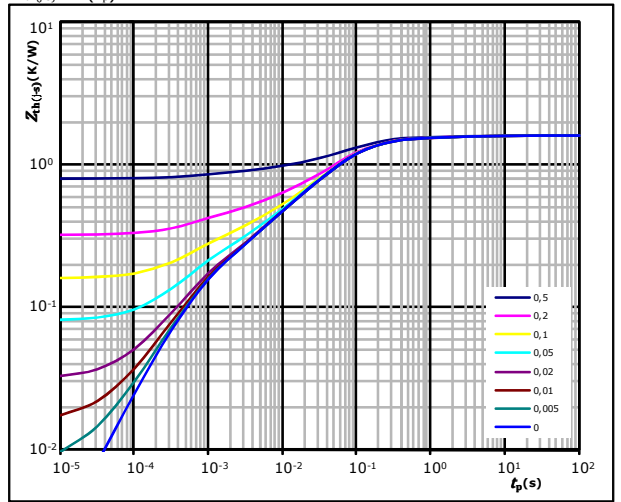

$D = t_p / T$
 $R_{th(j-s)} = 1,60 \text{ K/W}$
 IGBT thermal model values

R (K/W)	τ (s)
4,90E-02	4,40E+00
1,40E-01	5,34E-01
8,04E-01	8,02E-02
2,98E-01	2,57E-02
1,69E-01	5,09E-03
1,35E-01	6,41E-04



Vincotech

Brake Switch Characteristics

figure 5. IGBT

Safe operating area

$$I_C = f(V_{CE})$$

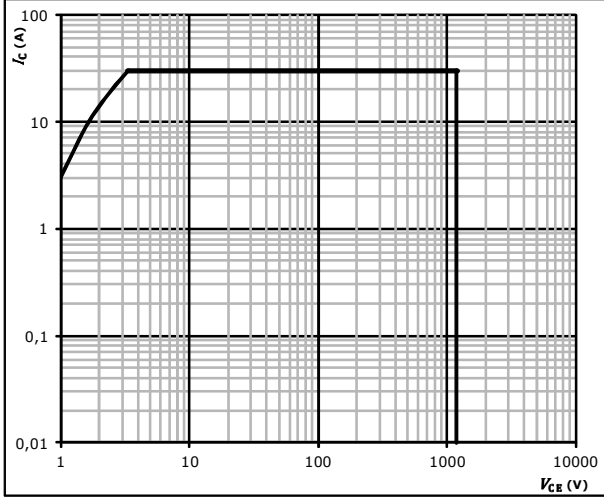

$D =$ single pulse
 $T_s =$ 80 °C
 $V_{GE} =$ ±15 V
 $T_j = T_{jmax}$



Brake Diode Characteristics

figure 1. FWD

Typical forward characteristics

$$I_F = f(V_F)$$

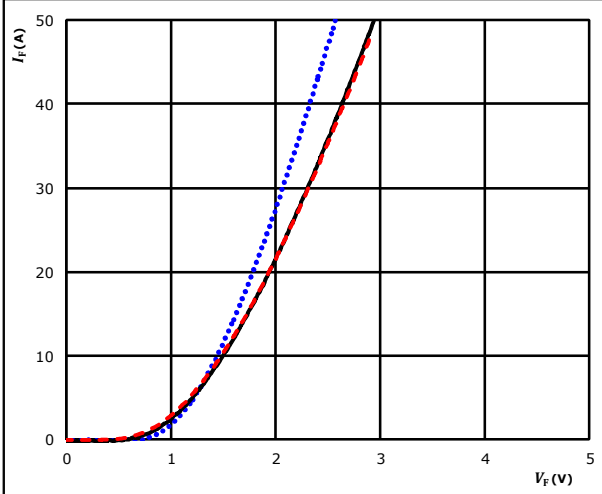

$t_p = 250 \mu s$
 T_j : 25 °C
 125 °C ———
 150 °C - - - -

figure 2. FWD

Transient thermal impedance as a function of pulse width

$$Z_{th(j-s)} = f(t_p)$$

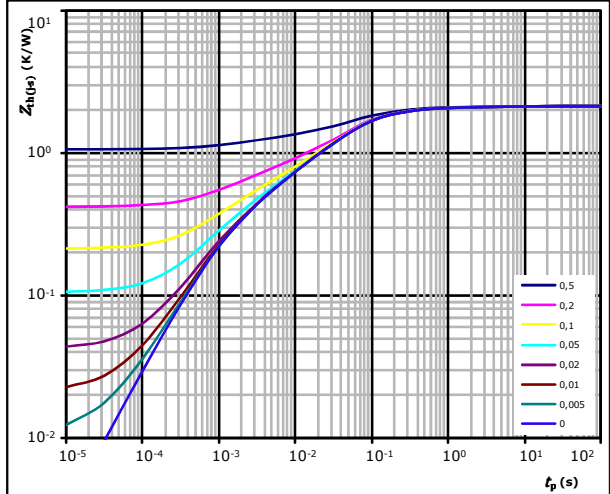

$D = t_p / T$
 $R_{th(j-s)} = 2,11 \text{ K/W}$
 FWD thermal model values

R (K/W)	τ (s)
8,99E-02	2,33E+00
4,04E-01	1,91E-01
1,05E+00	4,49E-02
3,39E-01	6,08E-03
2,29E-01	1,02E-03

Thermistor Characteristics

figure 1. Thermistor

Typical NTC characteristic
as a function of temperature

$$R = f(T)$$

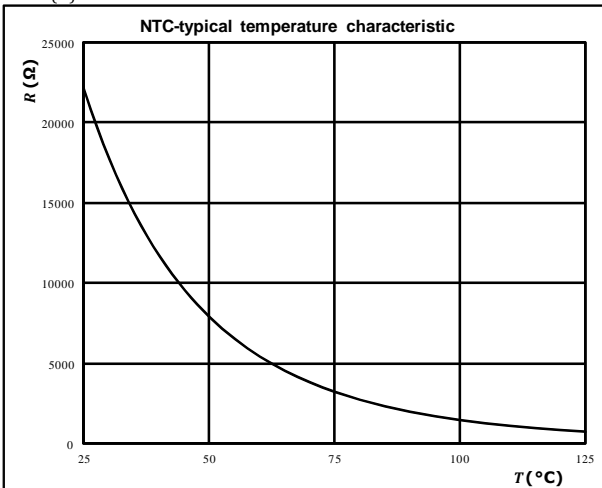



Inverter Switching Characteristics

figure 1. IGBT

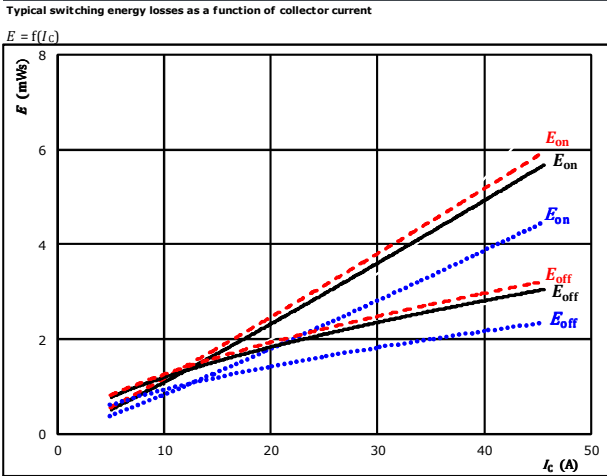

With an inductive load at

$V_{CE} = 600$ V	$T_j: 25$ °C
$V_{GE} = \pm 15$ V	125 °C	————
$R_{g\text{on}} = 16$ Ω	150 °C	- - - -
$R_{g\text{off}} = 16$ Ω		

figure 2. IGBT

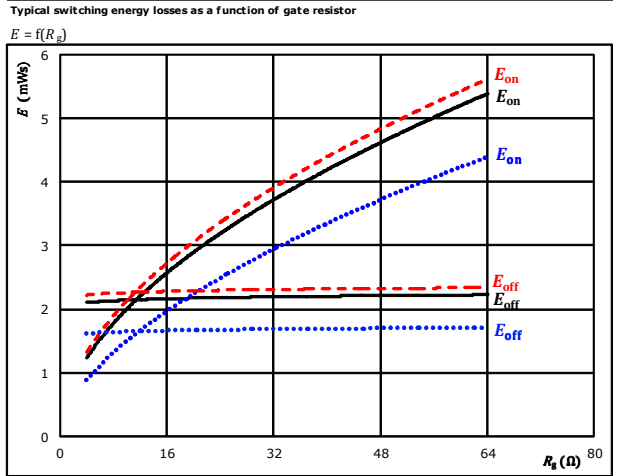

With an inductive load at

$V_{CE} = 600$ V	$T_j: 25$ °C
$V_{GE} = \pm 15$ V	125 °C	————
$I_C = 25$ A	150 °C	- - - -

figure 3. FWD

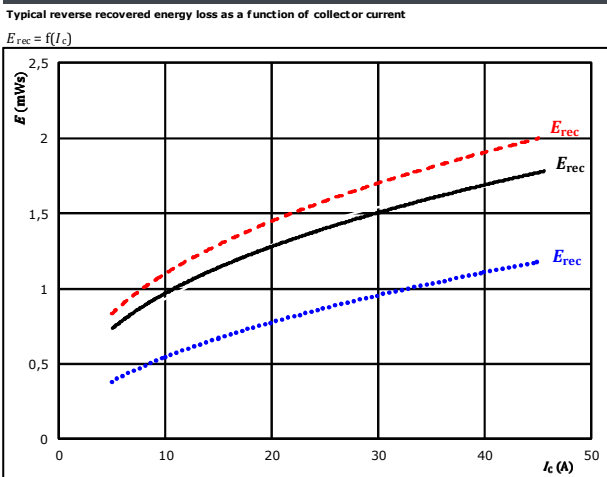

With an inductive load at

$V_{CE} = 600$ V	$T_j: 25$ °C
$V_{GE} = \pm 15$ V	125 °C	————
$R_{g\text{on}} = 16$ Ω	150 °C	- - - -

figure 4. FWD

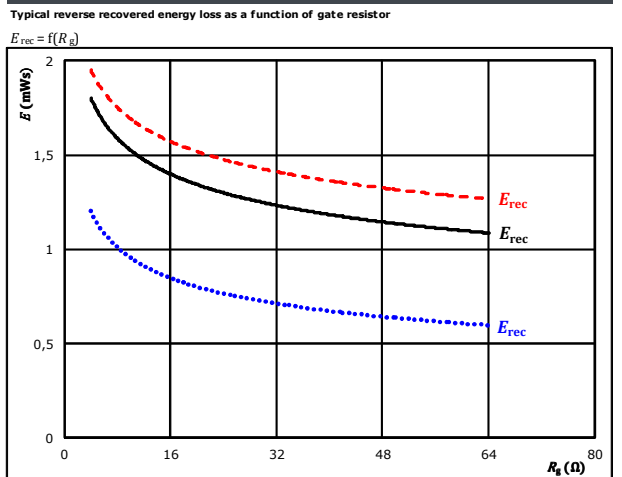

With an inductive load at

$V_{CE} = 600$ V	$T_j: 25$ °C
$V_{GE} = \pm 15$ V	125 °C	————
$I_C = 25$ A	150 °C	- - - -



Vincotech

Inverter Switching Characteristics

figure 5. IGBT

Typical switching times as a function of collector current

$$t = f(I_c)$$

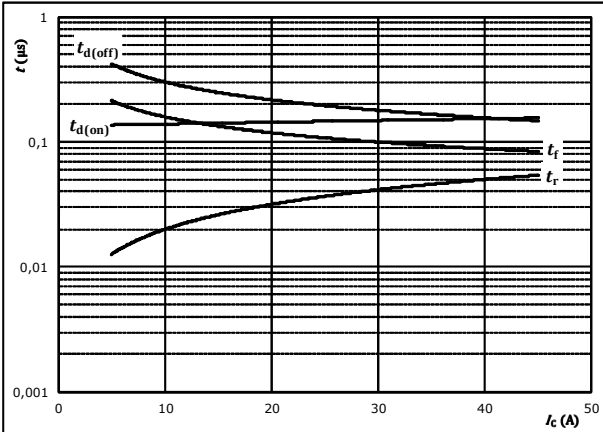

With an inductive load at

$T_j =$	150	°C
$V_{CE} =$	600	V
$V_{GE} =$	±15	V
$R_{g(on)} =$	16	Ω
$R_{g(off)} =$	16	Ω

figure 6. IGBT

Typical switching times as a function of gate resistor

$$t = f(R_g)$$

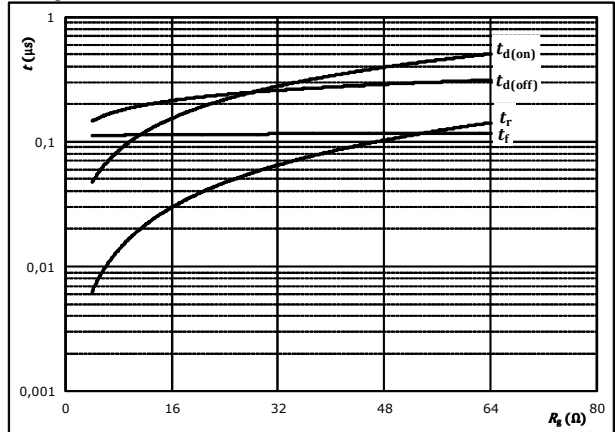

With an inductive load at

$T_j =$	150	°C
$V_{CE} =$	600	V
$V_{GE} =$	±15	V
$I_c =$	25	A

figure 7. FWD

Typical reverse recovery time as a function of collector current

$$t_{rr} = f(I_c)$$

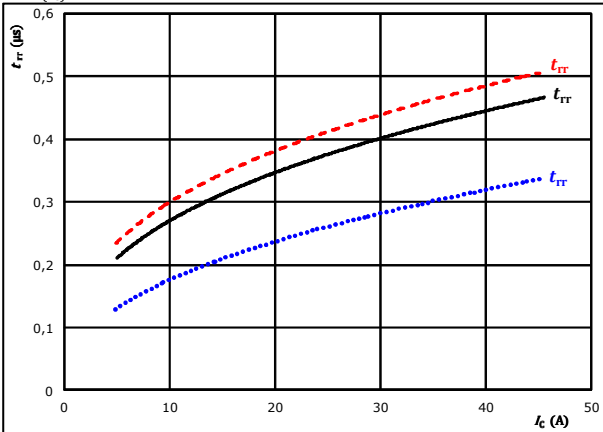

At	$V_{CE} =$	600	V	$T_j:$	25 °C
	$V_{GE} =$	±15	V		125 °C	————
	$R_{g(on)} =$	16	Ω		150 °C	-----

figure 8. FWD

Typical reverse recovery time as a function of IGBT turn on gate resistor

$$t_{rr} = f(R_{g(on)})$$

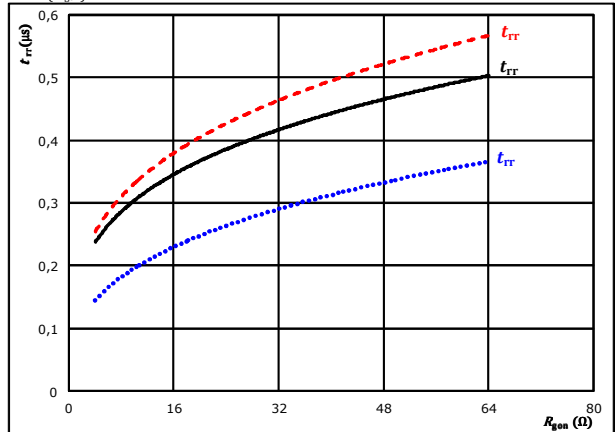

At	$V_{CE} =$	600	V	$T_j:$	25 °C
	$V_{GE} =$	±15	V		125 °C	————
	$I_c =$	25	A		150 °C	-----



Inverter Switching Characteristics

figure 9. FWD

Typical recovered charge as a function of collector current

$$Q_r = f(I_c)$$

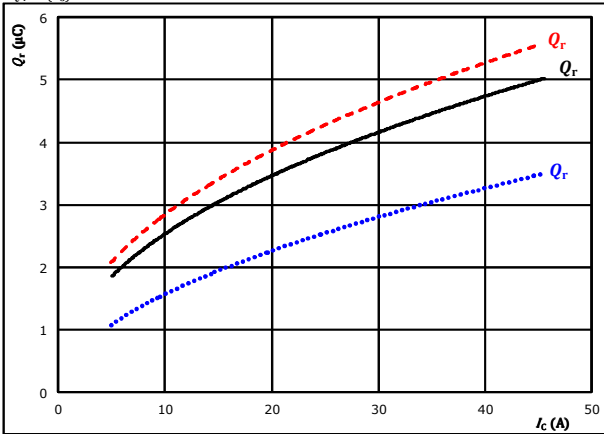

At $V_{CE} = 600$ V
 $V_{GE} = \pm 15$ V
 $R_{gdn} = 16$ Ω
 $T_j: 25$ °C (dotted blue line)
 125 °C (solid black line)
 150 °C (dashed red line)

figure 10. FWD

Typical recovered charge as a function of IGBT turn on gate resistor

$$Q_r = f(R_{gdn})$$

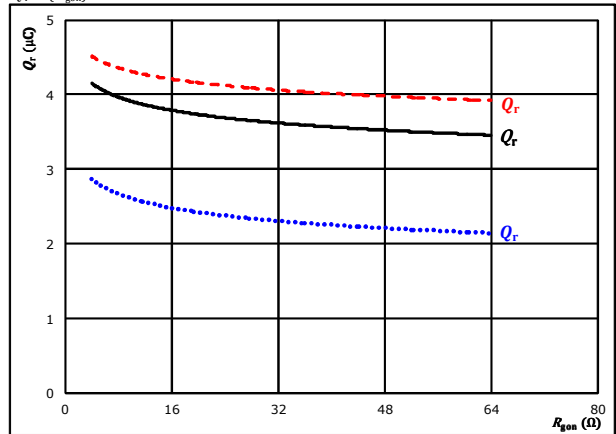

At $V_{CE} = 600$ V
 $V_{GE} = \pm 15$ V
 $I_c = 25$ A
 $T_j: 25$ °C (dotted blue line)
 125 °C (solid black line)
 150 °C (dashed red line)

figure 11. FWD

Typical peak reverse recovery current as a function of collector current

$$I_{RM} = f(I_c)$$

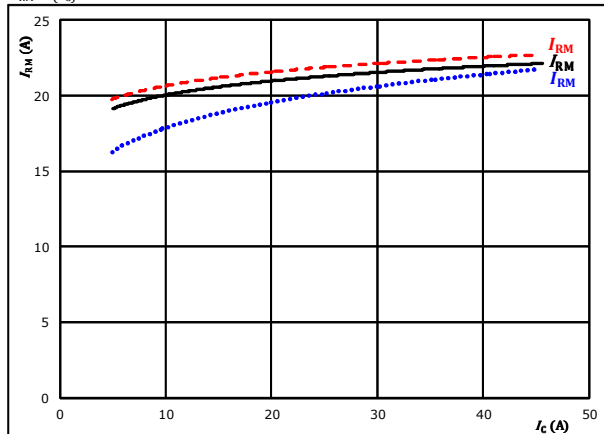

At $V_{CE} = 600$ V
 $V_{GE} = \pm 15$ V
 $R_{gdn} = 16$ Ω
 $T_j: 25$ °C (dotted blue line)
 125 °C (solid black line)
 150 °C (dashed red line)

figure 12. FWD

Typical peak reverse recovery current as a function of IGBT turn on gate resistor

$$I_{RM} = f(R_{gdn})$$

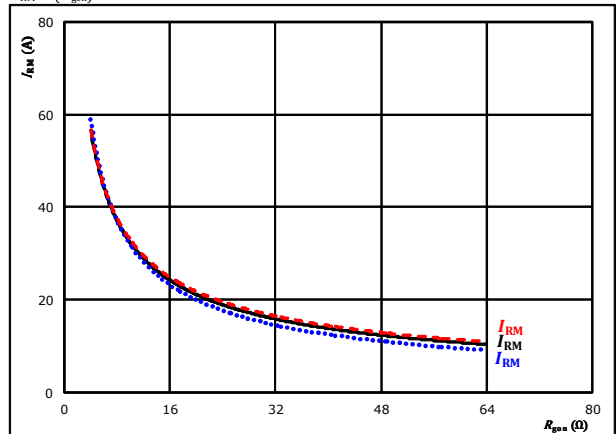

At $V_{CE} = 600$ V
 $V_{GE} = \pm 15$ V
 $I_c = 25$ A
 $T_j: 25$ °C (dotted blue line)
 125 °C (solid black line)
 150 °C (dashed red line)



Inverter Switching Characteristics

figure 13. FWD

Typical rate of fall of forward and reverse recovery current as a function of collector current
 $di_f/dt, di_{rr}/dt = f(I_c)$

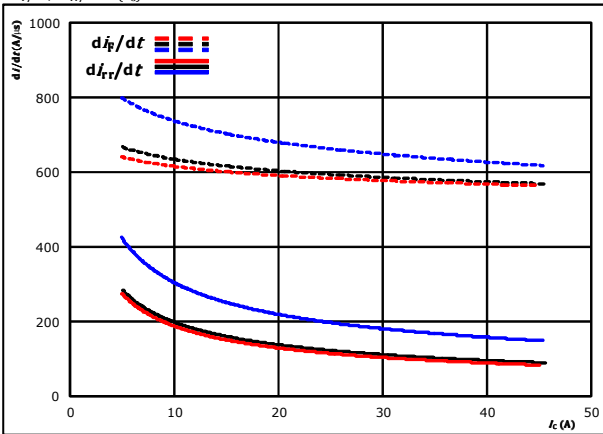

At $V_{CE} = 600$ V $T_j = 25$ °C (.....)
 $V_{GE} = \pm 15$ V $T_j = 125$ °C (—)
 $R_{g0n} = 16$ Ω $T_j = 150$ °C (---)

figure 14. FWD

Typical rate of fall of forward and reverse recovery current as a function of IGBT turn on gate resistor
 $di_f/dt, di_{rr}/dt = f(R_{g0n})$

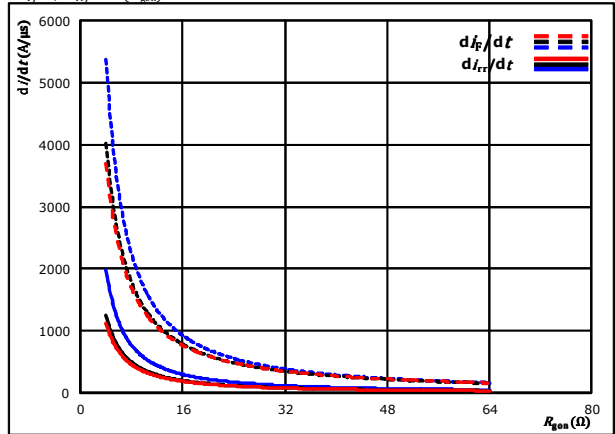

At $V_{CE} = 600$ V $T_j = 25$ °C (.....)
 $V_{GE} = \pm 15$ V $T_j = 125$ °C (—)
 $I_c = 25$ A $T_j = 150$ °C (---)

figure 15. IGBT

Reverse bias safe operating area
 $I_c = f(V_{CE})$

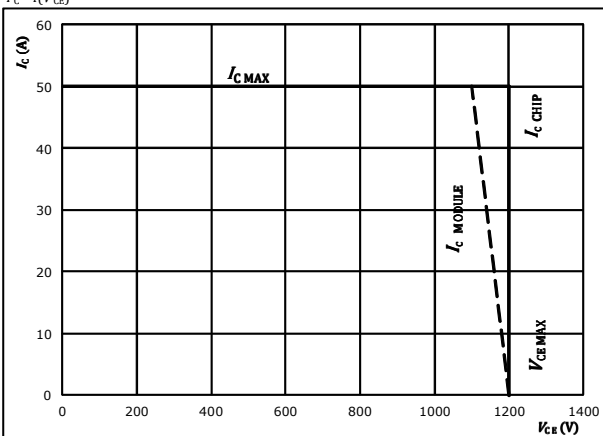

At $T_j = 175$ °C
 $R_{g0n} = 16$ Ω
 $R_{g0ff} = 16$ Ω



Inverter Switching Definitions

General conditions

T_j	=	125 °C
R_{gon}	=	16 Ω
R_{goff}	=	16 Ω

figure 1. IGBT

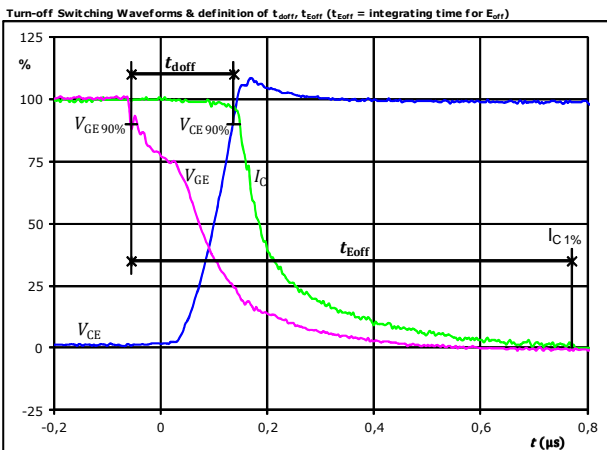

$V_{GE}(0\%) =$	-15	V
$V_{GE}(100\%) =$	15	V
$V_C(100\%) =$	600	V
$I_C(100\%) =$	25	A
$t_{doff} =$	0,191	μs
$t_{Eoff} =$	0,826	μs

figure 2. IGBT

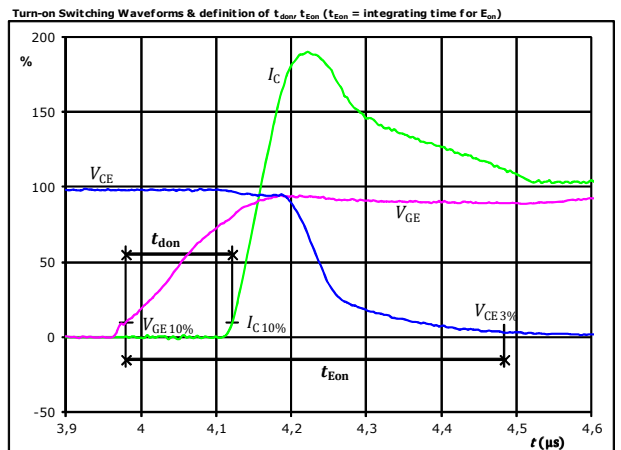

$V_{GE}(0\%) =$	-15	V
$V_{GE}(100\%) =$	15	V
$V_C(100\%) =$	600	V
$I_C(100\%) =$	25	A
$t_{don} =$	0,149	μs
$t_{Eon} =$	0,504	μs

figure 3. IGBT

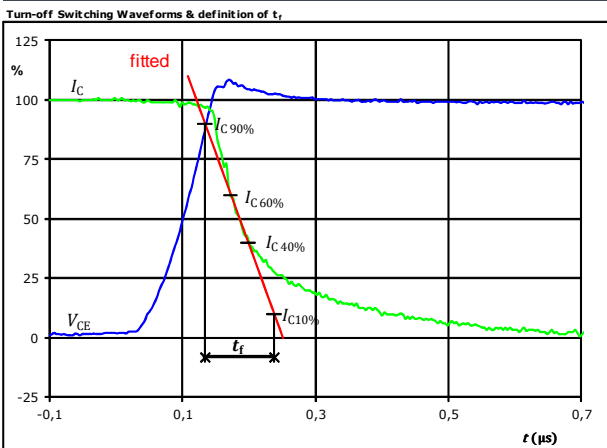

$V_C(100\%) =$	600	V
$I_C(100\%) =$	25	A
$t_f =$	0,110	μs

figure 4. IGBT

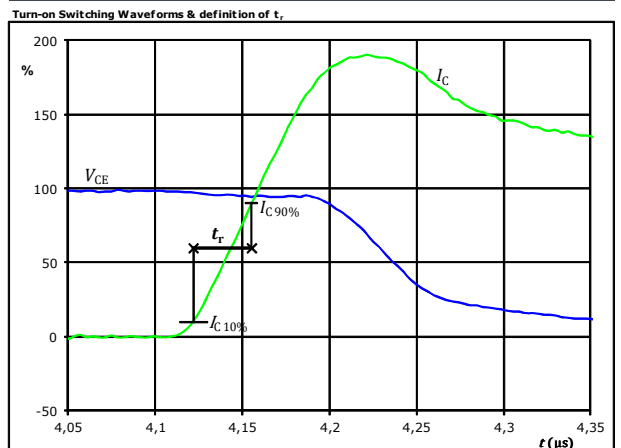

$V_C(100\%) =$	600	V
$I_C(100\%) =$	25	A
$t_r =$	0,033	μs



Vincotech

Inverter Switching Characteristics

figure 5. IGBT

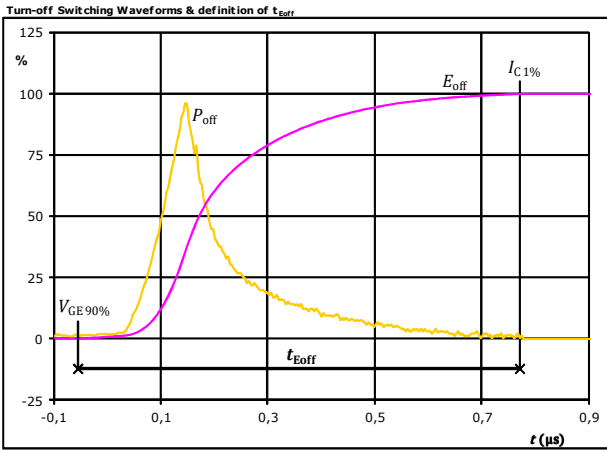

$P_{off}(100\%) = 15,13$ kW
 $E_{off}(100\%) = 2,18$ mJ
 $t_{Eoff} = 0,83$ µs

figure 6. IGBT

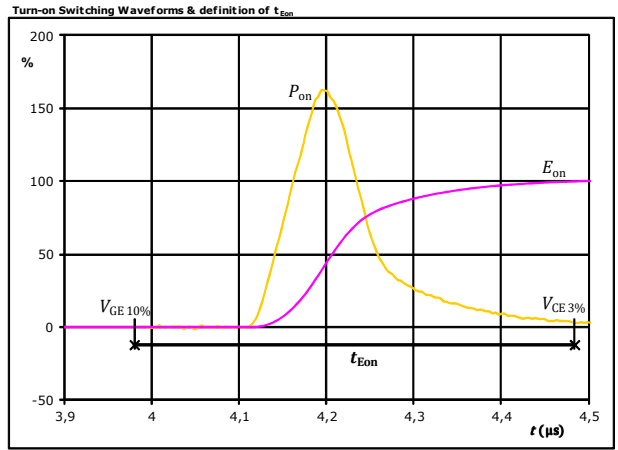

$P_{on}(100\%) = 15,13$ kW
 $E_{on}(100\%) = 2,66$ mJ
 $t_{Eon} = 0,50$ µs

figure 7. FWD

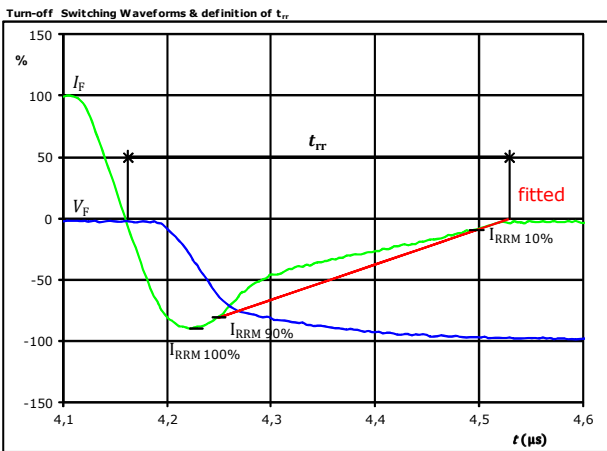

$V_F(100\%) = 600$ V
 $I_F(100\%) = 25$ A
 $I_{RRM}(100\%) = -23$ A
 $t_{rr} = 0,367$ µs



Vincotech

Inverter Switching Characteristics

figure 8. FWD

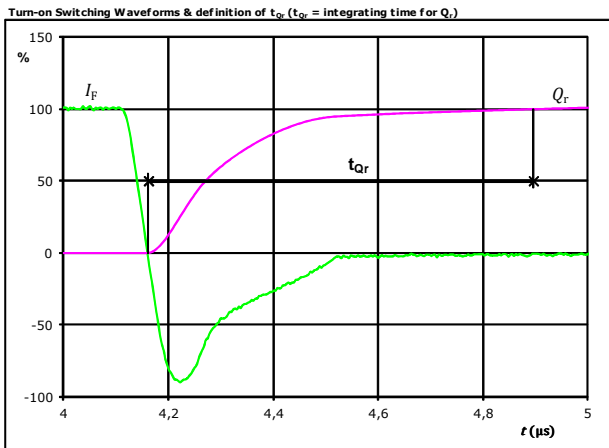

I_F (100%) =	25	A
Q_r (100%) =	3,88	μC
t_{Qr} =	0,73	μs

figure 9. FWD

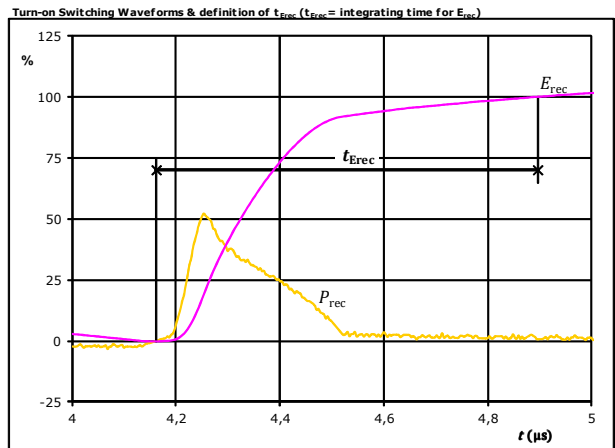

P_{rec} (100%) =	15,13	kW
E_{rec} (100%) =	1,45	mJ
t_{Erec} =	0,73	μs



Brake Switching Characteristics

figure 1. IGBT

Typical switching energy losses as a function of collector current

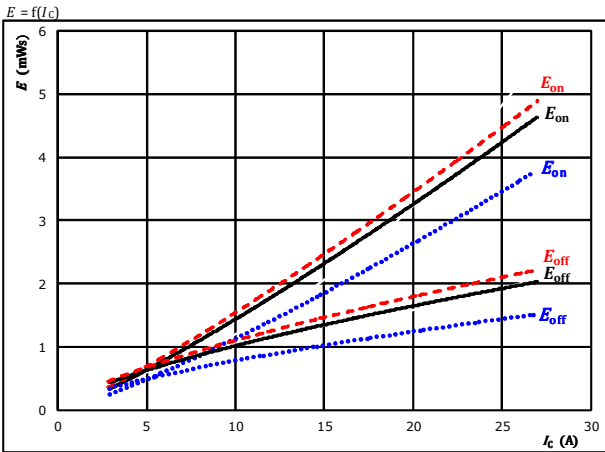

With an inductive load at
 $V_{CE} = 600$ V
 $V_{GE} = 15/0$ V
 $R_{gon} = 32$ Ω
 $R_{goff} = 32$ Ω

T_j : 25 °C (dotted blue), 125 °C (solid black), 150 °C (dashed red)

figure 2. IGBT

Typical switching energy losses as a function of gate resistor

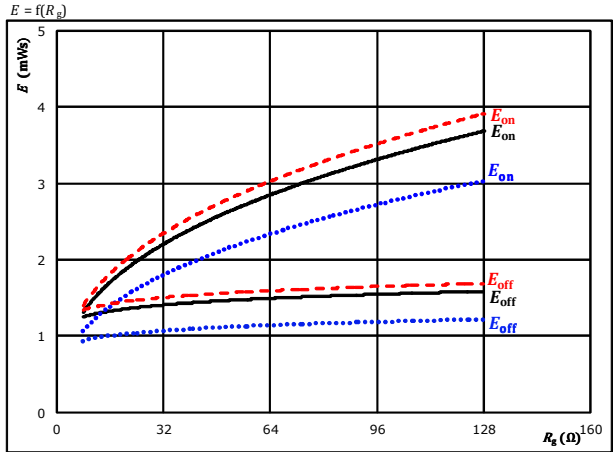

With an inductive load at
 $V_{CE} = 600$ V
 $V_{GE} = 15/0$ V
 $I_C = 15$ A

T_j : 25 °C (dotted blue), 125 °C (solid black), 150 °C (dashed red)

figure 3. FWD

Typical reverse recovered energy loss as a function of collector current

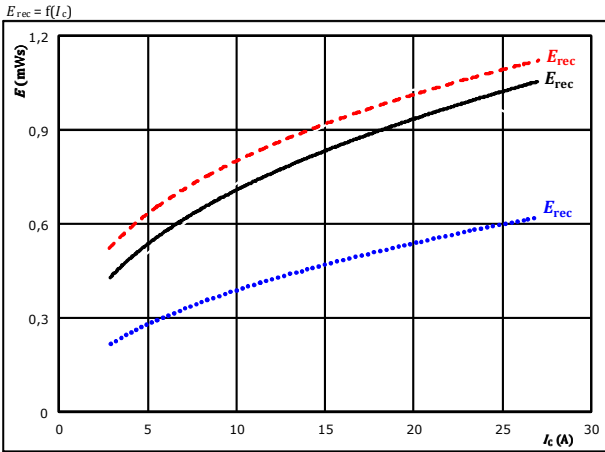

With an inductive load at
 $V_{CE} = 600$ V
 $V_{GE} = 15/0$ V
 $R_{gon} = 32$ Ω

T_j : 25 °C (dotted blue), 125 °C (solid black), 150 °C (dashed red)

figure 4. FWD

Typical reverse recovered energy loss as a function of gate resistor

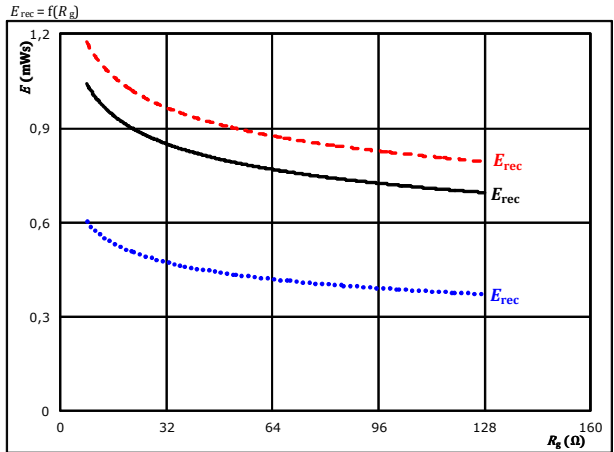

With an inductive load at
 $V_{CE} = 600$ V
 $V_{GE} = 15/0$ V
 $I_C = 15$ A

T_j : 25 °C (dotted blue), 125 °C (solid black), 150 °C (dashed red)



Brake Switching Characteristics

figure 5. IGBT

Typical switching times as a function of collector current

$$t = f(I_C)$$

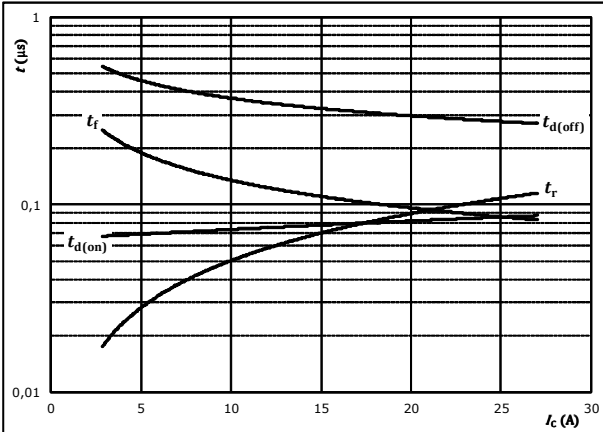

With an inductive load at

$T_j =$	150	°C
$V_{CE} =$	600	V
$V_{GE} =$	15/0	V
$R_{gon} =$	32	Ω
$R_{goff} =$	32	Ω

figure 6. IGBT

Typical switching times as a function of gate resistor

$$t = f(R_g)$$

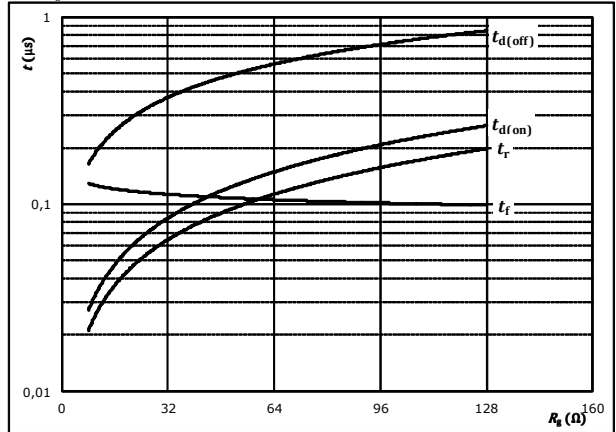

With an inductive load at

$T_j =$	150	°C
$V_{CE} =$	600	V
$V_{GE} =$	15/0	V
$I_C =$	15	A

figure 7. FWD

Typical reverse recovery time as a function of collector current

$$t_{rr} = f(I_C)$$

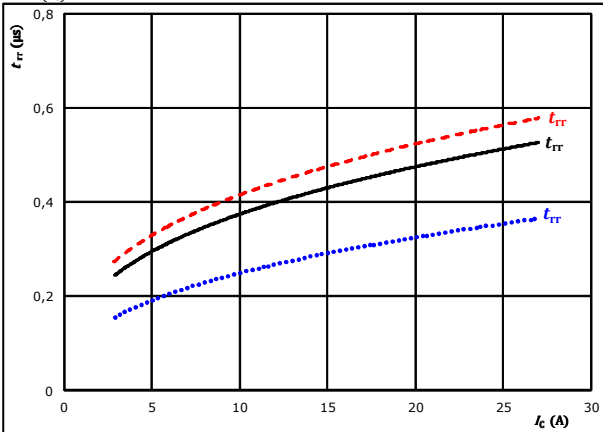

At	$V_{CE} =$	600	V	$T_j:$	25 °C
	$V_{GE} =$	15/0	V		125 °C	————
	$R_{gon} =$	32	Ω		150 °C	-----

figure 8. FWD

Typical reverse recovery time as a function of IGBT turn on gate resistor

$$t_{rr} = f(R_{gon})$$

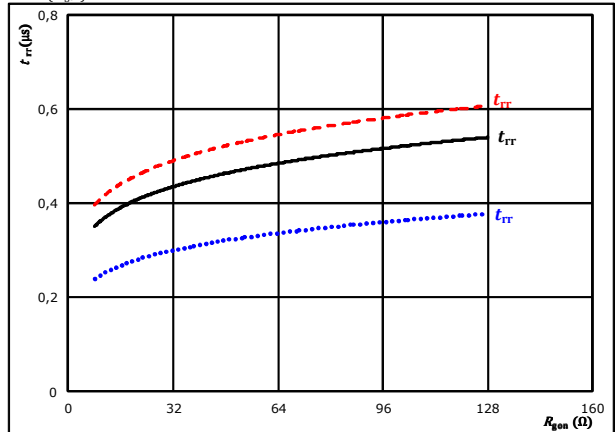

At	$V_{CE} =$	600	V	$T_j:$	25 °C
	$V_{GE} =$	15/0	V		125 °C	————
	$I_C =$	15	A		150 °C	-----



Brake Switching Characteristics

figure 9. FWD

Typical recovered charge as a function of collector current

$$Q_r = f(I_c)$$

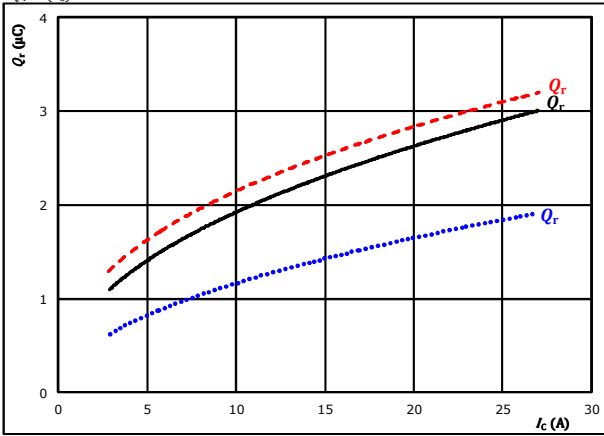

At $V_{CE} = 600$ V
 $V_{GE} = 15/0$ V
 $R_{gdn} = 32$ Ω
 $T_j: 25$ °C (dotted blue)
 125 °C (solid black)
 150 °C (dashed red)

figure 10. FWD

Typical recovered charge as a function of IGBT turn on gate resistor

$$Q_r = f(R_{gdn})$$

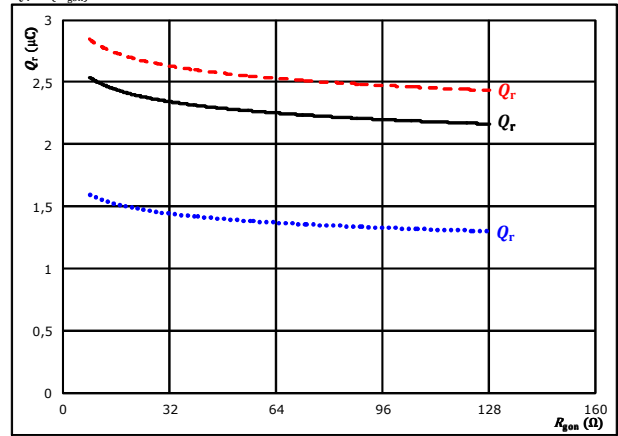

At $V_{CE} = 600$ V
 $V_{GE} = 15/0$ V
 $I_c = 15$ A
 $T_j: 25$ °C (dotted blue)
 125 °C (solid black)
 150 °C (dashed red)

figure 11. FWD

Typical peak reverse recovery current as a function of collector current

$$I_{RM} = f(I_c)$$

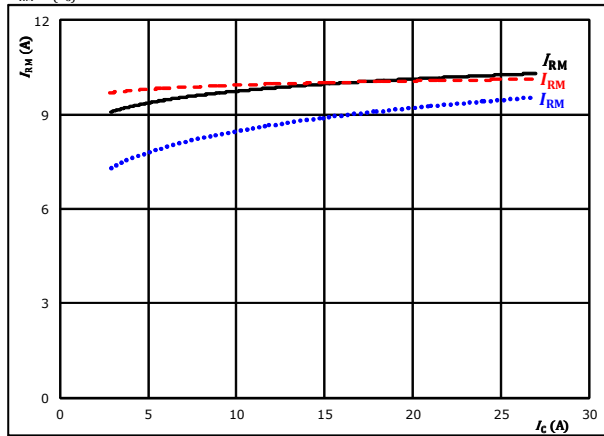

At $V_{CE} = 600$ V
 $V_{GE} = 15/0$ V
 $R_{gdn} = 32$ Ω
 $T_j: 25$ °C (dotted blue)
 125 °C (solid black)
 150 °C (dashed red)

figure 12. FWD

Typical peak reverse recovery current as a function of IGBT turn on gate resistor

$$I_{RM} = f(R_{gdn})$$

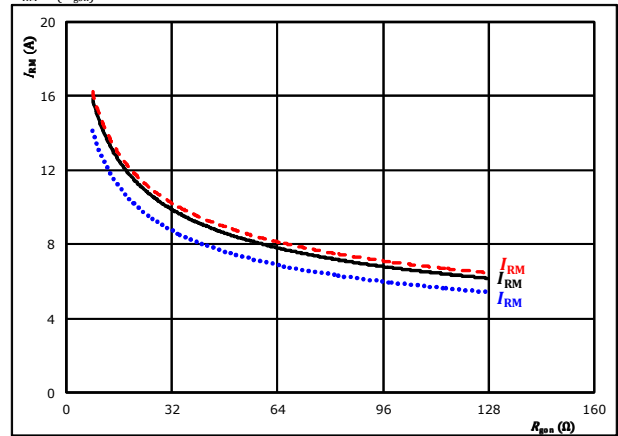

At $V_{CE} = 600$ V
 $V_{GE} = 15/0$ V
 $I_c = 15$ A
 $T_j: 25$ °C (dotted blue)
 125 °C (solid black)
 150 °C (dashed red)



Brake Switching Characteristics

figure 13. FWD

Typical rate of fall of forward and reverse recovery current as a function of collector current
 $di_f/dt, di_{rr}/dt = f(I_c)$

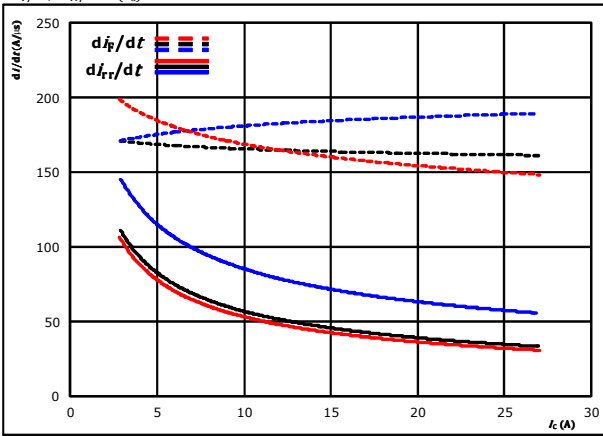

At $V_{CE} = 600$ V $T_j = 25$ °C
 $V_{GE} = 15/0$ V $T_j = 125$ °C ———
 $R_{g(on)} = 32$ Ω $T_j = 150$ °C - - - - -

figure 14. FWD

Typical rate of fall of forward and reverse recovery current as a function of IGBT turn on gate resistor
 $di_f/dt, di_{rr}/dt = f(R_{g(on)})$

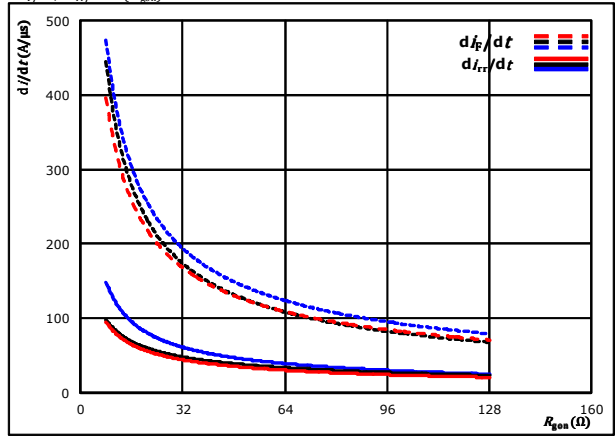

At $V_{CE} = 600$ V $T_j = 25$ °C
 $V_{GE} = 15/0$ V $T_j = 125$ °C ———
 $I_c = 15$ A $T_j = 150$ °C - - - - -

figure 15. IGBT

Reverse bias safe operating area
 $I_c = f(V_{CE})$

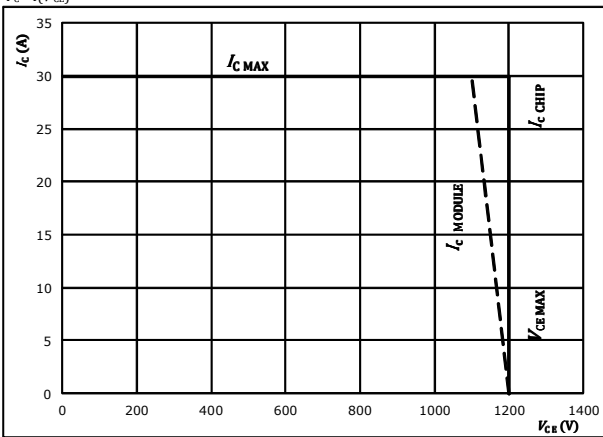

At $T_j = 175$ °C
 $R_{g(on)} = 32$ Ω
 $R_{g(off)} = 32$ Ω



Brake Switching Definitions

General conditions

T_j	=	125 °C
R_{gon}	=	32 Ω
R_{goff}	=	32 Ω

figure 1. IGBT

Turn-off Switching Waveforms & definition of t_{doff} , t_{Eoff} (t_{Eoff} = integrating time for E_{off})

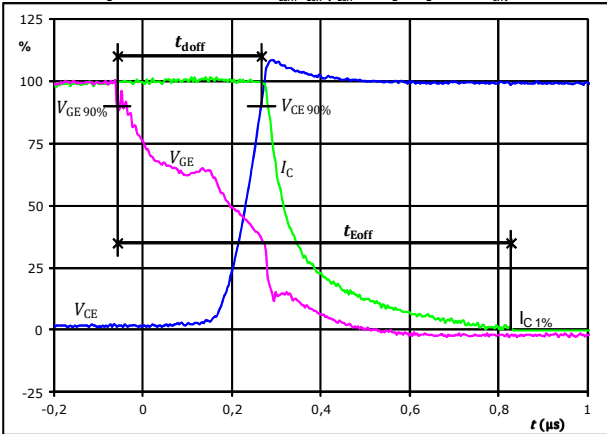

$V_{GE}(0\%) =$	0	V
$V_{GE}(100\%) =$	15	V
$V_C(100\%) =$	600	V
$I_C(100\%) =$	15	A
$t_{doff} =$	0,324	μs
$t_{Eoff} =$	0,885	μs

figure 2. IGBT

Turn-on Switching Waveforms & definition of t_{don} , t_{Eon} (t_{Eon} = integrating time for E_{on})

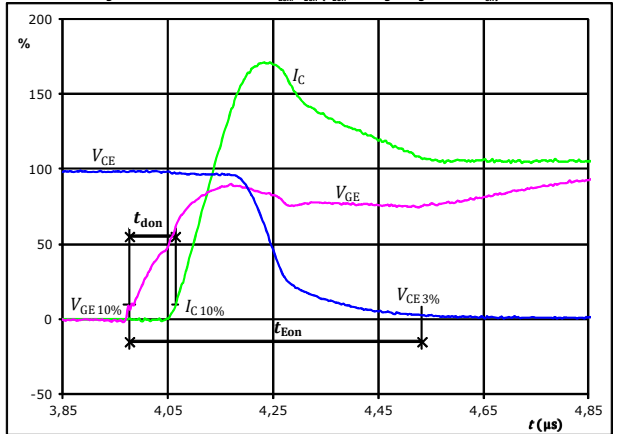

$V_{GE}(0\%) =$	0	V
$V_{GE}(100\%) =$	15	V
$V_C(100\%) =$	600	V
$I_C(100\%) =$	15	A
$t_{don} =$	0,085	μs
$t_{Eon} =$	0,556	μs

figure 3. IGBT

Turn-off Switching Waveforms & definition of t_f

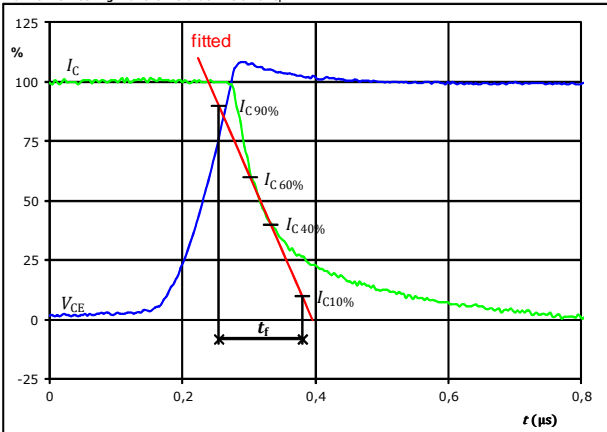

$V_C(100\%) =$	600	V
$I_C(100\%) =$	15	A
$t_f =$	0,116	μs

figure 4. IGBT

Turn-on Switching Waveforms & definition of t_r

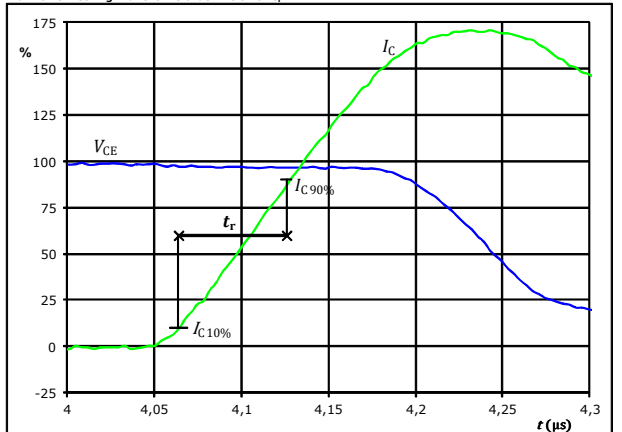

$V_C(100\%) =$	600	V
$I_C(100\%) =$	15	A
$t_r =$	0,062	μs



Vincotech

Brake Switching Characteristics

figure 5. IGBT

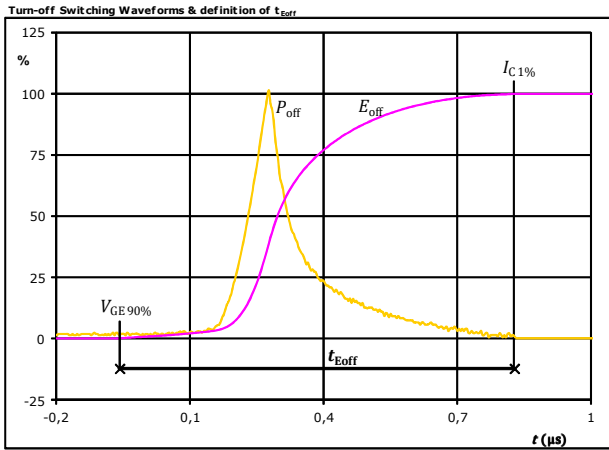

$P_{\text{off}}(100\%) = 8,99$ kW
 $E_{\text{off}}(100\%) = 1,34$ mJ
 $t_{\text{Eoff}} = 0,89$ μs

figure 6. IGBT

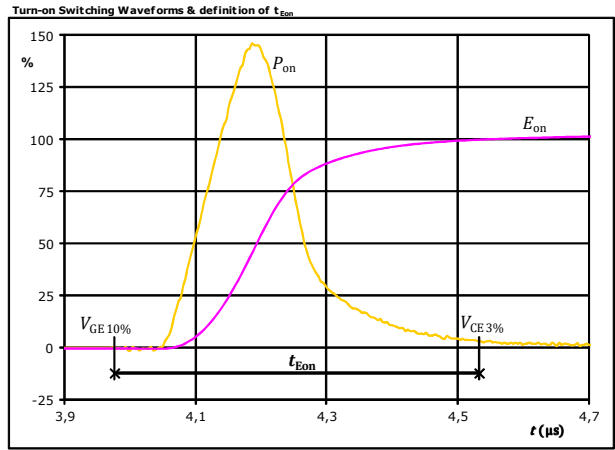

$P_{\text{on}}(100\%) = 8,99$ kW
 $E_{\text{on}}(100\%) = 2,05$ mJ
 $t_{\text{Eon}} = 0,56$ μs

figure 7. FWD

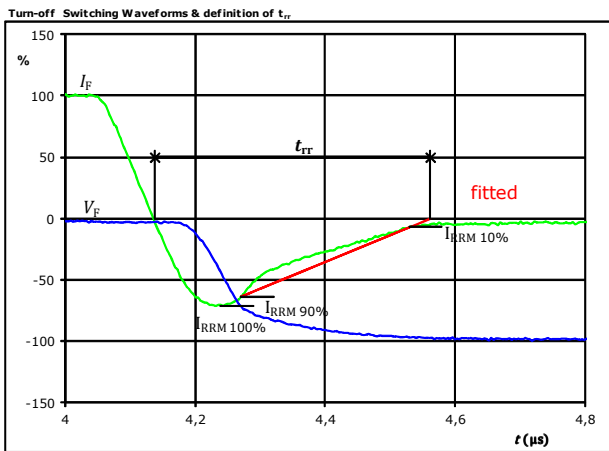

$V_{\text{F}}(100\%) = 600$ V
 $I_{\text{F}}(100\%) = 15$ A
 $I_{\text{RRM}}(100\%) = -11$ A
 $t_{\text{rr}} = 0,420$ μs



Brake Switching Characteristics

figure 8. FWD

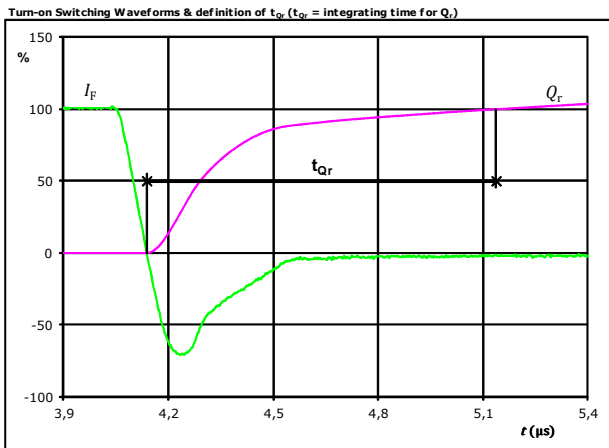

I_F (100%) =	15	A
Q_r (100%) =	2,44	μC
t_{Qr} =	1,00	μs

figure 9. FWD

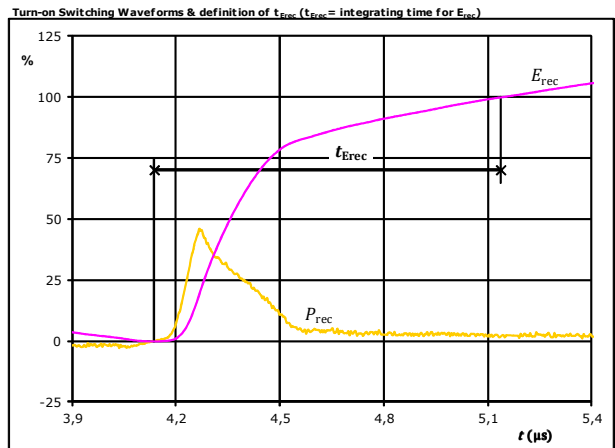

P_{rec} (100%) =	8,99	kW
E_{rec} (100%) =	0,92	mJ
t_{Erec} =	1,00	μs



Vincotech

Ordering Code & Marking								
Version			Ordering Code					
without thermal paste with solder pins			10-R112PMA025M7-P630A70					
with thermal paste with solder pins			10-R112PMA025M7-P630A70-/3/					
NN-NNNNNNNNNNNN TTTTWW WWYY UL VIN LLLLL SSSS			Name		Date code	UL & VIN	Lot	Serial
Text			NN-NNNNNNNNNNNN-TTTTWW		WWYY	UL VIN	LLLLL	SSSS
Datamatrix		Type&Ver	Lot number	Serial	Date code			
		TTTTWW	LLLLL	SSSS	WWYY			

Pin table				Outline	
Pin	X	Y	Function	<p>Technical drawing showing top and bottom views of the component. The top view shows 22 pins numbered 1 to 22. Dimensions include a width of 26.5 mm and a height of 13 mm. The bottom view shows a width of 17.36 ± 0.5 mm and a diameter of 1 ± 0.05 mm for the pins.</p>	
1	53	0	ACIn2		
2	46	0	Br		
3	39,5	0	DC-Rect		
4	32,5	0	DC+Rect		
5	28,1	0	DC+Inv		
6	18	0	G15		
7	15	0	DC-3		
8	12	0	G13		
9	9	0	DC-2		
10	3	0	G11		
11	0	0	DC-1		
12	0	7	G12		
13	3	7	Ph1		
14	8,5	7	G14		
15	11,5	7	Ph2		
16	17	7	G16		
17	20	7	Ph3		
18	33	7	Therm1		
19	36	7	DC-Br		
20	39	7	G27		
21	46	7	ACIn1		
22	53	7	ACIn3		

Tolerance of pinpositions: ±0.5mm at the end of pins
Dimension of coordinate axis is only offset without tolerance



Vincotech

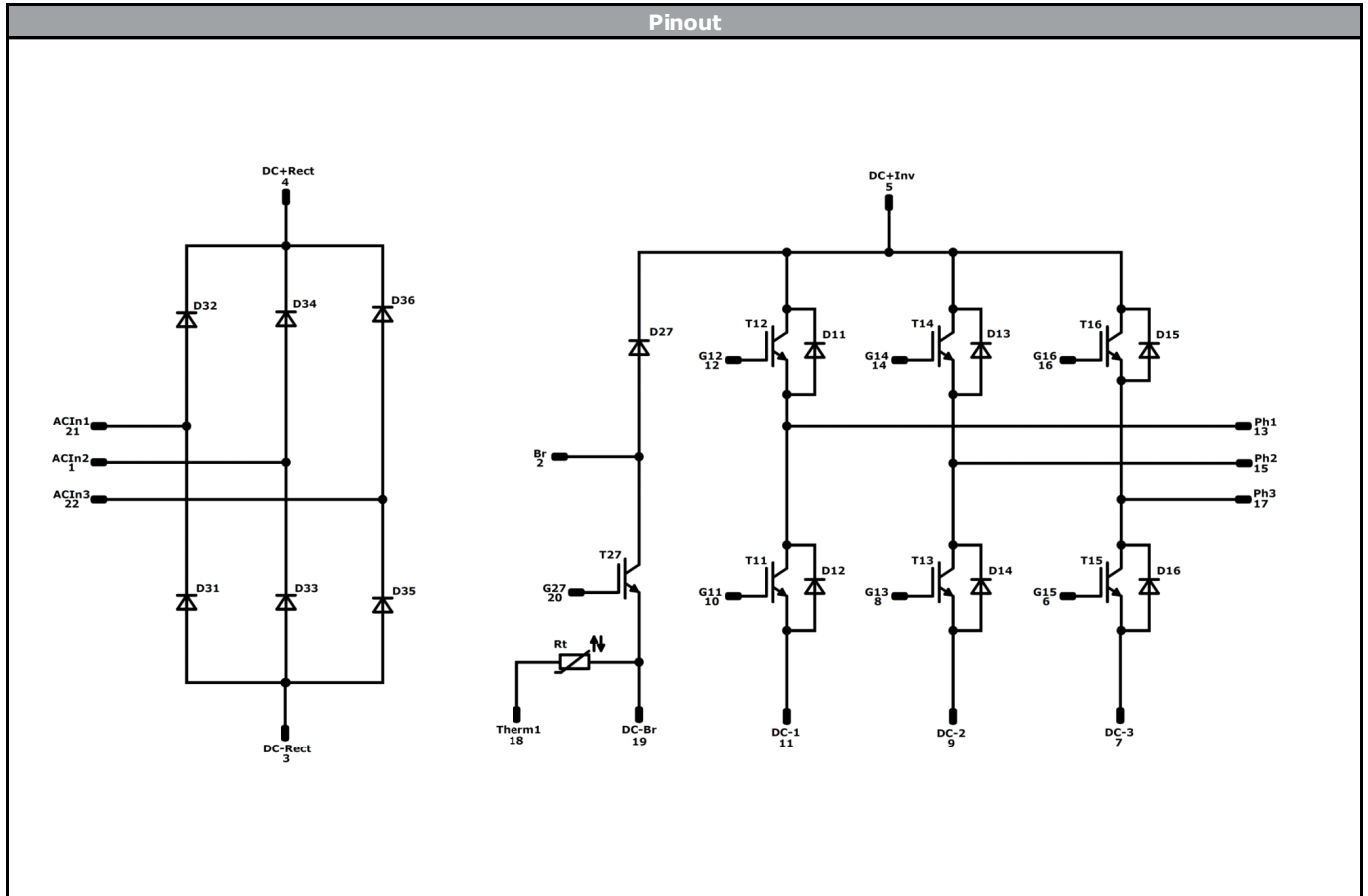

Identification					
ID	Component	Voltage	Current	Function	Comment
D31, D32, D33, D34, D35, D36	Rectifier	1600 V	25 A	Rectifier	
T11, T12, T13, T14, T15, T16	IGBT	1200 V	25 A	Inverter Switch	
D11, D12, D13, D14, D15, D16	FWD	1200 V	25 A	Inverter Diode	
T27	IGBT	1200 V	15 A	Brake Switch	
D27	FWD	1200 V	15 A	Brake Diode	
Rt	NTC			Thermistor	



Vincotech

Packaging instruction			
Standard packaging quantity (SPQ) 80	>SPQ	Standard	<SPQ Sample

Handling instruction
Handling instructions for <i>flow</i> 90 1 packages see vincotech.com website.

Package data
Package data for <i>flow</i> 90 1 packages see vincotech.com website.

UL recognition and file number
This device is certified according to UL 1557 standard, UL file number E192116. For more information see vincotech.com website. 

Document No.:	Date:	Modification:	Pages
10-R112PMA025M7-P630A70-D2-14	18 Feb. 2019	Added thermal paste option to ordering code	30

DISCLAIMER

The information, specifications, procedures, methods and recommendations herein (together "information") are presented by Vincotech to reader in good faith, are believed to be accurate and reliable, but may well be incomplete and/or not applicable to all conditions or situations that may exist or occur. Vincotech reserves the right to make any changes without further notice to any products to improve reliability, function or design. No representation, guarantee or warranty is made to reader as to the accuracy, reliability or completeness of said information or that the application or use of any of the same will avoid hazards, accidents, losses, damages or injury of any kind to persons or property or that the same will not infringe third parties rights or give desired results. It is reader's sole responsibility to test and determine the suitability of the information and the product for reader's intended use.

LIFE SUPPORT POLICY

Vincotech products are not authorised for use as critical components in life support devices or systems without the express written approval of Vincotech.

As used herein:

1. Life support devices or systems are devices or systems which, (a) are intended for surgical implant into the body, or (b) support or sustain life, or (c) whose failure to perform when properly used in accordance with instructions for use provided in labelling can be reasonably expected to result in significant injury to the user.
2. A critical component is any component of a life support device or system whose failure to perform can be reasonably expected to cause the failure of the life support device or system, or to affect its safety or effectiveness.