



flowNPC 0 IGBT

600 V / 75 A

Topology features

- Kelvin Emitter for improved switching performance
- Neutral Point Clamped Topology (I-Type)
- Temperature sensor

Component features

- Easy paralleling
- Low turn-off losses
- Low collector emitter saturation voltage
- Positive temperature coefficient
- Short tail current

Housing features

- Base isolation: Al₂O₃
- Clip-in, reliable mechanical connection, qualified for wave soldering
- Convex shaped substrate for superior thermal contact
- Thermo-mechanical push-and-pull force relief
- Press-fit pin
- Reliable cold welding connection

Target applications

- UPS
- Solar

Types

- 10-PZ06NIA075SA-P926F33Y

flow 0 12 mm housing

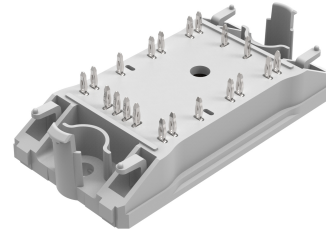

Schematic

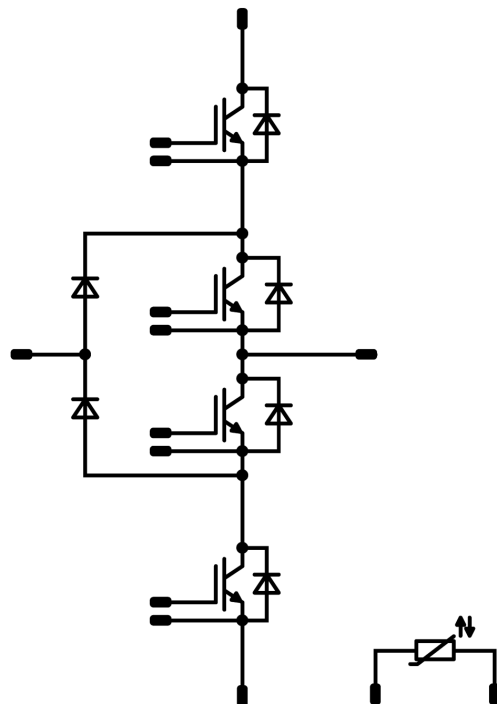



Vincotech

10-PZ06NIA075SA-P926F33Y
datasheet

Maximum Ratings

$T_j = 25\text{ °C}$, unless otherwise specified

Parameter	Symbol	Conditions	Value	Unit
Buck Switch				
Collector-emitter voltage	V_{CES}		600	V
Collector current (DC current)	I_C	$T_j = T_{jmax}$ $T_s = 80\text{ °C}$	64	A
Repetitive peak collector current	I_{CRM}	t_p limited by T_{jmax}	225	A
Total power dissipation	P_{tot}	$T_j = T_{jmax}$ $T_s = 80\text{ °C}$	112	W
Gate-emitter voltage	V_{GES}		± 20	V
Short circuit ratings	t_{SC}	$V_{GE} = 15\text{ V}$, $V_{CC} = 360\text{ V}$ $T_j = 150\text{ °C}$	6	μs
Maximum junction temperature	T_{jmax}		175	$^{\circ}\text{C}$

Buck Diode

Peak repetitive reverse voltage	V_{RRM}		600	V
Forward current (DC current)	I_F	$T_j = T_{jmax}$ $T_s = 80\text{ °C}$	66	A
Repetitive peak forward current	I_{FRM}	t_p limited by T_{jmax}	150	A
Total power dissipation	P_{tot}	$T_j = T_{jmax}$ $T_s = 80\text{ °C}$	87	W
Maximum junction temperature	T_{jmax}		175	$^{\circ}\text{C}$

Boost Switch

Collector-emitter voltage	V_{CES}		600	V
Collector current (DC current)	I_C	$T_j = T_{jmax}$ $T_s = 80\text{ °C}$	64	A
Repetitive peak collector current	I_{CRM}	t_p limited by T_{jmax}	225	A
Total power dissipation	P_{tot}	$T_j = T_{jmax}$ $T_s = 80\text{ °C}$	112	W
Gate-emitter voltage	V_{GES}		± 20	V
Short circuit ratings	t_{SC}	$V_{GE} = 15\text{ V}$, $V_{CC} = 360\text{ V}$ $T_j = 150\text{ °C}$	6	μs
Maximum junction temperature	T_{jmax}		175	$^{\circ}\text{C}$

**Maximum Ratings** $T_j = 25\text{ °C}$, unless otherwise specified

Parameter	Symbol	Conditions	Value	Unit
Boost Diode				
Peak repetitive reverse voltage	V_{RRM}		600	V
Forward current (DC current)	I_F	$T_j = T_{jmax}$ $T_s = 80\text{ °C}$	66	A
Repetitive peak forward current	I_{FRM}	t_p limited by T_{jmax}	150	A
Total power dissipation	P_{tot}	$T_j = T_{jmax}$ $T_s = 80\text{ °C}$	87	W
Maximum junction temperature	T_{jmax}		175	°C

Boost Sw. Inv. Diode

Peak repetitive reverse voltage	V_{RRM}		600	V
Forward current (DC current)	I_F	$T_j = T_{jmax}$ $T_s = 80\text{ °C}$	66	A
Repetitive peak forward current	I_{FRM}	t_p limited by T_{jmax}	150	A
Total power dissipation	P_{tot}	$T_j = T_{jmax}$ $T_s = 80\text{ °C}$	87	W
Maximum junction temperature	T_{jmax}		175	°C

Module Properties**Thermal Properties**

Storage temperature	T_{stg}		-40...+125	°C
Operation temperature under switching condition	T_{jop}		-40...+($T_{jmax} - 25$)	°C

Isolation Properties

Isolation voltage	V_{isol}	DC Test Voltage* $t_p = 2\text{ s}$	6000	V
Isolation voltage	V_{isol}	AC Voltage $t_p = 1\text{ min}$	2500	V
Creepage distance			>12,7	mm
Clearance			9	mm
Comparative Tracking Index	CTI		≥ 200	

*100 % tested in production



Vincotech

10-PZ06NIA075SA-P926F33Y
datasheet

Characteristic Values

Parameter	Symbol	Conditions					Values			Unit
		V_{GE} [V] V_{GS} [V]	V_{CE} [V] V_{DS} [V] V_F [V]	I_C [A] I_D [A] I_F [A]	T_j [°C]	Min	Typ	Max		

Buck Switch

Static

Gate-emitter threshold voltage	$V_{GE(th)}$	$V_{CE} = V_{GE}$			0,0012	25	5	5,8	6,5	V
Collector-emitter saturation voltage	$V_{CE(sat)}$		15		75	25 125 150	1,05	1,58 1,78 1,82	1,85 ⁽¹⁾	V
Collector-emitter cut-off current	I_{CES}		0	600		25			3,8	μA
Gate-emitter leakage current	I_{GES}		20	0		25			600	nA
Internal gate resistance	r_g							None		Ω
Input capacitance	C_{ies}							4620		pF
Output capacitance	C_{oes}	$f = 1$ Mhz	0	25		25		288		pF
Reverse transfer capacitance	C_{res}							137		pF
Gate charge	Q_g	$V_{CC} = 480$ V	15		75	25		470		nC

Thermal

Thermal resistance junction to sink ⁽²⁾	$R_{th(j-s)}$	$\lambda_{paste} = 3,4$ W/mK (PSX)						0,85		K/W
--	---------------	---------------------------------------	--	--	--	--	--	------	--	-----

Dynamic

Turn-on delay time	$t_{d(on)}$	$R_{gon} = 8$ Ω $R_{goff} = 8$ Ω	±15	350	75	25		144,2		ns
						125		145		
Rise time	t_r					25		17		
						125		21,2		
Turn-off delay time	$t_{d(off)}$					25		207,2		
						125		228,4		
Fall time	t_f					25		103,96		ns
						125		123,58		
Turn-on energy (per pulse)	E_{on}	$Q_{tFWD} = 3,22$ μC				25		1,48		mWs
		$Q_{tFWD} = 6,01$ μC				125		1,88		
Turn-off energy (per pulse)	E_{off}					25		2,04		mWs
						125		2,58		



Vincotech

Characteristic Values

Parameter	Symbol	Conditions						Values			Unit
		V_{GS} [V]	V_{GE} [V]	V_{DS} [V]	V_{CE} [V]	I_D [A]	I_C [A]	T_j [°C]	Min	Typ	

Buck Diode

Static

Forward voltage	V_F					75	25 125 150	1,2	1,46 1,42 1,4	1,9 ⁽¹⁾	V
Reverse leakage current	I_R	$V_r = 600$ V					25			27	μA

Thermal

Thermal resistance junction to sink ⁽²⁾	$R_{th(j-s)}$	$\lambda_{paste} = 3,4$ W/mK (PSX)							1,09		K/W
--	---------------	------------------------------------	--	--	--	--	--	--	------	--	-----

Dynamic

Peak recovery current	I_{RM}	$di/dt=4853$ A/μs $di/dt=3998$ A/μs	±15	350	75	25		69,66		A
Reverse recovery time	t_{rr}					125		80,94		
						25		133,67		
Recovered charge	Q_r					125		264,69		
						25		3,22		
Reverse recovered energy	E_{rec}					125		6,01		
		25		0,639						
Peak rate of fall of recovery current	$(di_{rr}/dt)_{max}$	125		1,32						
		25		5313						
						125		3017		A/μs



Vincotech

10-PZ06NIA075SA-P926F33Y
datasheet

Characteristic Values

Parameter	Symbol	Conditions					Values			Unit
		V_{GS} [V]	V_{GE} [V]	V_{DS} [V]	V_F [V]	I_C [A] I_D [A] I_F [A]	T_j [°C]	Min	Typ	

Boost Switch

Static

Gate-emitter threshold voltage	$V_{GE(th)}$	$V_{CE} = V_{GE}$				0,0012	25	5	5,8	6,5	V
Collector-emitter saturation voltage	$V_{CE(sat)}$		15		75		25 125 150	1,05	1,58 1,78 1,82	1,85 ⁽¹⁾	V
Collector-emitter cut-off current	I_{CES}		0	600			25			3,8	µA
Gate-emitter leakage current	I_{GES}		20	0			25			600	nA
Internal gate resistance	r_g								None		Ω
Input capacitance	C_{ies}								4620		pF
Output capacitance	C_{oes}	$f = 1$ Mhz	0	25			25		288		pF
Reverse transfer capacitance	C_{res}								137		pF
Gate charge	Q_g	$V_{CC} = 480$ V	15		75		25		470		nC

Thermal

Thermal resistance junction to sink ⁽²⁾	$R_{th(j-s)}$	$\lambda_{paste} = 3,4$ W/mK (PSX)							0,85		K/W
--	---------------	---------------------------------------	--	--	--	--	--	--	------	--	-----

Dynamic

Turn-on delay time	$t_{d(on)}$						25 125		141,8 143,2		ns
Rise time	t_r	$R_{gon} = 8$ Ω $R_{goff} = 8$ Ω					25 125		21 23,6		ns
Turn-off delay time	$t_{d(off)}$		±15	350	75		25 125		206,4 227,4		ns
Fall time	t_f						25 125		89,63 111,69		ns
Turn-on energy (per pulse)	E_{on}	$Q_{tFWD} = 3,5$ µC $Q_{tFWD} = 5,76$ µC					25 125		1,3 1,68		mWs
Turn-off energy (per pulse)	E_{off}						25 125		2,15 2,75		mWs



Vincotech

Characteristic Values

Parameter	Symbol	Conditions					Values			Unit
		V_{GE} [V] V_{GS} [V]	V_{CE} [V] V_{DS} [V] V_F [V]	I_C [A] I_D [A] I_F [A]	T_j [°C]	Min	Typ	Max		
Boost Diode										
Static										
Forward voltage	V_F				75	25 125 150	1,2	1,46 1,42 1,4	1,9 ⁽¹⁾	V
Reverse leakage current	I_R	$V_r = 600$ V				25			27	μA
Thermal										
Thermal resistance junction to sink ⁽²⁾	$R_{th(j-s)}$	$\lambda_{paste} = 3,4$ W/mK (PSX)						1,09		K/W
Dynamic										
Peak recovery current	I_{RM}	$di/dt=4515$ A/μs $di/dt=4247$ A/μs	±15	350	75	25 125		60,12 69,02		A
Reverse recovery time	t_{rr}					25 125		133,97 167,81		ns
Recovered charge	Q_r					25 125		3,5 5,76		μC
Reverse recovered energy	E_{rec}					25 125		0,851 1,42		mWs
Peak rate of fall of recovery current	$(di_{rr}/dt)_{max}$					25 125		2711 341,4		A/μs



Vincotech

Characteristic Values

Parameter	Symbol	Conditions					Values			Unit
		V_{GE} [V] V_{GS} [V]	V_{CE} [V] V_{DS} [V] V_F [V]	I_C [A] I_D [A] I_F [A]	T_j [°C]	Min	Typ	Max		

Boost Sw. Inv. Diode

Static

Forward voltage	V_F				75	25 125 150	1,2	1,46 1,42 1,4	1,9 ⁽¹⁾	V
Reverse leakage current	I_R	$V_T = 600$ V				25			27	μA

Thermal

Thermal resistance junction to sink ⁽²⁾	$R_{th(j-s)}$	$\lambda_{paste} = 3,4$ W/mK (PSX)						1,09		K/W
--	---------------	---------------------------------------	--	--	--	--	--	------	--	-----

Thermistor

Static

Rated resistance	R					25		22		kΩ
Deviation of R_{100}	$\Delta_{R/R}$	$R_{100} = 1484$ Ω				100	-5		5	%
Power dissipation	P					25		130		mW
Power dissipation constant	d					25		1,5		mW/K
B-value	$B_{(25/50)}$	Tol. ± 1 %						3962		K
B-value	$B_{(25/100)}$	Tol. ± 1 %						4000		K
Vincotech Thermistor Reference									I	

⁽¹⁾ Value at chip level

⁽²⁾ Only valid with pre-applied Vincotech thermal interface material.



Buck Switch Characteristics

figure 1. IGBT

Typical output characteristics

$$I_C = f(V_{CE})$$

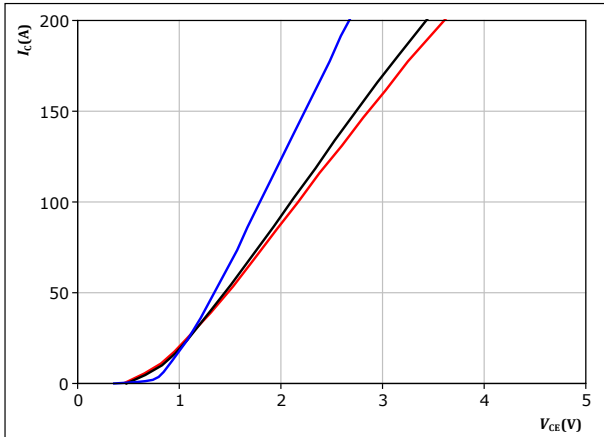

$t_p = 250 \mu s$
 $V_{GE} = 15 V$

T_j :
— 25 °C
— 125 °C
— 150 °C

figure 2. IGBT

Typical output characteristics

$$I_C = f(V_{CE})$$

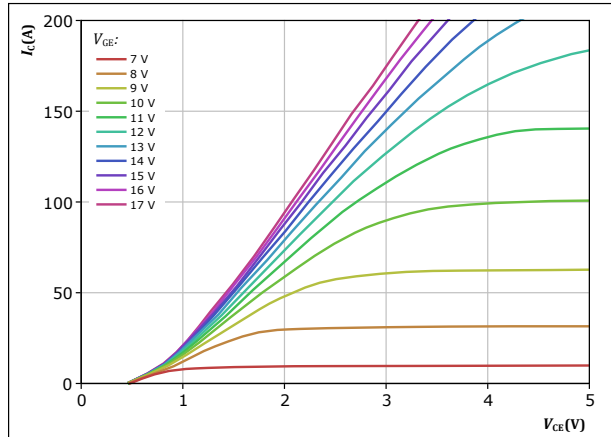

$t_p = 250 \mu s$
 $T_j = 150 \text{ °C}$
 V_{GE} from 7 V to 17 V in steps of 1 V

figure 3. IGBT

Typical transfer characteristics

$$I_C = f(V_{GE})$$

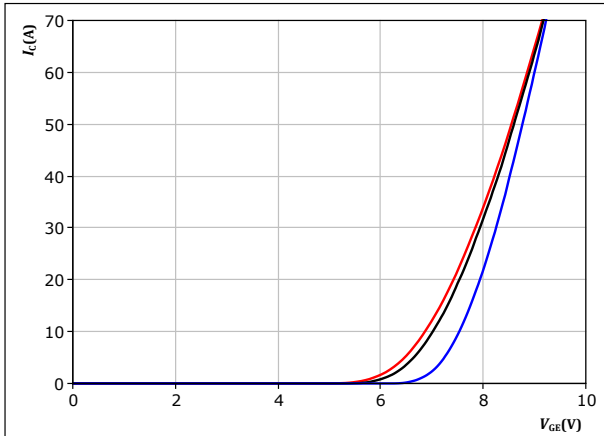

$t_p = 250 \mu s$
 $V_{CE} = 10 V$

T_j :
— 25 °C
— 125 °C
— 150 °C

figure 4. IGBT

Transient thermal impedance as a function of pulse width

$$Z_{th(j-s)} = f(t_p)$$

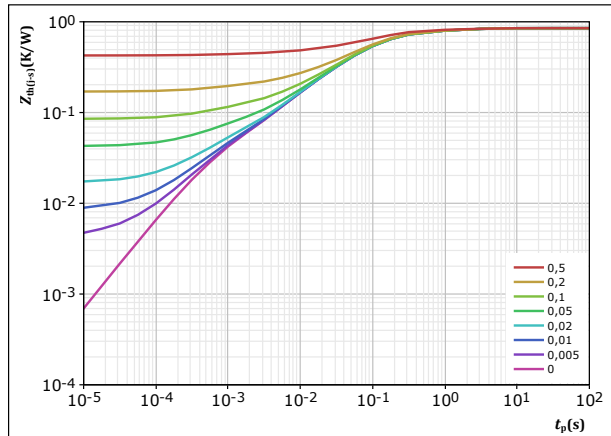

$D = t_p / T$
 $R_{th(j-s)} = 0,851 \text{ K/W}$

IGBT thermal model values

R (K/W)	τ (s)
$6,06E-02$	$2,36E+00$
$1,16E-01$	$4,40E-01$
$4,51E-01$	$9,55E-02$
$1,42E-01$	$2,48E-02$
$5,26E-02$	$5,75E-03$
$2,79E-02$	$5,60E-04$



Buck Switch Characteristics

figure 5. IGBT

Safe operating area

$$I_C = f(V_{CE})$$

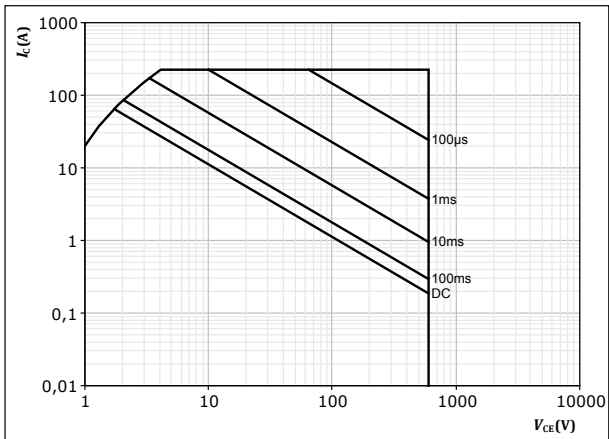

$D =$ single pulse
 $T_s = 80 \text{ } ^\circ\text{C}$
 $V_{GE} = 15 \text{ V}$
 $T_j = T_{jmax}$



Buck Diode Characteristics

figure 6. FWD

Typical forward characteristics

$$I_F = f(V_F)$$

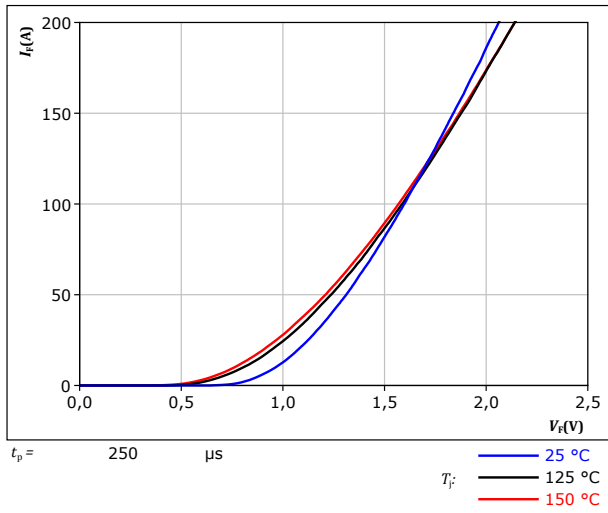
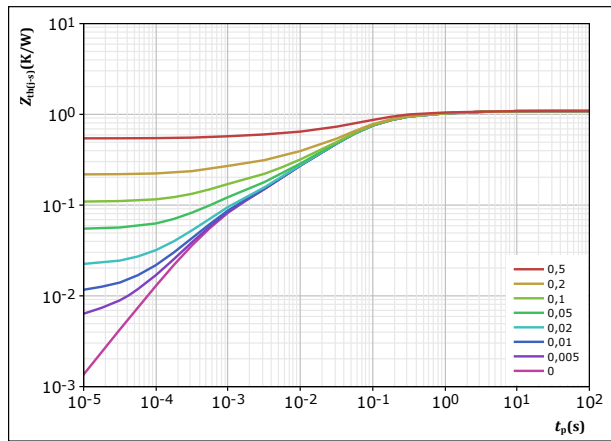

figure 7. FWD

Transient thermal impedance as a function of pulse width

$$Z_{th(j-s)} = f(t_p)$$



$D =$	t_p / T	
$R_{th(j-s)} =$	1,088	K/W
FWD thermal model values		
R (K/W)	τ (s)	
7,90E-02	2,56E+00	
1,75E-01	3,30E-01	
6,03E-01	6,52E-02	
1,61E-01	8,53E-03	
7,01E-02	6,48E-04	



Boost Switch Characteristics

figure 8. IGBT

Typical output characteristics
 $I_C = f(V_{CE})$

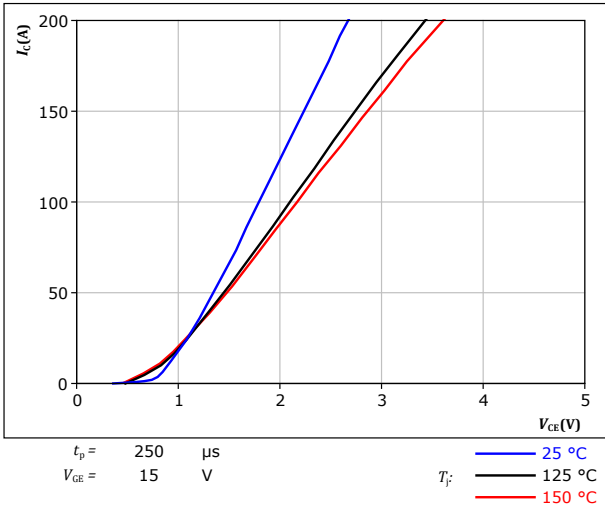

figure 9. IGBT

Typical output characteristics
 $I_C = f(V_{CE})$

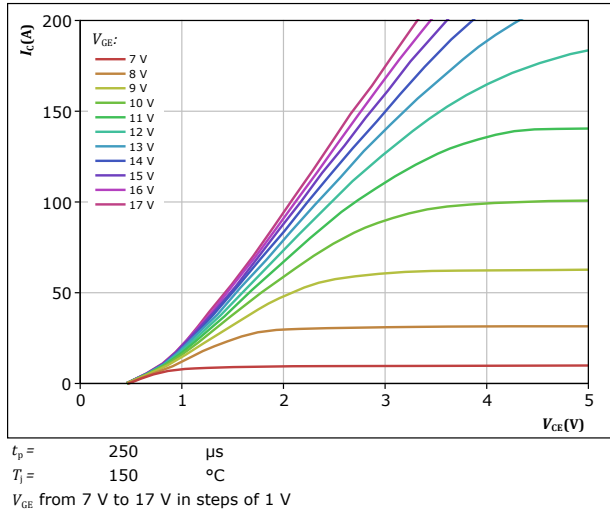

figure 10. IGBT

Typical transfer characteristics
 $I_C = f(V_{GE})$

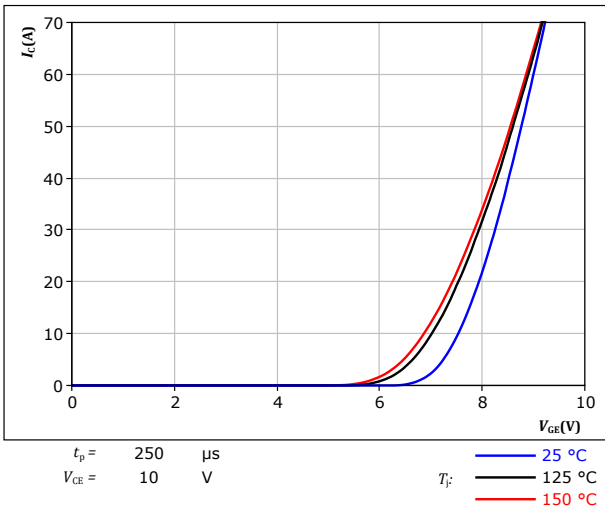
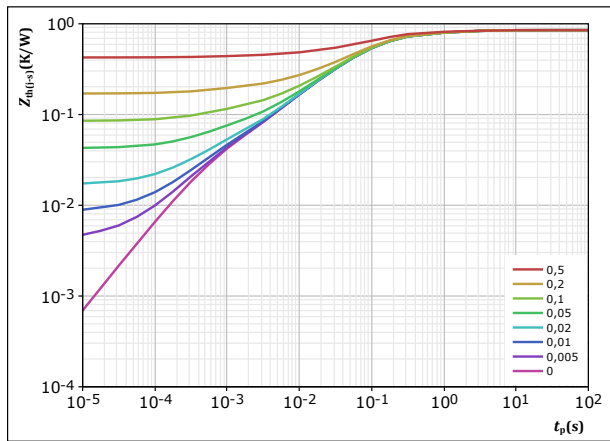

figure 11. IGBT

Transient thermal impedance as a function of pulse width
 $Z_{th(j-s)} = f(t_p)$



$D = t_p / T$
 $R_{th(j-s)} = 0,851 \text{ K/W}$

IGBT thermal model values

R (K/W)	τ (s)
6,06E-02	2,36E+00
1,16E-01	4,40E-01
4,51E-01	9,55E-02
1,42E-01	2,48E-02
5,26E-02	5,75E-03
2,79E-02	5,60E-04



Boost Switch Characteristics

figure 12. IGBT

Safe operating area

$$I_C = f(V_{CE})$$

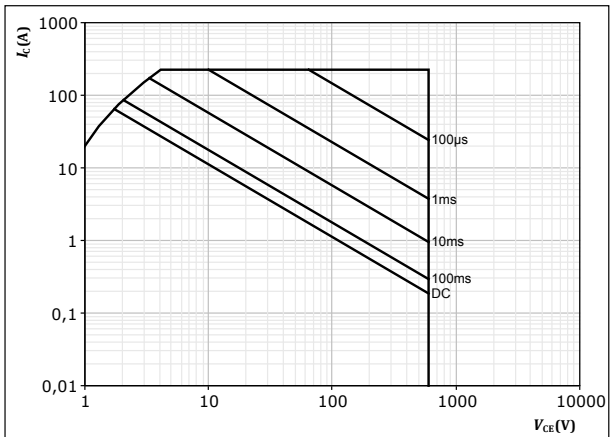

$D =$ single pulse
 $T_s = 80 \text{ } ^\circ\text{C}$
 $V_{GE} = 15 \text{ V}$
 $T_j = T_{jmax}$



Boost Diode Characteristics

figure 13. FWD

Typical forward characteristics

$$I_F = f(V_F)$$

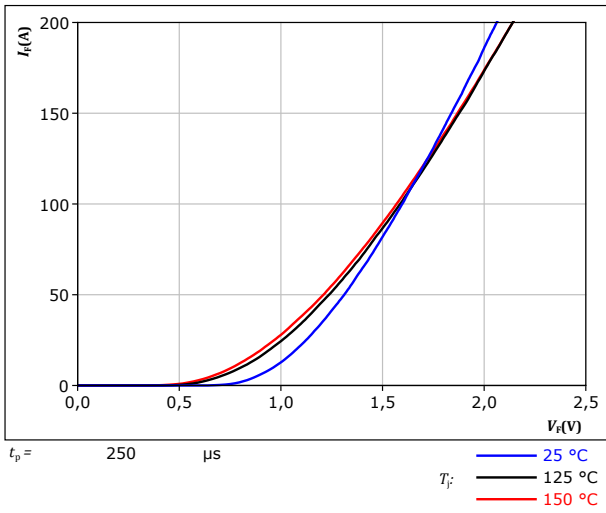
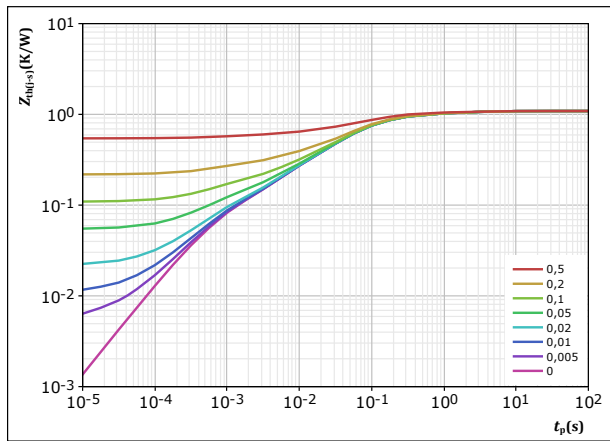

figure 14. FWD

Transient thermal impedance as a function of pulse width

$$Z_{th(j-s)} = f(t_p)$$



$D =$	t_p / T	
$R_{th(j-s)} =$	1,088	K/W
FWD thermal model values		
R (K/W)	τ (s)	
7,90E-02	2,56E+00	
1,75E-01	3,30E-01	
6,03E-01	6,52E-02	
1,61E-01	8,53E-03	
7,01E-02	6,48E-04	



Boost Sw. Inv. Diode Characteristics

figure 15. FWD

Typical forward characteristics

$$I_F = f(V_F)$$

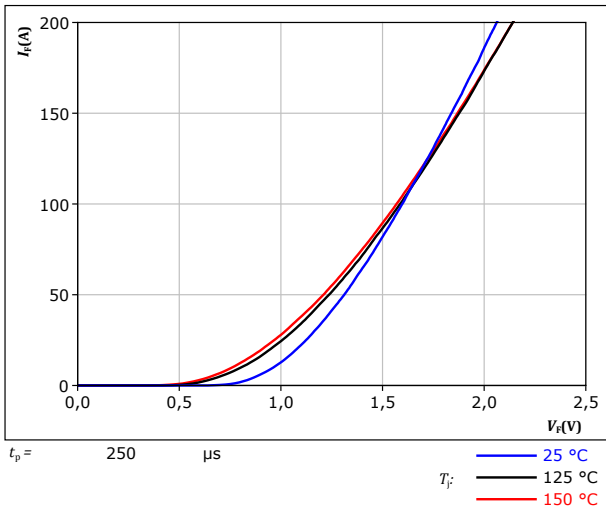
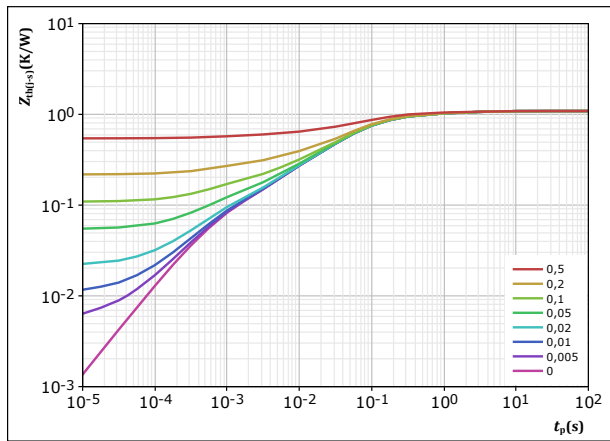

figure 16. FWD

Transient thermal impedance as a function of pulse width

$$Z_{th(j-s)} = f(t_p)$$



$D =$	t_p / T	
$R_{th(j-s)} =$	1,088	K/W
FWD thermal model values		
R (K/W)	τ (s)	
7,90E-02	2,56E+00	
1,75E-01	3,30E-01	
6,03E-01	6,52E-02	
1,61E-01	8,53E-03	
7,01E-02	6,48E-04	



Thermistor Characteristics

figure 17. Thermistor

Typical NTC characteristic as function of temperature

$$R_T = f(T)$$

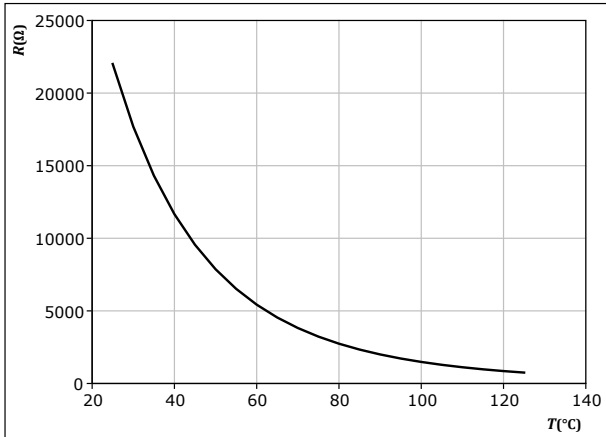



Buck Switching Characteristics

figure 18. IGBT

Typical switching energy losses as a function of collector current
 $E = f(I_c)$

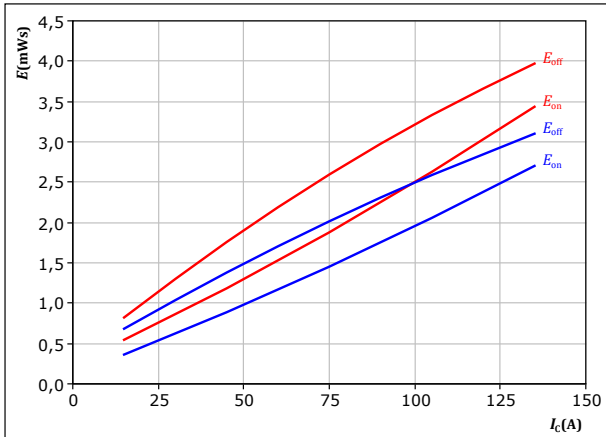

With an inductive load at

$V_{CE} = 350$ V
 $V_{GE} = \pm 15$ V
 $R_{gon} = 8$ Ω
 $R_{goff} = 8$ Ω

T_j : — 25 °C
 — 125 °C

figure 19. IGBT

Typical switching energy losses as a function of IGBT turn on gate resistor
 $E = f(R_g)$

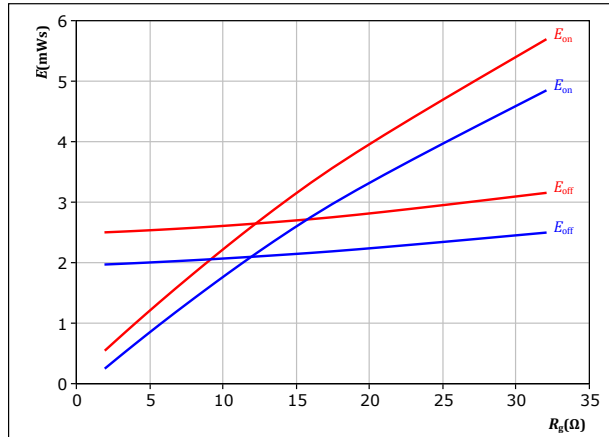

With an inductive load at

$V_{CE} = 350$ V
 $V_{GE} = \pm 15$ V
 $I_c = 75$ A

T_j : — 25 °C
 — 125 °C

figure 20. FWD

Typical reverse recovered energy loss as a function of collector current
 $E_{rec} = f(I_c)$

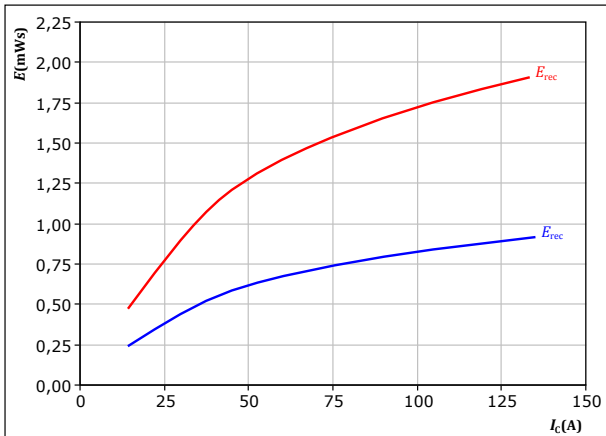

With an inductive load at

$V_{CE} = 350$ V
 $V_{GE} = \pm 15$ V
 $R_{gon} = 8$ Ω

T_j : — 25 °C
 — 125 °C

figure 21. FWD

Typical reverse recovered energy loss as a function of IGBT turn on gate resistor
 $E_{rec} = f(R_g)$

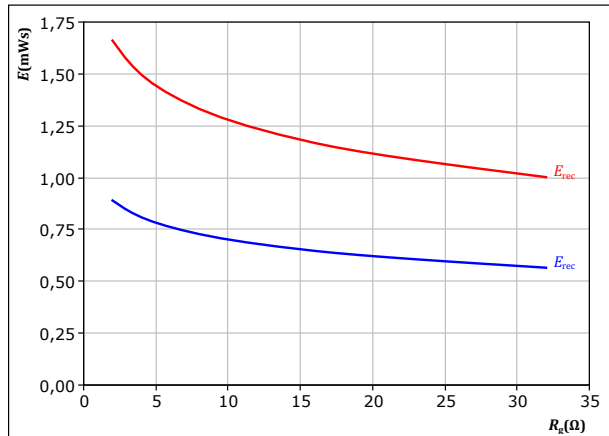

With an inductive load at

$V_{CE} = 350$ V
 $V_{GE} = \pm 15$ V
 $I_c = 75$ A

T_j : — 25 °C
 — 125 °C



Buck Switching Characteristics

figure 22. IGBT

Typical switching times as a function of collector current
 $t = f(I_c)$

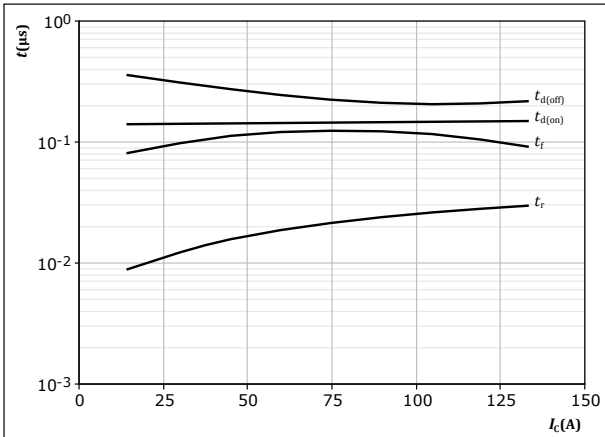

With an inductive load at
 $T_j = 125 \text{ }^\circ\text{C}$
 $V_{CE} = 350 \text{ V}$
 $V_{GE} = \pm 15 \text{ V}$
 $R_{gon} = 8 \text{ } \Omega$
 $R_{goff} = 8 \text{ } \Omega$

figure 23. IGBT

Typical switching times as a function of IGBT turn on gate resistor
 $t = f(R_g)$

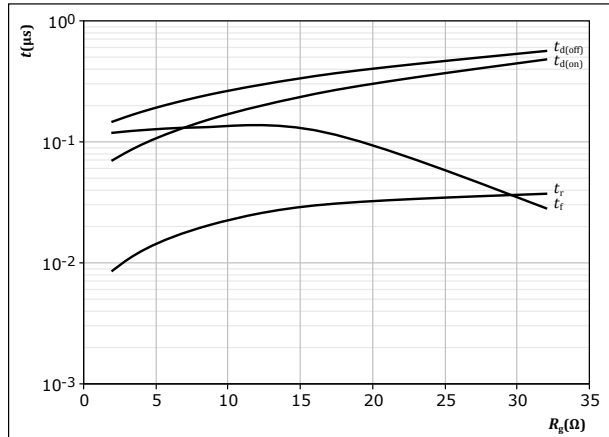

With an inductive load at
 $T_j = 125 \text{ }^\circ\text{C}$
 $V_{CE} = 350 \text{ V}$
 $V_{GE} = \pm 15 \text{ V}$
 $I_c = 75 \text{ A}$

figure 24. FWD

Typical reverse recovery time as a function of collector current
 $t_{rr} = f(I_c)$

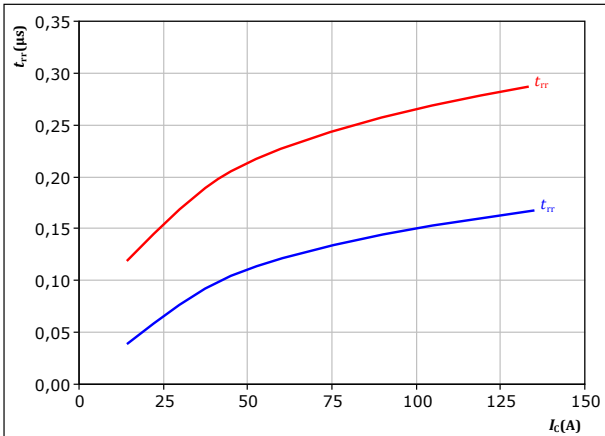

With an inductive load at
 $V_{CE} = 350 \text{ V}$
 $V_{GE} = \pm 15 \text{ V}$
 $R_{gon} = 8 \text{ } \Omega$

T_j : — 25 °C
 — 125 °C

figure 25. FWD

Typical reverse recovery time as a function of IGBT turn on gate resistor
 $t_{rr} = f(R_{gon})$

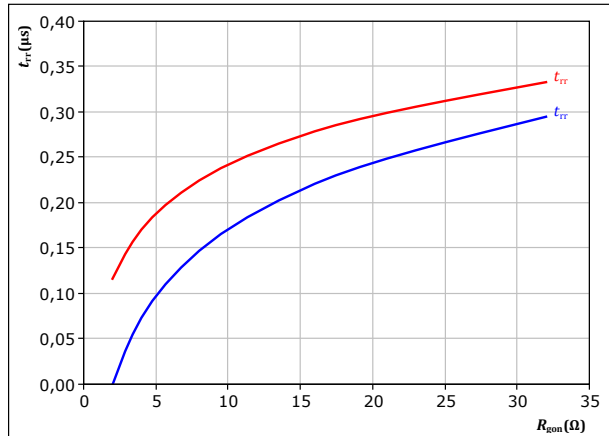

With an inductive load at
 $V_{CE} = 350 \text{ V}$
 $V_{GE} = \pm 15 \text{ V}$
 $I_c = 75 \text{ A}$

T_j : — 25 °C
 — 125 °C



Buck Switching Characteristics

figure 26. FWD

Typical recovered charge as a function of collector current

$$Q_r = f(I_c)$$

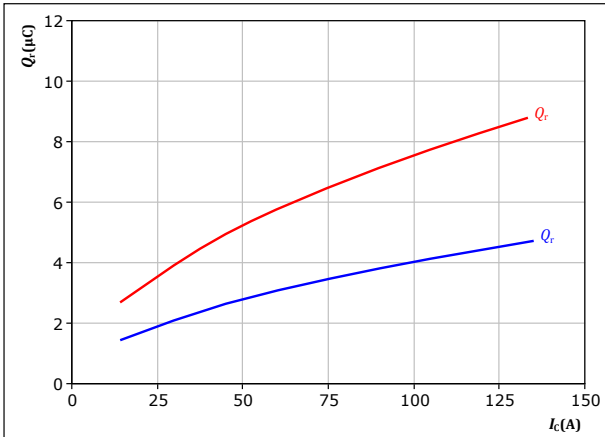

With an inductive load at

$V_{CE} = 350$ V
 $V_{GE} = \pm 15$ V
 $R_{gon} = 8$ Ω

T_j : — 25 °C
— 125 °C

figure 27. FWD

Typical recovered charge as a function of IGBT turn on gate resistor

$$Q_r = f(R_{gon})$$

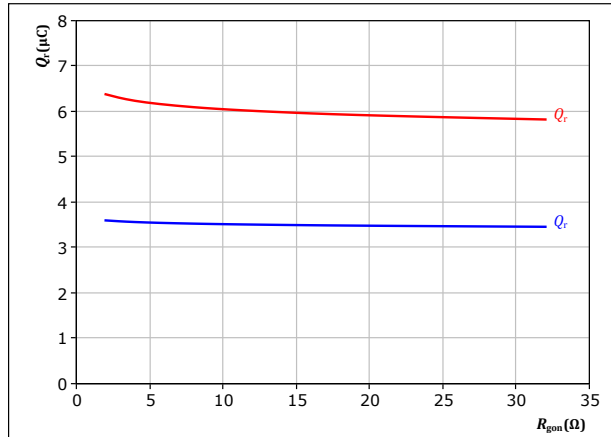

With an inductive load at

$V_{CE} = 350$ V
 $V_{GE} = \pm 15$ V
 $I_c = 75$ A

T_j : — 25 °C
— 125 °C

figure 28. FWD

Typical peak reverse recovery current as a function of collector current

$$I_{RM} = f(I_c)$$

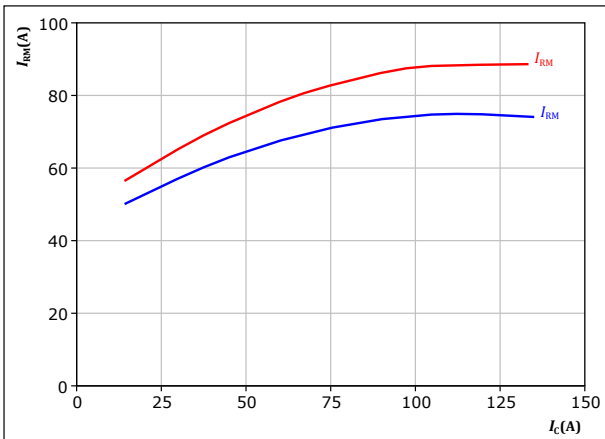

With an inductive load at

$V_{CE} = 350$ V
 $V_{GE} = \pm 15$ V
 $R_{gon} = 8$ Ω

T_j : — 25 °C
— 125 °C

figure 29. FWD

Typical peak reverse recovery current as a function of IGBT turn on gate resistor

$$I_{RM} = f(R_{gon})$$

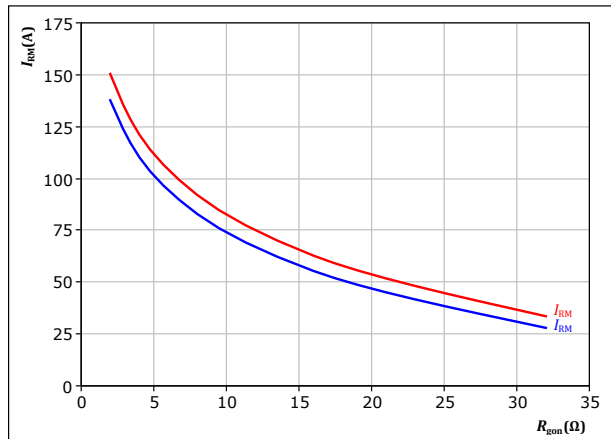

With an inductive load at

$V_{CE} = 350$ V
 $V_{GE} = \pm 15$ V
 $I_c = 75$ A

T_j : — 25 °C
— 125 °C



Buck Switching Characteristics

figure 30. FWD

Typical rate of fall of forward and reverse recovery current as a function of collector current
 $di_f/dt, di_r/dt = f(I_c)$

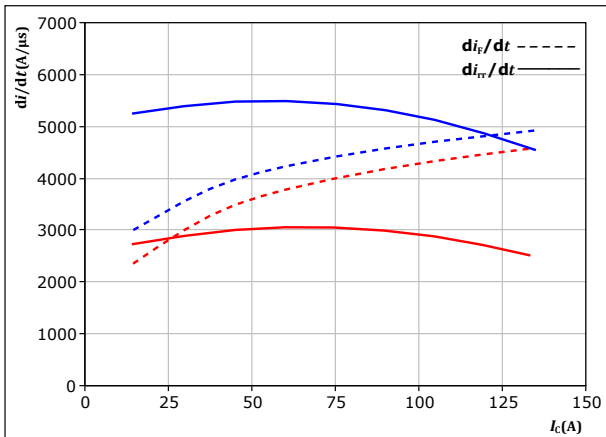

With an inductive load at

$V_{CE} = 350$ V
 $V_{GE} = \pm 15$ V
 $R_{gon} = 8$ Ω

T_j : — 25 °C
 — 125 °C

figure 31. FWD

Typical rate of fall of forward and reverse recovery current as a function of turn on gate resistor
 $di_f/dt, di_r/dt = f(R_{gon})$

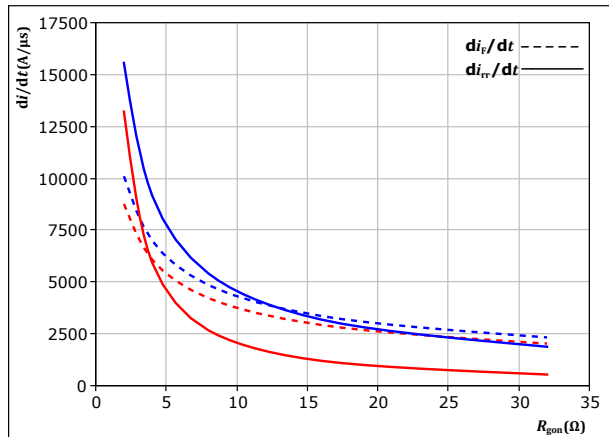

With an inductive load at

$V_{CE} = 350$ V
 $V_{GE} = \pm 15$ V
 $I_c = 75$ A

T_j : — 25 °C
 — 125 °C

figure 32. IGBT

Reverse bias safe operating area

$I_c = f(V_{CE})$

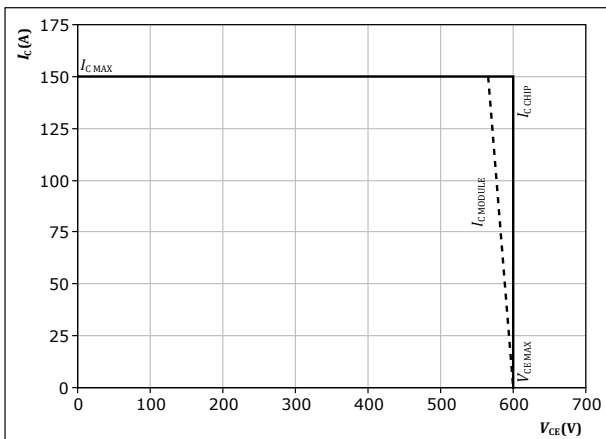

At $T_j = 125$ °C
 $R_{gon} = 8$ Ω
 $R_{goff} = 8$ Ω



Boost Switching Characteristics

figure 33. IGBT

Typical switching energy losses as a function of collector current
 $E = f(I_c)$

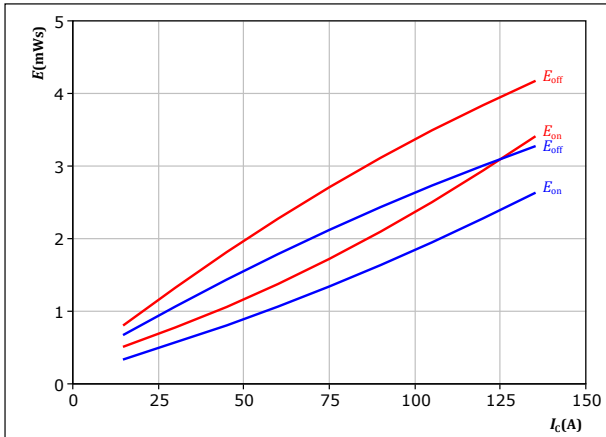

With an inductive load at

$V_{CE} = 350 \text{ V}$
 $V_{GE} = \pm 15 \text{ V}$
 $R_{gon} = 8 \ \Omega$
 $R_{goff} = 8 \ \Omega$

T_j: — 25 °C
 — 125 °C

figure 34. IGBT

Typical switching energy losses as a function of IGBT turn on gate resistor
 $E = f(R_g)$

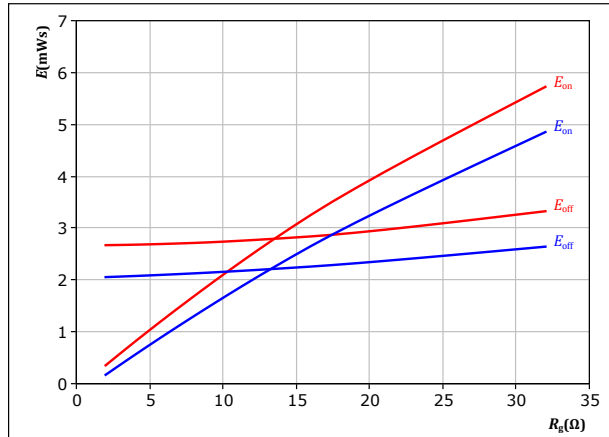

With an inductive load at

$V_{CE} = 350 \text{ V}$
 $V_{GE} = \pm 15 \text{ V}$
 $I_c = 75 \text{ A}$

T_j: — 25 °C
 — 125 °C

figure 35. FWD

Typical reverse recovered energy loss as a function of collector current
 $E_{rec} = f(I_c)$

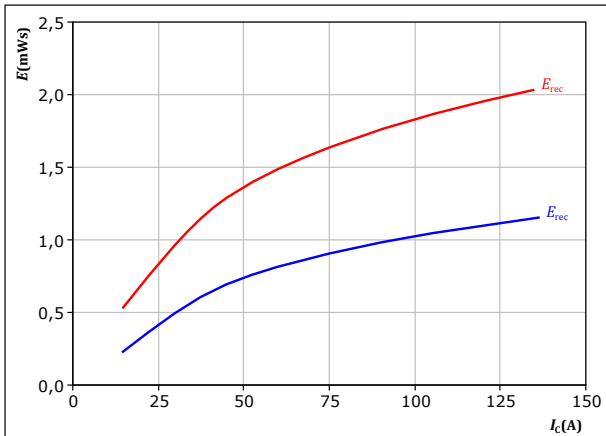

With an inductive load at

$V_{CE} = 350 \text{ V}$
 $V_{GE} = \pm 15 \text{ V}$
 $R_{gon} = 8 \ \Omega$

T_j: — 25 °C
 — 125 °C

figure 36. FWD

Typical reverse recovered energy loss as a function of IGBT turn on gate resistor
 $E_{rec} = f(R_g)$

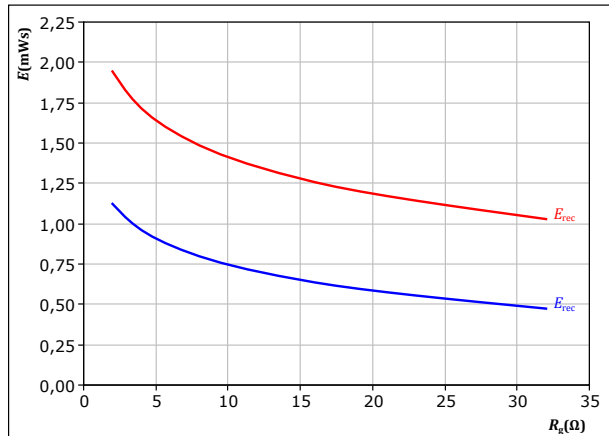

With an inductive load at

$V_{CE} = 350 \text{ V}$
 $V_{GE} = \pm 15 \text{ V}$
 $I_c = 75 \text{ A}$

T_j: — 25 °C
 — 125 °C



Boost Switching Characteristics

figure 37. IGBT

Typical switching times as a function of collector current
 $t = f(I_c)$

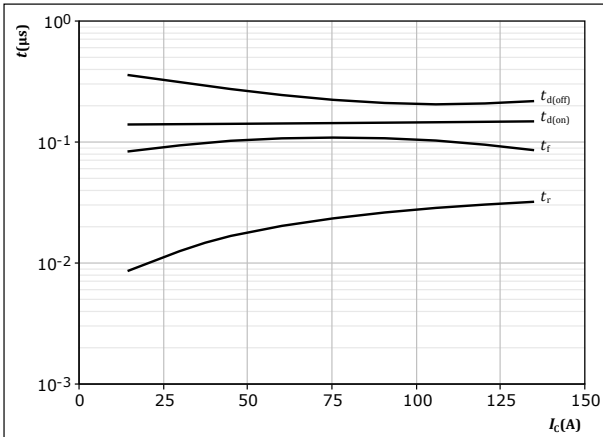

With an inductive load at
 $T_j = 125 \text{ } ^\circ\text{C}$
 $V_{CE} = 350 \text{ V}$
 $V_{GE} = \pm 15 \text{ V}$
 $R_{gon} = 8 \text{ } \Omega$
 $R_{goff} = 8 \text{ } \Omega$

figure 38. IGBT

Typical switching times as a function of IGBT turn on gate resistor
 $t = f(R_g)$

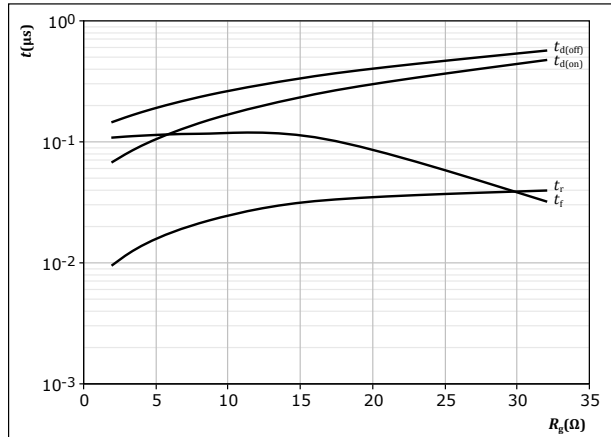

With an inductive load at
 $T_j = 125 \text{ } ^\circ\text{C}$
 $V_{CE} = 350 \text{ V}$
 $V_{GE} = \pm 15 \text{ V}$
 $I_c = 75 \text{ A}$

figure 39. FWD

Typical reverse recovery time as a function of collector current
 $t_{rr} = f(I_c)$

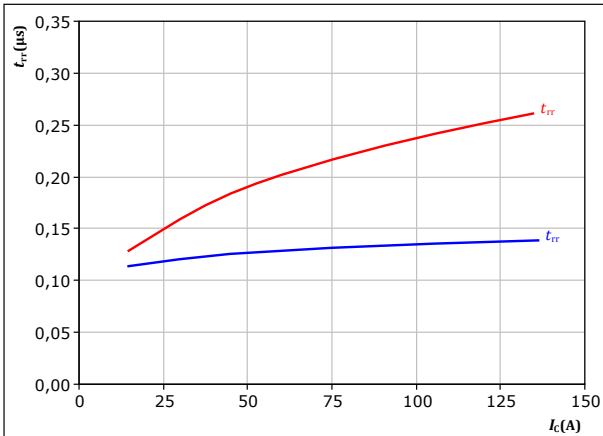

With an inductive load at
 $V_{CE} = 350 \text{ V}$
 $V_{GE} = \pm 15 \text{ V}$
 $R_{gon} = 8 \text{ } \Omega$
 $T_j: \text{ — } 25 \text{ } ^\circ\text{C}$
 $\text{ — } 125 \text{ } ^\circ\text{C}$

figure 40. FWD

Typical reverse recovery time as a function of IGBT turn on gate resistor
 $t_{rr} = f(R_{gon})$

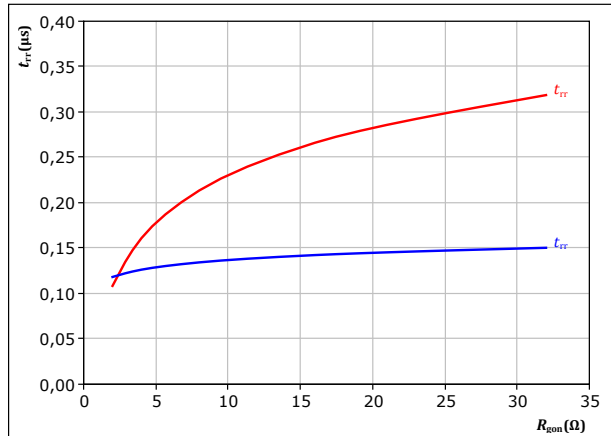

With an inductive load at
 $V_{CE} = 350 \text{ V}$
 $V_{GE} = \pm 15 \text{ V}$
 $I_c = 75 \text{ A}$
 $T_j: \text{ — } 25 \text{ } ^\circ\text{C}$
 $\text{ — } 125 \text{ } ^\circ\text{C}$



Boost Switching Characteristics

figure 41. FWD

Typical recovered charge as a function of collector current

$$Q_r = f(I_c)$$

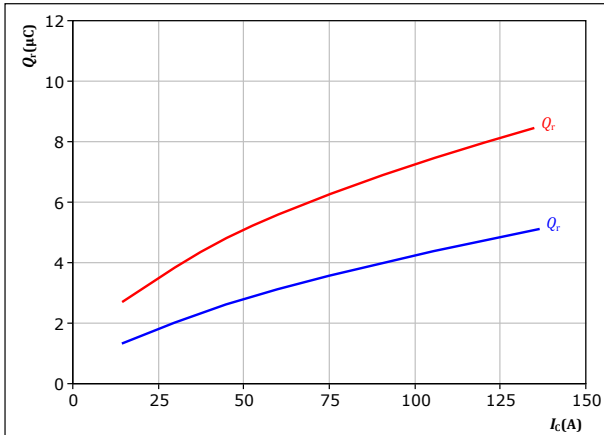

With an inductive load at

$V_{CE} = 350$ V
 $V_{GE} = \pm 15$ V
 $R_{gon} = 8$ Ω

T_j : — 25 °C
— 125 °C

figure 42. FWD

Typical recovered charge as a function of IGBT turn on gate resistor

$$Q_r = f(R_{gon})$$

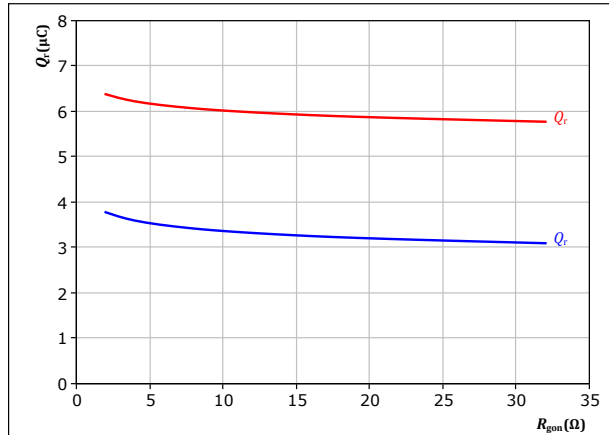

With an inductive load at

$V_{CE} = 350$ V
 $V_{GE} = \pm 15$ V
 $I_c = 75$ A

T_j : — 25 °C
— 125 °C

figure 43. FWD

Typical peak reverse recovery current as a function of collector current

$$I_{RM} = f(I_c)$$

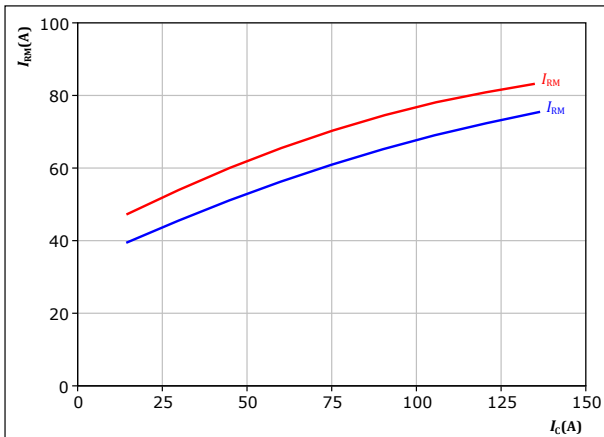

With an inductive load at

$V_{CE} = 350$ V
 $V_{GE} = \pm 15$ V
 $R_{gon} = 8$ Ω

T_j : — 25 °C
— 125 °C

figure 44. FWD

Typical peak reverse recovery current as a function of IGBT turn on gate resistor

$$I_{RM} = f(R_{gon})$$

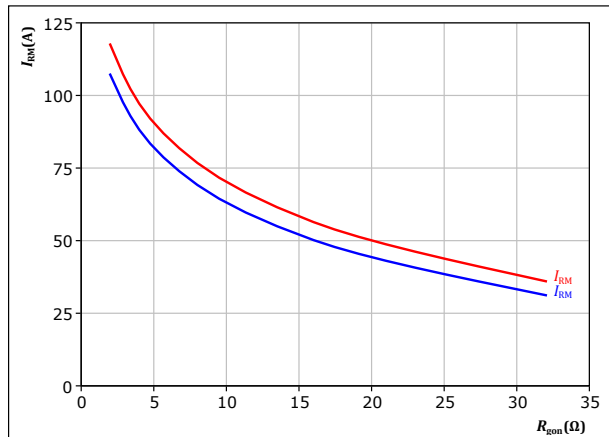

With an inductive load at

$V_{CE} = 350$ V
 $V_{GE} = \pm 15$ V
 $I_c = 75$ A

T_j : — 25 °C
— 125 °C



Boost Switching Characteristics

figure 45. FWD

Typical rate of fall of forward and reverse recovery current as a function of collector current
 $di_f/dt, di_r/dt = f(I_c)$

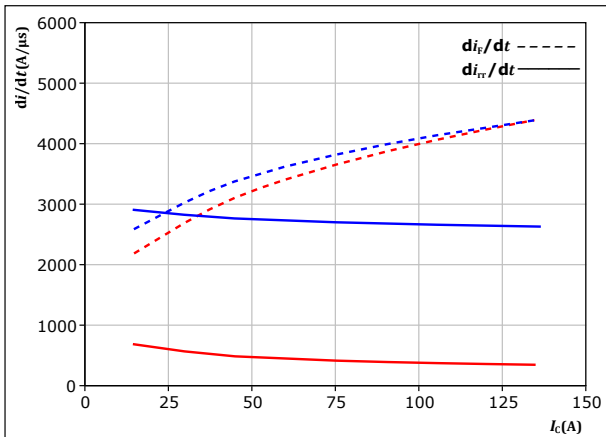

With an inductive load at

$V_{CE} = 350$ V
 $V_{GE} = \pm 15$ V
 $R_{gon} = 8$ Ω

T_j : — 25 °C
 — 125 °C

figure 46. FWD

Typical rate of fall of forward and reverse recovery current as a function of turn on gate resistor
 $di_f/dt, di_r/dt = f(R_{gon})$

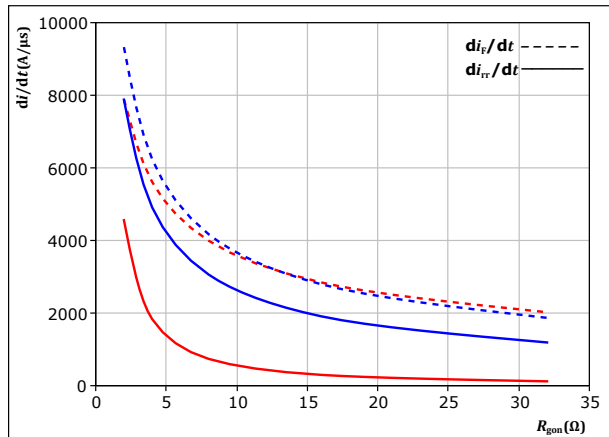

With an inductive load at

$V_{CE} = 350$ V
 $V_{GE} = \pm 15$ V
 $I_c = 75$ A

T_j : — 25 °C
 — 125 °C

figure 47. IGBT

Reverse bias safe operating area

$I_c = f(V_{CE})$

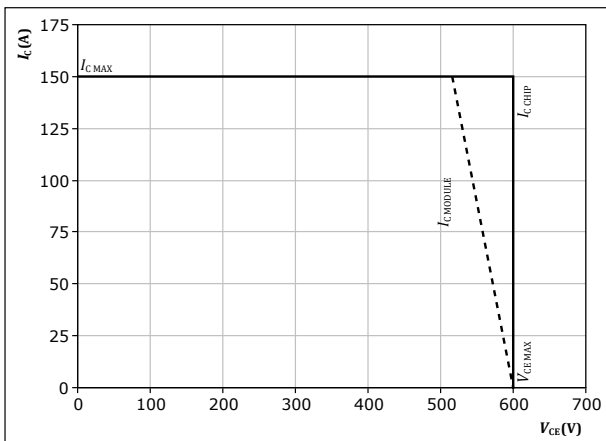

At $T_j = 125$ °C
 $R_{gon} = 8$ Ω
 $R_{goff} = 8$ Ω



Switching Definitions

figure 48. IGBT

Turn-off Switching Waveforms & definition of t_{doff} , t_{Eoff} (t_{Eoff} = integrating time for E_{off})

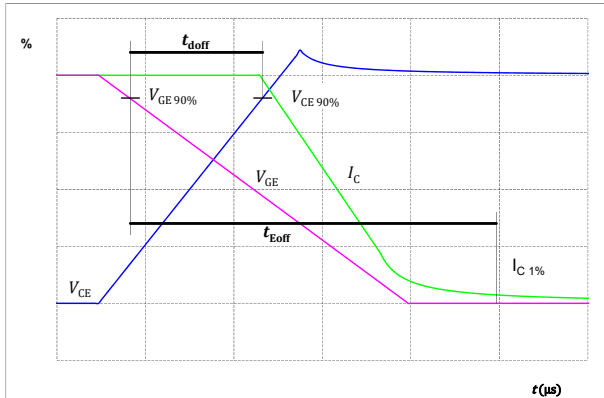

figure 49. IGBT

Turn-on Switching Waveforms & definition of t_{don} , t_{Eon} (t_{Eon} = integrating time for E_{on})

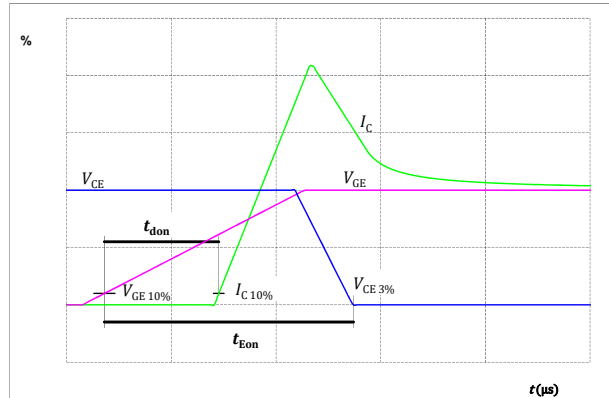

figure 50. IGBT

Turn-off Switching Waveforms & definition of t_f

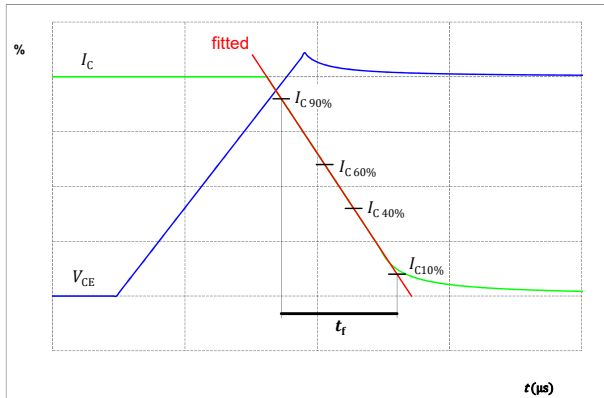
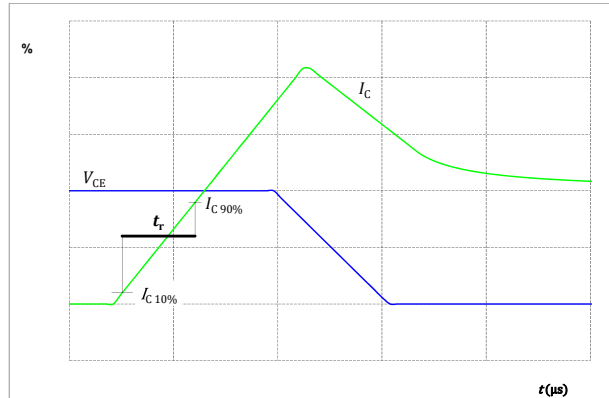

figure 51. IGBT

Turn-on Switching Waveforms & definition of t_r





Switching Definitions

figure 52. FWD

Turn-off Switching Waveforms & definition of t_{rr}

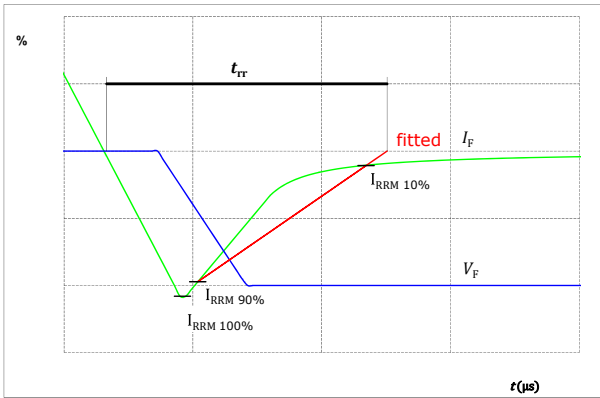
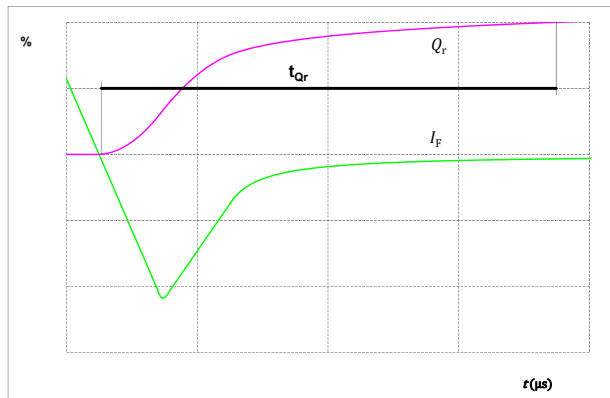

figure 53. FWD

Turn-on Switching Waveforms & definition of t_{Qr} (t_{Qr} = integrating time for Q_r)





Vincotech

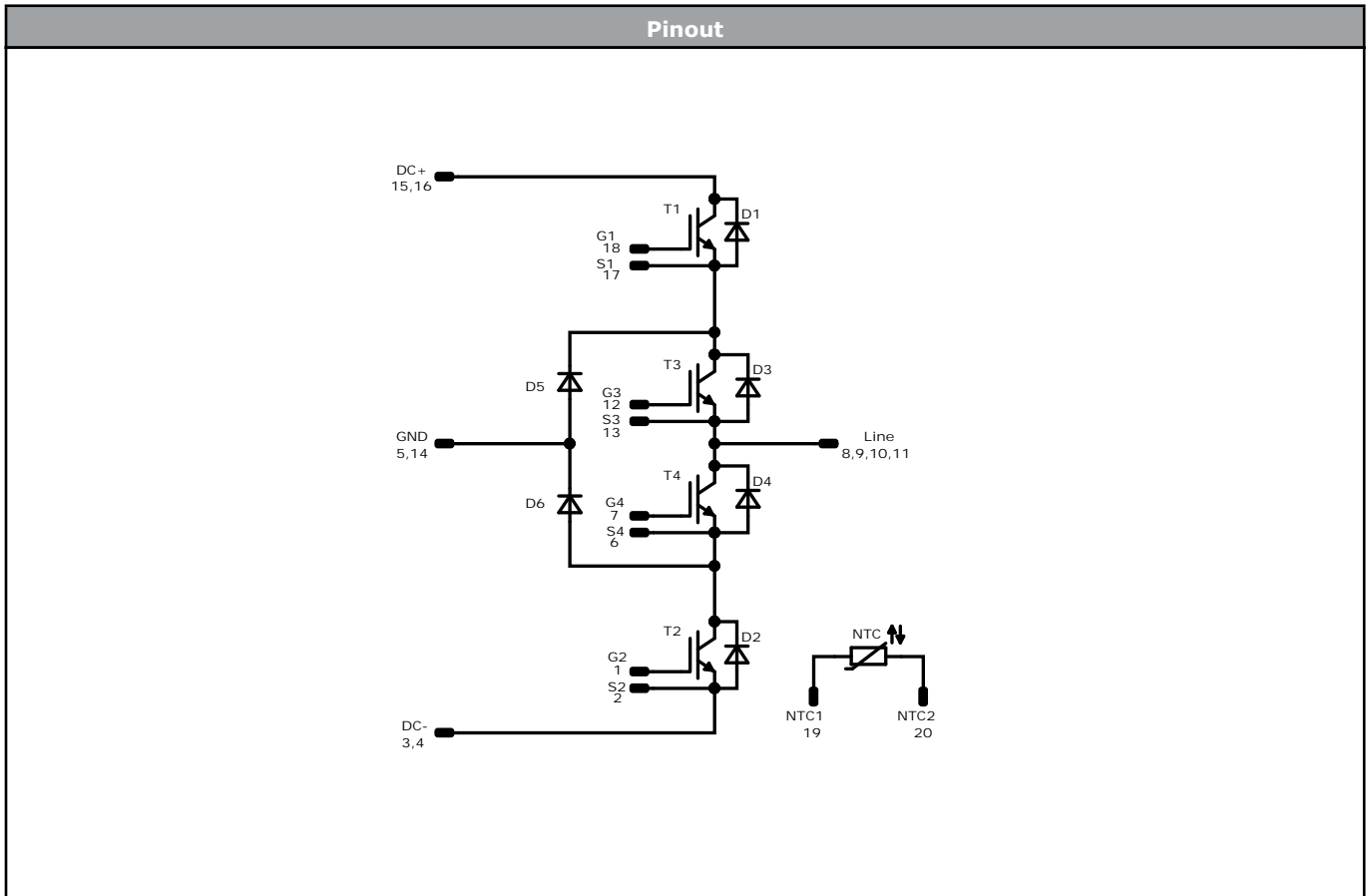

Identification					
ID	Component	Voltage	Current	Function	Comment
T1, T2	IGBT	600 V	75 A	Buck Switch	
D5, D6	FWD	600 V	75 A	Buck Diode	
T3, T4	IGBT	600 V	75 A	Boost Switch	
D2, D1	FWD	600 V	75 A	Boost Diode	
D4, D3	FWD	600 V	75 A	Boost Sw. Inv. Diode	
NTC	Thermistor			Thermistor	



Vincotech

Packaging instruction				
Standard packaging quantity (SPQ) 135	>SPQ	Standard	<SPQ	Sample

Handling instruction
Handling instructions for <i>flow 0</i> packages see vincotech.com website.

Package data
Package data for <i>flow 0</i> packages see vincotech.com website.

Vincotech thermistor reference
See Vincotech thermistor reference table at vincotech.com website.

UL recognition and file number
This device is certified according to UL 1557 standard, UL file number E192116. For more information see vincotech.com website. 

Document No.:	Date:	Modification:	Pages
10-PZ06NIA075SA-P926F33Y-D2-14	31 Jul. 2022	New Datasheet format, module is unchanged Introduce Rth values with PSX-P7	

DISCLAIMER

The information, specifications, procedures, methods and recommendations herein (together "information") are presented by Vincotech to reader in good faith, are believed to be accurate and reliable, but may well be incomplete and/or not applicable to all conditions or situations that may exist or occur. Vincotech reserves the right to make any changes without further notice to any products to improve reliability, function or design. No representation, guarantee or warranty is made to reader as to the accuracy, reliability or completeness of said information or that the application or use of any of the same will avoid hazards, accidents, losses, damages or injury of any kind to persons or property or that the same will not infringe third parties rights or give desired results. It is reader's sole responsibility to test and determine the suitability of the information and the product for reader's intended use.

LIFE SUPPORT POLICY

Vincotech products are not authorised for use as critical components in life support devices or systems without the express written approval of Vincotech.

As used herein:

1. Life support devices or systems are devices or systems which, (a) are intended for surgical implant into the body, or (b) support or sustain life, or (c) whose failure to perform when properly used in accordance with instructions for use provided in labelling can be reasonably expected to result in significant injury to the user.
2. A critical component is any component of a life support device or system whose failure to perform can be reasonably expected to cause the failure of the life support device or system, or to affect its safety or effectiveness.