



flowPFC 0 CD

650 V / 50 A

Topology features

- Dual Boost PFC
- Current sense interface in the collector with low inductive bypass diode
- Integrated Shunt Resistor with protection Diode
- Integrated DC capacitor
- Temperature sensor

Component features

- High efficiency in hard switching and resonant topologies
- High speed switching
- Low gate charge

Housing features

- Base isolation: Al₂O₃
- Clip-in, reliable mechanical connection, qualified for wave soldering
- Convex shaped substrate for superior thermal contact
- Thermo-mechanical push-and-pull force relief
- Solder pin

Target applications

- Power Supply
- Welding & Cutting

Types

- 10-FZ062TA050SM-P987D13

flow 0 12 mm housing

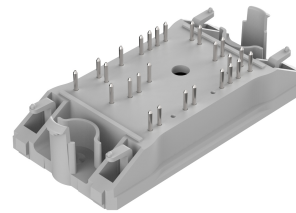

Schematic

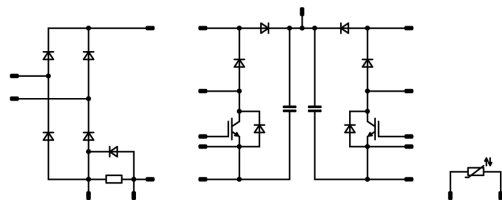



Vincotech

Maximum Ratings

$T_j = 25\text{ °C}$, unless otherwise specified

Parameter	Symbol	Conditions	Value	Unit
PFC Switch				
Collector-emitter voltage	V_{CES}		650	V
Collector current (DC current)	I_C	$T_j = T_{jmax}$ $T_s = 80\text{ °C}$	43	A
Repetitive peak collector current	I_{CRM}	t_p limited by T_{jmax}	150	A
Total power dissipation	P_{tot}	$T_j = T_{jmax}$ $T_s = 80\text{ °C}$	84	W
Gate-emitter voltage	V_{GES}		± 20	V
Maximum junction temperature	T_{jmax}		175	°C

PFC Diode

Peak repetitive reverse voltage	V_{RRM}		600	V
Forward current (DC current)	I_F	$T_j = T_{jmax}$ $T_s = 80\text{ °C}$	48	A
Repetitive peak forward current	I_{FRM}	t_p limited by T_{jmax}	60	A
Surge (non-repetitive) forward current	I_{FSM}	Single Half Sine Wave, $t_p = 10\text{ ms}$ $T_j = 25\text{ °C}$	310	A
Total power dissipation	P_{tot}	$T_j = T_{jmax}$ $T_s = 80\text{ °C}$	63	W
Maximum junction temperature	T_{jmax}		175	°C

PFC Sw. Protection Diode

Peak repetitive reverse voltage	V_{RRM}		650	V
Forward current (DC current)	I_F	$T_j = T_{jmax}$ $T_s = 80\text{ °C}$	17	A
Repetitive peak forward current	I_{FRM}	t_p limited by T_{jmax}	20	A
Total power dissipation	P_{tot}	$T_j = T_{jmax}$ $T_s = 80\text{ °C}$	33	W
Maximum junction temperature	T_{jmax}		175	°C



Vincotech

Maximum Ratings

$T_j = 25\text{ °C}$, unless otherwise specified

Parameter	Symbol	Conditions	Value	Unit
-----------	--------	------------	-------	------

Current Transformer Protection Diode

Peak repetitive reverse voltage	V_{RRM}		650	V
Forward current (DC current)	I_F	$T_j = T_{jmax}$ $T_s = 80\text{ °C}$	17	A
Repetitive peak forward current	I_{FRM}	I_p limited by T_{jmax}	20	A
Total power dissipation	P_{tot}	$T_j = T_{jmax}$ $T_s = 80\text{ °C}$	33	W
Maximum junction temperature	T_{jmax}		175	°C

Shunt Protection Diode

Peak repetitive reverse voltage	V_{RRM}		1600	V
Forward current (DC current)	I_F	$T_j = T_{jmax}$ $T_s = 80\text{ °C}$	45	A
Surge (non-repetitive) forward current	I_{FSM}	Single Half Sine Wave, $t_p = 10\text{ ms}$ $T_j = 150\text{ °C}$	280	A
Surge current capability	I^2t		390	A ² s
Total power dissipation	P_{tot}	$T_j = T_{jmax}$ $T_s = 80\text{ °C}$	59	W
Maximum junction temperature	T_{jmax}		150	°C

Rectifier Diode

Peak repetitive reverse voltage	V_{RRM}		1600	V
Forward current (DC current)	I_F	$T_j = T_{jmax}$ $T_s = 80\text{ °C}$	45	A
Surge (non-repetitive) forward current	I_{FSM}	Single Half Sine Wave, $t_p = 10\text{ ms}$ $T_j = 150\text{ °C}$	280	A
Surge current capability	I^2t		390	A ² s
Total power dissipation	P_{tot}	$T_j = T_{jmax}$ $T_s = 80\text{ °C}$	59	W
Maximum junction temperature	T_{jmax}		150	°C

PFC Shunt

DC current	I		32	A
Power dissipation	P_{tot}	$T_c = 70\text{ °C}$	7	W
Operation Temperature	T_{op}		-55 ... 170	°C



Vincotech

10-FZ062TA050SM-P987D13
datasheet

Maximum Ratings

$T_j = 25\text{ °C}$, unless otherwise specified

Parameter	Symbol	Conditions	Value	Unit
Capacitor (DC)				
Maximum DC voltage	V_{MAX}		1000	V
Operation Temperature	T_{op}		-55 ... 125	°C

Module Properties

Thermal Properties

Storage temperature	T_{stg}		-40...+125	°C
Operation temperature under switching condition	T_{jop}		-40...+($T_{jmax} - 25$)	°C

Isolation Properties

Isolation voltage	V_{isol}	DC Test Voltage* $t_p = 2\text{ s}$	6000	V
Isolation voltage	V_{isol}	AC Voltage $t_p = 1\text{ min}$	2500	V
Creepage distance			>12,7	mm
Clearance			8,99	mm
Comparative Tracking Index	CTI		≥ 200	

*100 % tested in production



Vincotech

Characteristic Values

Parameter	Symbol	Conditions					Values			Unit
		V_{GS} [V]	V_{GE} [V]	V_{DS} [V]	V_F [V]	I_C [A] I_D [A] I_F [A]	T_j [°C]	Min	Typ	

PFC Switch

Static

Gate-emitter threshold voltage	$V_{GE(th)}$	$V_{CE} = V_{GE}$			0,0005	25	3,3	4	4,7	V
Collector-emitter saturation voltage	$V_{CE(sat)}$		15		50	25 125		1,83 2,01	2,22 ⁽¹⁾	V
Collector-emitter cut-off current	I_{CES}		0	650		25			40	μA
Gate-emitter leakage current	I_{GES}		20	0		25			120	nA
Internal gate resistance	r_g							None		Ω
Input capacitance	C_{ies}							3000		pF
Output capacitance	C_{oes}	$f = 1$ Mhz	0	25		25		50		pF
Reverse transfer capacitance	C_{res}							11		pF
Gate charge	Q_g		15	520	50	25		120		nC

Thermal

Thermal resistance junction to sink ⁽²⁾	$R_{th(j-s)}$	$\lambda_{paste} = 3,4$ W/mK (PSX)						1,13		K/W
--	---------------	---------------------------------------	--	--	--	--	--	------	--	-----

Dynamic

Turn-on delay time	$t_{d(on)}$					25 125 150		18,86 18,39 18,5		ns
Rise time	t_r					25 125 150		11,39 12,87 13,01		ns
Turn-off delay time	$t_{d(off)}$					25 125 150		123,04 139,07 143,26		ns
Fall time	t_f					25 125 150		9 7,04 9,07		ns
Turn-on energy (per pulse)	E_{on}	$Q_{tFWD} = 0,523$ μC $Q_{tFWD} = 1,6$ μC $Q_{tFWD} = 2$ μC				25 125 150		0,72 1,04 1,13		mWs
Turn-off energy (per pulse)	E_{off}					25 125 150		0,332 0,48 0,514		mWs



Vincotech

Characteristic Values

Parameter	Symbol	Conditions					Values			Unit
		V_{GE} [V] V_{GS} [V]	V_{CE} [V] V_{DS} [V] V_F [V]	I_C [A] I_D [A] I_F [A]	T_j [°C]	Min	Typ	Max		
PFC Diode										
Static										
Forward voltage	V_F				30	25 125 150		1,67 1,33 1,24	2,5 ⁽¹⁾	V
Reverse leakage current	I_R	$V_T = 600$ V				25			20	μA
Thermal										
Thermal resistance junction to sink ⁽²⁾	$R_{th(j-s)}$	$\lambda_{paste} = 3,4$ W/mK (PSX)						1,5		K/W
Dynamic										
Peak recovery current	I_{RM}					25 125 150		34,11 54,83 62,42		A
Reverse recovery time	t_{rr}					25 125 150		30,67 53,6 58,79		ns
Recovered charge	Q_r	$di/dt=3557$ A/μs $di/dt=2840$ A/μs $di/dt=3262$ A/μs	0/15	400	50	25 125 150		0,523 1,6 2		μC
Reverse recovered energy	E_{rec}					25 125 150		0,073 0,294 0,377		mWs
Peak rate of fall of recovery current	$(di_r/dt)_{max}$					25 125 150		2927,79 2115,26 2340,37		A/μs



Vincotech

Characteristic Values

Parameter	Symbol	Conditions					Values			Unit
		V_{GE} [V] V_{GS} [V]	V_{CE} [V] V_{DS} [V] V_F [V]	I_C [A] I_D [A] I_F [A]	T_j [°C]	Min	Typ	Max		

PFC Sw. Protection Diode

Static

Forward voltage	V_F				10	25 125	1,23	1,67 1,56	1,87 ⁽¹⁾	V
Reverse leakage current	I_R	$V_r = 650$ V				25			0,14	μA

Thermal

Thermal resistance junction to sink ⁽²⁾	$R_{th(j-s)}$	$\lambda_{paste} = 3,4$ W/mK (PSX)						2,87		K/W
--	---------------	---------------------------------------	--	--	--	--	--	------	--	-----

Current Transformer Protection Diode

Static

Forward voltage	V_F				10	25 125	1,23	1,67 1,56	1,87 ⁽¹⁾	V
Reverse leakage current	I_R	$V_r = 650$ V				25			0,14	μA

Thermal

Thermal resistance junction to sink ⁽²⁾	$R_{th(j-s)}$	$\lambda_{paste} = 3,4$ W/mK (PSX)						2,87		K/W
--	---------------	---------------------------------------	--	--	--	--	--	------	--	-----

Shunt Protection Diode

Static

Forward voltage	V_F				50	25 125		1,32 1,33	1,3 ⁽¹⁾ 1,33 ⁽¹⁾	V
Reverse leakage current	I_R	$V_r = 1600$ V				25 150			20 1500	μA

Thermal

Thermal resistance junction to sink ⁽²⁾	$R_{th(j-s)}$	$\lambda_{paste} = 3,4$ W/mK (PSX)						1,2		K/W
--	---------------	---------------------------------------	--	--	--	--	--	-----	--	-----



Vincotech

Characteristic Values

Parameter	Symbol	Conditions					Values			Unit
		V_{GE} [V] V_{GS} [V]	V_{CE} [V] V_{DS} [V] V_F [V]	I_C [A] I_D [A] I_F [A]	T_j [°C]	Min	Typ	Max		

Rectifier Diode

Static

Forward voltage	V_F				50	25 125		1,32 1,33	1,3 ⁽¹⁾ 1,33 ⁽¹⁾	V
Reverse leakage current	I_R	$V_i = 1600$ V				25 150			20 1500	μA

Thermal

Thermal resistance junction to sink ⁽²⁾	$R_{th(j-s)}$	$\lambda_{paste} = 3,4$ W/mK (PSX)						1,2		K/W
--	---------------	---------------------------------------	--	--	--	--	--	-----	--	-----

PFC Shunt

Static

Resistance	R							6,8		mΩ
Tolerance							-1		1	%
Temperature coefficient	tc								100	ppm/K

Capacitor (DC)

Static

Capacitance	C	DC bias voltage = 0 V				25		100		nF
Tolerance							10		10	%
Dissipation factor		$f = 1$ kHz				25		2,5		%



Vincotech

Characteristic Values

Parameter	Symbol	Conditions					Values			Unit
		V_{GS} [V]	V_{GE} [V]	V_{DS} [V]	V_{CE} [V]	T_j [°C]	Min	Typ	Max	

Thermistor

Static

Rated resistance	R					25		22		kΩ
Deviation of R_{100}	$A_{R/R}$	$R_{100} = 1484 \Omega$				100	-5		5	%
Power dissipation	P					25		130		mW
Power dissipation constant	d					25		1,5		mW/K
B-value	$B_{(25/50)}$	Tol. $\pm 1 \%$						3962		K
B-value	$B_{(25/100)}$	Tol. $\pm 1 \%$						4000		K
Vincotech Thermistor Reference									I	

⁽¹⁾ Value at chip level

⁽²⁾ Only valid with pre-applied Vincotech thermal interface material.



PFC Switch Characteristics

figure 1. IGBT

Typical output characteristics

$$I_C = f(V_{CE})$$

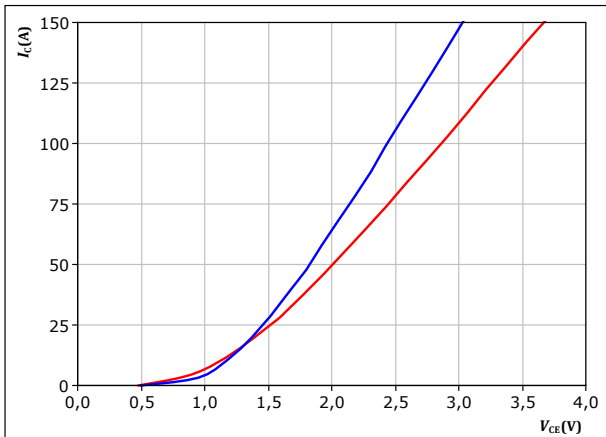

$t_p = 250 \mu s$
 $V_{GE} = 15 V$
 T_j : — 25 °C
— 125 °C

figure 2. IGBT

Typical output characteristics

$$I_C = f(V_{CE})$$

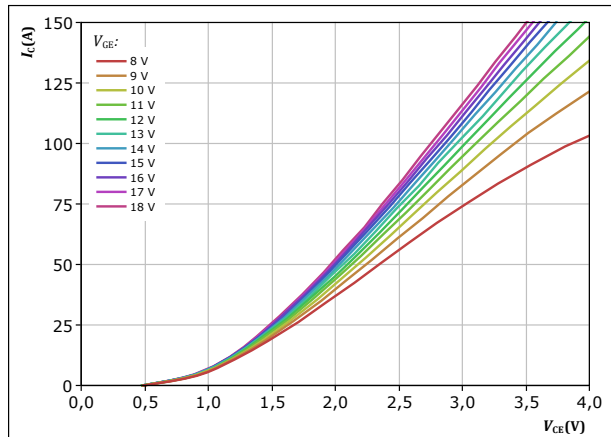

$t_p = 250 \mu s$
 $T_j = 125 \text{ } ^\circ C$
 V_{GE} from 8 V to 18 V in steps of 1 V

figure 3. IGBT

Typical transfer characteristics

$$I_C = f(V_{GE})$$

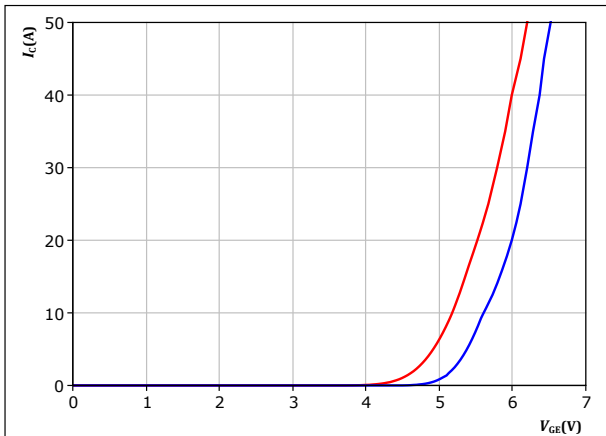

$t_p = 250 \mu s$
 $V_{CE} = 10 V$
 T_j : — 25 °C
— 125 °C

figure 4. IGBT

Transient thermal impedance as a function of pulse width

$$Z_{th(j-s)} = f(t_p)$$

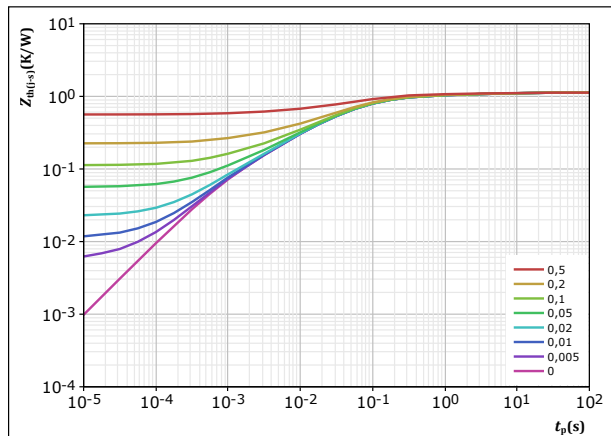

$D = t_p / T$
 $R_{th(j-s)} = 1,126 \text{ K/W}$
IGBT thermal model values

R (K/W)	τ (s)
7,12E-02	8,15E+00
1,29E-01	6,00E-01
4,31E-01	9,13E-02
3,15E-01	2,59E-02
1,31E-01	5,80E-03
5,02E-02	8,53E-04



PFC Switch Characteristics

figure 5. IGBT

Safe operating area
 $I_C = f(V_{CE})$

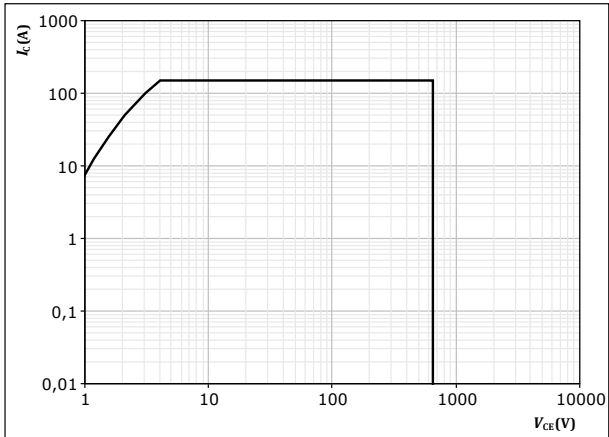

$D =$ single pulse
 $T_s = 80$ °C
 $V_{GE} = 15$ V
 $T_j = T_{jmax}$

figure 6. IGBT

Gate voltage vs gate charge
 $V_{GE} = f(Q_g)$

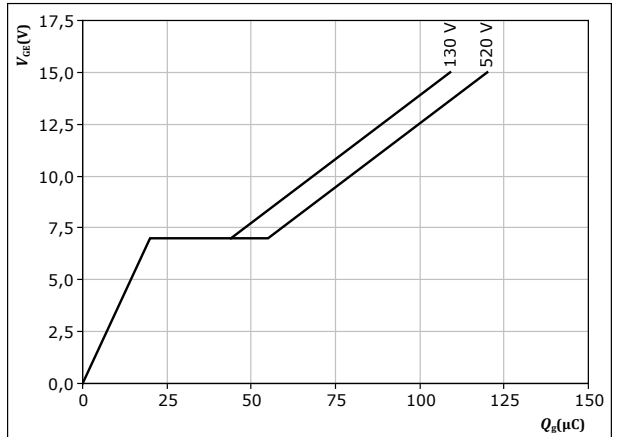

$I_C = 50$ A
 $T_j = 25$ °C



PFC Diode Characteristics

figure 7. FWD

Typical forward characteristics

$$I_F = f(V_F)$$

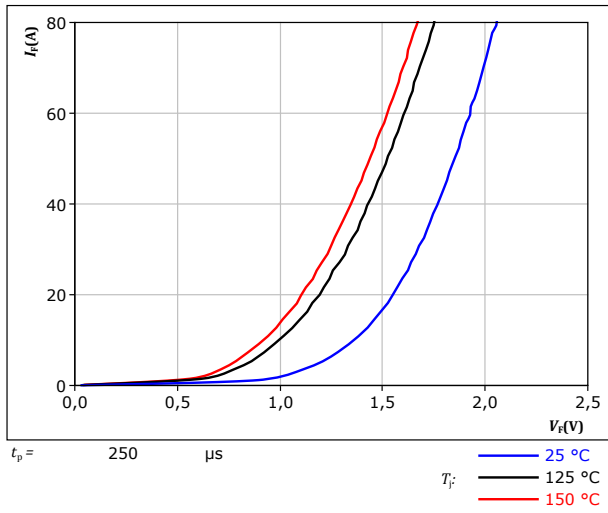
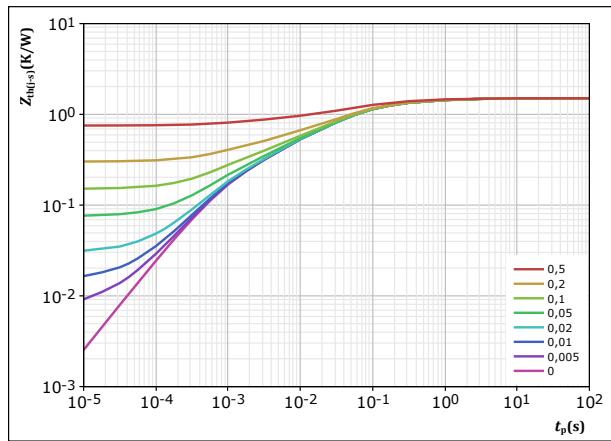

figure 8. FWD

Transient thermal impedance as a function of pulse width

$$Z_{th(j-s)} = f(t_p)$$





PFC Sw. Protection Diode Characteristics

figure 9. FWD

Typical forward characteristics

$$I_F = f(V_F)$$

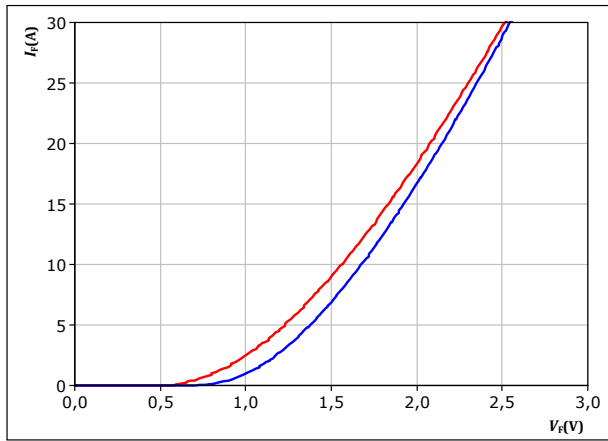

$t_p = 250 \mu s$
 $T_j: \text{ — } 25 \text{ }^\circ\text{C}$
 $\text{ — } 125 \text{ }^\circ\text{C}$

figure 10. FWD

Transient thermal impedance as a function of pulse width

$$Z_{th(j-s)} = f(t_p)$$

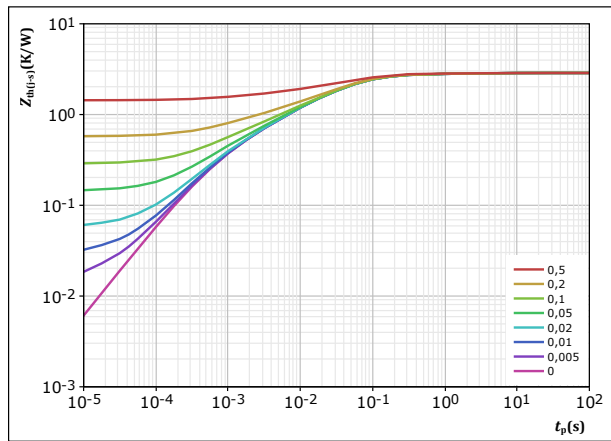

$D = t_p / T$
 $R_{th(j-s)} = 2,873 \text{ K/W}$
FWD thermal model values

R (K/W)	τ (s)
6,53E-02	3,94E+00
1,48E-01	4,48E-01
1,31E+00	5,96E-02
7,32E-01	1,36E-02
4,04E-01	2,79E-03
2,11E-01	5,37E-04



Current Transformer Protection Diode Characteristics

figure 11. FWD

Typical forward characteristics

$$I_F = f(V_F)$$

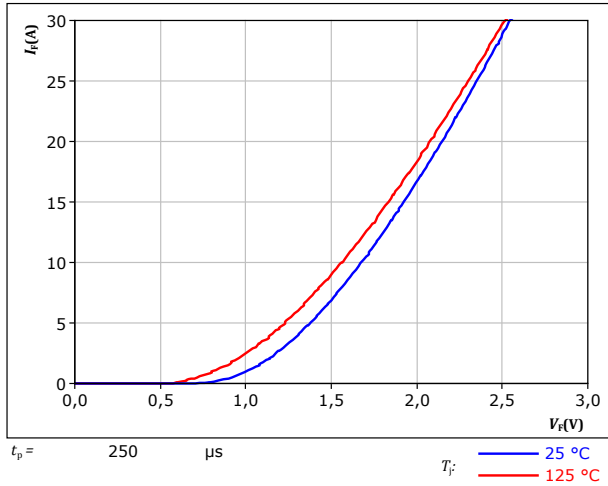
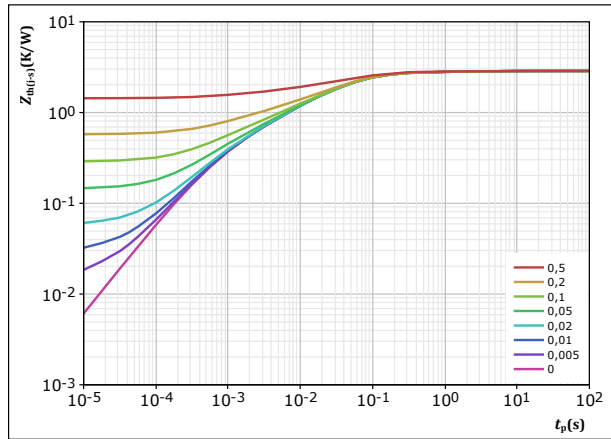

figure 12. FWD

Transient thermal impedance as a function of pulse width

$$Z_{th(j-s)} = f(t_p)$$



$D = \frac{t_p}{T}$

$R_{th(j-s)} = 2,873 \text{ K/W}$

FWD thermal model values

$R \text{ (K/W)}$	$\tau \text{ (s)}$
6,53E-02	3,94E+00
1,48E-01	4,48E-01
1,31E+00	5,96E-02
7,32E-01	1,36E-02
4,04E-01	2,79E-03
2,11E-01	5,37E-04



Shunt Protection Diode Characteristics

figure 13. Rectifier

Typical forward characteristics

$$I_F = f(V_F)$$

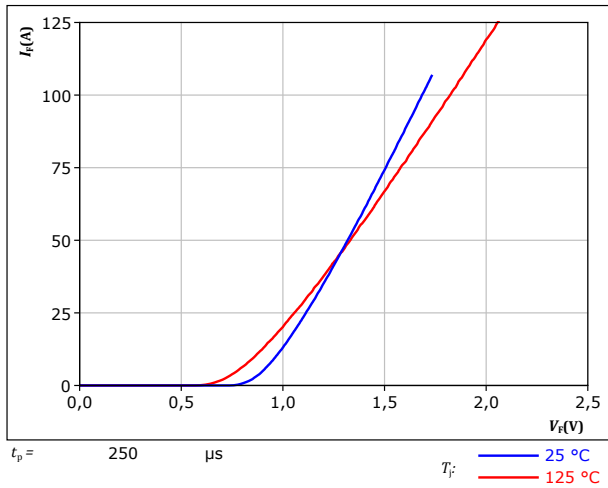
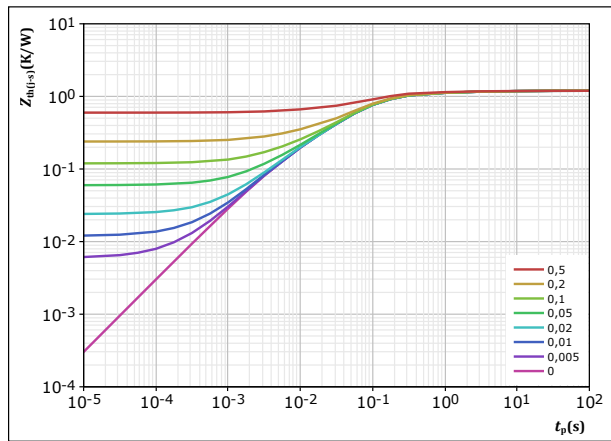

figure 14. Rectifier

Transient thermal impedance as a function of pulse width

$$Z_{th(j-s)} = f(t_p)$$



$D = t_p / T$

$R_{th(j-s)} = 1,195 \text{ K/W}$

Rectifier thermal model values

$R \text{ (K/W)}$	$\tau \text{ (s)}$
4,87E-02	6,80E+00
1,57E-01	6,29E-01
7,33E-01	9,05E-02
1,69E-01	3,10E-02
7,37E-02	4,76E-03
1,39E-02	1,53E-02



Rectifier Diode Characteristics

figure 15. Rectifier

Typical forward characteristics

$$I_F = f(V_F)$$

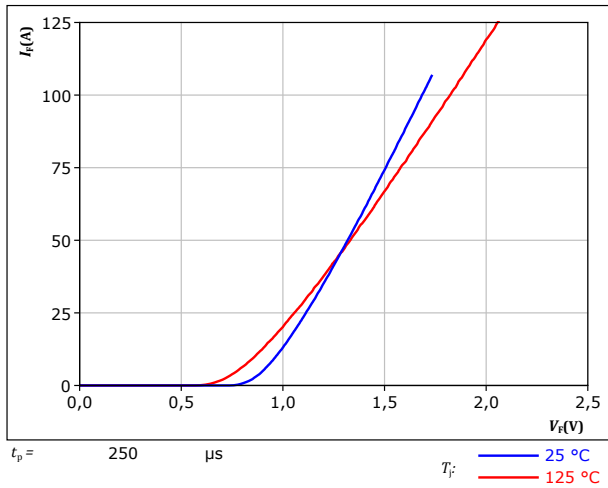
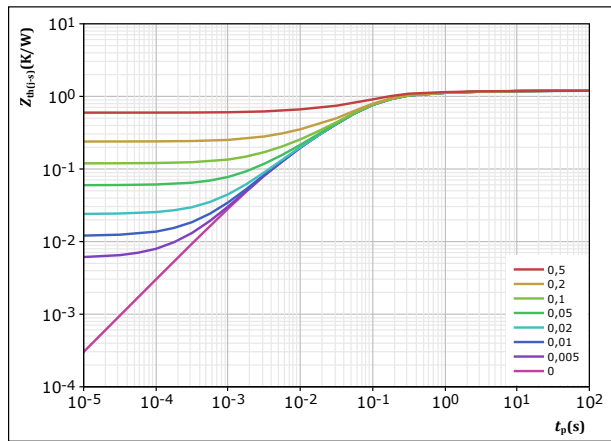

figure 16. Rectifier

Transient thermal impedance as a function of pulse width

$$Z_{th(j-s)} = f(t_p)$$



$D = t_p / T$

$R_{th(j-s)} = 1,195 \text{ K/W}$

Rectifier thermal model values

$R \text{ (K/W)}$	$\tau \text{ (s)}$
4,87E-02	6,80E+00
1,57E-01	6,29E-01
7,33E-01	9,05E-02
1,69E-01	3,10E-02
7,37E-02	4,76E-03
1,39E-02	1,53E-02



Thermistor Characteristics

figure 17. Thermistor

Typical NTC characteristic as function of temperature

$$R_T = f(T)$$

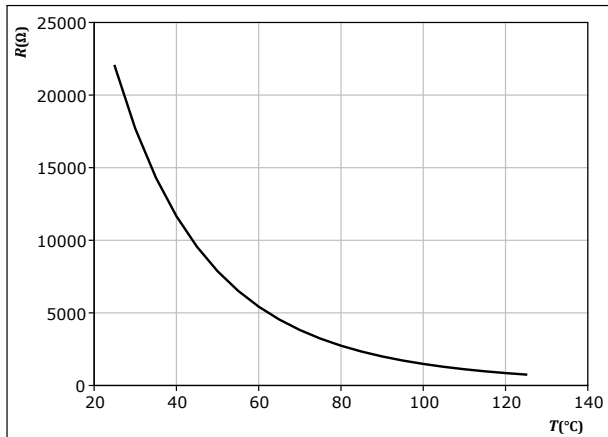



PFC Switching Characteristics

figure 18. IGBT

Typical switching energy losses as a function of collector current
 $E = f(I_c)$

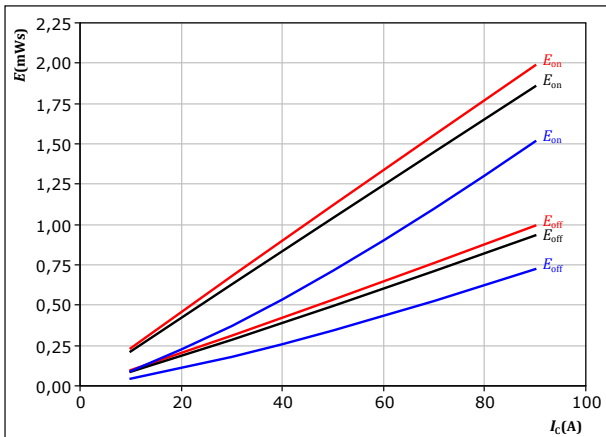

With an inductive load at

$V_{CE} = 400$ V	$T_j:$ 25 °C
$V_{GE} = 0/15$ V	125 °C
$R_{g(on)} = 8$ Ω	150 °C
$R_{g(off)} = 8$ Ω	

figure 19. IGBT

Typical switching energy losses as a function of IGBT turn on gate resistor
 $E = f(R_g)$

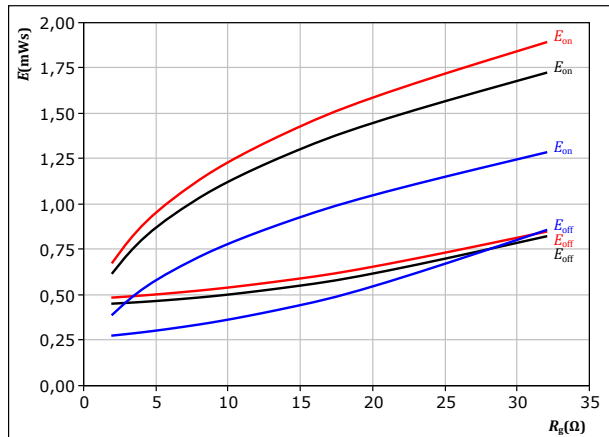

With an inductive load at

$V_{CE} = 400$ V	$T_j:$ 25 °C
$V_{GE} = 0/15$ V	125 °C
$I_c = 50$ A	150 °C

figure 20. FWD

Typical reverse recovered energy loss as a function of collector current
 $E_{rec} = f(I_c)$

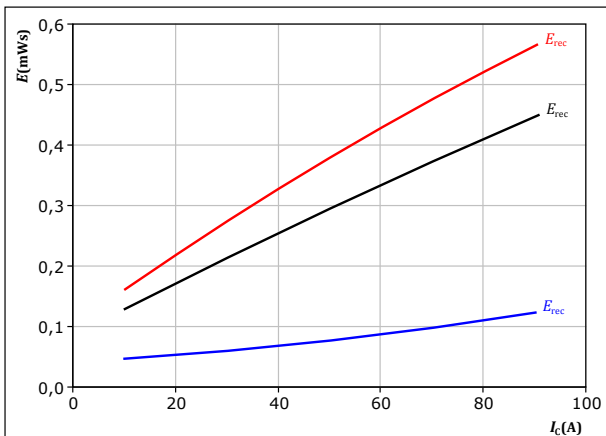

With an inductive load at

$V_{CE} = 400$ V	$T_j:$ 25 °C
$V_{GE} = 0/15$ V	125 °C
$R_{g(on)} = 8$ Ω	150 °C

figure 21. FWD

Typical reverse recovered energy loss as a function of IGBT turn on gate resistor
 $E_{rec} = f(R_g)$

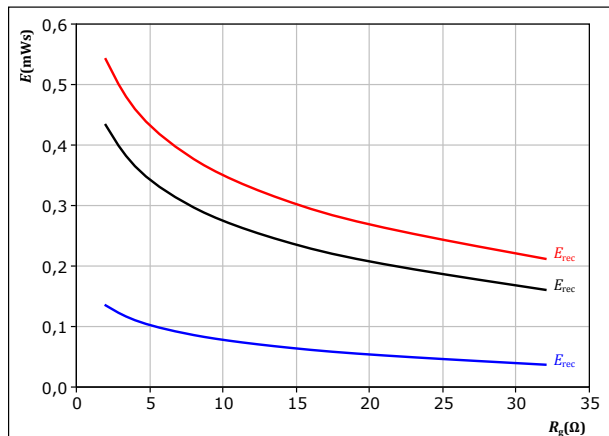

With an inductive load at

$V_{CE} = 400$ V	$T_j:$ 25 °C
$V_{GE} = 0/15$ V	125 °C
$I_c = 50$ A	150 °C



PFC Switching Characteristics

figure 22. IGBT

Typical switching times as a function of collector current
 $t = f(I_c)$

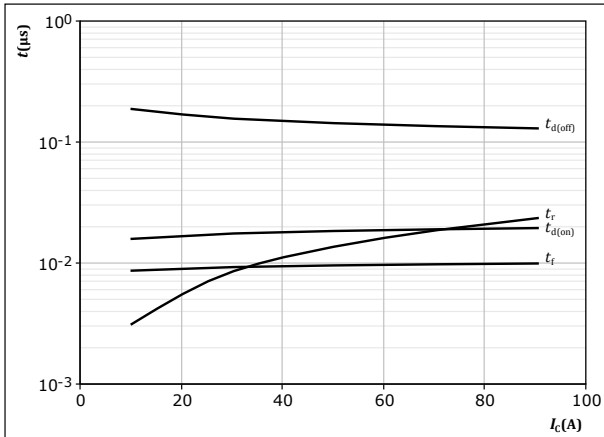

With an inductive load at
 $T_j = 150$ °C
 $V_{CE} = 400$ V
 $V_{GE} = 0/15$ V
 $R_{gon} = 8$ Ω
 $R_{goff} = 8$ Ω

figure 23. IGBT

Typical switching times as a function of IGBT turn on gate resistor
 $t = f(R_g)$

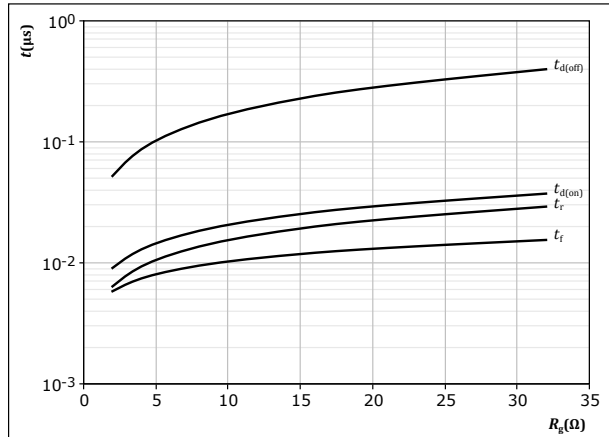

With an inductive load at
 $T_j = 150$ °C
 $V_{CE} = 400$ V
 $V_{GE} = 0/15$ V
 $I_c = 50$ A

figure 24. FWD

Typical reverse recovery time as a function of collector current
 $t_{rr} = f(I_c)$

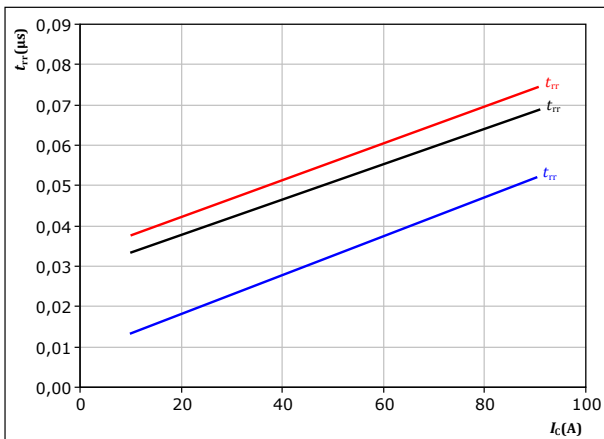

With an inductive load at
 $V_{CE} = 400$ V
 $V_{GE} = 0/15$ V
 $R_{gon} = 8$ Ω

T_j :
— 25 °C
— 125 °C
— 150 °C

figure 25. FWD

Typical reverse recovery time as a function of IGBT turn on gate resistor
 $t_{rr} = f(R_{gon})$

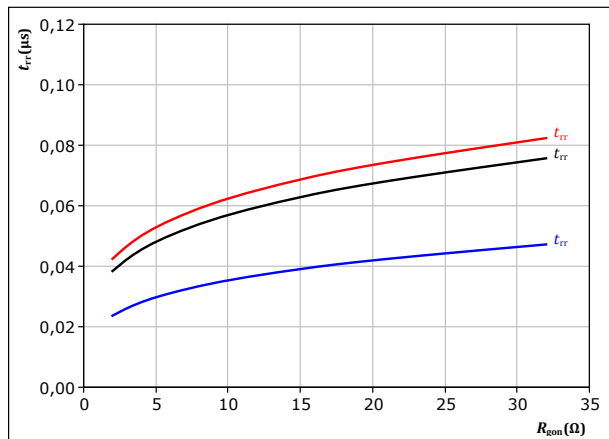

With an inductive load at
 $V_{CE} = 400$ V
 $V_{GE} = 0/15$ V
 $I_c = 50$ A

T_j :
— 25 °C
— 125 °C
— 150 °C



PFC Switching Characteristics

figure 26. FWD

Typical recovered charge as a function of collector current

$$Q_r = f(I_c)$$

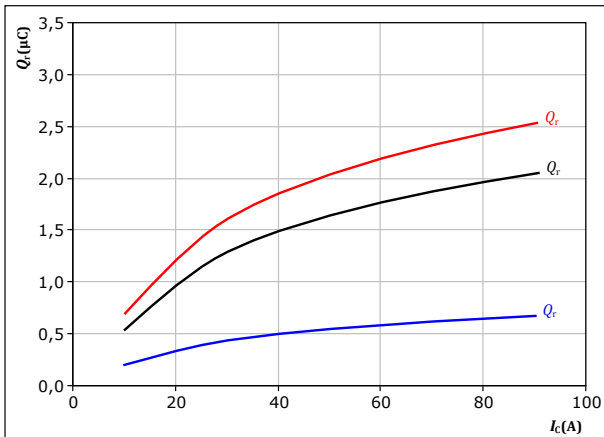

With an inductive load at

$V_{CE} = 400 \text{ V}$
 $V_{GE} = 0/15 \text{ V}$
 $R_{gon} = 8 \ \Omega$

T_j : — 25 °C
— 125 °C
— 150 °C

figure 27. FWD

Typical recovered charge as a function of IGBT turn on gate resistor

$$Q_r = f(R_{gon})$$

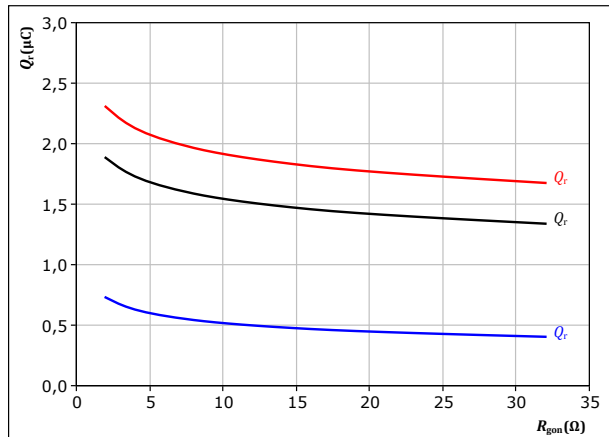

With an inductive load at

$V_{CE} = 400 \text{ V}$
 $V_{GE} = 0/15 \text{ V}$
 $I_c = 50 \text{ A}$

T_j : — 25 °C
— 125 °C
— 150 °C

figure 28. FWD

Typical peak reverse recovery current as a function of collector current

$$I_{RM} = f(I_c)$$

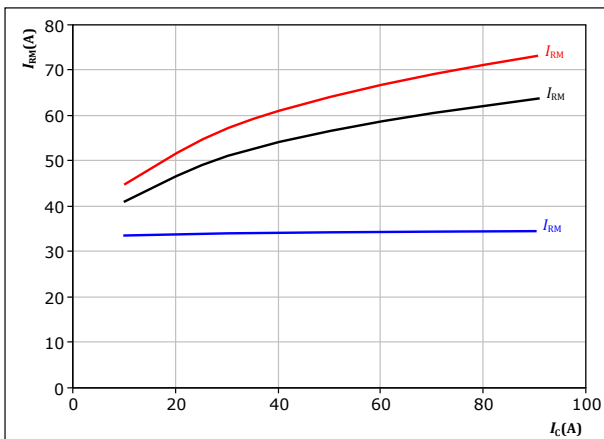

With an inductive load at

$V_{CE} = 400 \text{ V}$
 $V_{GE} = 0/15 \text{ V}$
 $R_{gon} = 8 \ \Omega$

T_j : — 25 °C
— 125 °C
— 150 °C

figure 29. FWD

Typical peak reverse recovery current as a function of IGBT turn on gate resistor

$$I_{RM} = f(R_{gon})$$

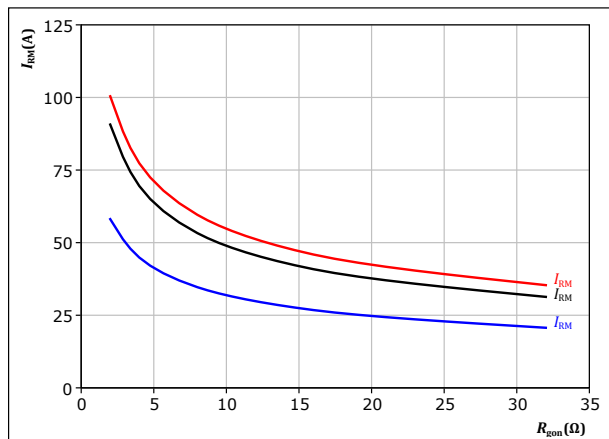

With an inductive load at

$V_{CE} = 400 \text{ V}$
 $V_{GE} = 0/15 \text{ V}$
 $I_c = 50 \text{ A}$

T_j : — 25 °C
— 125 °C
— 150 °C



PFC Switching Characteristics

figure 30. FWD

Typical rate of fall of forward and reverse recovery current as a function of collector current
 $di_i/dt, di_r/dt = f(I_c)$

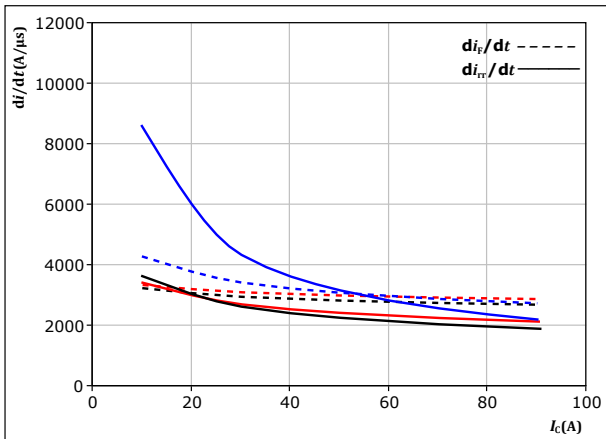

With an inductive load at

$V_{CE} = 400$ V
 $V_{GE} = 0/15$ V
 $R_{gon} = 8$ Ω

T_j :
— 25 °C
— 125 °C
— 150 °C

figure 31. FWD

Typical rate of fall of forward and reverse recovery current as a function of turn on gate resistor
 $di_i/dt, di_r/dt = f(R_{gon})$

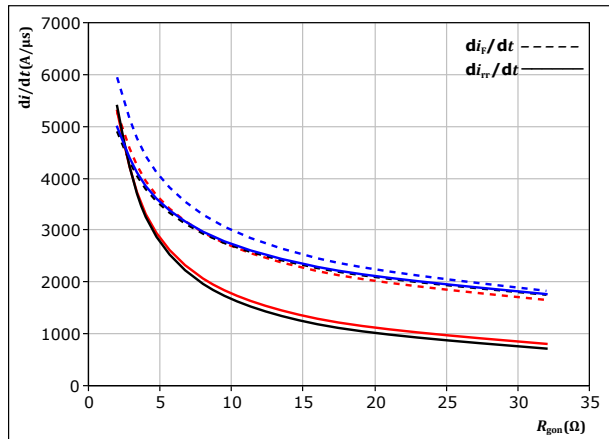

With an inductive load at

$V_{CE} = 400$ V
 $V_{GE} = 0/15$ V
 $I_c = 50$ A

T_j :
— 25 °C
— 125 °C
— 150 °C

figure 32. IGBT

Reverse bias safe operating area

$I_c = f(V_{CE})$

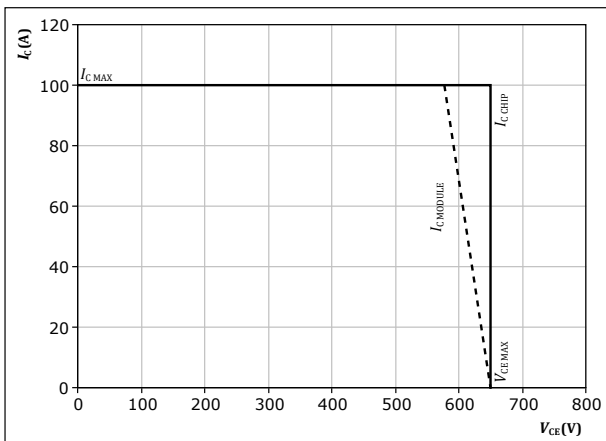

At $T_j = 150$ °C
 $R_{gon} = 8$ Ω
 $R_{goff} = 8$ Ω



PFC Switching Definitions

figure 33. IGBT

Turn-off Switching Waveforms & definition of t_{doff} , t_{Eoff} (t_{Eoff} = integrating time for E_{off})

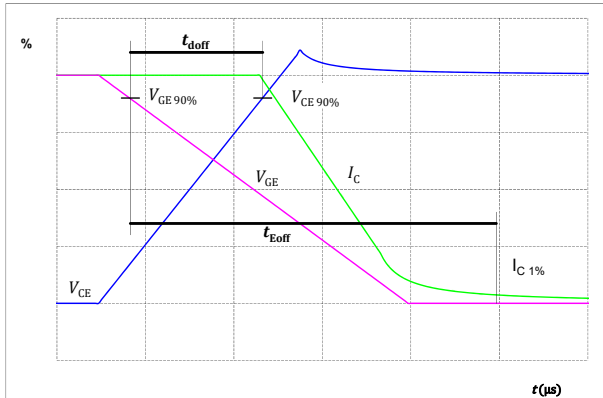

figure 34. IGBT

Turn-on Switching Waveforms & definition of t_{don} , t_{Eon} (t_{Eon} = integrating time for E_{on})

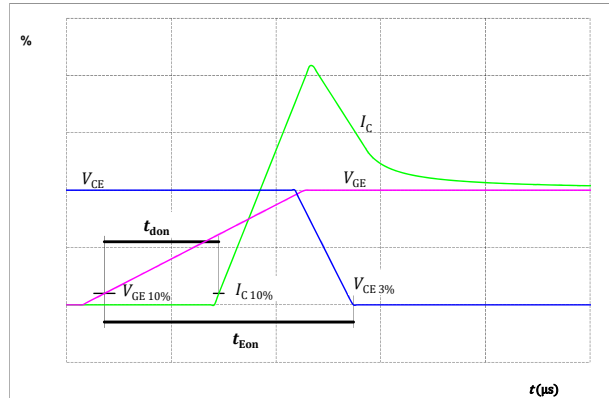

figure 35. IGBT

Turn-off Switching Waveforms & definition of t_f

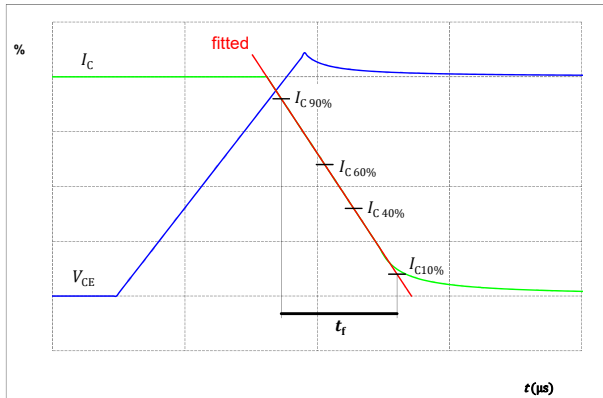
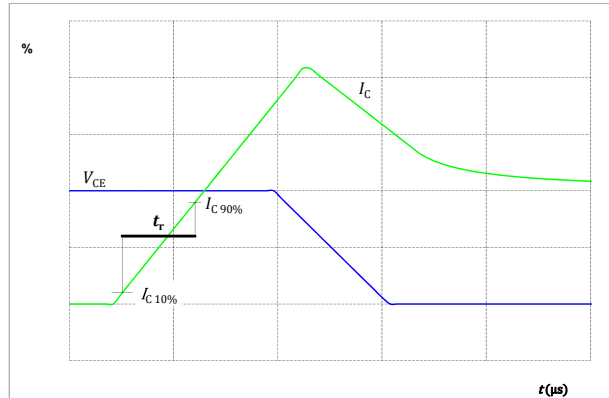

figure 36. IGBT

Turn-on Switching Waveforms & definition of t_r





PFC Switching Definitions

figure 37. FWD

Turn-off Switching Waveforms & definition of t_{rr}

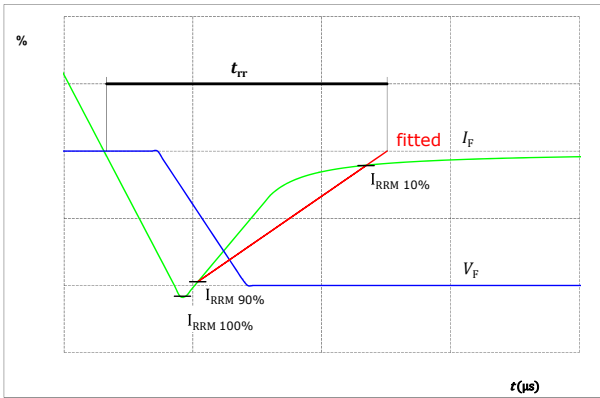
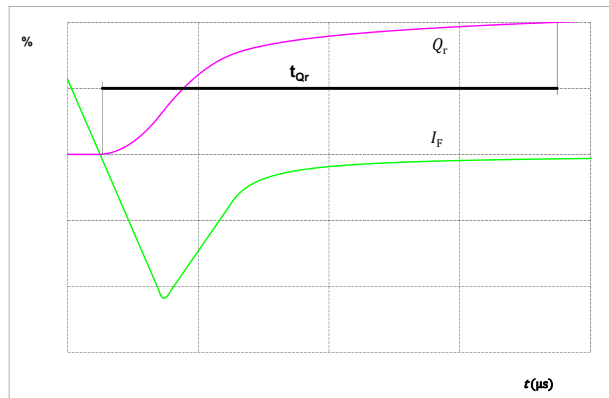

figure 38. FWD

Turn-on Switching Waveforms & definition of t_{Qr} (t_{Qr} = integrating time for Q_r)





Vincotech

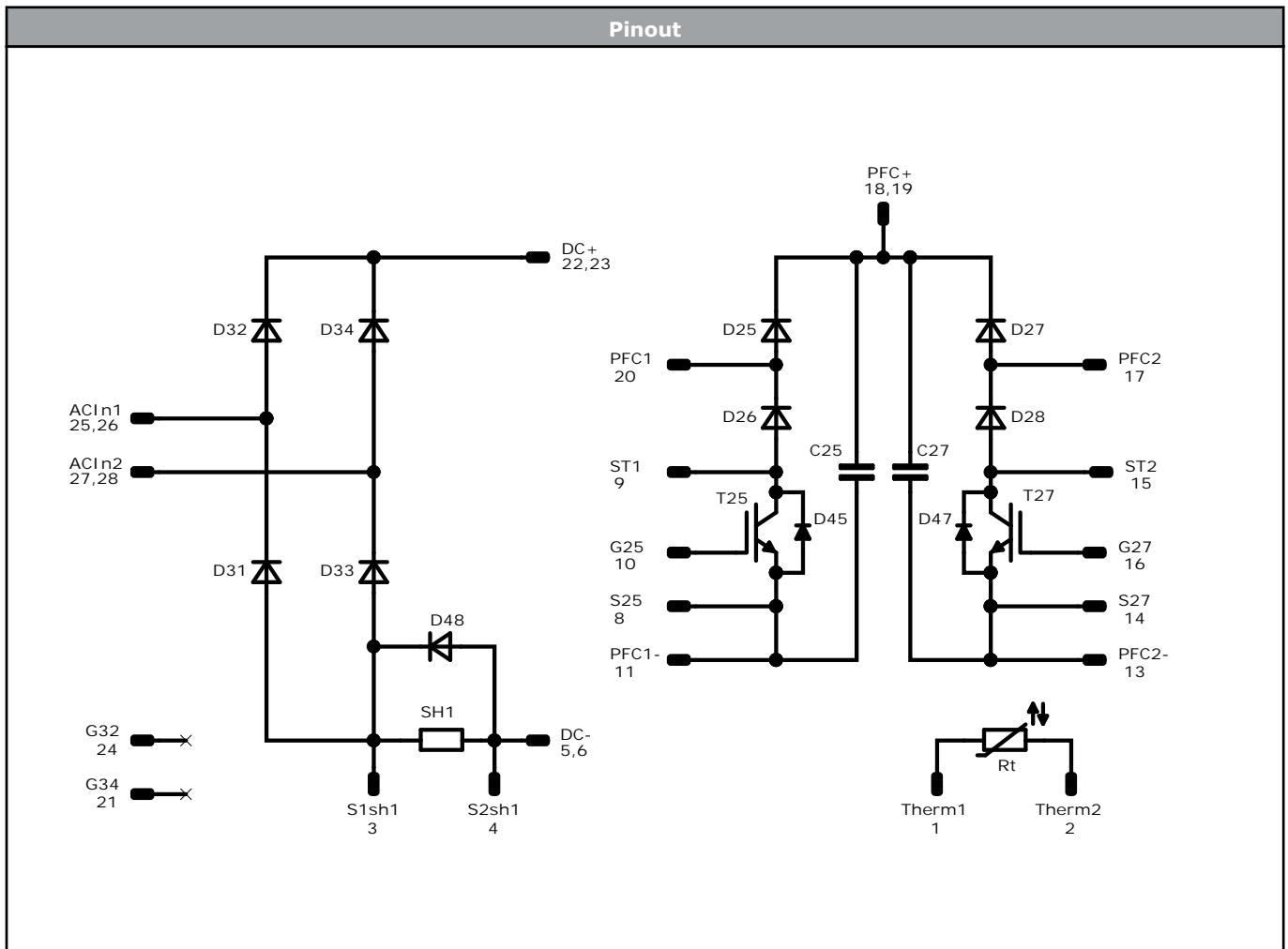

Identification					
ID	Component	Voltage	Current	Function	Comment
T25, T27	IGBT	650 V	50 A	PFC Switch	
D25, D27	FWD	600 V	30 A	PFC Diode	
D45, D47	FWD	650 V	10 A	PFC Sw. Protection Diode	
D26, D28	FWD	650 V	10 A	Current Transformer Protection Diode	
D48	Rectifier	1600 V	50 A	Shunt Protection Diode	
D31, D32, D33, D34	Rectifier	1600 V	50 A	Rectifier Diode	
SH1	Shunt			PFC Shunt	
C25, C27	Capacitor	1000 V		Capacitor (DC)	
Rt	Thermistor			Thermistor	



Packaging instruction				
Standard packaging quantity (SPQ) 135	>SPQ	Standard	<SPQ	Sample

Handling instruction
Handling instructions for <i>flow 0</i> packages see vincotech.com website.

Package data
Package data for <i>flow 0</i> packages see vincotech.com website.

Vincotech thermistor reference
See Vincotech thermistor reference table at vincotech.com website.

UL recognition and file number
This device is certified according to UL 1557 standard, UL file number E192116. For more information see vincotech.com website. 

Document No.:	Date:	Modification:	Pages
10-FZ062TA050SM-P987D13-D2-14	11 Jul. 2022	PFC Diode change	

DISCLAIMER

The information, specifications, procedures, methods and recommendations herein (together "information") are presented by Vincotech to reader in good faith, are believed to be accurate and reliable, but may well be incomplete and/or not applicable to all conditions or situations that may exist or occur. Vincotech reserves the right to make any changes without further notice to any products to improve reliability, function or design. No representation, guarantee or warranty is made to reader as to the accuracy, reliability or completeness of said information or that the application or use of any of the same will avoid hazards, accidents, losses, damages or injury of any kind to persons or property or that the same will not infringe third parties rights or give desired results. It is reader's sole responsibility to test and determine the suitability of the information and the product for reader's intended use.

LIFE SUPPORT POLICY

Vincotech products are not authorised for use as critical components in life support devices or systems without the express written approval of Vincotech.

As used herein:

1. Life support devices or systems are devices or systems which, (a) are intended for surgical implant into the body, or (b) support or sustain life, or (c) whose failure to perform when properly used in accordance with instructions for use provided in labelling can be reasonably expected to result in significant injury to the user.
2. A critical component is any component of a life support device or system whose failure to perform can be reasonably expected to cause the failure of the life support device or system, or to affect its safety or effectiveness.