

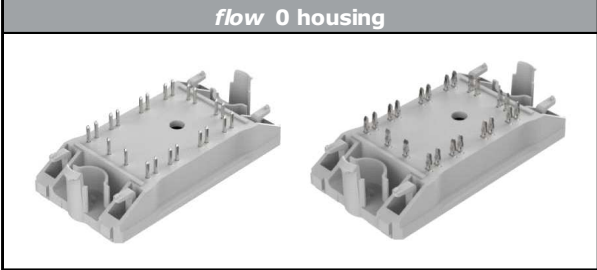
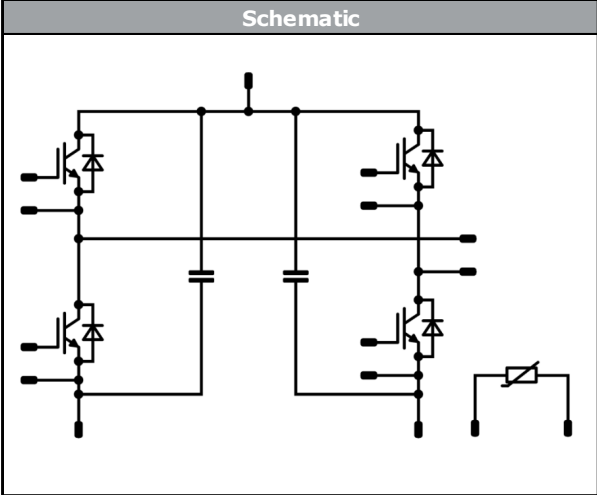

Vincotech

<i>fast</i> PACK 0 H C	650 V / 75 A
<div style="border: 1px solid black; padding: 5px; margin-bottom: 10px;"> <p style="text-align: center; background-color: #ccc; margin: 0;">Features</p> <ul style="list-style-type: none"> High speed H-Bridge High efficiency IGBT H5 Full current fast FWD Integrated capacitors Thermistor </div> <div style="border: 1px solid black; padding: 5px; margin-bottom: 10px;"> <p style="text-align: center; background-color: #ccc; margin: 0;">Target applications</p> <ul style="list-style-type: none"> Power Supply Solar Inverters UPS Welding & Cutting </div> <div style="border: 1px solid black; padding: 5px;"> <p style="text-align: center; background-color: #ccc; margin: 0;">Types</p> <ul style="list-style-type: none"> 10-FZ074PA075SM-L625F08 10-PZ074PA075SM-L625F08Y </div>	<div style="border: 1px solid black; padding: 5px; margin-bottom: 10px;"> <p style="text-align: center; background-color: #ccc; margin: 0;"><i>flow</i> 0 housing</p>  </div> <div style="border: 1px solid black; padding: 5px;"> <p style="text-align: center; background-color: #ccc; margin: 0;">Schematic</p>  </div>

Maximum Ratings

$T_j = 25\text{ °C}$, unless otherwise specified

Parameter	Symbol	Condition	Value	Unit
H-Bridge Switch				
Collector-emitter voltage	V_{CES}		650	V
Collector current	I_C	$T_j = T_{jmax}$ $T_s = 80\text{ °C}$	54	A
Repetitive peak collector current	I_{CRM}	t_p limited by T_{jmax}	225	A
Total power dissipation	P_{tot}	$T_j = T_{jmax}$ $T_s = 80\text{ °C}$	90	W
Gate-emitter voltage	V_{GES}		±20	V
Maximum Junction Temperature	T_{jmax}		175	°C



Vincotech

Maximum Ratings

$T_j = 25\text{ °C}$, unless otherwise specified

Parameter	Symbol	Condition	Value	Unit
-----------	--------	-----------	-------	------

H-Bridge Diode

Peak Repetitive Reverse Voltage	V_{RRM}		650	V
Continuous (direct) forward current	I_F	$T_j = T_{jmax}$ $T_s = 80\text{ °C}$	55	A
Repetitive peak forward current	I_{FRM}	T_j limited by T_{jmax}	150	A
Total power dissipation	P_{tot}	$T_j = T_{jmax}$ $T_s = 80\text{ °C}$	71	W
Maximum Junction Temperature	T_{jmax}		175	°C

Capacitor (DC)

Maximum DC voltage	V_{MAX}		630	V
Operation Temperature	T_{op}		-55...+125	°C

Module Properties

Thermal Properties

Storage temperature	T_{stg}		-40...+125	°C
Operation temperature under switching condition	T_{jop}		-40...($T_{jmax} - 25$)	°C

Isolation Properties

Isolation voltage	V_{isol}	DC Test Voltage* $t_p = 2\text{ s}$	6000	V
		AC Voltage $t_p = 1\text{ min}$	2500	V
Creepage distance			min. 12,7	mm
Clearance		with solder pins / with press-fit pins	9,55 / 9,15	mm
Comparative Tracking Index	CTI		> 200	

*100 % tested in production



Characteristic Values

Parameter	Symbol	Conditions					Value			Unit
		V_{GS} [V]	V_{GE} [V]	V_{DS} [V]	I_D [A]	T_j [°C]	Min	Typ	Max	

H-Bridge Switch

Static

Parameter	Symbol	$V_{GE} = V_{CE}$	V_{GS} [V]	V_{CE} [V]	I_C [A]	T_j [°C]	Min	Typ	Max	Unit
Gate-emitter threshold voltage	$V_{GE(th)}$				0,00075	25	3,3	4	4,7	V
Collector-emitter saturation voltage	V_{CEsat}		15		75	25 125 150		1,67 1,84 1,89	2,22	V
Collector-emitter cut-off current	I_{CES}		0	650		25			40	μA
Gate-emitter leakage current	I_{GES}		20	0		25			120	nA
Internal gate resistance	r_g							none		Ω
Input capacitance	C_{ies}							4300		pF
Output capacitance	C_{oes}	$f = 1$ MHz	0	25		25		75		
Reverse transfer capacitance	C_{res}							16		
Gate charge	Q_g		15	520	75	25		166		nC

Thermal

Parameter	Symbol	$\lambda_{paste} = 3,4$ W/mK (PSX)	V_{GS} [V]	V_{CE} [V]	I_D [A]	T_j [°C]	Min	Typ	Max	Unit
Thermal resistance junction to sink	$R_{th(j-s)}$							1,06		K/W

Dynamic

Parameter	Symbol	$R_{goff} = 2$ Ω $R_{gon} = 2$ Ω	V_{GS} [V]	V_{CE} [V]	I_D [A]	T_j [°C]	Min	Typ	Max	Unit	
Turn-on delay time	$t_{d(on)}$					25 125 150		49 49 49		ns	
Rise time	t_r					25 125 150		10 12 13			
Turn-off delay time	$t_{d(off)}$					25 125 150		67 79 82			
Fall time	t_f					25 125 150		5 7 9			
Turn-on energy (per pulse)	E_{on}	$Q_{t-FWD} = 2,5$ μC $Q_{t-FWD} = 4,5$ μC $Q_{t-FWD} = 5,2$ μC				25 125 150		0,644 0,982 1,08			mWs
Turn-off energy (per pulse)	E_{off}					25 125 150		0,269 0,524 0,596			



Characteristic Values

Parameter	Symbol	Conditions					Value			Unit
		V_{GE} [V] V_{GS} [V]	V_{CE} [V] V_{DS} [V]	I_C [A] I_D [A]	I_F [A]	T_j [°C]	Min	Typ	Max	

H-Bridge Diode

Static

Forward voltage	V_F				75	25 125 150		1,53 1,49 1,47	1,92	V
Reverse leakage current	I_r			650		25			3,8	μA

Thermal

Thermal resistance junction to sink	$R_{th(j-s)}$	$\lambda_{paste} = 3,4$ W/mK (PSX)						1,34		K/W
-------------------------------------	---------------	---------------------------------------	--	--	--	--	--	------	--	-----

Dynamic

Peak recovery current	I_{RRM}					25 125 150		90 111 117		A
Reverse recovery time	t_{rr}					25 125 150		51 83 93		ns
Recovered charge	Q_r	$di/dt = 7979$ A/μs $di/dt = 6480$ A/μs $di/dt = 6720$ A/μs	±15	350	75	25 125 150		2,53 4,54 5,21		μC
Reverse recovered energy	E_{rec}					25 125 150		0,578 1,07 1,24		mWs
Peak rate of fall of recovery current	$(di_{rr}/dt)_{max}$					25 125 150		3574 2005 2114		A/μs

Capacitor (DC)

Capacitance	C							150		nF
Tolerance							-10		+10	%
Dissipation factor		$f = 1$ kHz				25			2,5	%

Thermistor

Rated resistance	R					25		22		kΩ
Deviation of R_{100}	$\Delta_{R/R}$	$R_{100} = 1484$ Ω				100	-5		5	%
Power dissipation	P					25		5		mW
Power dissipation constant						25		1,5		mW/K
B-value	$B_{(25/50)}$	Tol. ±1 %				25		3962		K
B-value	$B_{(25/100)}$	Tol. ±1 %				25		4000		K
Vincotech NTC Reference									I	



H-Bridge Switch Characteristics

figure 1. IGBT

Typical output characteristics

$I_C = f(V_{CE})$

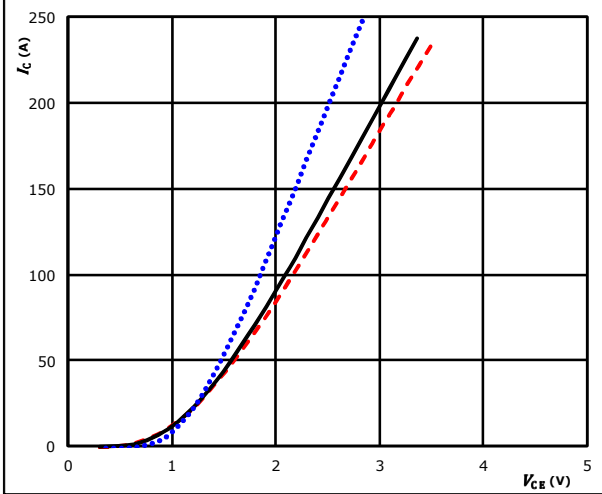

$t_p = 250 \mu s$
 $V_{GE} = 15 V$
 $T_j: 25 \text{ }^\circ C$ (dotted blue)
 $125 \text{ }^\circ C$ (solid black)
 $150 \text{ }^\circ C$ (dashed red)

figure 2. IGBT

Typical output characteristics

$I_C = f(V_{CE})$

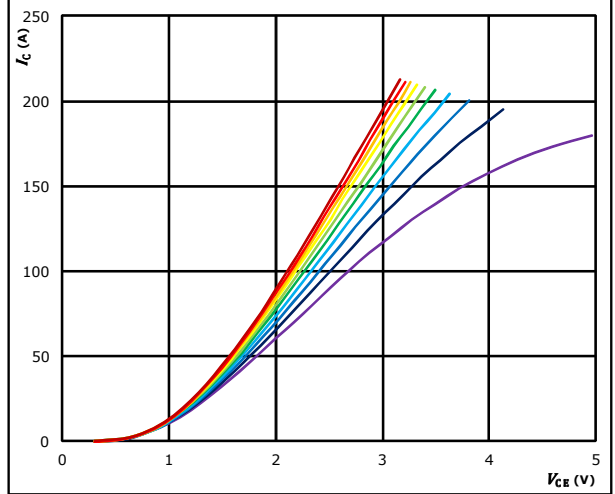

$t_p = 250 \mu s$
 $T_j = 150 \text{ }^\circ C$
 V_{GE} from 8 V to 17 V in steps of 1 V

figure 3. IGBT

Typical transfer characteristics

$I_C = f(V_{GE})$

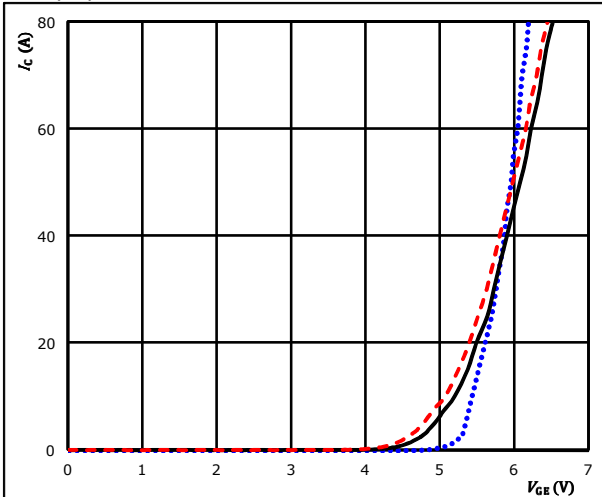

$t_p = 100 \mu s$
 $V_{CE} = 10 V$
 $T_j: 25 \text{ }^\circ C$ (dotted blue)
 $125 \text{ }^\circ C$ (solid black)
 $150 \text{ }^\circ C$ (dashed red)

figure 4. IGBT

Transient Thermal Impedance as function of Pulse duration

$Z_{th(j-s)} = f(t_p)$

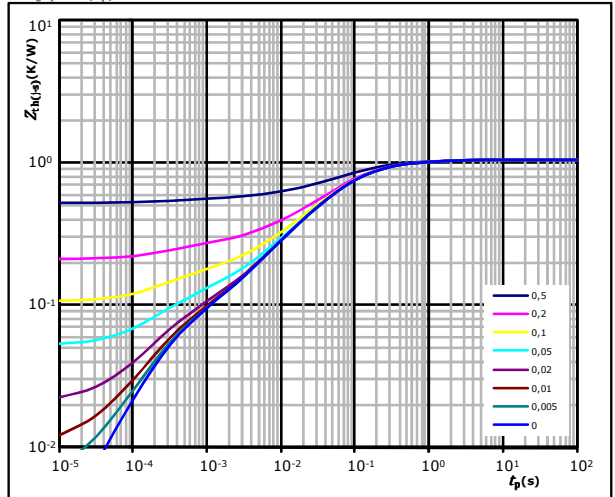

$D = t_p / T$
 $R_{th(j-s)} = 1,06 \text{ K/W}$
 IGBT thermal model values

R (K/W)	τ (s)
1,05E-01	8,62E-01
2,95E-01	1,39E-01
4,07E-01	4,84E-02
1,50E-01	1,04E-02
3,75E-02	2,37E-03
6,12E-02	2,88E-04



H-Bridge Switch Characteristics

figure 5. IGBT

Gate voltage vs Gate charge

$V_{GE} = f(Q_G)$

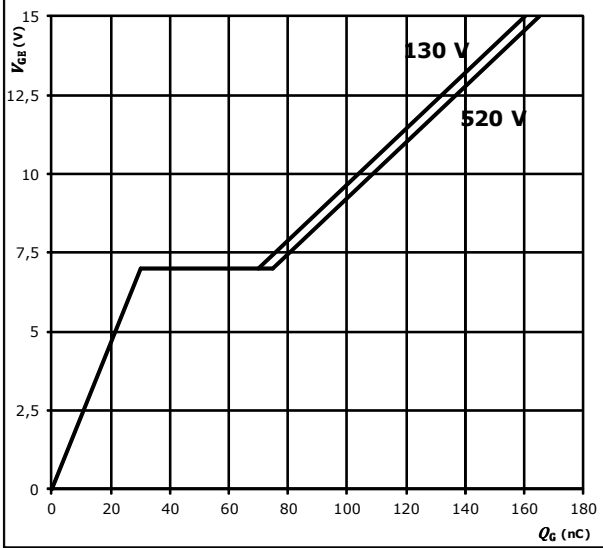

At

I_C = 75 A



H-Bridge Diode Characteristics

figure 1. FWD

Typical forward characteristics

$$I_F = f(V_F)$$

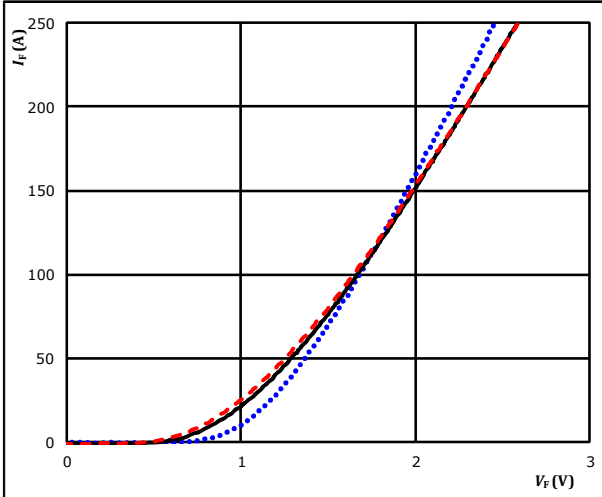

$t_p = 250 \mu s$
 T_j : 25 °C (blue dotted line)
 125 °C (black solid line)
 150 °C (red dashed line)

figure 2. FWD

Transient thermal impedance as a function of pulse width

$$Z_{th(j-s)} = f(t_p)$$

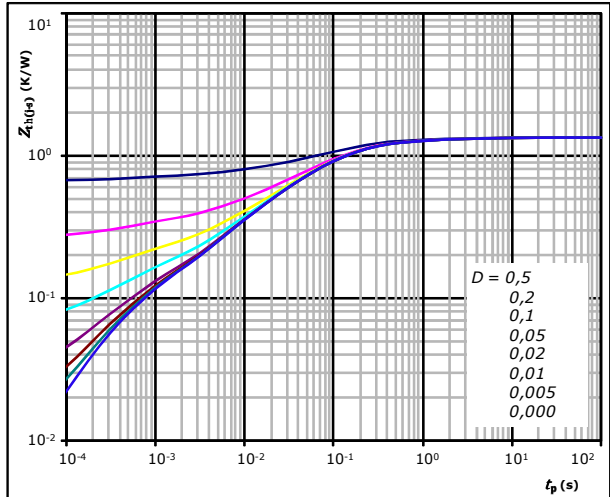

$D = t_p / T$
 $R_{th(j-s)} = 1,34 \text{ K/W}$

FWD thermal model values

R (K/W)	τ (s)
5,84E-02	3,64E+00
1,57E-01	5,25E-01
5,86E-01	1,06E-01
3,27E-01	2,57E-02
1,27E-01	4,84E-03
8,12E-02	4,11E-04

Thermistor Characteristics

figure 1. Thermistor

Typical NTC characteristic as a function of temperature

$$R = f(T)$$

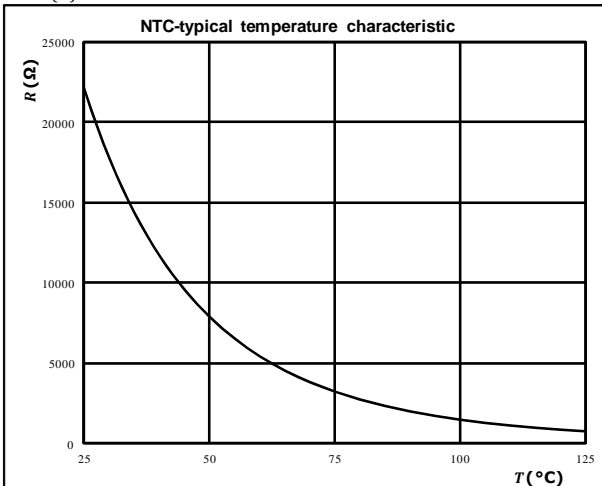



Switching Characteristics

figure 1. IGBT

Typical switching energy losses as a function of collector current

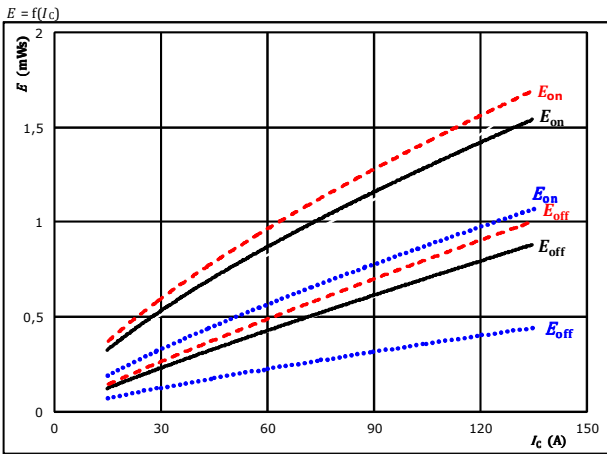

With an inductive load at
 $V_{CE} = 350$ V
 $V_{GE} = \pm 15$ V
 $R_{g\text{on}} = 2$ Ω
 $R_{g\text{off}} = 2$ Ω

T_j : 25 °C (dotted blue)
 125 °C (solid black)
 150 °C (dashed red)

figure 2. IGBT

Typical switching energy losses as a function of gate resistor

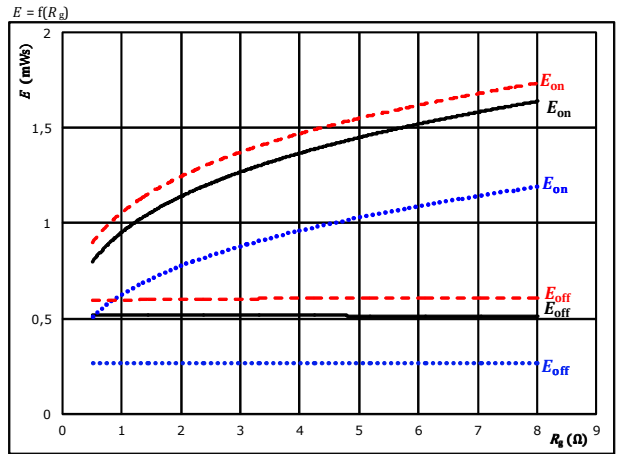

With an inductive load at
 $V_{CE} = 350$ V
 $V_{GE} = \pm 15$ V
 $I_C = 75$ A

T_j : 25 °C (dotted blue)
 125 °C (solid black)
 150 °C (dashed red)

figure 3. FWD

Typical reverse recovered energy loss as a function of collector current

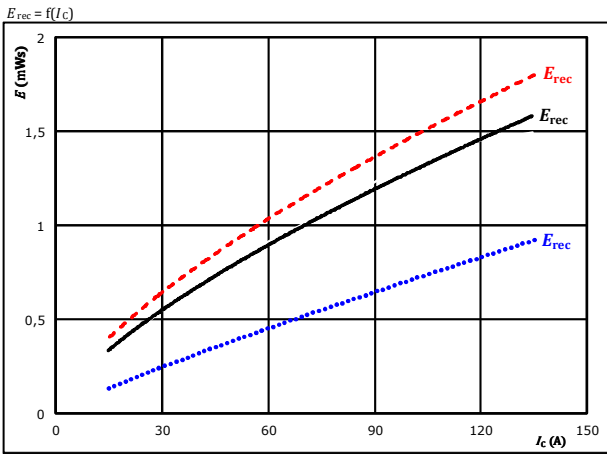

With an inductive load at
 $V_{CE} = 350$ V
 $V_{GE} = \pm 15$ V
 $R_{g\text{on}} = 2$ Ω

T_j : 25 °C (dotted blue)
 125 °C (solid black)
 150 °C (dashed red)

figure 4. FWD

Typical reverse recovered energy loss as a function of gate resistor

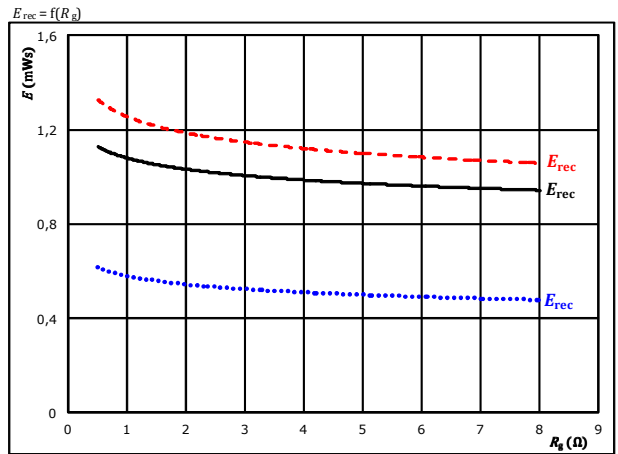

With an inductive load at
 $V_{CE} = 350$ V
 $V_{GE} = \pm 15$ V
 $I_C = 75$ A

T_j : 25 °C (dotted blue)
 125 °C (solid black)
 150 °C (dashed red)



Switching Characteristics

figure 5. IGBT

Typical switching times as a function of collector current

$$t = f(I_C)$$

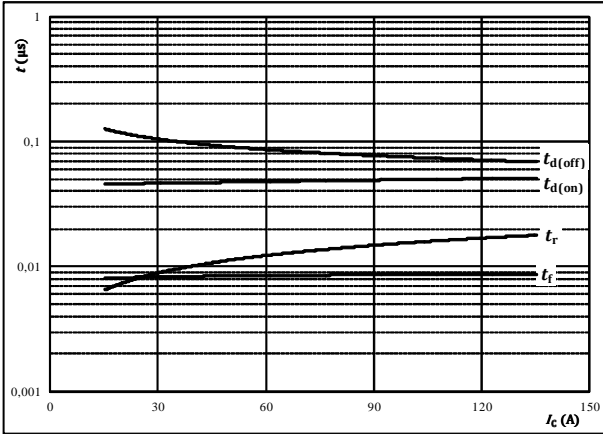

With an inductive load at

$T_j =$	150	°C
$V_{CE} =$	350	V
$V_{GE} =$	±15	V
$R_{gon} =$	2	Ω
$R_{goff} =$	2	Ω

figure 6. IGBT

Typical switching times as a function of gate resistor

$$t = f(R_g)$$

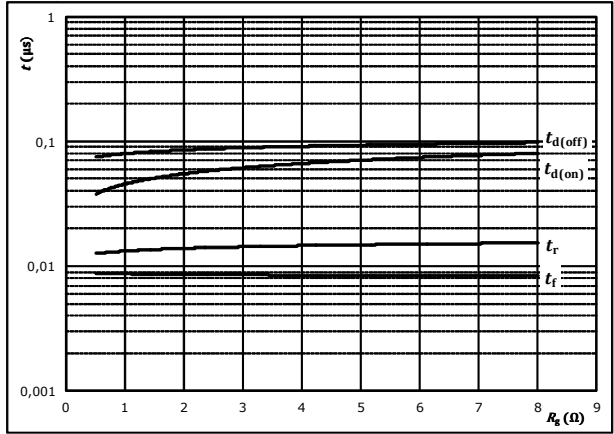

With an inductive load at

$T_j =$	150	°C
$V_{CE} =$	350	V
$V_{GE} =$	±15	V
$I_C =$	75	A

figure 7. FWD

Typical reverse recovery time as a function of collector current

$$t_{rr} = f(I_C)$$

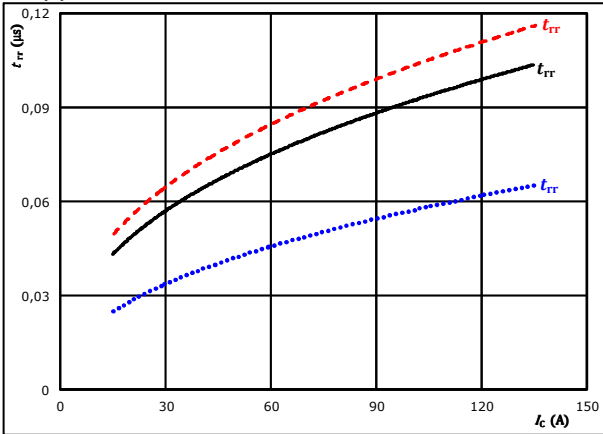

At	$V_{CE} =$	350	V	$T_j:$	25 °C
	$V_{GE} =$	±15	V		125 °C	————
	$R_{gon} =$	2	Ω		150 °C	- - - -

figure 8. FWD

Typical reverse recovery time as a function of IGBT turn on gate resistor

$$t_{rr} = f(R_{gon})$$

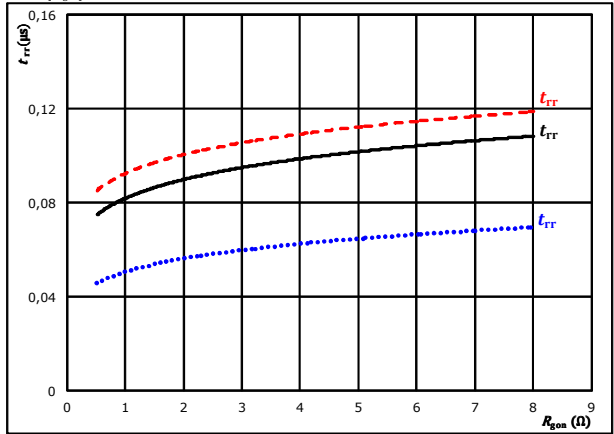

At	$V_{CE} =$	350	V	$T_j:$	25 °C
	$V_{GE} =$	±15	V		125 °C	————
	$I_C =$	75	A		150 °C	- - - -



Switching Characteristics

figure 9. FWD

Typical recovered charge as a function of collector current

$$Q_r = f(I_c)$$

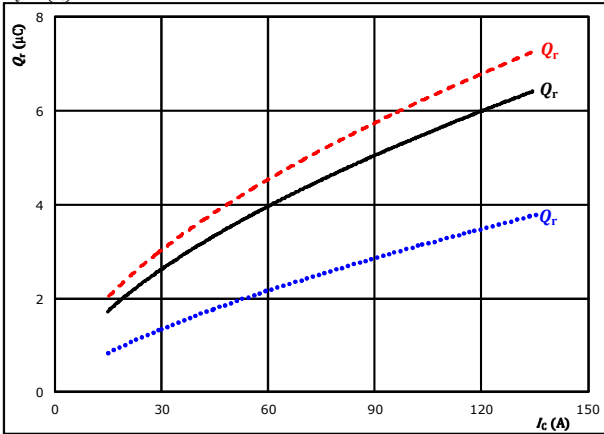

At $V_{CE} = 350$ V $T_j = 25$ °C
 $V_{GE} = \pm 15$ V $T_j = 125$ °C ———
 $R_{gdn} = 2$ Ω $T_j = 150$ °C - - - - -

figure 10. FWD

Typical recovered charge as a function of IGBT turn on gate resistor

$$Q_r = f(R_{gdn})$$

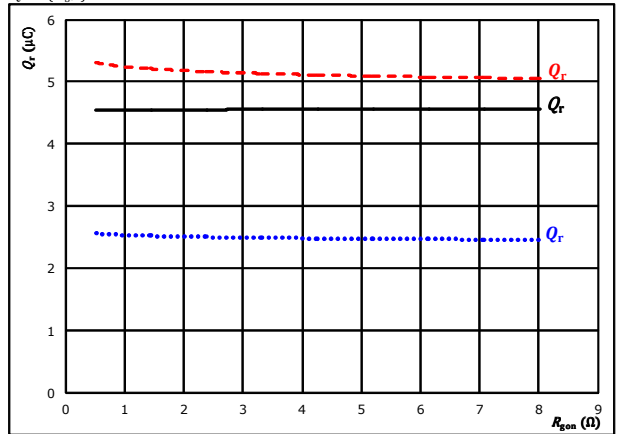

At $V_{CE} = 350$ V $T_j = 25$ °C
 $V_{GE} = \pm 15$ V $T_j = 125$ °C ———
 $I_c = 75$ A $T_j = 150$ °C - - - - -

figure 11. FWD

Typical peak reverse recovery current current as a function of collector current

$$I_{RM} = f(I_c)$$

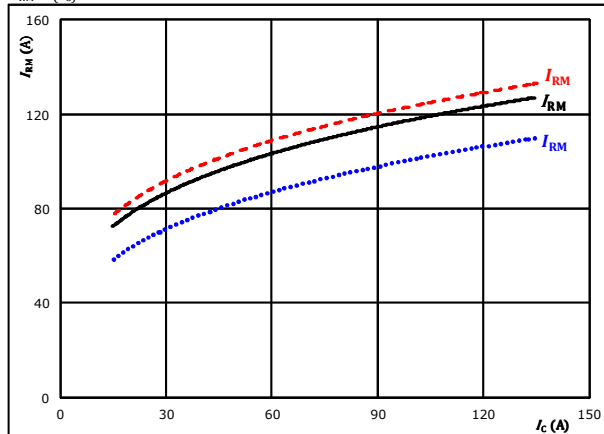

At $V_{CE} = 350$ V $T_j = 25$ °C
 $V_{GE} = \pm 15$ V $T_j = 125$ °C ———
 $R_{gdn} = 2$ Ω $T_j = 150$ °C - - - - -

figure 12. FWD

Typical peak reverse recovery current as a function of IGBT turn on gate resistor

$$I_{RM} = f(R_{gdn})$$

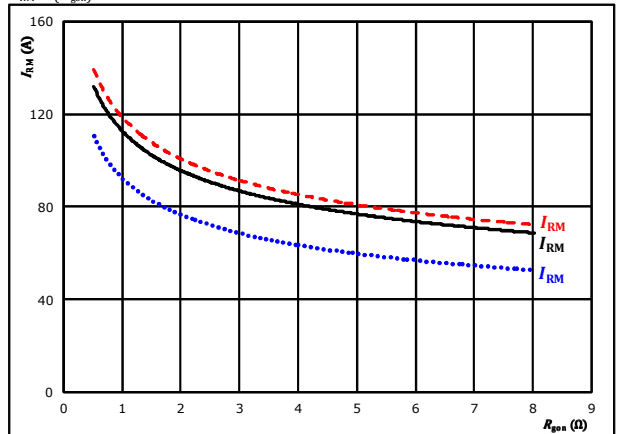

At $V_{CE} = 350$ V $T_j = 25$ °C
 $V_{GE} = \pm 15$ V $T_j = 125$ °C ———
 $I_c = 75$ A $T_j = 150$ °C - - - - -



Switching Characteristics

figure 13. FWD

Typical rate of fall of forward and reverse recovery current as a function of collector current
 $di_f/dt, di_{rr}/dt = f(I_c)$

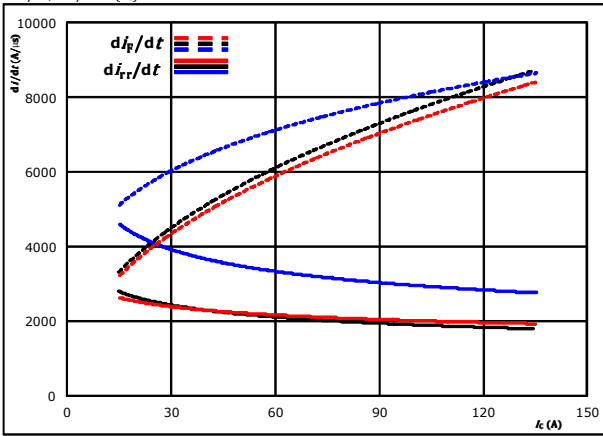

At $V_{CE} = 350$ V $T_j = 25$ °C (.....)
 $V_{GE} = \pm 15$ V $T_j = 125$ °C (—)
 $R_{g\text{on}} = 2$ Ω $T_j = 150$ °C (---)

figure 14. FWD

Typical rate of fall of forward and reverse recovery current as a function of IGBT turn on gate resistor
 $di_f/dt, di_{rr}/dt = f(R_{g\text{on}})$

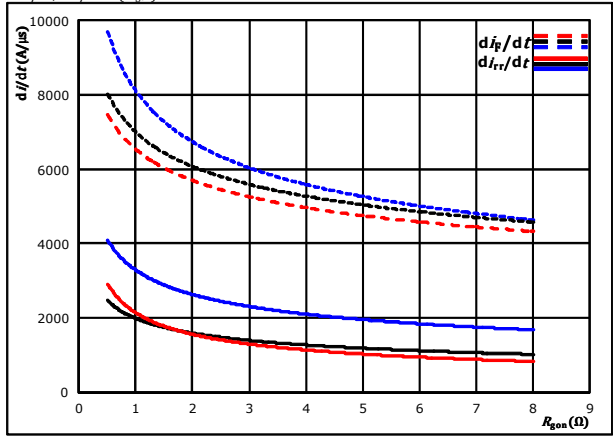

At $V_{CE} = 350$ V $T_j = 25$ °C (.....)
 $V_{GE} = \pm 15$ V $T_j = 125$ °C (—)
 $I_c = 75$ A $T_j = 150$ °C (---)

figure 15. IGBT

Reverse bias safe operating area
 $I_c = f(V_{CE})$

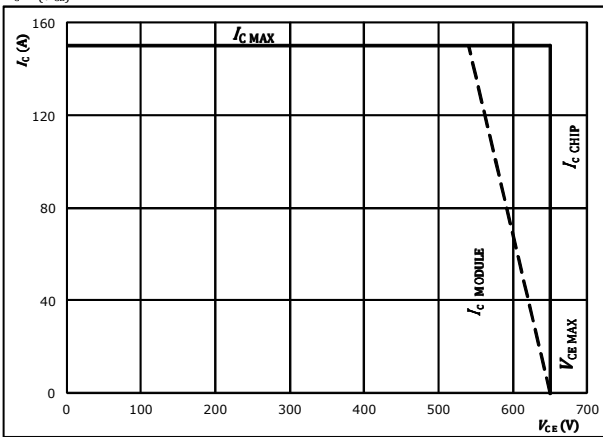

At $T_j = 175$ °C
 $R_{g\text{on}} = 2$ Ω
 $R_{g\text{off}} = 2$ Ω



Switching Definitions

General conditions

T_j	=	125 °C
R_{gon}	=	2 Ω
R_{goff}	=	2 Ω

figure 1. IGBT

Turn-off Switching Waveforms & definition of t_{doff} , t_{Eoff} (t_{Eoff} = integrating time for E_{off})

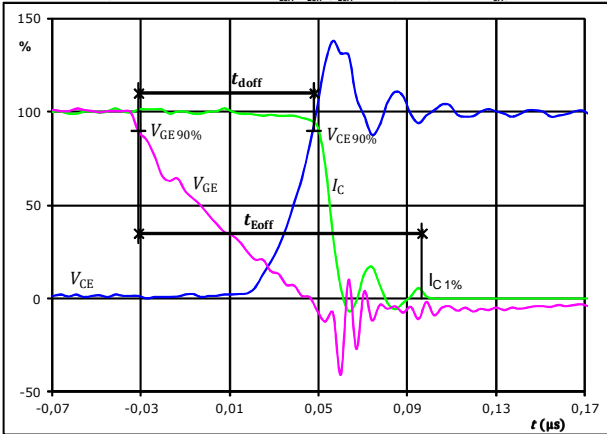

$V_{CE}(0\%) =$	-15	V
$V_{GE}(100\%) =$	15	V
$V_C(100\%) =$	350	V
$I_C(100\%) =$	76	A
$t_{doff} =$	0,079	μs
$t_{Eoff} =$	0,127	μs

figure 2. IGBT

Turn-on Switching Waveforms & definition of t_{don} , t_{Eon} (t_{Eon} = integrating time for E_{on})

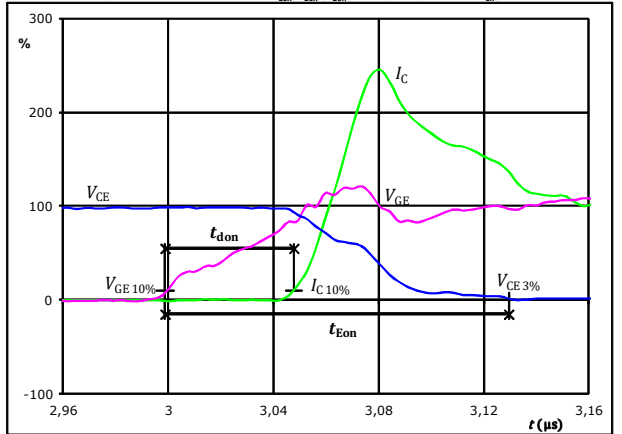

$V_{CE}(0\%) =$	-15	V
$V_{GE}(100\%) =$	15	V
$V_C(100\%) =$	350	V
$I_C(100\%) =$	76	A
$t_{don} =$	0,049	μs
$t_{Eon} =$	0,131	μs

figure 3. IGBT

Turn-off Switching Waveforms & definition of t_r

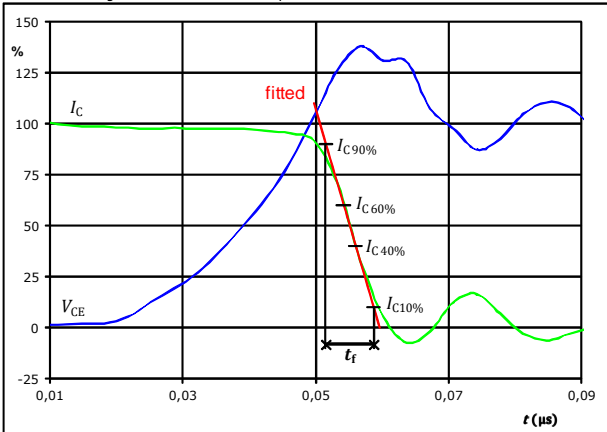

$V_C(100\%) =$	350	V
$I_C(100\%) =$	76	A
$t_r =$	0,007	μs

figure 4. IGBT

Turn-on Switching Waveforms & definition of t_r

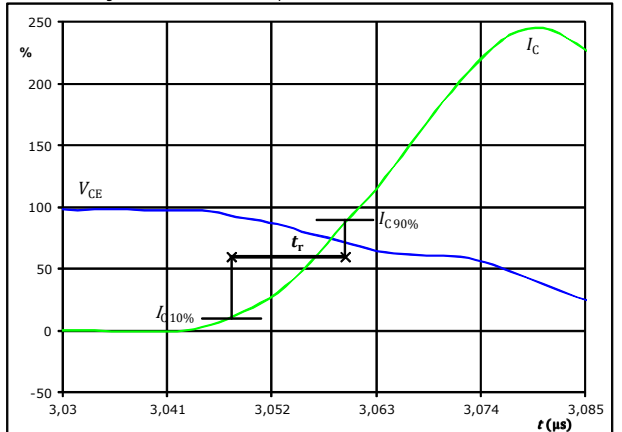

$V_C(100\%) =$	350	V
$I_C(100\%) =$	76	A
$t_r =$	0,012	μs



Vincotech

Switching Characteristics

figure 5. IGBT

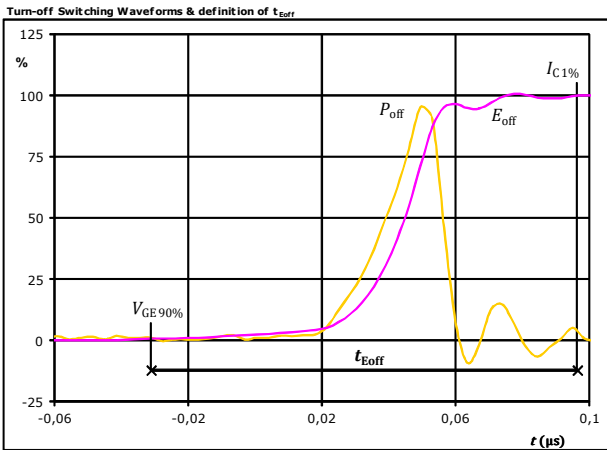

$P_{off}(100\%) = 26,61$ kW
 $E_{off}(100\%) = 0,52$ mJ
 $t_{Eoff} = 0,13$ µs

figure 6. IGBT

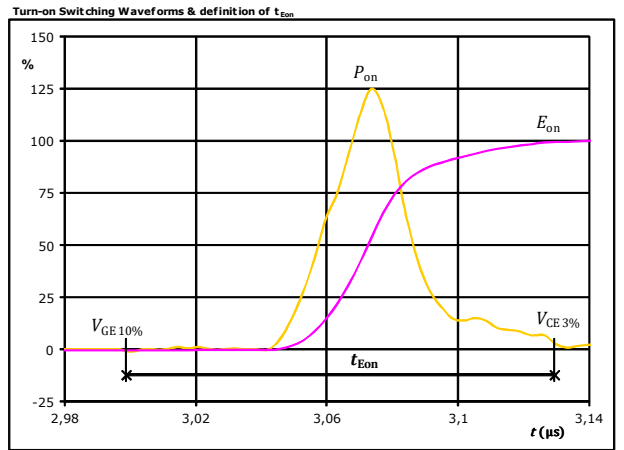

$P_{on}(100\%) = 26,61$ kW
 $E_{on}(100\%) = 0,98$ mJ
 $t_{Eon} = 0,13$ µs

figure 7. FWD

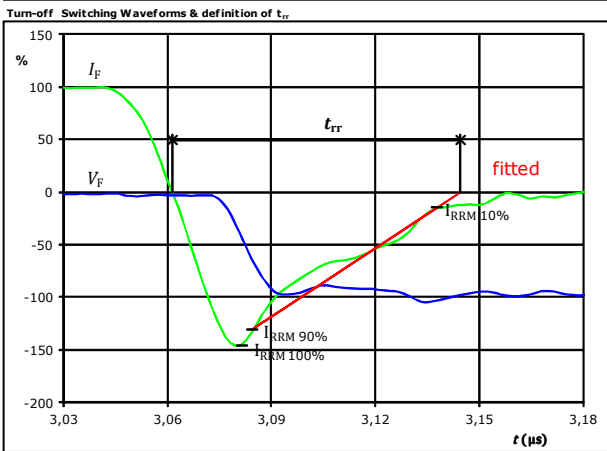

$V_F(100\%) = 350$ V
 $I_F(100\%) = 76$ A
 $I_{RRM}(100\%) = -111$ A
 $t_{rr} = 0,083$ µs



Switching Characteristics

figure 8. FWD

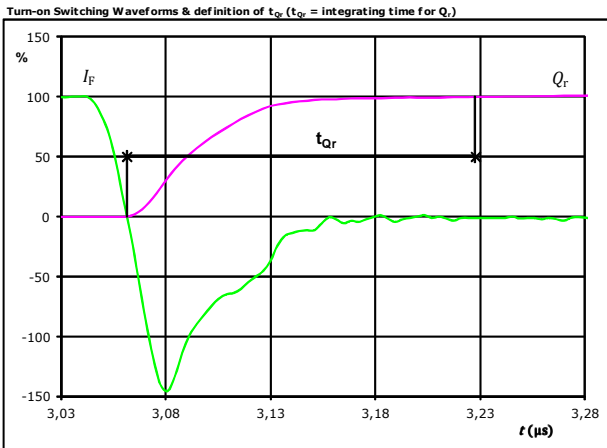

I_F (100%) =	76	A
Q_r (100%) =	4,54	μC
t_{Qr} =	0,17	μs

figure 9. FWD

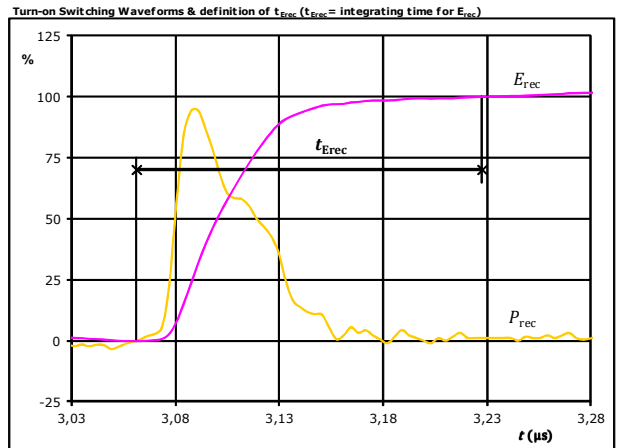

P_{rec} (100%) =	26,61	kW
E_{rec} (100%) =	1,07	mJ
t_{Erec} =	0,17	μs



10-FZ074PA075SM-L625F08
10-PZ074PA075SM-L625F08Y
 datasheet

Vincotech

Ordering Code & Marking						
Version			Ordering Code			
without thermal paste 12 mm housing with solder pins			10-FZ074PA075SM-L625F08			
without thermal paste 12 mm housing with press-fit pins			10-PZ074PA075SM-L625F08Y			
NN-NNNNNNNNNNNN TTTTUV WWYY UL VIN LLLL SSSS						
Text	Name		Date code	UL & VIN	Lot	Serial
	NN-NNNNNNNNNNNN-TTTTUV		WWYY	UL VIN	LLLL	SSSS
Datamatrix	Type&Ver	Lot number	Serial	Date code		
	TTTTTUV	LLLL	SSSS	WWYY		

Pin table [mm]			
Pin	X	Y	Function
1	0	22,5	G11
2	2,9	22,5	S11
3	8,3	22,5	DC-1
4	10,8	22,5	DC-1
5	19,6	22,5	DC+
6	22,1	22,5	DC+
7	29,1	22,5	S12
8	32	22,5	G12
9	33,5	17,8	Ph1
10	33,5	15,3	Ph1
11	33,5	7,2	Ph2
12	33,5	4,7	Ph2
13	32	0	G14
14	29,1	0	S14
15	22,1	0	DC+
16	19,6	0	DC+
17	10,8	0	DC-2
18	8,3	0	DC-2
19	2,9	0	S13
20	0	0	G13
21	0	8	Therm1
22	0	14,5	Therm2

Outline

Tolerance of pinpositions: ±0.5mm at the end of pins
 Dimension of coordinate axis is only offset without tolerance

Tolerance of pinpositions: ±0.5mm at the end of pins
 Dimension of coordinate axis is only offset without tolerance



Vincotech

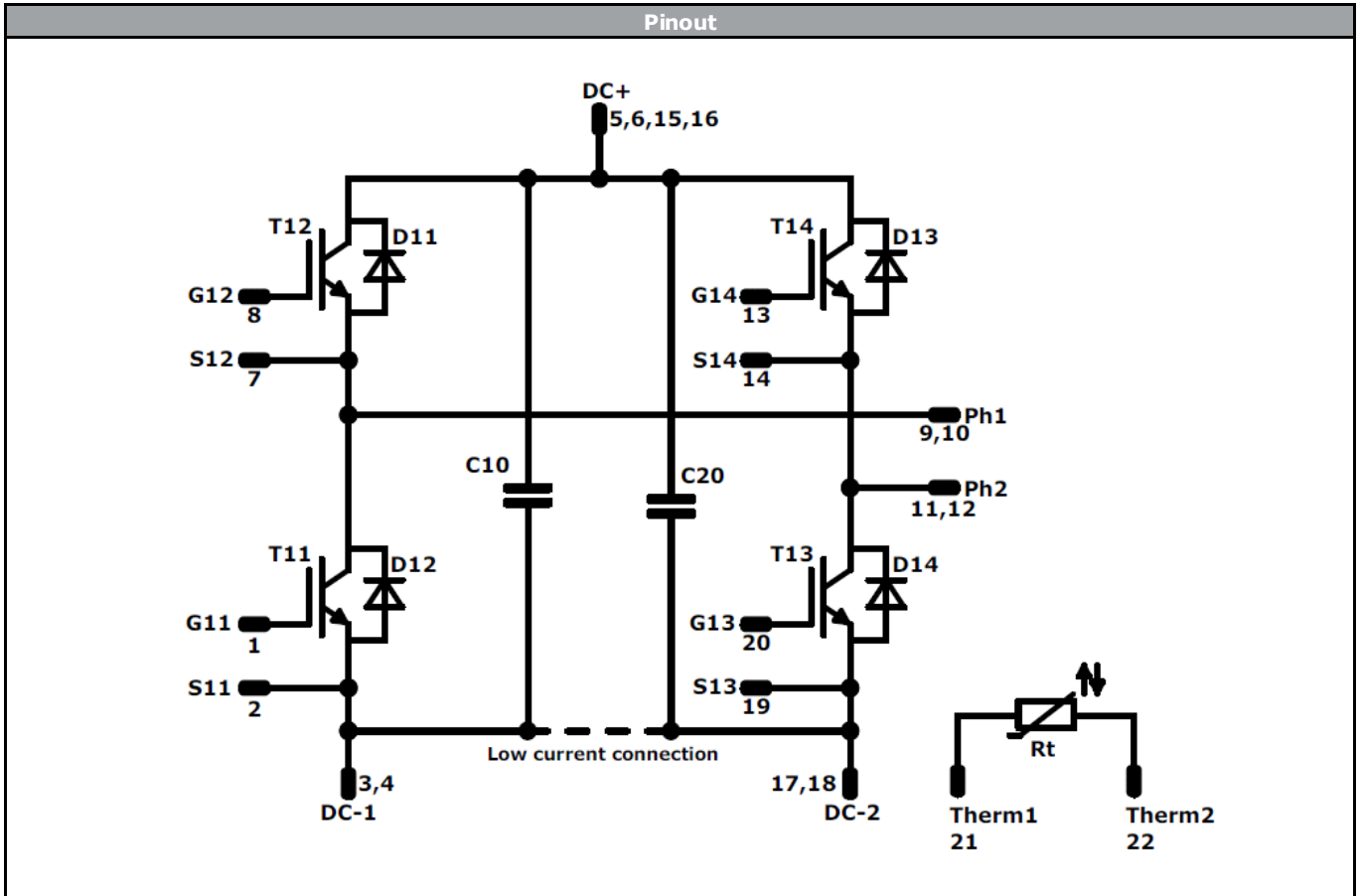

Identification					
ID	Component	Voltage	Current	Function	Comment
T11-T14	IGBT	650 V	75 A	H-Bridge Switch	
D11-D14	FWD	650 V	75 A	H-Bridge Diode	
C10, C20	Capacitor	630 V		Capacitor (DC)	
Rt	NTC			Thermistor	



Vincotech

Packaging instruction			
Standard packaging quantity (SPQ) 135	>SPQ	Standard	<SPQ Sample

Handling instruction
Handling instructions for <i>flow 0</i> packages see vincotech.com website.

Package data
Package data for <i>flow 0</i> packages see vincotech.com website.

UL recognition and file number
This device is certified according to UL 1557 standard, UL file number E192116. For more information see vincotech.com website. 

Document No.:	Date:	Modification:	Pages
10-xZ074PA075SM-L625F08x-D2-14	18 Oct. 2017		

DISCLAIMER

The information, specifications, procedures, methods and recommendations herein (together "information") are presented by Vincotech to reader in good faith, are believed to be accurate and reliable, but may well be incomplete and/or not applicable to all conditions or situations that may exist or occur. Vincotech reserves the right to make any changes without further notice to any products to improve reliability, function or design. No representation, guarantee or warranty is made to reader as to the accuracy, reliability or completeness of said information or that the application or use of any of the same will avoid hazards, accidents, losses, damages or injury of any kind to persons or property or that the same will not infringe third parties rights or give desired results. It is reader's sole responsibility to test and determine the suitability of the information and the product for reader's intended use.

LIFE SUPPORT POLICY

Vincotech products are not authorised for use as critical components in life support devices or systems without the express written approval of Vincotech.

As used herein:

1. Life support devices or systems are devices or systems which, (a) are intended for surgical implant into the body, or (b) support or sustain life, or (c) whose failure to perform when properly used in accordance with instructions for use provided in labelling can be reasonably expected to result in significant injury to the user.
2. A critical component is any component of a life support device or system whose failure to perform can be reasonably expected to cause the failure of the life support device or system, or to affect its safety or effectiveness.