



flowANPFC 0

650 V / 100 A

Topology features

- Advanced Neutral Boost PFC
- Integrated DC capacitor
- Kelvin Emitter for improved switching performance
- Temperature sensor

Component features

- High efficiency in hard switching and resonant topologies
- High speed switching
- Low gate charge

Housing features

- Base isolation: Al₂O₃
- Clip-in, reliable mechanical connection, qualified for wave soldering
- Convex shaped substrate for superior thermal contact
- Thermo-mechanical push-and-pull force relief
- Press-fit pin
- Reliable cold welding connection

Target applications

- Charging Stations
- Power Supply
- UPS

Types

- 10-PZ07ANA100RG03-LK39L38Y

flow 0 12 mm housing

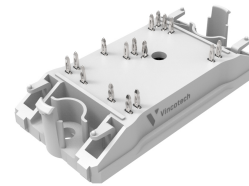

Schematic

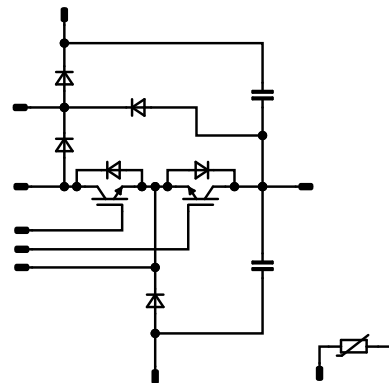



Vincotech

Maximum Ratings

$T_j = 25\text{ °C}$, unless otherwise specified

Parameter	Symbol	Conditions	Value	Unit
Negative Neutral Point Switch				
Collector-emitter voltage	V_{CES}		650	V
Collector current (DC current)	I_C	$T_j = T_{jmax}$ $T_s = 80\text{ °C}$	78	A
Repetitive peak collector current	I_{CRM}	t_p limited by T_{jmax}	400	A
Total power dissipation	P_{tot}	$T_j = T_{jmax}$ $T_s = 80\text{ °C}$	124	W
Gate-emitter voltage	V_{GES}		± 30	V
Maximum junction temperature	T_{jmax}		175	°C
Positive Neutral Point Switch				
Collector-emitter voltage	V_{CES}		650	V
Collector current (DC current)	I_C	$T_j = T_{jmax}$ $T_s = 80\text{ °C}$	78	A
Repetitive peak collector current	I_{CRM}	t_p limited by T_{jmax}	400	A
Total power dissipation	P_{tot}	$T_j = T_{jmax}$ $T_s = 80\text{ °C}$	124	W
Gate-emitter voltage	V_{GES}		± 30	V
Maximum junction temperature	T_{jmax}		175	°C
Negative Boost Diode				
Peak repetitive reverse voltage	V_{RRM}		650	V
Forward current (DC current)	I_F	$T_j = T_{jmax}$ $T_s = 80\text{ °C}$	36	A
Repetitive peak forward current	I_{FRM}	t_p limited by T_{jmax}	120	A
Surge (non-repetitive) forward current	I_{FSM}	$t_p = 10\text{ }\mu\text{s}$ $T_j = 25\text{ °C}$	450	A
Total power dissipation	P_{tot}	$T_j = T_{jmax}$ $T_s = 80\text{ °C}$	64	W
Maximum junction temperature	T_{jmax}		175	°C



Vincotech

Maximum Ratings

$T_j = 25\text{ °C}$, unless otherwise specified

Parameter	Symbol	Conditions	Value	Unit
Positive Boost Diode				
Peak repetitive reverse voltage	V_{RRM}		650	V
Forward current (DC current)	I_F	$T_j = T_{jmax}$ $T_s = 80\text{ °C}$	36	A
Repetitive peak forward current	I_{FRM}	t_p limited by T_{jmax}	120	A
Surge (non-repetitive) forward current	I_{FSM}	$t_p = 10\ \mu\text{s}$ $T_j = 25\text{ °C}$	450	A
Total power dissipation	P_{tot}	$T_j = T_{jmax}$ $T_s = 80\text{ °C}$	64	W
Maximum junction temperature	T_{jmax}		175	°C
Negative Neutral Point Diode				
Peak repetitive reverse voltage	V_{RRM}		1600	V
Forward current (DC current)	I_F	$T_j = T_{jmax}$ $T_s = 80\text{ °C}$	96	A
Surge (non-repetitive) forward current	I_{FSM}	Single Half Sine Wave, $t_p = 10\text{ ms}$ $T_j = 150\text{ °C}$	890	A
Surge current capability	I^2t		3960	A ² s
Total power dissipation	P_{tot}	$T_j = T_{jmax}$ $T_s = 80\text{ °C}$	104	W
Maximum junction temperature	T_{jmax}		150	°C
Positive Neutral Point Diode				
Peak repetitive reverse voltage	V_{RRM}		1600	V
Forward current (DC current)	I_F	$T_j = T_{jmax}$ $T_s = 80\text{ °C}$	120	A
Surge (non-repetitive) forward current	I_{FSM}	Single Half Sine Wave, $t_p = 10\text{ ms}$ $T_j = 150\text{ °C}$	1380	A
Surge current capability	I^2t		9520	A ² s
Total power dissipation	P_{tot}	$T_j = T_{jmax}$ $T_s = 80\text{ °C}$	132	W
Maximum junction temperature	T_{jmax}		150	°C



Vincotech

Maximum Ratings

$T_j = 25\text{ °C}$, unless otherwise specified

Parameter	Symbol	Conditions	Value	Unit
Positive Boost Diode Protection Diode				
Peak repetitive reverse voltage	V_{RRM}		650	V
Forward current (DC current)	I_F	$T_j = T_{jmax}$ $T_s = 80\text{ °C}$	23	A
Repetitive peak forward current	I_{FRM}	t_p limited by T_{jmax}	40	A
Total power dissipation	P_{tot}	$T_j = T_{jmax}$ $T_s = 80\text{ °C}$	39	W
Maximum junction temperature	T_{jmax}		175	°C

Positive Boost Blocking Diode

Peak repetitive reverse voltage	V_{RRM}		1600	V
Forward current (DC current)	I_F	$T_j = T_{jmax}$ $T_s = 80\text{ °C}$	96	A
Surge (non-repetitive) forward current	I_{FSM}	Single Half Sine Wave, $t_p = 10\text{ ms}$ $T_j = 150\text{ °C}$	890	A
Surge current capability	$I \cdot t$		3960	A ² s
Total power dissipation	P_{tot}	$T_j = T_{jmax}$ $T_s = 80\text{ °C}$	104	W
Maximum junction temperature	T_{jmax}		150	°C

Capacitor (DC)

Maximum DC voltage	V_{MAX}		630	V
Operation Temperature	T_{op}		-55 ... 125	°C

Module Properties

Thermal Properties

Storage temperature	T_{stg}		-40...+125	°C
Operation temperature under switching condition	T_{jop}		-40...+($T_{jmax} - 25$)	°C

Isolation Properties

Isolation voltage	V_{isol}	DC Test Voltage* $t_p = 2\text{ s}$	6000	V
Isolation voltage	V_{isol}	AC Voltage $t_p = 1\text{ min}$	2500	V
Creepage distance			>12,7	mm
Clearance			9,65	mm
Comparative Tracking Index	CTI		≥ 200	

*100 % tested in production



Vincotech

Characteristic Values

Parameter	Symbol	Conditions					Values			Unit
		V_{GE} [V] V_{GS} [V]	V_{CE} [V] V_{DS} [V] V_F [V]	I_C [A] I_D [A] I_F [A]	T_j [°C]	Min	Typ	Max		

Negative Neutral Point Switch

Static

Gate-emitter threshold voltage	$V_{GE(th)}$			5	0,066	25	5	6	7	V
Collector-emitter saturation voltage	$V_{CE(sat)}$		15		100	25 125 150		1,5 1,66 1,7	1,9 ⁽¹⁾	V
Collector-emitter cut-off current	I_{CES}		0	650		25			0,02	mA
Gate-emitter leakage current	I_{GES}		30	0		25			0,4	μA
Internal gate resistance	r_g							None		Ω
Input capacitance	C_{ies}							8400		pF
Output capacitance	C_{oes}	$f = 1$ Mhz	0	30		25		208		pF
Reverse transfer capacitance	C_{res}							158		pF
Gate charge	Q_g		15	400	100	25		282		nC

Thermal

Thermal resistance junction to sink ⁽²⁾	$R_{th(j-s)}$	$\lambda_{paste} = 3,4$ W/mK (PSX)						0,76		K/W
----------------------------------------------------	---------------	---------------------------------------	--	--	--	--	--	------	--	-----

Dynamic

Turn-on delay time	$t_{d(on)}$					25 125 150		47,7 42,9 41,78		ns
Rise time	t_r					25 125 150		17,65 18,49 18,62		ns
Turn-off delay time	$t_{d(off)}$					25 125 150		241,12 272,32 282,09		ns
Fall time	t_f					25 125 150		22,19 37,47 42,55		ns
Turn-on energy (per pulse)	E_{on}	$Q_{tFWD} = 0,063$ μC $Q_{tFWD} = 0,061$ μC $Q_{tFWD} = 0,062$ μC				25 125 150		0,576 0,588 0,631		mWs
Turn-off energy (per pulse)	E_{off}					25 125 150		1,3 1,68 1,81		mWs



Vincotech

Characteristic Values

Parameter	Symbol	Conditions					Values			Unit
		V_{GS} [V]	V_{GE} [V]	V_{DS} [V]	I_D [A]	T_j [°C]	Min	Typ	Max	

Positive Neutral Point Switch

Static

Gate-emitter threshold voltage	$V_{GE(th)}$			5	0,066	25	5	6	7	V
Collector-emitter saturation voltage	$V_{CE(sat)}$		15		100	25 125 150		1,5 1,66 1,7	1,9 ⁽¹⁾	V
Collector-emitter cut-off current	I_{CES}		0	650		25			0,02	mA
Gate-emitter leakage current	I_{GES}		30	0		25			0,4	μA
Internal gate resistance	r_g							None		Ω
Input capacitance	C_{ies}							8400		pF
Output capacitance	C_{oes}	$f = 1$ Mhz	0	30		25		208		pF
Reverse transfer capacitance	C_{res}							158		pF
Gate charge	Q_g		15	400	100	25		282		nC

Thermal

Thermal resistance junction to sink ⁽²⁾	$R_{th(j-s)}$	$\lambda_{paste} = 3,4$ W/mK (PSX)						0,76		K/W
----------------------------------------------------	---------------	------------------------------------	--	--	--	--	--	------	--	-----

Dynamic

Turn-on delay time	$t_{d(on)}$					25 125 150		46,89 42,58 41,59		ns
Rise time	t_r					25 125 150		19,92 20,62 20,78		ns
Turn-off delay time	$t_{d(off)}$					25 125 150		247,83 277,72 287,06		ns
Fall time	t_f					25 125 150		29,8 49,3 56,14		ns
Turn-on energy (per pulse)	E_{on}	$Q_{tFWD} = 0,067$ μC $Q_{tFWD} = 0,064$ μC $Q_{tFWD} = 0,066$ μC				25 125 150		0,542 0,577 0,575		mWs
Turn-off energy (per pulse)	E_{off}					25 125 150		1,38 1,83 1,98		mWs



Vincotech

10-PZ07ANA100RG03-LK39L38Y
datasheet

Characteristic Values

Parameter	Symbol	Conditions					Values			Unit
		V_{GE} [V] V_{GS} [V]	V_{CE} [V] V_{DS} [V] V_F [V]	I_C [A] I_D [A] I_F [A]	T_j [°C]	Min	Typ	Max		
Negative Boost Diode										
Static										
Forward voltage	V_F				30	25 125 150		1,39 1,53 1,62	1,55 ⁽¹⁾	V
Reverse leakage current	I_R	$V_i = 650$ V				25 150		6 90	600	μA
Thermal										
Thermal resistance junction to sink ⁽²⁾	$R_{th(j-s)}$	$\lambda_{paste} = 3,4$ W/mK (PSX)						1,48		K/W
Dynamic										
Peak recovery current	I_{RRM}					25 125 150		14,97 14,22 14,43		A
Reverse recovery time	t_{rr}					25 125 150		7,25 7,48 7,58		ns
Recovered charge	Q_r	$di/dt=3461$ A/μs $di/dt=3147$ A/μs $di/dt=3733$ A/μs	0/15	400	60	25 125 150		0,063 0,061 0,062		μC
Reverse recovered energy	E_{rec}					25 125 150		0,011 0,01 0,011		mWs
Peak rate of fall of recovery current	$(di_r/dt)_{max}$					25 125 150		7290,38 6727,87 6398,5		A/μs



Vincotech

Characteristic Values

Parameter	Symbol	Conditions					Values			Unit
		V_{GE} [V] V_{GS} [V]	V_{CE} [V] V_{DS} [V] V_F [V]	I_C [A] I_D [A] I_F [A]	T_j [°C]	Min	Typ	Max		
Positive Boost Diode										
Static										
Forward voltage	V_F				30	25 125 150		1,39 1,53 1,62	1,55 ⁽¹⁾	V
Reverse leakage current	I_R	$V_T = 650$ V				25 150		6 90	600	μA
Thermal										
Thermal resistance junction to sink ⁽²⁾	$R_{th(j-s)}$	$\lambda_{paste} = 3,4$ W/mK (PSX)						1,48		K/W
Dynamic										
Peak recovery current	I_{RRM}					25 125 150		12,65 12,1 12,06		A
Reverse recovery time	t_{rr}					25 125 150		8,93 8,95 9,1		ns
Recovered charge	Q_r	$di/dt=2881$ A/μs $di/dt=2815$ A/μs $di/dt=3139$ A/μs	0/15	400	60	25 125 150		0,067 0,064 0,066		μC
Reverse recovered energy	E_{rec}					25 125 150		0,015 0,014 0,014		mWs
Peak rate of fall of recovery current	$(di_r/dt)_{max}$					25 125 150		4821,82 4292,67 4768,55		A/μs



Vincotech

Characteristic Values

Parameter	Symbol	Conditions					Values			Unit
		V_{GS} [V]	V_{GE} [V]	V_{DS} [V]	I_D [A]	T_j [°C]	Min	Typ	Max	

Negative Neutral Point Diode

Static

Forward voltage	V_F				60	25 125 150		1,04 0,973 0,956	1,5 ⁽¹⁾	V
Reverse leakage current	I_R	$V_r = 1600$ V				25 150			100 2	μ A

Thermal

Thermal resistance junction to sink ⁽²⁾	$R_{th(j-s)}$	$\lambda_{paste} = 3,4$ W/mK (PSX)						0,67		K/W
----------------------------------------------------	---------------	------------------------------------	--	--	--	--	--	------	--	-----

Positive Neutral Point Diode

Static

Forward voltage	V_F				110	25 125		1,22 1,11	1,5 ⁽¹⁾	V
Reverse leakage current	I_R	$V_r = 1600$ V				25 150			100 2000	μ A

Thermal

Thermal resistance junction to sink ⁽²⁾	$R_{th(j-s)}$	$\lambda_{paste} = 3,4$ W/mK (PSX)						0,53		K/W
----------------------------------------------------	---------------	------------------------------------	--	--	--	--	--	------	--	-----



Vincotech

Characteristic Values

Parameter	Symbol	Conditions					Values			Unit
		V_{GE} [V] V_{GS} [V]	V_{CE} [V] V_{DS} [V] V_F [V]	I_C [A] I_D [A] I_F [A]	T_j [°C]	Min	Typ	Max		

Positive Boost Diode Protection Diode

Static

Forward voltage	V_F				20	25 125 150	1,23	1,74 1,65 1,61	1,87 ⁽¹⁾	V
Reverse leakage current	I_R	$V_i = 650$ V				25			0,24	μA

Thermal

Thermal resistance junction to sink ⁽²⁾	$R_{th(j-s)}$	$\lambda_{paste} = 3,4$ W/mK (PSX)						2,46		K/W
----------------------------------------------------	---------------	---------------------------------------	--	--	--	--	--	------	--	-----

Positive Boost Blocking Diode

Static

Forward voltage	V_F				60	25 125 150		1,04 0,973 0,956	1,5 ⁽¹⁾	V
Reverse leakage current	I_R	$V_i = 1600$ V				25 150			100 2	μA

Thermal

Thermal resistance junction to sink ⁽²⁾	$R_{th(j-s)}$	$\lambda_{paste} = 3,4$ W/mK (PSX)						0,67		K/W
----------------------------------------------------	---------------	---------------------------------------	--	--	--	--	--	------	--	-----

Capacitor (DC)

Static

Capacitance	C	DC bias voltage = 0 V				25		100		nF
Tolerance							-10		10	%



Vincotech

Characteristic Values

Parameter	Symbol	Conditions					Values			Unit
		V_{GS} [V]	V_{GE} [V]	V_{DS} [V]	V_{CE} [V]	I_D [A] I_F [A]	T_j [°C]	Min	Typ	

Thermistor

Static

Rated resistance	R					25		22		kΩ
Deviation of R_{100}	$A_{R/R}$	$R_{100} = 1484 \Omega$				100	-5		5	%
Power dissipation	P					25		130		mW
Power dissipation constant	d					25		1,5		mW/K
B-value	$B_{(25/50)}$	Tol. $\pm 1 \%$						3962		K
B-value	$B_{(25/100)}$	Tol. $\pm 1 \%$						4000		K
Vincotech Thermistor Reference									I	

⁽¹⁾ Value at chip level

⁽²⁾ Only valid with pre-applied Vincotech thermal interface material.



Negative Neutral Point Switch Characteristics

figure 1. IGBT

Typical output characteristics

$$I_C = f(V_{CE})$$

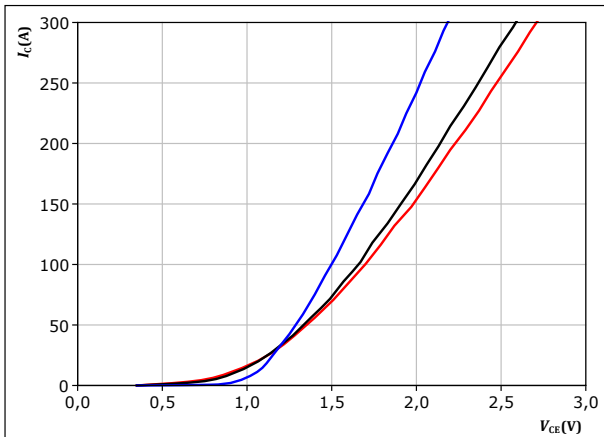

$t_p = 250\ \mu\text{s}$
 $V_{GE} = 15\ \text{V}$
 $T_j:$ — 25 °C
— 125 °C
— 150 °C

figure 2. IGBT

Typical output characteristics

$$I_C = f(V_{CE})$$

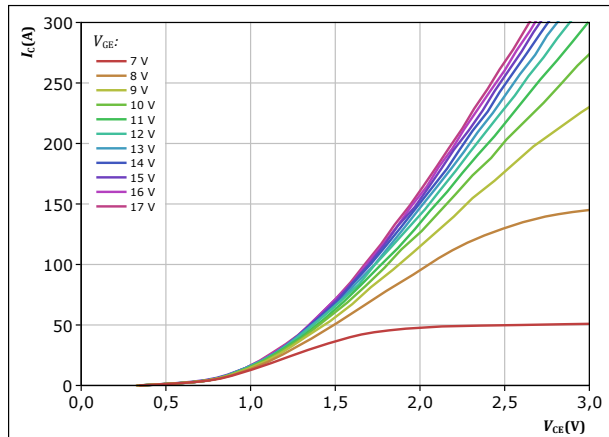

$t_p = 250\ \mu\text{s}$
 $T_j = 150\text{ °C}$
 V_{GE} from 7 V to 17 V in steps of 1 V

figure 3. IGBT

Typical transfer characteristics

$$I_C = f(V_{GE})$$

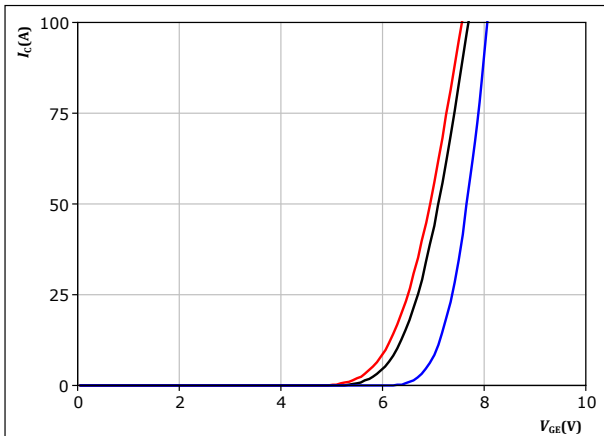

$t_p = 250\ \mu\text{s}$
 $V_{CE} = 10\ \text{V}$
 $T_j:$ — 25 °C
— 125 °C
— 150 °C

figure 4. IGBT

Transient thermal impedance as a function of pulse width

$$Z_{th(j-s)} = f(t_p)$$

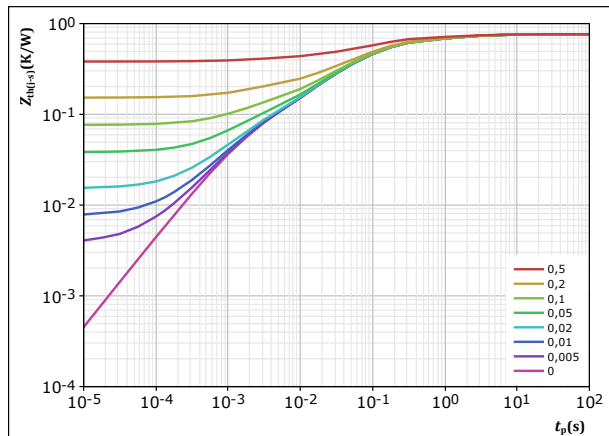

$D = t_p / T$
 $R_{th(j-s)} = 0,764\ \text{K/W}$
IGBT thermal model values

R (K/W)	τ (s)
4,18E-02	5,11E+00
1,21E-01	9,79E-01
3,88E-01	1,06E-01
1,57E-01	2,06E-02
5,52E-02	1,63E-03



Negative Neutral Point Switch Characteristics

figure 5. IGBT

Safe operating area

$$I_C = f(V_{CE})$$

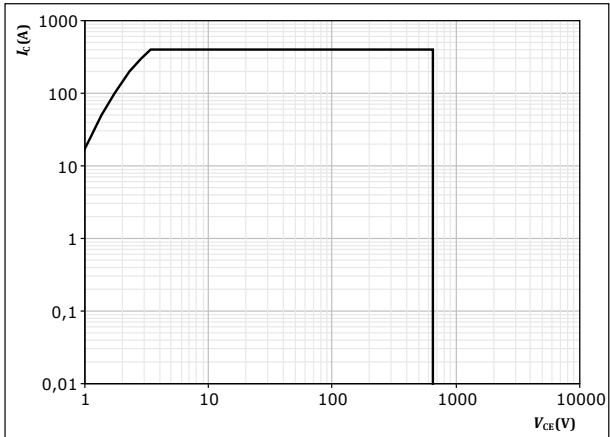

D = single pulse

T_s = 80 °C

V_{GE} = 15 V

T_j = T_{jmax}



Positive Neutral Point Switch Characteristics

figure 6. IGBT

Typical output characteristics

$$I_C = f(V_{CE})$$

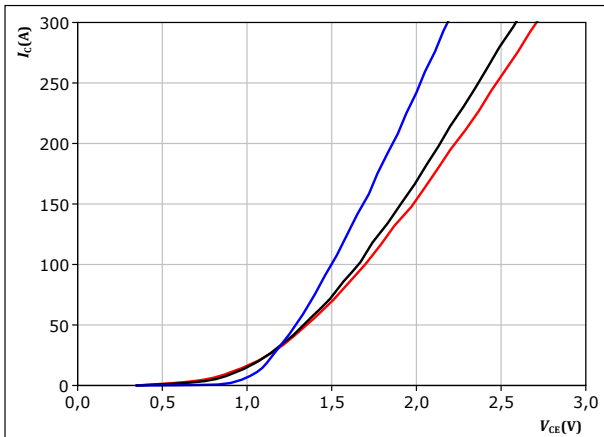

$t_p = 250 \mu s$
 $V_{GE} = 15 V$
 $T_j:$ — 25 °C
— 125 °C
— 150 °C

figure 7. IGBT

Typical output characteristics

$$I_C = f(V_{CE})$$

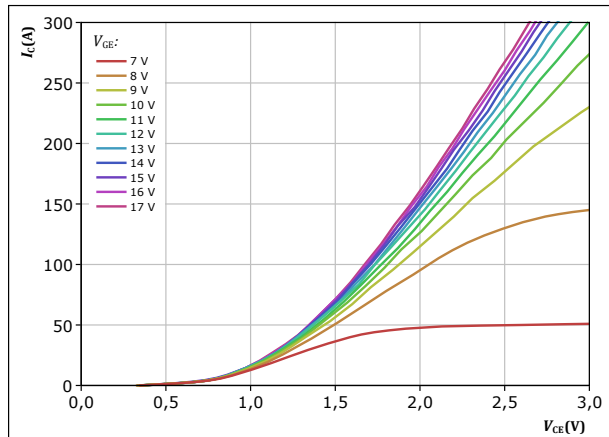

$t_p = 250 \mu s$
 $T_j = 150 \text{ °C}$
 V_{GE} from 7 V to 17 V in steps of 1 V

figure 8. IGBT

Typical transfer characteristics

$$I_C = f(V_{GE})$$

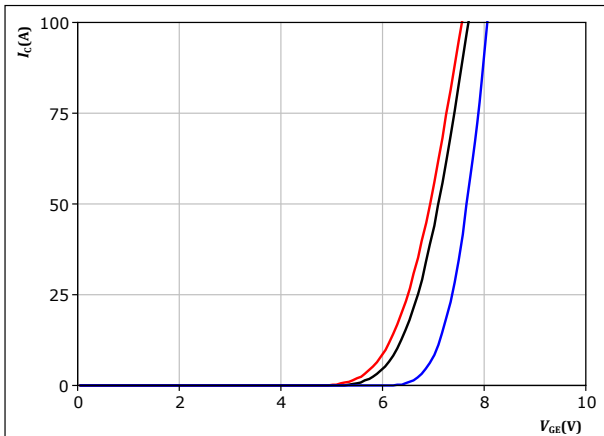

$t_p = 250 \mu s$
 $V_{CE} = 10 V$
 $T_j:$ — 25 °C
— 125 °C
— 150 °C

figure 9. IGBT

Transient thermal impedance as a function of pulse width

$$Z_{th(j-s)} = f(t_p)$$

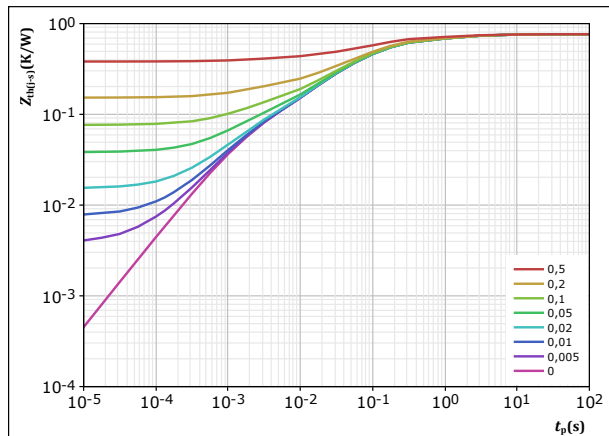

$D = t_p / T$
 $R_{th(j-s)} = 0,764 \text{ K/W}$
IGBT thermal model values

R (K/W)	τ (s)
4,18E-02	5,11E+00
1,21E-01	9,79E-01
3,88E-01	1,06E-01
1,57E-01	2,06E-02
5,52E-02	1,63E-03



Positive Neutral Point Switch Characteristics

figure 10. IGBT

Safe operating area

$$I_C = f(V_{CE})$$

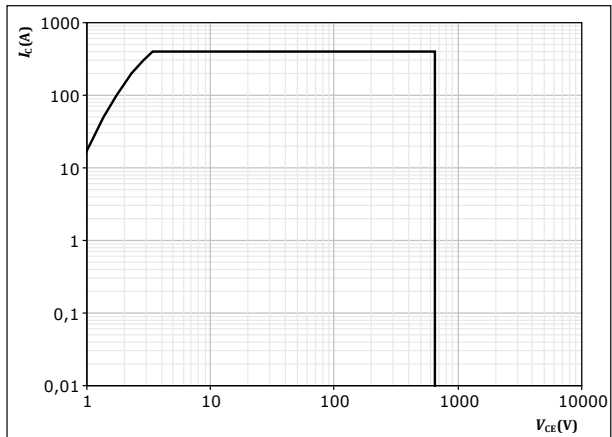

D = single pulse
T_s = 80 °C
V_{CE} = 15 V
T_j = T_{jmax}



Negative Boost Diode Characteristics

figure 11. FWD

Typical forward characteristics

$$I_F = f(V_F)$$

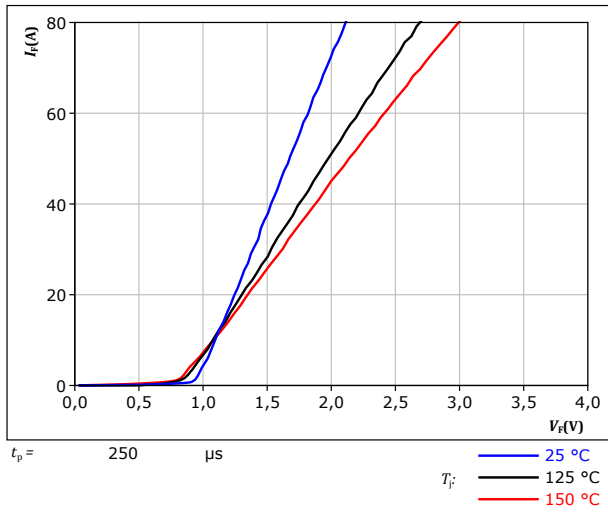
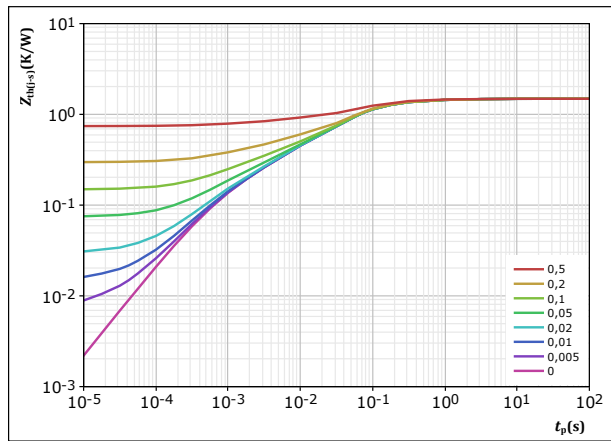

figure 12. FWD

Transient thermal impedance as a function of pulse width

$$Z_{th(j-s)} = f(t_p)$$



$D =$	t_p / T	
$R_{th(j-s)} =$	1,485	K/W
FWD thermal model values		
R (K/W)	τ (s)	
6,45E-02	1,95E+00	
2,63E-01	2,25E-01	
8,47E-01	5,10E-02	
2,23E-01	4,17E-03	
8,76E-02	5,85E-04	



Positive Boost Diode Characteristics

figure 13. FWD

Typical forward characteristics

$$I_F = f(V_F)$$

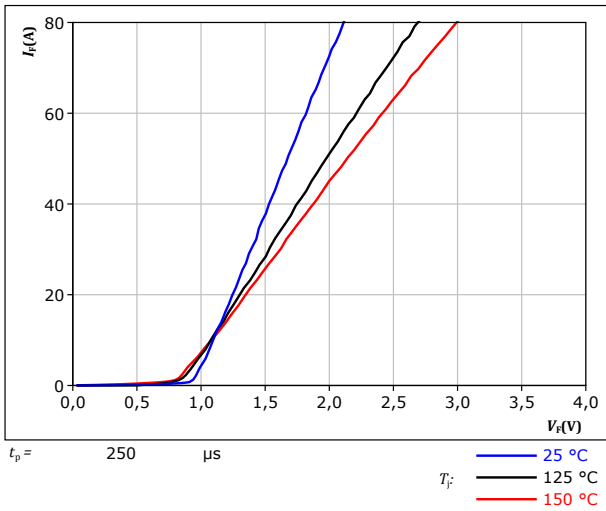
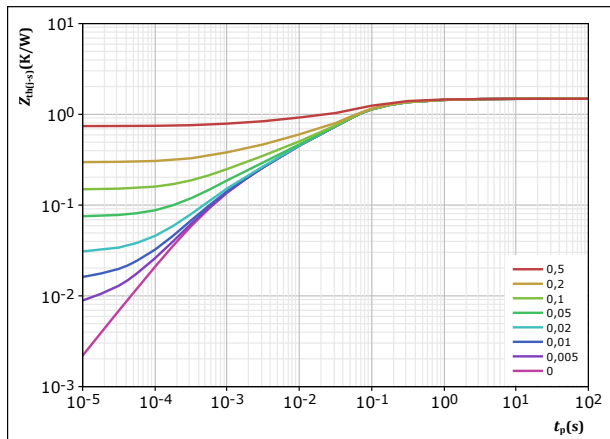

figure 14. FWD

Transient thermal impedance as a function of pulse width

$$Z_{th(j-s)} = f(t_p)$$



$D =$	t_p / T	
$R_{th(j-s)} =$	1,485	K/W
FWD thermal model values		
R (K/W)	τ (s)	
6,45E-02	1,95E+00	
2,63E-01	2,25E-01	
8,47E-01	5,10E-02	
2,23E-01	4,17E-03	
8,76E-02	5,85E-04	



Negative Neutral Point Diode Characteristics

figure 15. Rectifier

Typical forward characteristics

$$I_F = f(V_F)$$

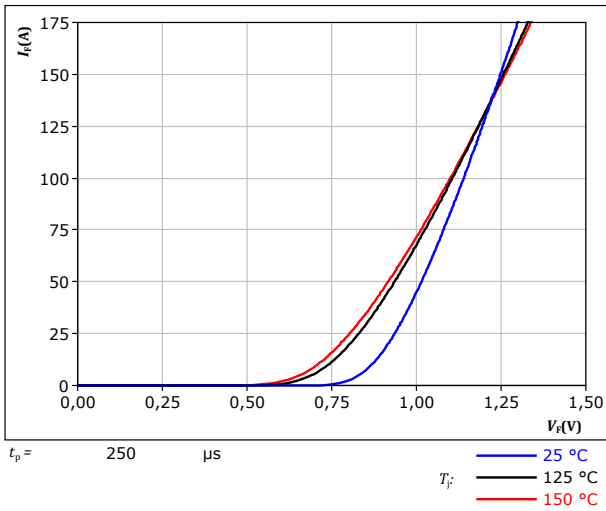
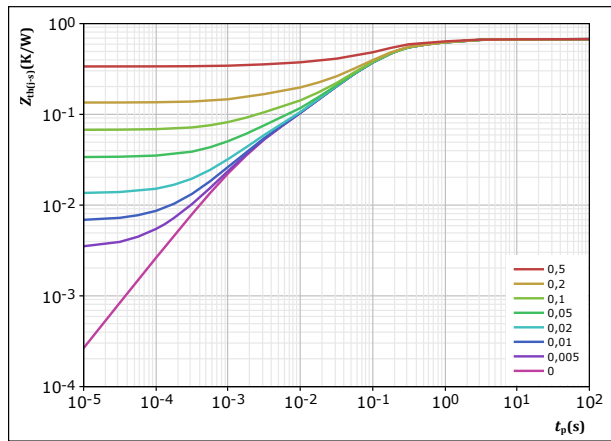

figure 16. Rectifier

Transient thermal impedance as a function of pulse width

$$Z_{th(j-s)} = f(t_p)$$



$D = \frac{t_p}{T}$
 $R_{th(j-s)} = 0,674 \text{ K/W}$
 Rectifier thermal model values

R (K/W)	τ (s)
9,07E-03	2,25E+01
1,33E-01	9,04E-01
4,31E-01	1,10E-01
6,46E-02	1,69E-02
3,61E-02	1,93E-03



Positive Neutral Point Diode Characteristics

figure 17. Rectifier

Typical forward characteristics

$$I_F = f(V_F)$$

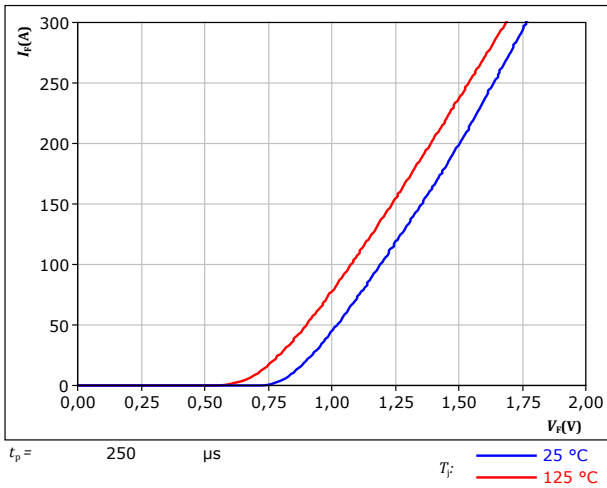
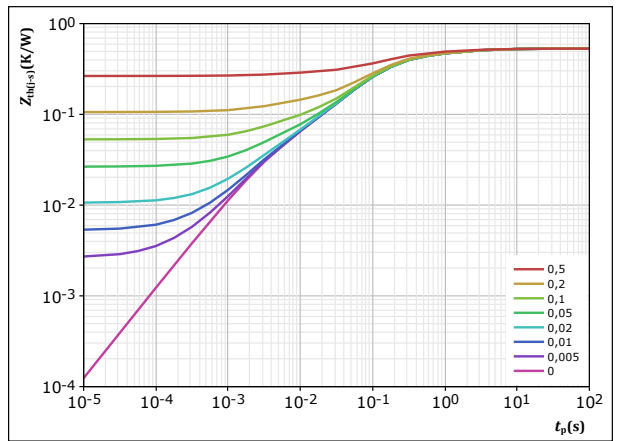

figure 18. Rectifier

Transient thermal impedance as a function of pulse width

$$Z_{th(j-s)} = f(t_p)$$



$D = t_p / T$

$R_{th(j-s)} = 0,53 \text{ K/W}$

Rectifier thermal model values

$R \text{ (K/W)}$	$\tau \text{ (s)}$
1,56E-02	8,53E+00
9,06E-02	1,44E+00
2,54E-01	1,78E-01
1,38E-01	6,01E-02
3,18E-02	3,70E-03



Positive Boost Diode Protection Diode Characteristics

figure 19. FWD

Typical forward characteristics

$$I_F = f(V_F)$$

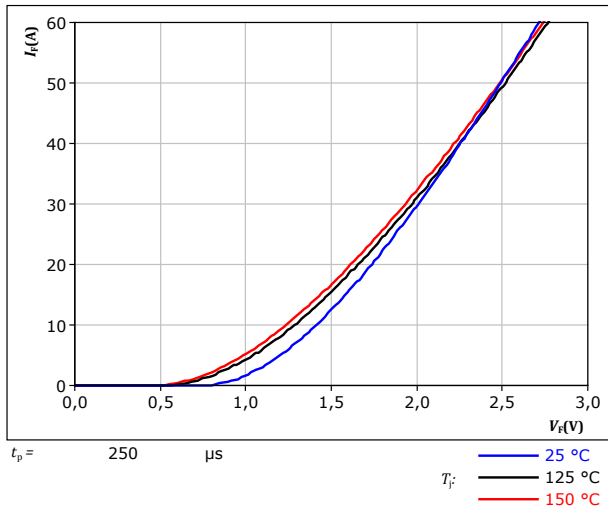
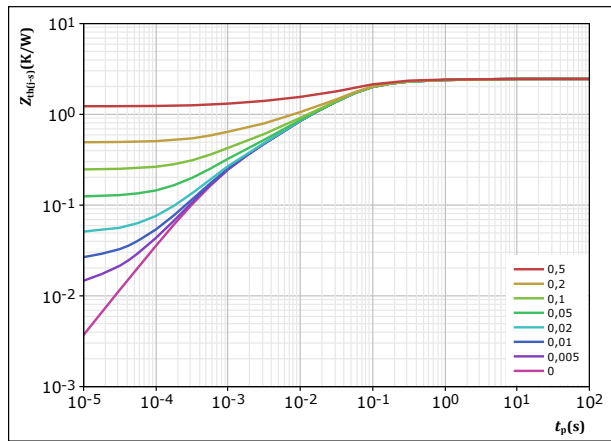

figure 20. FWD

Transient thermal impedance as a function of pulse width

$$Z_{th(j-s)} = f(t_p)$$



$D = \frac{t_p}{T}$
 $R_{th(j-s)} = 2,457 \text{ K/W}$
 FWD thermal model values

R (K/W)	τ (s)
1,00E-01	2,27E+00
3,37E-01	2,00E-01
1,37E+00	4,58E-02
4,51E-01	6,21E-03
2,01E-01	7,45E-04



Positive Boost Blocking Diode Characteristics

figure 21. Rectifier

Typical forward characteristics

$$I_F = f(V_F)$$

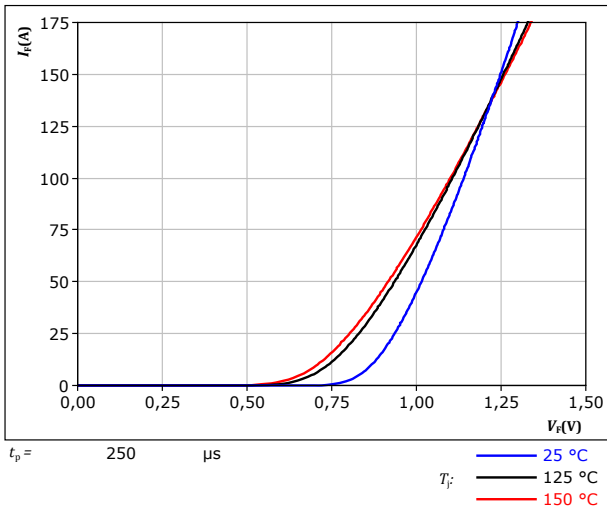
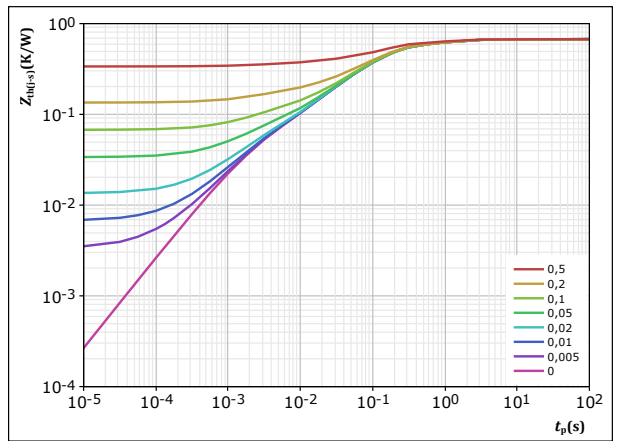

figure 22. Rectifier

Transient thermal impedance as a function of pulse width

$$Z_{th(j-s)} = f(t_p)$$



$D = \frac{t_p}{T}$
 $R_{th(j-s)} = 0,674 \text{ K/W}$
 Rectifier thermal model values

R (K/W)	τ (s)
9,07E-03	2,25E+01
1,33E-01	9,04E-01
4,31E-01	1,10E-01
6,46E-02	1,69E-02
3,61E-02	1,93E-03



Thermistor Characteristics

figure 23. Thermistor

Typical NTC characteristic as function of temperature

$$R_T = f(T)$$

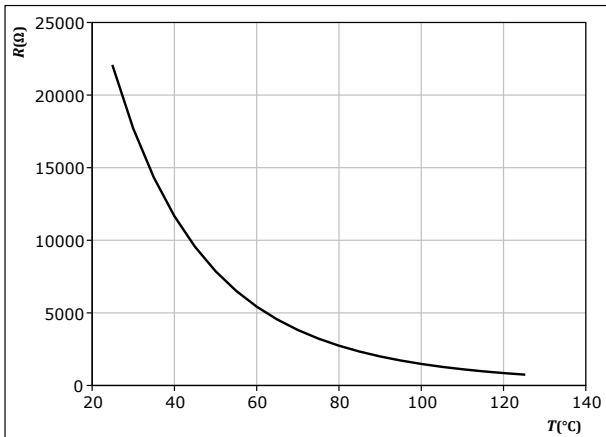



Negative Neutral Point Switching Characteristics

figure 24. IGBT

Typical switching energy losses as a function of collector current
 $E = f(I_c)$

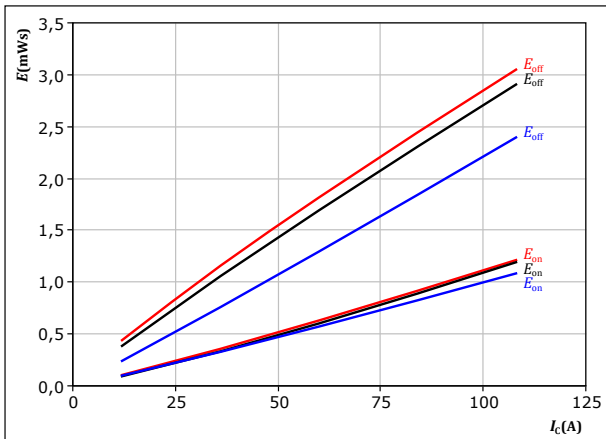

With an inductive load at
 $V_{CE} = 400$ V
 $V_{GE} = 0/15$ V
 $R_{gon} = 8$ Ω
 $R_{goff} = 8$ Ω

T_j : — 25 °C
 — 125 °C
 — 150 °C

figure 25. IGBT

Typical switching energy losses as a function of IGBT turn on gate resistor
 $E = f(R_g)$

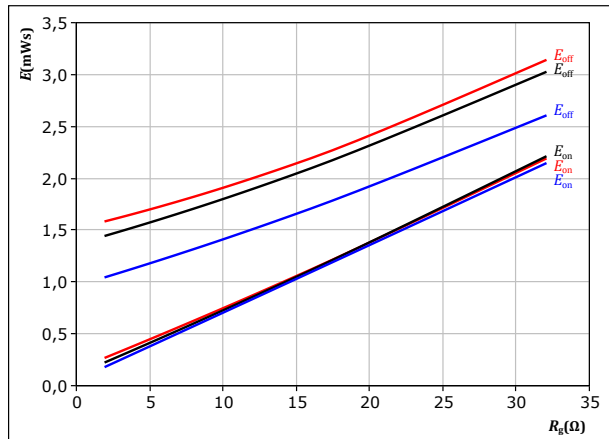

With an inductive load at
 $V_{CE} = 400$ V
 $V_{GE} = 0/15$ V
 $I_c = 60$ A

T_j : — 25 °C
 — 125 °C
 — 150 °C

figure 26. FWD

Typical reverse recovered energy loss as a function of collector current
 $E_{rec} = f(I_c)$

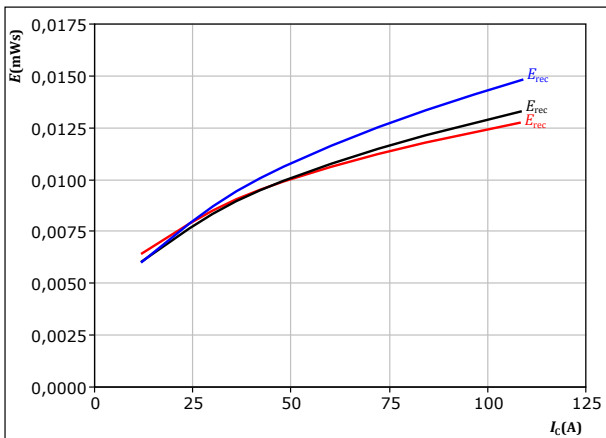

With an inductive load at
 $V_{CE} = 400$ V
 $V_{GE} = 0/15$ V
 $R_{gon} = 8$ Ω

T_j : — 25 °C
 — 125 °C
 — 150 °C

figure 27. FWD

Typical reverse recovered energy loss as a function of IGBT turn on gate resistor
 $E_{rec} = f(R_g)$

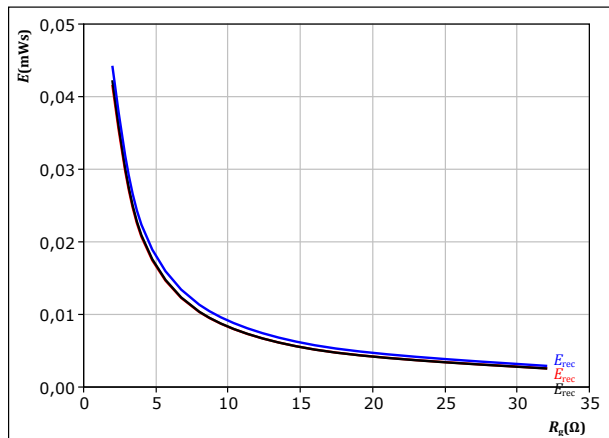

With an inductive load at
 $V_{CE} = 400$ V
 $V_{GE} = 0/15$ V
 $I_c = 60$ A

T_j : — 25 °C
 — 125 °C
 — 150 °C



Negative Neutral Point Switching Characteristics

figure 28. IGBT

Typical switching times as a function of collector current
 $t = f(I_c)$

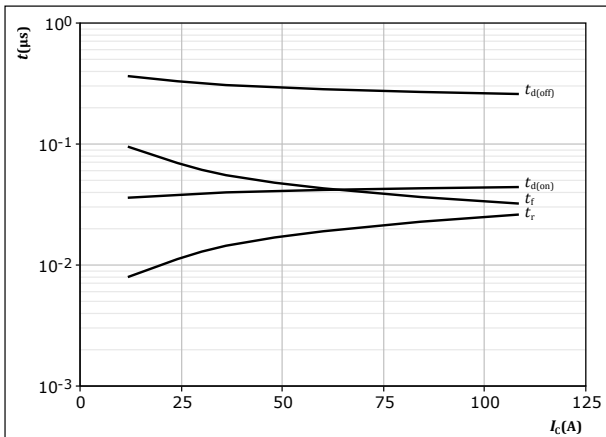

With an inductive load at
 $T_j = 150 \text{ }^\circ\text{C}$
 $V_{CE} = 400 \text{ V}$
 $V_{GE} = 0/15 \text{ V}$
 $R_{gon} = 8 \text{ } \Omega$
 $R_{goff} = 8 \text{ } \Omega$

figure 29. IGBT

Typical switching times as a function of IGBT turn on gate resistor
 $t = f(R_g)$

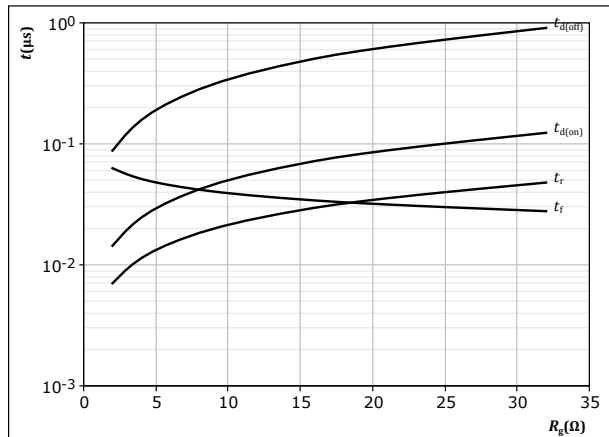

With an inductive load at
 $T_j = 150 \text{ }^\circ\text{C}$
 $V_{CE} = 400 \text{ V}$
 $V_{GE} = 0/15 \text{ V}$
 $I_c = 60 \text{ A}$

figure 30. FWD

Typical reverse recovery time as a function of collector current
 $t_{rr} = f(I_c)$

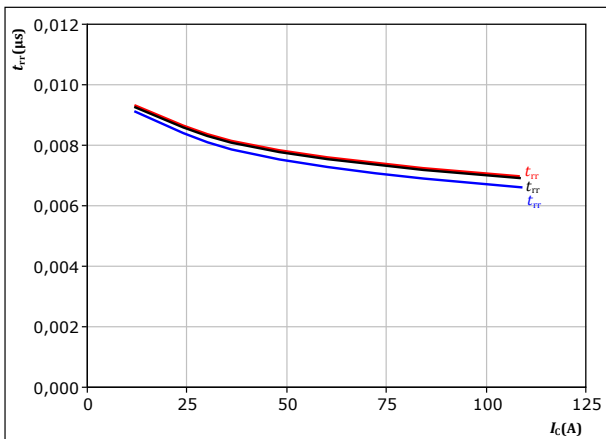

With an inductive load at
 $V_{CE} = 400 \text{ V}$
 $V_{GE} = 0/15 \text{ V}$
 $R_{gon} = 8 \text{ } \Omega$
 $T_j: \text{ } \text{---} 25 \text{ }^\circ\text{C}$
 $\text{---} 125 \text{ }^\circ\text{C}$
 $\text{---} 150 \text{ }^\circ\text{C}$

figure 31. FWD

Typical reverse recovery time as a function of IGBT turn on gate resistor
 $t_{rr} = f(R_{gon})$

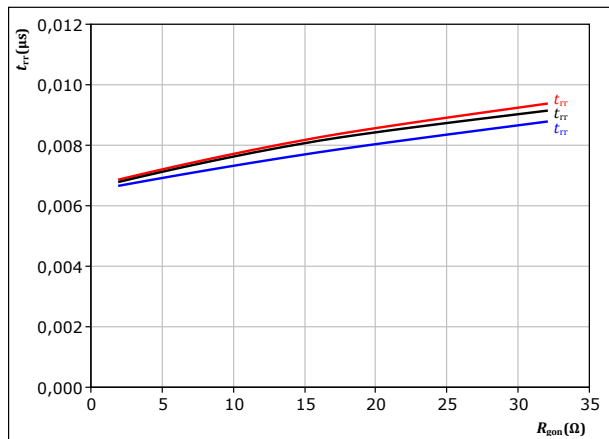

With an inductive load at
 $V_{CE} = 400 \text{ V}$
 $V_{GE} = 0/15 \text{ V}$
 $I_c = 60 \text{ A}$
 $T_j: \text{ } \text{---} 25 \text{ }^\circ\text{C}$
 $\text{---} 125 \text{ }^\circ\text{C}$
 $\text{---} 150 \text{ }^\circ\text{C}$



Negative Neutral Point Switching Characteristics

figure 32. FWD

Typical recovered charge as a function of collector current

$$Q_r = f(I_c)$$

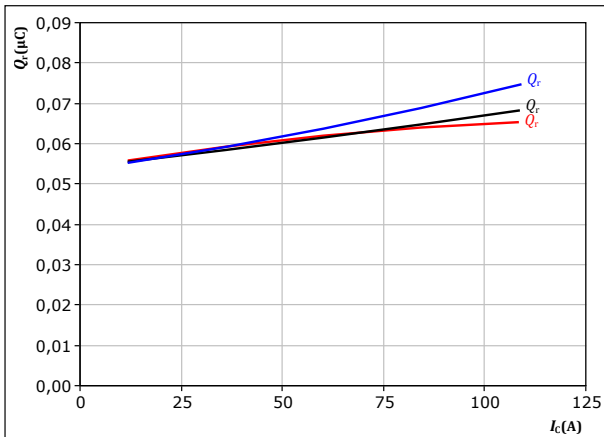

With an inductive load at

$V_{CE} = 400 \text{ V}$
 $V_{GE} = 0/15 \text{ V}$
 $R_{gon} = 8 \ \Omega$

T_j : — 25 °C
— 125 °C
— 150 °C

figure 33. FWD

Typical recovered charge as a function of IGBT turn on gate resistor

$$Q_r = f(R_{gon})$$

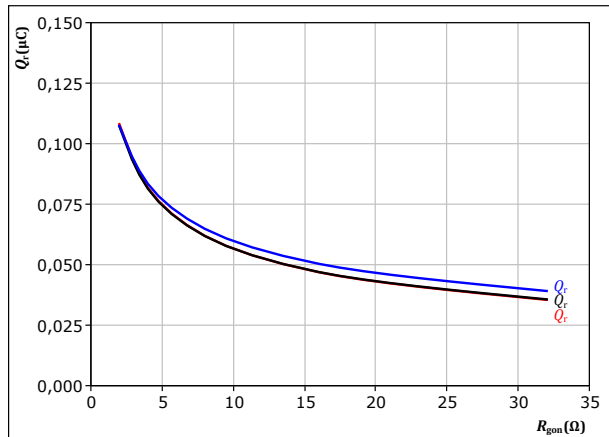

With an inductive load at

$V_{CE} = 400 \text{ V}$
 $V_{GE} = 0/15 \text{ V}$
 $I_c = 60 \text{ A}$

T_j : — 25 °C
— 125 °C
— 150 °C

figure 34. FWD

Typical peak reverse recovery current as a function of collector current

$$I_{RM} = f(I_c)$$

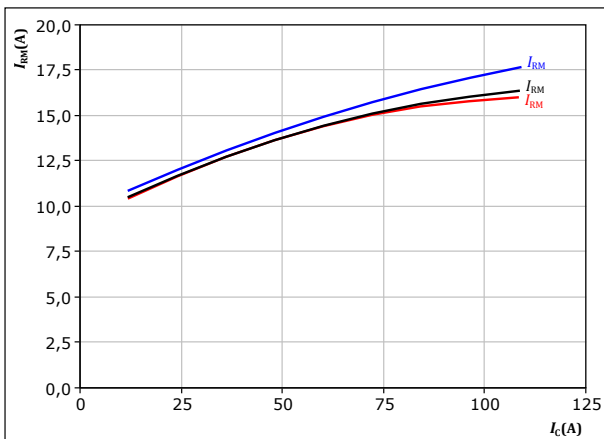

With an inductive load at

$V_{CE} = 400 \text{ V}$
 $V_{GE} = 0/15 \text{ V}$
 $R_{gon} = 8 \ \Omega$

T_j : — 25 °C
— 125 °C
— 150 °C

figure 35. FWD

Typical peak reverse recovery current as a function of IGBT turn on gate resistor

$$I_{RM} = f(R_{gon})$$

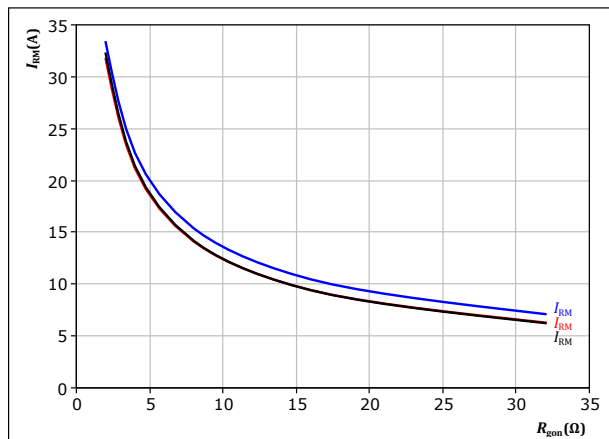

With an inductive load at

$V_{CE} = 400 \text{ V}$
 $V_{GE} = 0/15 \text{ V}$
 $I_c = 60 \text{ A}$

T_j : — 25 °C
— 125 °C
— 150 °C



Negative Neutral Point Switching Characteristics

figure 36. FWD

Typical rate of fall of forward and reverse recovery current as a function of collector current
 $di_f/dt, di_{rr}/dt = f(I_c)$

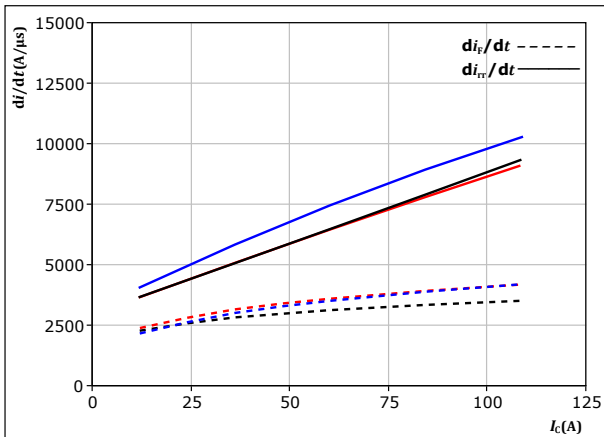

With an inductive load at

$V_{CE} = 400$ V
 $V_{GE} = 0/15$ V
 $R_{gon} = 8$ Ω

T_j : — 25 °C
 — 125 °C
 — 150 °C

figure 37. FWD

Typical rate of fall of forward and reverse recovery current as a function of turn on gate resistor
 $di_f/dt, di_{rr}/dt = f(R_{gon})$

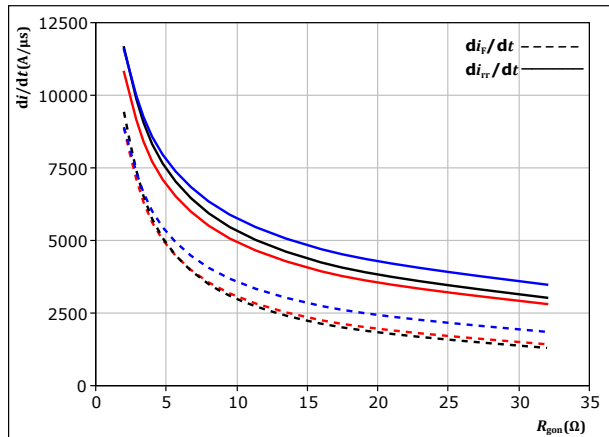

With an inductive load at

$V_{CE} = 400$ V
 $V_{GE} = 0/15$ V
 $I_c = 60$ A

T_j : — 25 °C
 — 125 °C
 — 150 °C

figure 38. IGBT

Reverse bias safe operating area

$I_c = f(V_{CE})$

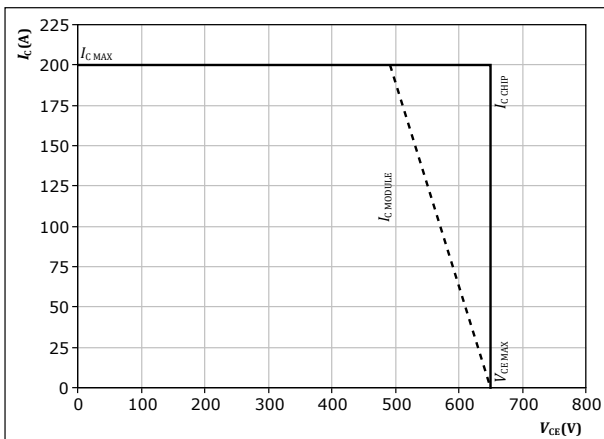

At $T_j = 150$ °C
 $R_{gon} = 8$ Ω
 $R_{goff} = 8$ Ω



Positive Neutral Point Switching Characteristics

figure 39. IGBT

Typical switching energy losses as a function of collector current
 $E = f(I_c)$

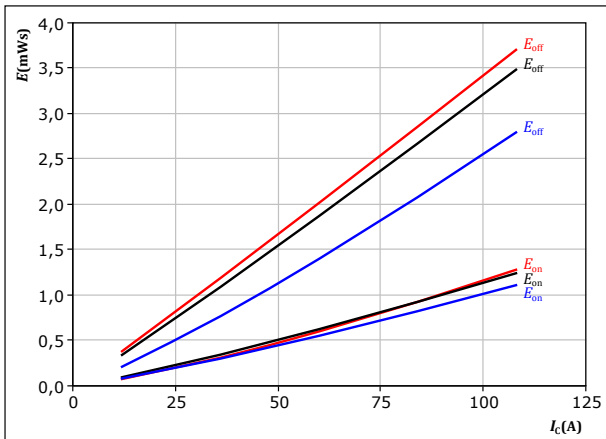

With an inductive load at

$V_{CE} = 400$ V
 $V_{GE} = 0/15$ V
 $R_{gon} = 8$ Ω
 $R_{goff} = 8$ Ω

T_j : — 25 °C
— 125 °C
— 150 °C

figure 40. IGBT

Typical switching energy losses as a function of IGBT turn on gate resistor
 $E = f(R_g)$

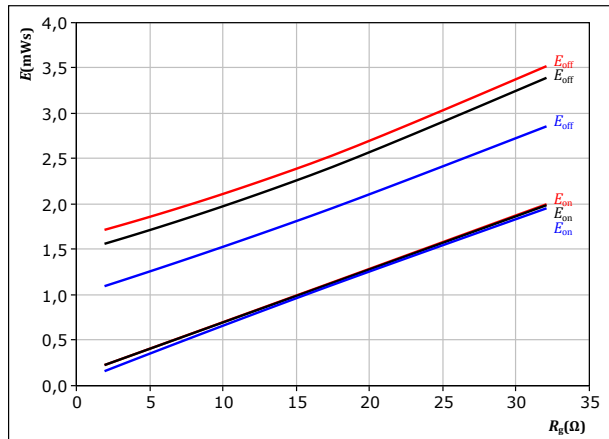

With an inductive load at

$V_{CE} = 400$ V
 $V_{GE} = 0/15$ V
 $I_c = 60$ A

T_j : — 25 °C
— 125 °C
— 150 °C

figure 41. FWD

Typical reverse recovered energy loss as a function of collector current
 $E_{rec} = f(I_c)$

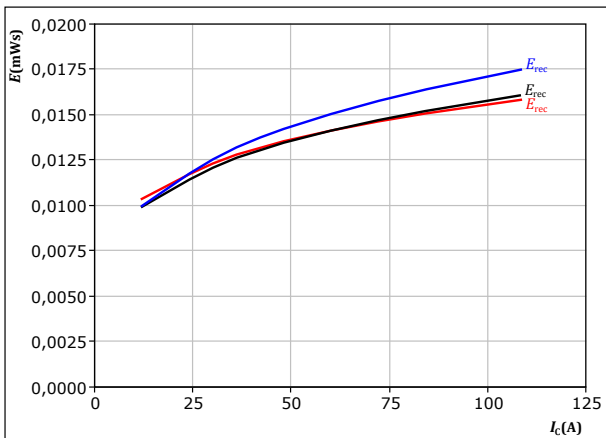

With an inductive load at

$V_{CE} = 400$ V
 $V_{GE} = 0/15$ V
 $R_{gon} = 8$ Ω

T_j : — 25 °C
— 125 °C
— 150 °C

figure 42. FWD

Typical reverse recovered energy loss as a function of IGBT turn on gate resistor
 $E_{rec} = f(R_g)$

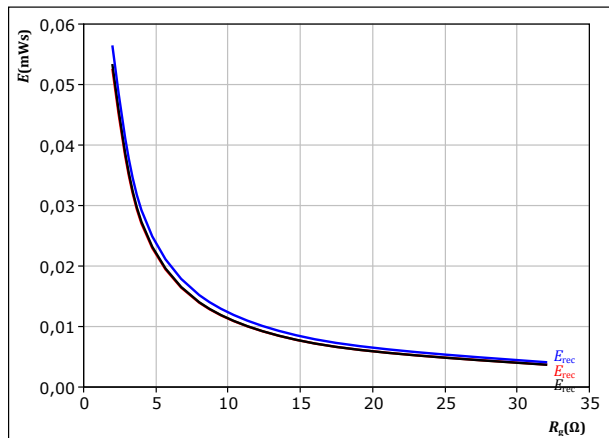

With an inductive load at

$V_{CE} = 400$ V
 $V_{GE} = 0/15$ V
 $I_c = 60$ A

T_j : — 25 °C
— 125 °C
— 150 °C



Positive Neutral Point Switching Characteristics

figure 43. IGBT

Typical switching times as a function of collector current
 $t = f(I_c)$

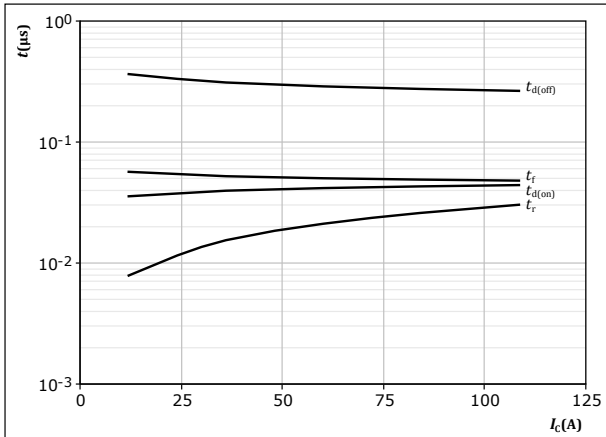

With an inductive load at
 $T_j = 150 \text{ }^\circ\text{C}$
 $V_{CE} = 400 \text{ V}$
 $V_{GE} = 0/15 \text{ V}$
 $R_{gon} = 8 \text{ } \Omega$
 $R_{goff} = 8 \text{ } \Omega$

figure 44. IGBT

Typical switching times as a function of IGBT turn on gate resistor
 $t = f(R_g)$

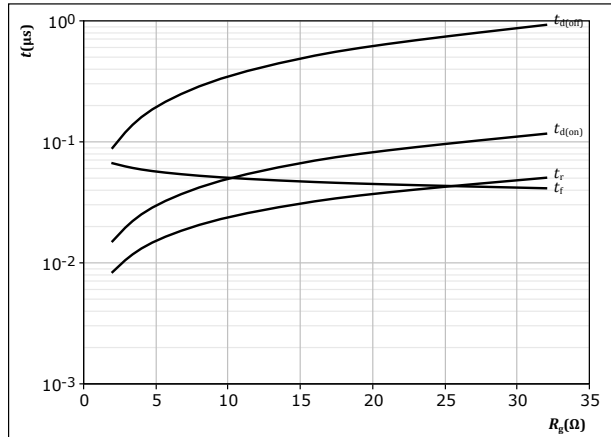

With an inductive load at
 $T_j = 150 \text{ }^\circ\text{C}$
 $V_{CE} = 400 \text{ V}$
 $V_{GE} = 0/15 \text{ V}$
 $I_c = 60 \text{ A}$

figure 45. FWD

Typical reverse recovery time as a function of collector current
 $t_{rr} = f(I_c)$

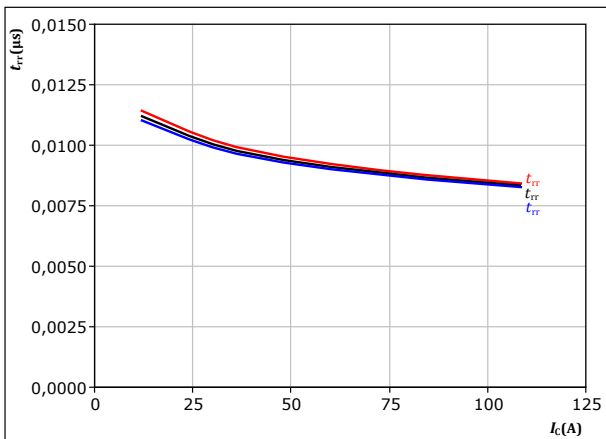

With an inductive load at
 $V_{CE} = 400 \text{ V}$
 $V_{GE} = 0/15 \text{ V}$
 $R_{gon} = 8 \text{ } \Omega$
 $T_j:$ — 25 °C
— 125 °C
— 150 °C

figure 46. FWD

Typical reverse recovery time as a function of IGBT turn on gate resistor
 $t_{rr} = f(R_{gon})$

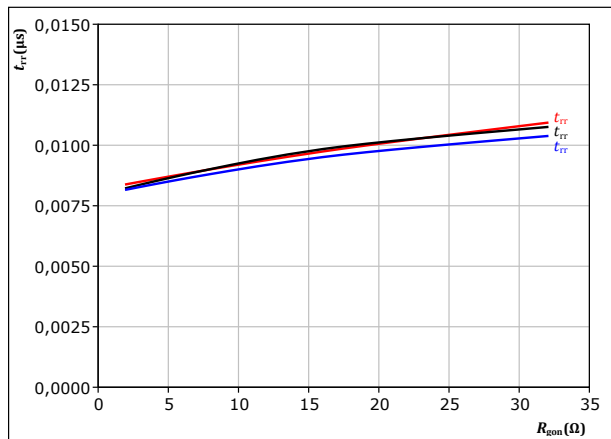

With an inductive load at
 $V_{CE} = 400 \text{ V}$
 $V_{GE} = 0/15 \text{ V}$
 $I_c = 60 \text{ A}$
 $T_j:$ — 25 °C
— 125 °C
— 150 °C



Positive Neutral Point Switching Characteristics

figure 47. FWD

Typical recovered charge as a function of collector current

$$Q_r = f(I_c)$$

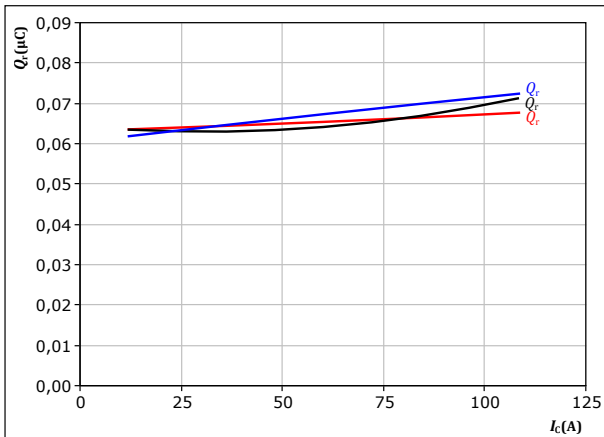

With an inductive load at

$V_{CE} = 400 \text{ V}$
 $V_{GE} = 0/15 \text{ V}$
 $R_{gon} = 8 \ \Omega$

T_j : — 25 °C
— 125 °C
— 150 °C

figure 48. FWD

Typical recovered charge as a function of IGBT turn on gate resistor

$$Q_r = f(R_{gon})$$

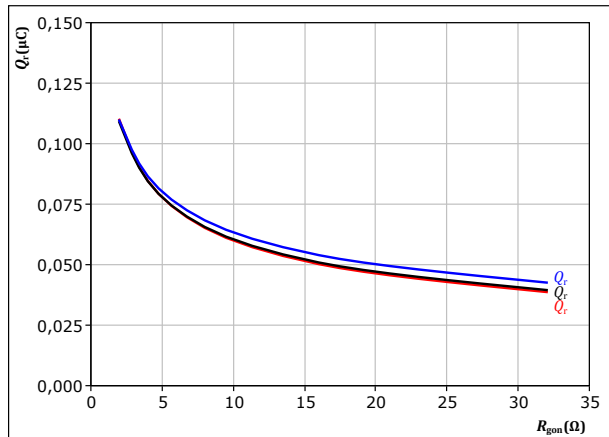

With an inductive load at

$V_{CE} = 400 \text{ V}$
 $V_{GE} = 0/15 \text{ V}$
 $I_c = 60 \text{ A}$

T_j : — 25 °C
— 125 °C
— 150 °C

figure 49. FWD

Typical peak reverse recovery current as a function of collector current

$$I_{RM} = f(I_c)$$

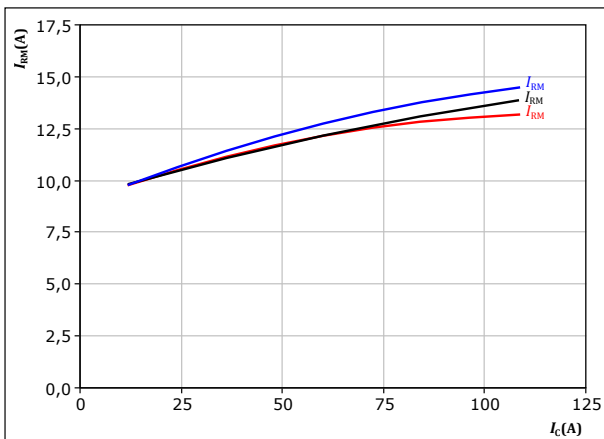

With an inductive load at

$V_{CE} = 400 \text{ V}$
 $V_{GE} = 0/15 \text{ V}$
 $R_{gon} = 8 \ \Omega$

T_j : — 25 °C
— 125 °C
— 150 °C

figure 50. FWD

Typical peak reverse recovery current as a function of IGBT turn on gate resistor

$$I_{RM} = f(R_{gon})$$

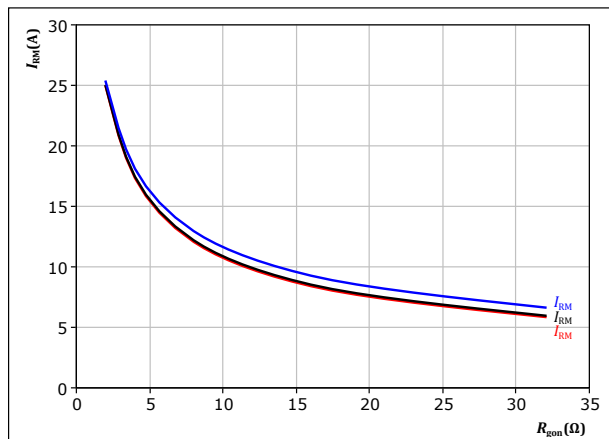

With an inductive load at

$V_{CE} = 400 \text{ V}$
 $V_{GE} = 0/15 \text{ V}$
 $I_c = 60 \text{ A}$

T_j : — 25 °C
— 125 °C
— 150 °C



Positive Neutral Point Switching Characteristics

figure 51. FWD

Typical rate of fall of forward and reverse recovery current as a function of collector current
 $di_f/dt, di_{rr}/dt = f(I_c)$

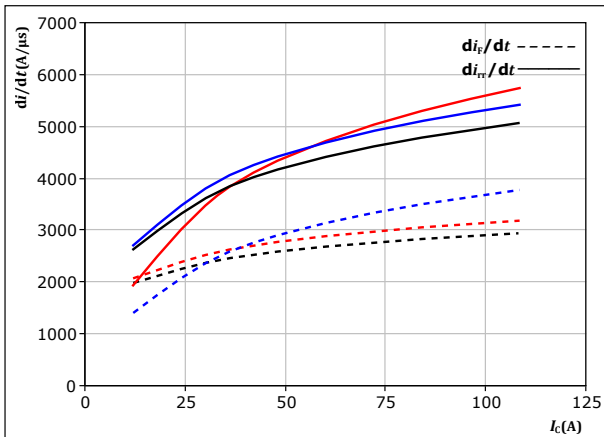

With an inductive load at

$V_{CE} = 400 \text{ V}$
 $V_{GE} = 0/15 \text{ V}$
 $R_{gon} = 8 \text{ } \Omega$

T_f :
— 25 °C
— 125 °C
— 150 °C

figure 52. FWD

Typical rate of fall of forward and reverse recovery current as a function of turn on gate resistor
 $di_f/dt, di_{rr}/dt = f(R_{gon})$

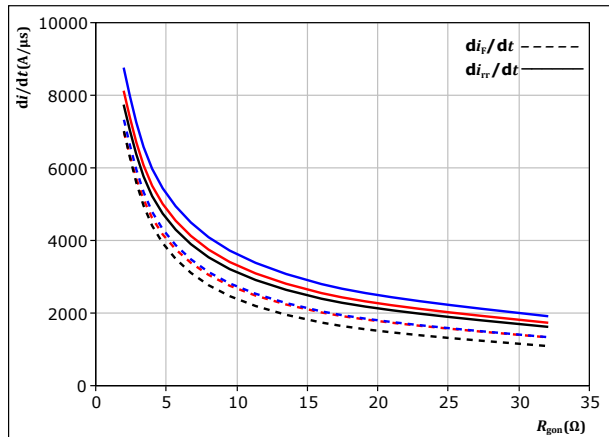

With an inductive load at

$V_{CE} = 400 \text{ V}$
 $V_{GE} = 0/15 \text{ V}$
 $I_c = 60 \text{ A}$

T_f :
— 25 °C
— 125 °C
— 150 °C

figure 53. IGBT

Reverse bias safe operating area

$I_c = f(V_{CE})$

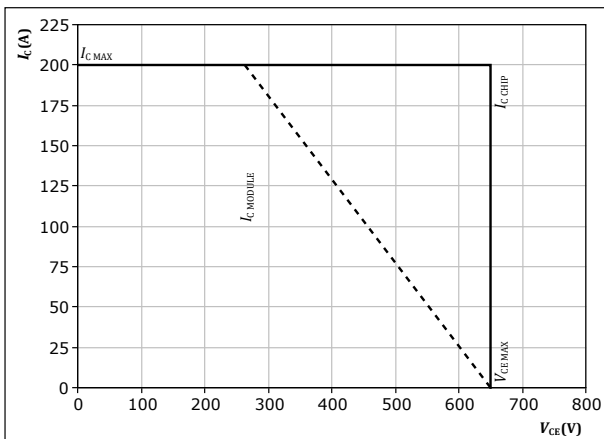

At $T_f = 150 \text{ } ^\circ\text{C}$
 $R_{gon} = 8 \text{ } \Omega$
 $R_{goff} = 8 \text{ } \Omega$



Switching Definitions

figure 54. IGBT

Turn-off Switching Waveforms & definition of t_{doff} , t_{Eoff} (t_{Eoff} = integrating time for E_{off})

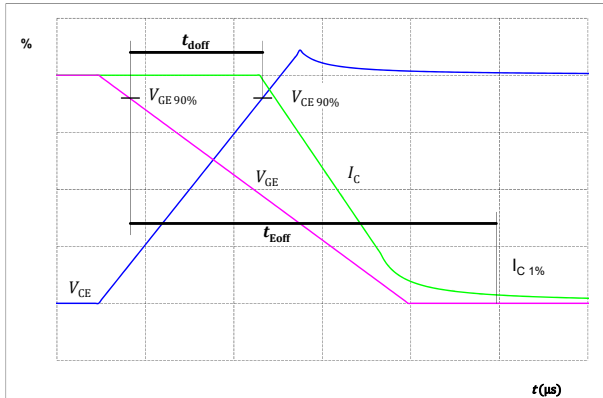

figure 55. IGBT

Turn-on Switching Waveforms & definition of t_{don} , t_{Eon} (t_{Eon} = integrating time for E_{on})

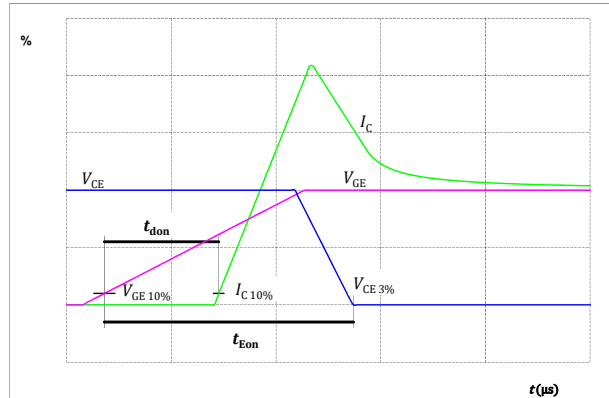

figure 56. IGBT

Turn-off Switching Waveforms & definition of t_f

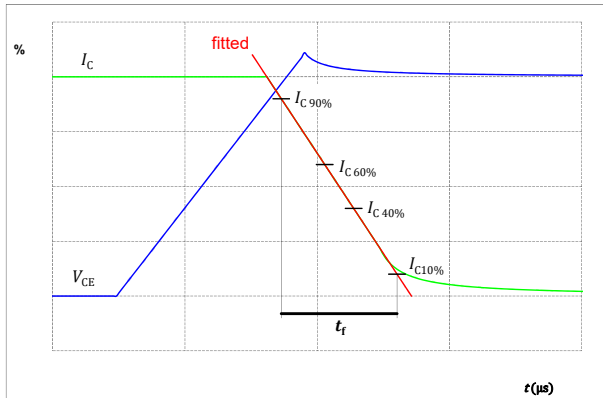
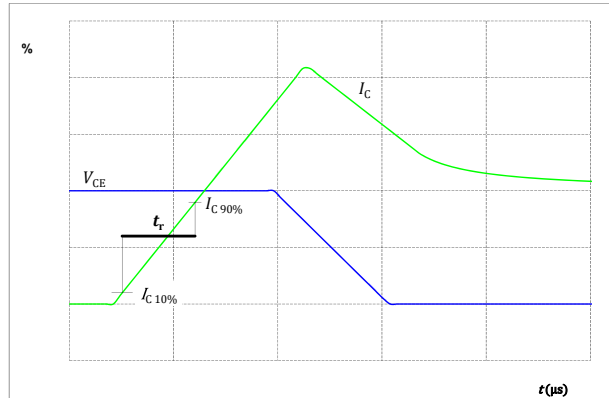

figure 57. IGBT

Turn-on Switching Waveforms & definition of t_r





Switching Definitions

figure 58. FWD

Turn-off Switching Waveforms & definition of t_{rr}

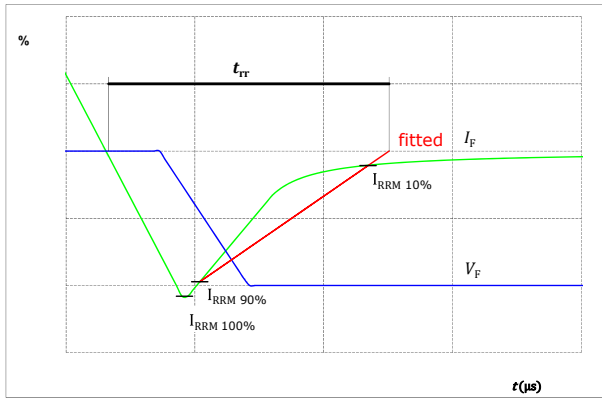
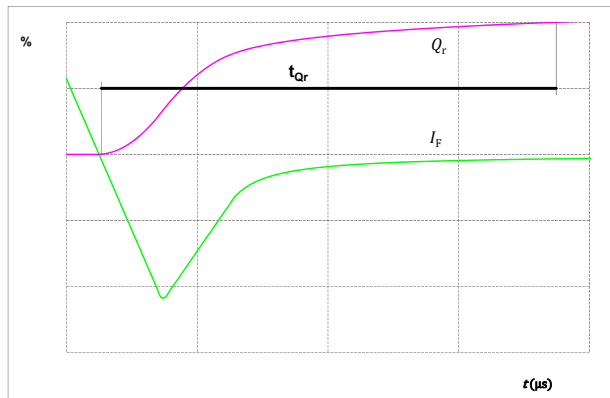

figure 59. FWD

Turn-on Switching Waveforms & definition of t_{Qr} (t_{Qr} = integrating time for Q_r)





Vincotech

10-PZ07ANA100RG03-LK39L38Y
datasheet

Ordering Code	
Version	Ordering Code
Without thermal paste	10-PZ07ANA100RG03-LK39L38Y
With thermal paste (5,2 W/mK, PTM6000HV)	10-PZ07ANA100RG03-LK39L38Y-/7/
With thermal paste (3,4 W/mK, PSX-P7)	10-PZ07ANA100RG03-LK39L38Y-/3/

Marking						
	Text	Name NN-NNNNNNNNNNNNNN- TTTTTIVV	Date code WWYY	UL & VIN UL VIN	Lot LLLLL	Serial SSSS
	Datamatrix	Type&Ver TTTTTIVV	Lot number LLLLL	Serial SSSS	Date code WWYY	

Pin table [mm]				Function
Pin	X	Y		
1	34	0		Therm1
2	31	0		Therm2
3	2,8	0		DC-
4	0	0		DC-
5	0	6,2		GND
6	0	16,8		GND
7	0	23		DC+
8	2,8	23		DC+
9	12,55	23		TM41
10	15,5	17,15		G13
11	18,5	17,15		S13
12	19,5	14,15		G13
13	31,2	23		Ph
14	34	23		Ph
15	34	20,3		Ph
16	34	17,6		Ph

Tolerance of positions: ±0.5mm at the end of pins
Dimension of coordinate axis is only offset without tolerance

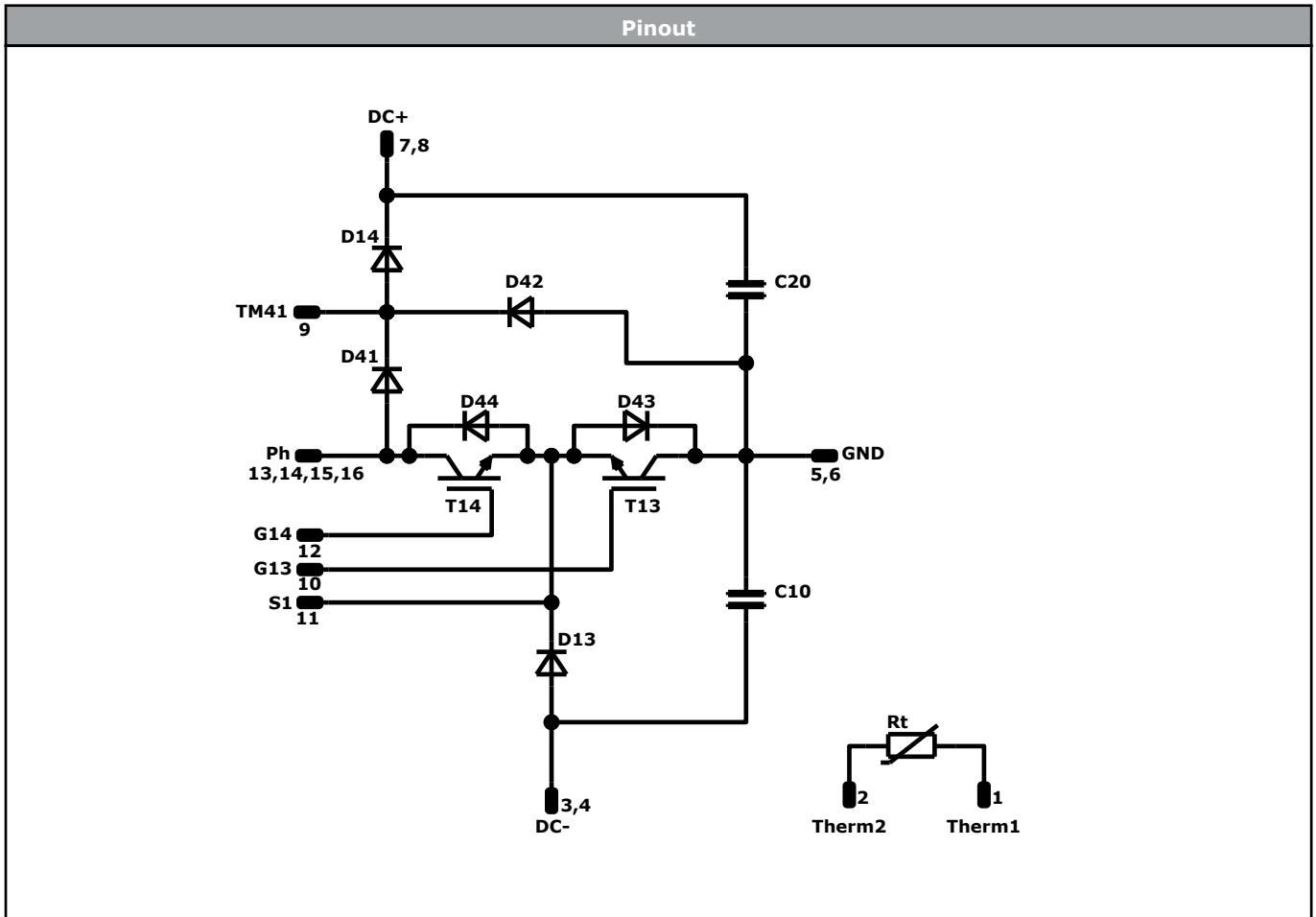

Identification					
ID	Component	Voltage	Current	Function	Comment
T13	IGBT	650 V	100 A	Negative Neutral Point Switch	
T14	IGBT	650 V	100 A	Positive Neutral Point Switch	
D13	FWD	650 V	30 A	Negative Boost Diode	
D14	FWD	650 V	30 A	Positive Boost Diode	
D43	Rectifier	1600 V	60 A	Negative Neutral Point Diode	
D44	Rectifier	1600 V	110 A	Positive Neutral Point Diode	
D42	FWD	650 V	20 A	Positive Boost Diode Protection Diode	
D41	Rectifier	1600 V	60 A	Positive Boost Blocking Diode	
C10, C20	Capacitor	630 V		Capacitor (DC)	
Rt	Thermistor			Thermistor	



Vincotech

Packaging instruction				
Standard packaging quantity (SPQ) 135	>SPQ	Standard	<SPQ	Sample

Handling instruction
Handling instructions for <i>flow 0</i> packages see vincotech.com website.

Package data
Package data for <i>flow 0</i> packages see vincotech.com website.

Vincotech thermistor reference
See Vincotech thermistor reference table at vincotech.com website.

UL recognition and file number
This device is certified according to UL 1557 standard, UL file number E192116. For more information see vincotech.com website. 

Document No.:	Date:	Modification:	Pages
10-PZ07ANA100RG03-LK39L38Y-D1-14	10 Feb. 2022	Initial Release	

DISCLAIMER

The information, specifications, procedures, methods and recommendations herein (together "information") are presented by Vincotech to reader in good faith, are believed to be accurate and reliable, but may well be incomplete and/or not applicable to all conditions or situations that may exist or occur. Vincotech reserves the right to make any changes without further notice to any products to improve reliability, function or design. No representation, guarantee or warranty is made to reader as to the accuracy, reliability or completeness of said information or that the application or use of any of the same will avoid hazards, accidents, losses, damages or injury of any kind to persons or property or that the same will not infringe third parties rights or give desired results. It is reader's sole responsibility to test and determine the suitability of the information and the product for reader's intended use.

LIFE SUPPORT POLICY

Vincotech products are not authorised for use as critical components in life support devices or systems without the express written approval of Vincotech.

As used herein:

1. Life support devices or systems are devices or systems which, (a) are intended for surgical implant into the body, or (b) support or sustain life, or (c) whose failure to perform when properly used in accordance with instructions for use provided in labelling can be reasonably expected to result in significant injury to the user.
2. A critical component is any component of a life support device or system whose failure to perform can be reasonably expected to cause the failure of the life support device or system, or to affect its safety or effectiveness.