

### General Description

- AlphaSGT™ N-Channel Power MOSFET
- Excellent gate charge x  $R_{DS(ON)}$  product (FOM)
- PB-free lead plating, RoHS compliant

### Applications

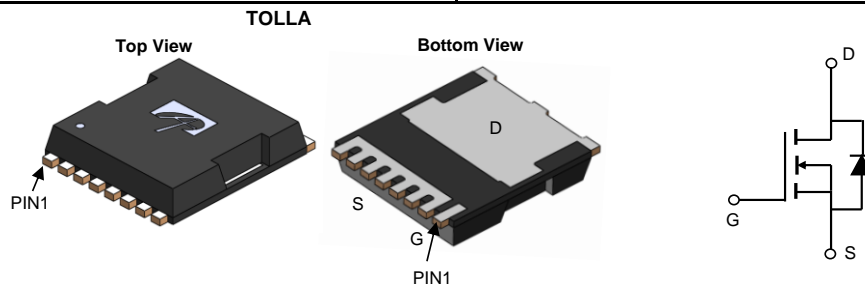
- BLDC Motor Drive
- Battery Management
- Load Switch

### Product Summary

$V_{DS}$	80V
$I_D$ (at $V_{GS}=10V$ )	445A
$R_{DS(ON)}$ (at $V_{GS}=10V$ )	< 1.25m $\Omega$
$R_{DS(ON)}$ (at $V_{GS}=8V$ )	< 1.45m $\Omega$

100% UIS Tested  
 100% Rg Tested

Max  $T_j=175^\circ C$



Orderable Part Number	Package Type	Form	Minimum Order Quantity
AOTL66810Q	TOLLA	Tape & Reel	2000

### Absolute Maximum Ratings $T_A=25^\circ C$ unless otherwise noted

Parameter	Symbol	Maximum	Units
Drain-Source Voltage	$V_{DS}$	80	V
Gate-Source Voltage	$V_{GS}$	$\pm 20$	V
Continuous Drain Current	$I_D$	$T_C=25^\circ C$	445
		$T_C=100^\circ C$	315
Pulsed Drain Current <sup>C</sup> ( $\leq 100\mu S$ )	$I_{DM}$	1780	A
Continuous Drain Current	$I_{DSM}$	$T_A=25^\circ C$	63
		$T_A=70^\circ C$	52
Avalanche Current <sup>C</sup>	$I_{AS}$	80	A
Avalanche energy $L=0.3mH$ <sup>C</sup>	$E_{AS}$	960	mJ
Power Dissipation <sup>B</sup>	$P_D$	$T_C=25^\circ C$	500
		$T_C=100^\circ C$	250
Power Dissipation <sup>A</sup>	$P_{DSM}$	$T_A=25^\circ C$	10
		$T_A=70^\circ C$	7
Junction and Storage Temperature Range	$T_J, T_{STG}$	-55 to 175	$^\circ C$

### Thermal Characteristics

Parameter	Symbol	Typ	Max	Units
Maximum Junction-to-Ambient <sup>A</sup>	$R_{\theta JA}$	10	15	$^\circ C/W$
Maximum Junction-to-Ambient <sup>A D</sup>		Steady-State	35	45
Maximum Junction-to-Case	$R_{\theta JC}$	0.2	0.3	$^\circ C/W$

**Electrical Characteristics (T<sub>J</sub>=25°C unless otherwise noted)**

Symbol	Parameter	Conditions	Min	Typ	Max	Units
<b>STATIC PARAMETERS</b>						
BV <sub>DSS</sub>	Drain-Source Breakdown Voltage	I <sub>D</sub> =250μA, V <sub>GS</sub> =0V	80			V
I <sub>DSS</sub>	Zero Gate Voltage Drain Current	V <sub>DS</sub> =80V, V <sub>GS</sub> =0V T <sub>J</sub> =55°C			1 5	μA
I <sub>GSS</sub>	Gate-Body leakage current	V <sub>DS</sub> =0V, V <sub>GS</sub> =±20V			±100	nA
V <sub>GS(th)</sub>	Gate Threshold Voltage	V <sub>DS</sub> =V <sub>GS</sub> , I <sub>D</sub> =250μA	2.4	3	3.6	V
R <sub>DS(on)</sub>	Static Drain-Source On-Resistance	V <sub>GS</sub> =10V, I <sub>D</sub> =100A T <sub>J</sub> =125°C		1 1.5	1.25 1.9	mΩ
		V <sub>GS</sub> =8V, I <sub>D</sub> =75A		1.1	1.45	mΩ
g <sub>FS</sub>	Forward Transconductance	V <sub>DS</sub> =5V, I <sub>D</sub> =20A		100		S
V <sub>SD</sub>	Diode Forward Voltage	I <sub>S</sub> =1A, V <sub>GS</sub> =0V		0.7	1	V
I <sub>S</sub>	Maximum Body-Diode Continuous Current				200	A
<b>DYNAMIC PARAMETERS</b>						
C <sub>iss</sub>	Input Capacitance	V <sub>GS</sub> =0V, V <sub>DS</sub> =40V, f=1MHz		13000		pF
C <sub>oss</sub>	Output Capacitance			3300		pF
C <sub>rss</sub>	Reverse Transfer Capacitance			60		pF
R <sub>g</sub>	Gate resistance	f=1MHz	1	2	3	Ω
<b>SWITCHING PARAMETERS</b>						
Q <sub>g(10V)</sub>	Total Gate Charge	V <sub>GS</sub> =10V, V <sub>DS</sub> =40V, I <sub>D</sub> =20A		175	245	nC
Q <sub>gs</sub>	Gate Source Charge			50		nC
Q <sub>gd</sub>	Gate Drain Charge			35		nC
Q <sub>oss</sub>	Output Charge	V <sub>GS</sub> =0V, V <sub>DS</sub> =40V		238		nC
t <sub>D(on)</sub>	Turn-On DelayTime	V <sub>GS</sub> =10V, V <sub>DS</sub> =40V, R <sub>L</sub> =2.0Ω, R <sub>GEN</sub> =3Ω		35		ns
t <sub>r</sub>	Turn-On Rise Time			25		ns
t <sub>D(off)</sub>	Turn-Off DelayTime			113		ns
t <sub>f</sub>	Turn-Off Fall Time			39		ns
t <sub>rr</sub>	Body Diode Reverse Recovery Time		I <sub>F</sub> =20A, di/dt=500A/μs		52	
Q <sub>rr</sub>	Body Diode Reverse Recovery Charge	I <sub>F</sub> =20A, di/dt=500A/μs		340		nC

A. The value of R<sub>θJA</sub> is measured with the device mounted on 1in<sup>2</sup> FR-4 board with 2oz. Copper, in a still air environment with T<sub>A</sub>=25° C. The Power dissipation P<sub>DSM</sub> is based on R<sub>θJA</sub> ≤ 10s and the maximum allowed junction temperature of 175° C. The value in any given application depends on the user's specific board design, and the maximum temperature of 175° C may be used if the PCB allows it.

B. The power dissipation P<sub>D</sub> is based on T<sub>J(MAX)</sub>=175° C, using junction-to-case thermal resistance, and is more useful in setting the upper dissipation limit for cases where additional heatsinking is used.

C. Single pulse width limited by junction temperature T<sub>J(MAX)</sub>=175° C.

D. The R<sub>θJA</sub> is the sum of the thermal impedance from junction to case R<sub>θJC</sub> and case to ambient.

E. The static characteristics in Figures 1 to 6 are obtained using <300μs pulses, duty cycle 0.5% max.

F. These curves are based on the junction-to-case thermal impedance which is measured with the device mounted to a large heatsink, assuming a maximum junction temperature of T<sub>J(MAX)</sub>=175° C. The SOA curve provides a single pulse rating.

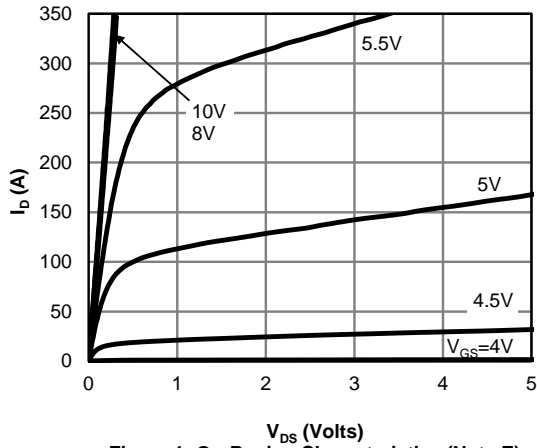
G. These tests are performed with the device mounted on 1 in<sup>2</sup> FR-4 board with 2oz. Copper, in a still air environment with T<sub>A</sub>=25° C.

APPLICATIONS OR USES AS CRITICAL COMPONENTS IN LIFE SUPPORT DEVICES OR SYSTEMS ARE NOT AUTHORIZED. AOS DOES NOT ASSUME ANY LIABILITY ARISING OUT OF SUCH APPLICATIONS OR USES OF ITS PRODUCTS. AOS RESERVES THE RIGHT TO MAKE CHANGES TO PRODUCT SPECIFICATIONS WITHOUT NOTICE. IT IS THE RESPONSIBILITY OF THE CUSTOMER TO EVALUATE SUITABILITY OF THE PRODUCT FOR THEIR INTENDED APPLICATION. CUSTOMER SHALL COMPLY WITH APPLICABLE LEGAL REQUIREMENTS, INCLUDING ALL APPLICABLE EXPORT CONTROL RULES, REGULATIONS AND LIMITATIONS.

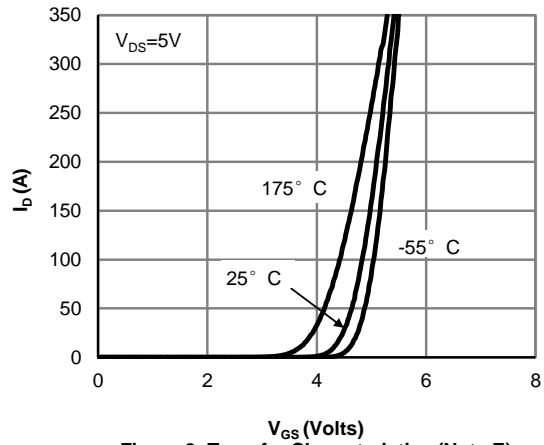
AOS' products are provided subject to AOS' terms and conditions of sale which are set forth at:

[http://www.aosmd.com/terms\\_and\\_conditions\\_of\\_sale](http://www.aosmd.com/terms_and_conditions_of_sale)

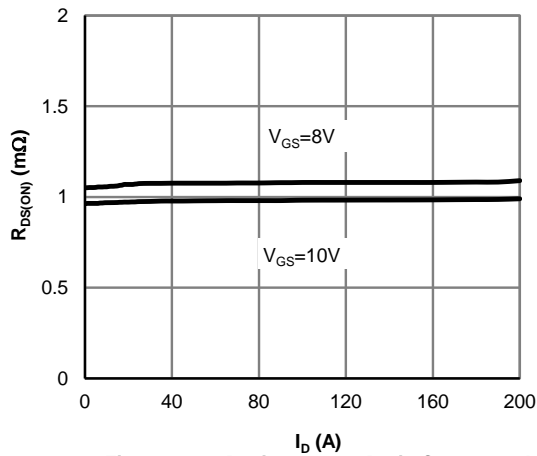
**TYPICAL ELECTRICAL AND THERMAL CHARACTERISTICS**



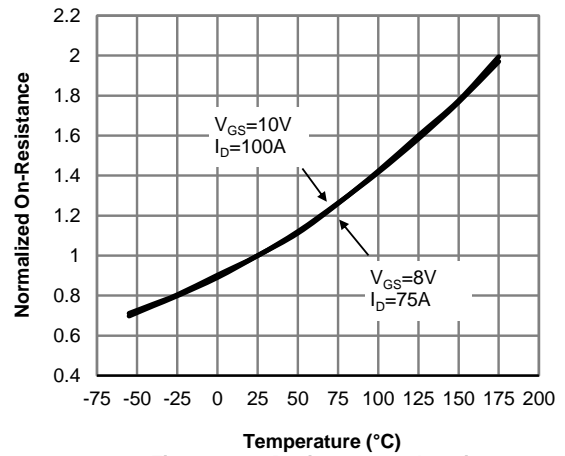
**Figure 1: On-Region Characteristics (Note E)**



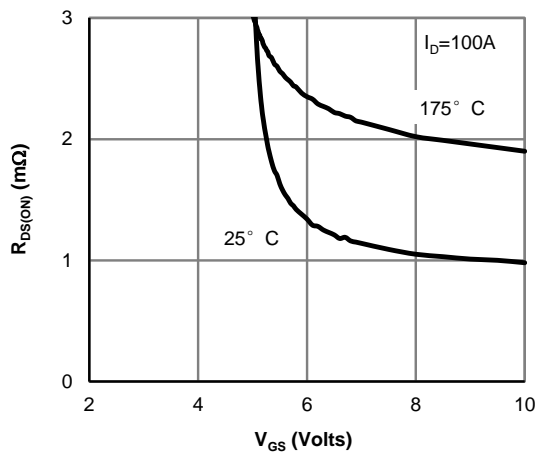
**Figure 2: Transfer Characteristics (Note E)**



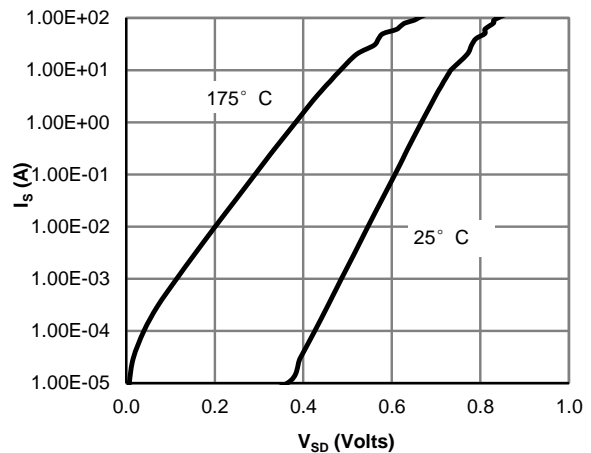
**Figure 3: On-Resistance vs. Drain Current and Gate Voltage (Note E)**



**Figure 4: On-Resistance vs. Junction Temperature (Note E)**

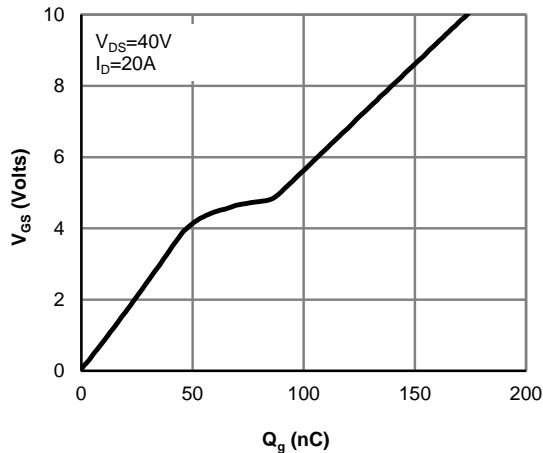


**Figure 5: On-Resistance vs. Gate-Source Voltage (Note E)**

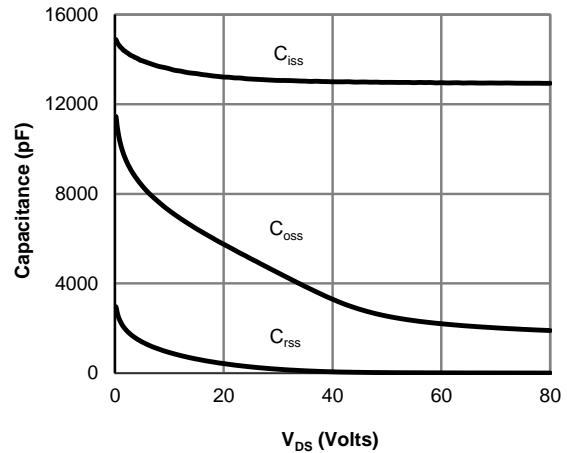


**Figure 6: Body-Diode Characteristics (Note E)**

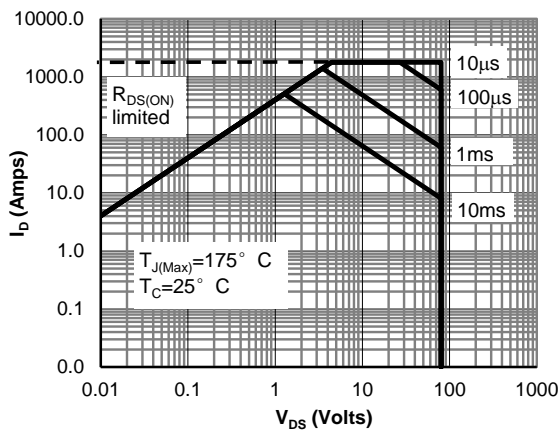
**TYPICAL ELECTRICAL AND THERMAL CHARACTERISTICS**



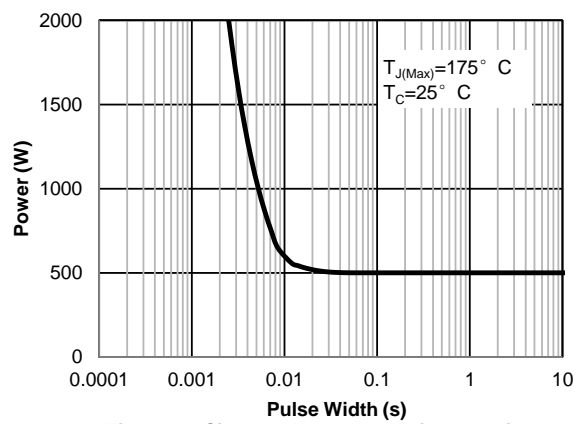
**Figure 7: Gate-Charge Characteristics**



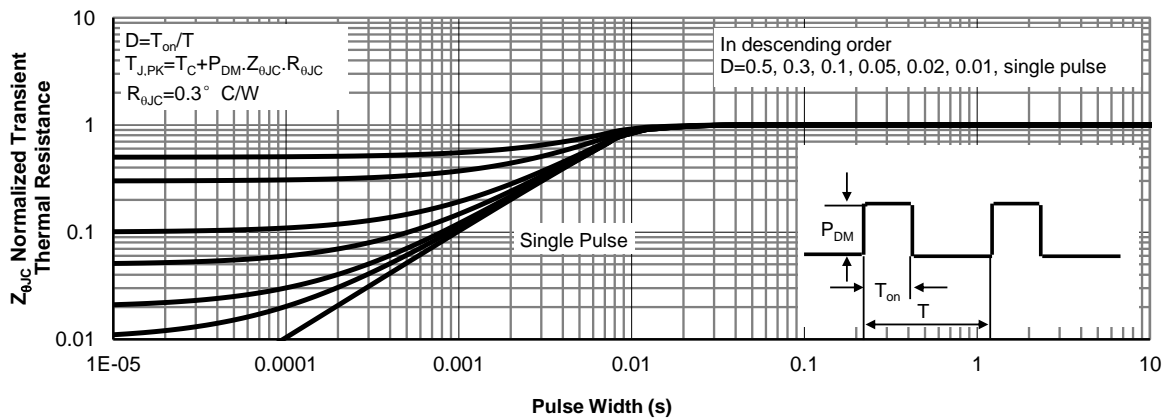
**Figure 8: Capacitance Characteristics**



**Figure 9: Maximum Forward Biased Safe Operating Area (Note F)**



**Figure 10: Single Pulse Power Rating Junction-to-Case (Note F)**



**Figure 11: Normalized Maximum Transient Thermal Impedance (Note F)**

**TYPICAL ELECTRICAL AND THERMAL CHARACTERISTICS**

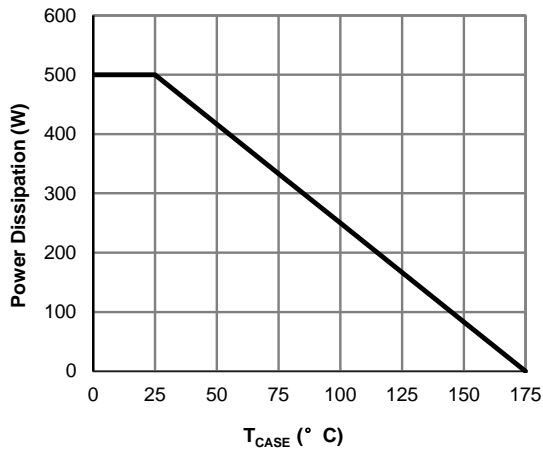


Figure 12: Power De-rating (Note F)

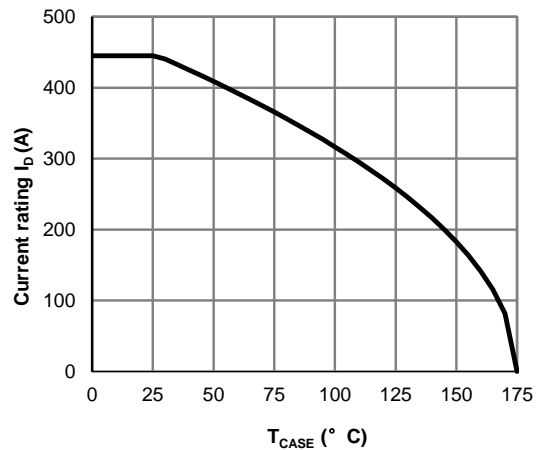


Figure 13: Current De-rating (Note F)

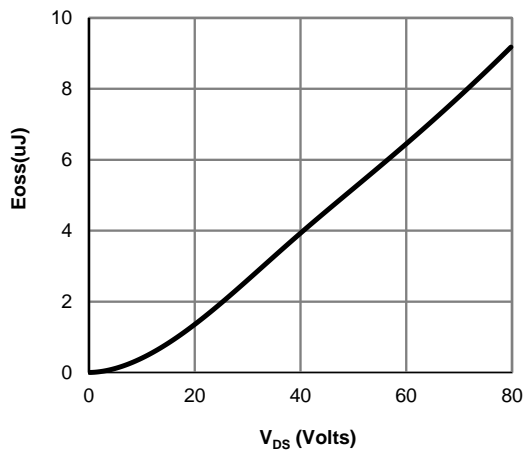


Figure 14: Coss stored Energy

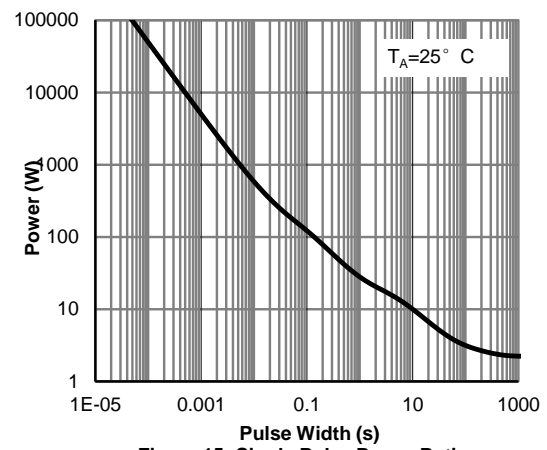


Figure 15: Single Pulse Power Rating Junction-to-Ambient (Note G)

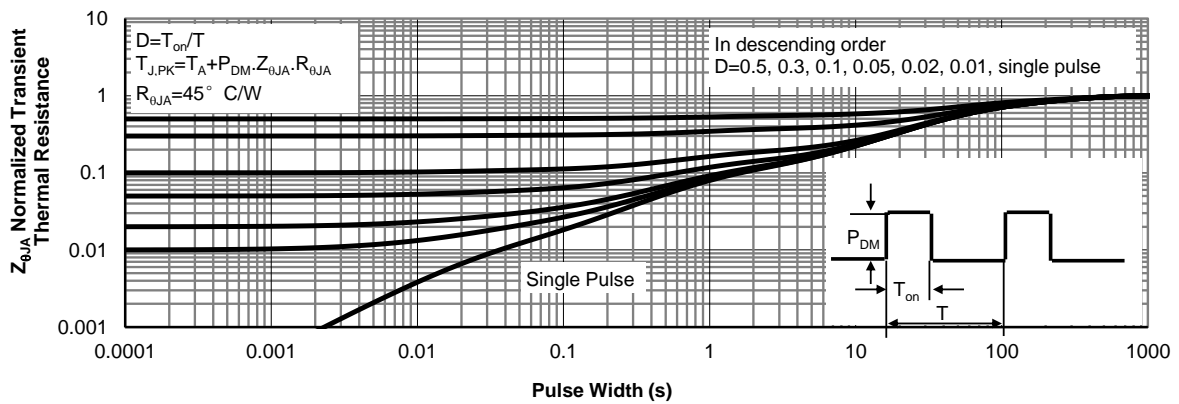


Figure 16: Normalized Maximum Transient Thermal Impedance (Note G)

**TYPICAL ELECTRICAL AND THERMAL CHARACTERISTICS**

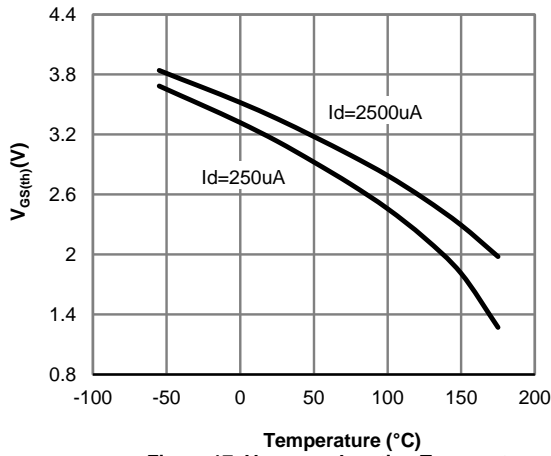


Figure 17:  $V_{GS(th)}$  vs. Junction Temperature

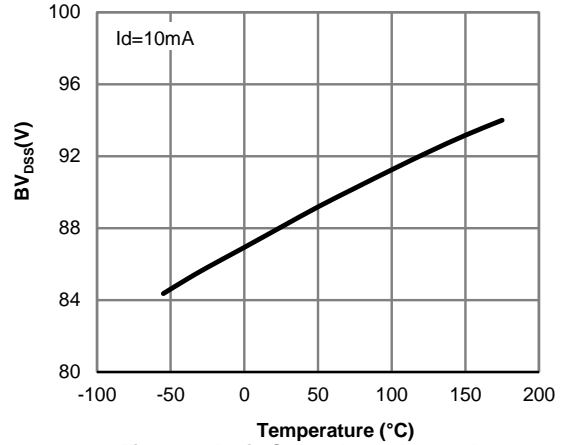


Figure 18: Drain-Source breakdown voltage vs. Junction Temperature

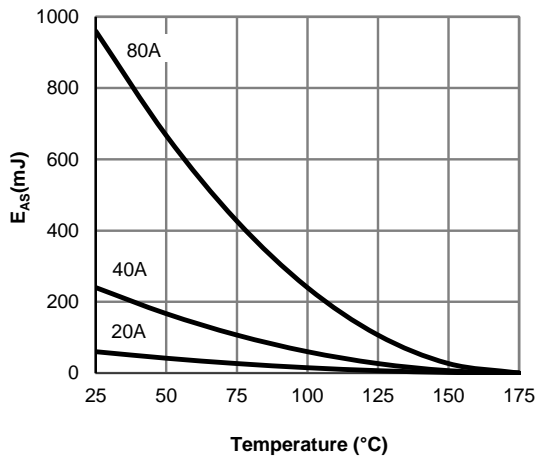


Figure 19: EAS vs. Junction Temperature

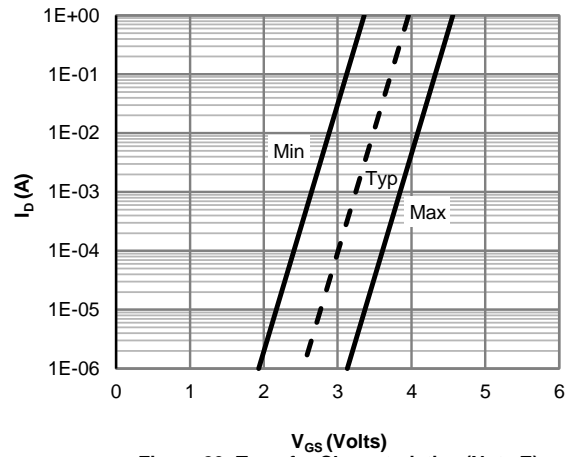


Figure 20: Transfer Characteristics (Note E)

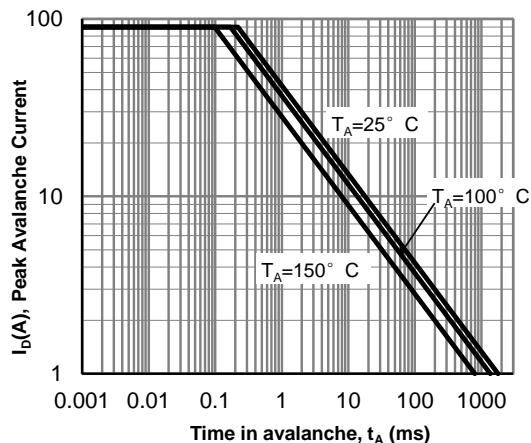


Figure 21: Single Pulse Avalanche capability

Figure A: Gate Charge Test Circuit & Waveforms

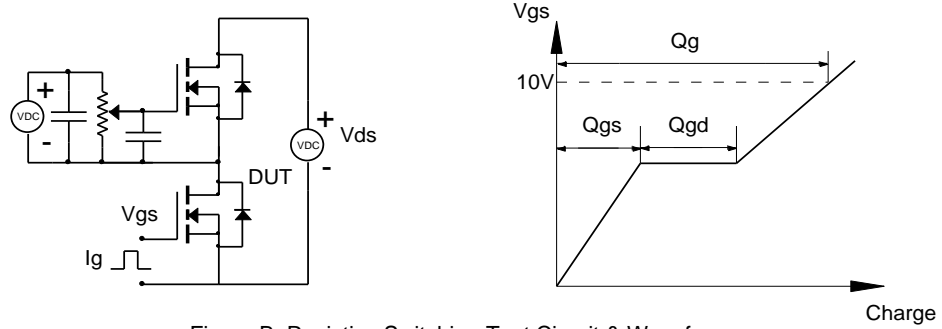


Figure B: Resistive Switching Test Circuit & Waveforms

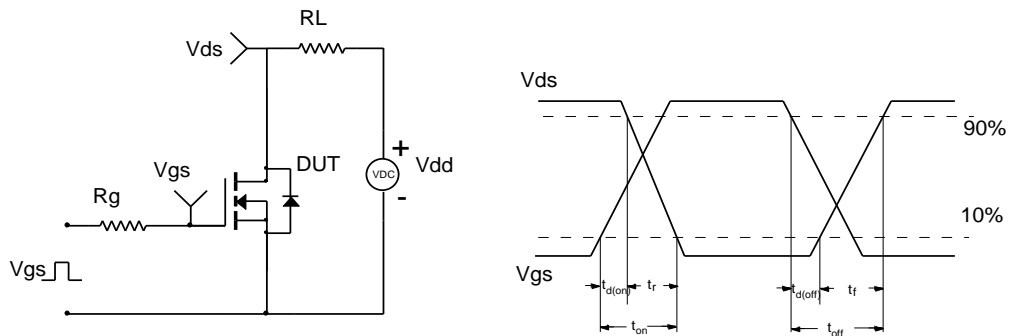


Figure C: Unclamped Inductive Switching (UIS) Test Circuit & Waveforms

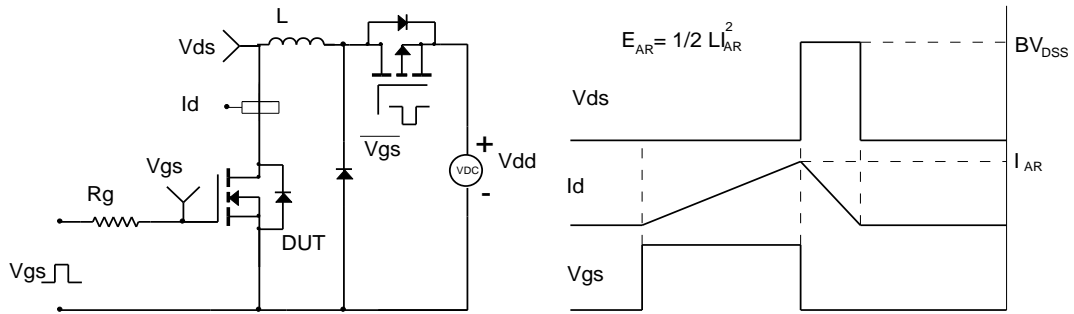


Figure D: Diode Recovery Test Circuit & Waveforms

