



flowPHASE 0 + NTC

1200 V / 100 A

**Topology features**

- Half Bridge
- Temperature sensor

**Component features**

- Easy paralleling
- Low turn-off losses
- Low collector emitter saturation voltage
- Positive temperature coefficient
- Short tail current

**Housing features**

- Base isolation: AlN
- Clip-in, reliable mechanical connection, qualified for wave soldering
- Convex shaped substrate for superior thermal contact
- Thermo-mechanical push-and-pull force relief
- Press-fit pin
- Reliable cold welding connection

**Target applications**

- Industrial Drives
- Power Supply
- Solar Inverters
- UPS
- Welding & Cutting

**Types**

- 10-P0122PB100SC03-M819F19Y

**flow 0 17 mm housing**

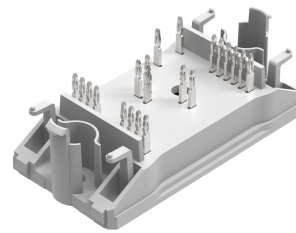

**Schematic**

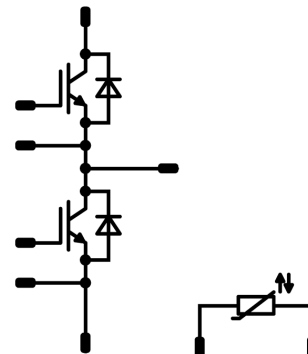



Vincotech

## Maximum Ratings

$T_j = 25\text{ °C}$ , unless otherwise specified

Parameter	Symbol	Conditions	Value	Unit
<b>Half-Bridge Switch</b>				
Collector-emitter voltage	$V_{CES}$		1200	V
Collector current (DC current)	$I_C$	$T_j = T_{jmax}$ $T_s = 80\text{ °C}$	117	A
Repetitive peak collector current	$I_{CRM}$	$t_p$ limited by $T_{jmax}$	300	A
Total power dissipation	$P_{tot}$	$T_j = T_{jmax}$ $T_s = 80\text{ °C}$	268	W
Gate-emitter voltage	$V_{GES}$		$\pm 20$	V
Short circuit ratings	$t_{SC}$	$V_{GE} = 15\text{ V}$ , $V_{CC} = 800\text{ V}$ $T_j = 150\text{ °C}$	10	$\mu\text{s}$
Maximum junction temperature	$T_{jmax}$		175	$^{\circ}\text{C}$

## Half-Bridge Diode

Peak repetitive reverse voltage	$V_{RRM}$		1200	V
Forward current (DC current)	$I_F$	$T_j = T_{jmax}$ $T_s = 80\text{ °C}$	99	A
Repetitive peak forward current	$I_{FRM}$	$t_p$ limited by $T_{jmax}$	200	A
Total power dissipation	$P_{tot}$	$T_j = T_{jmax}$ $T_s = 80\text{ °C}$	172	W
Maximum junction temperature	$T_{jmax}$		175	$^{\circ}\text{C}$

## Module Properties

### Thermal Properties

Storage temperature	$T_{stg}$		-40...+125	$^{\circ}\text{C}$
Operation temperature under switching condition	$T_{jop}$		-40...+( $T_{jmax} - 25$ )	$^{\circ}\text{C}$

### Isolation Properties

Isolation voltage	$V_{isol}$	DC Test Voltage* $t_p = 2\text{ s}$	6000	V
Isolation voltage	$V'_{isol}$	AC Voltage $t_p = 1\text{ min}$	2500	V
Creepage distance			>12,7	mm
Clearance			>12,7	mm
Comparative Tracking Index	CTI		$\geq 200$	

\*100 % tested in production



Vincotech

### Characteristic Values

Parameter	Symbol	Conditions					Values			Unit
		$V_{GS}$ [V]	$V_{GE}$ [V]	$V_{DS}$ [V]	$V_F$ [V]	$I_C$ [A] $I_D$ [A] $I_F$ [A]	$T_j$ [°C]	Min	Typ	

#### Half-Bridge Switch

##### Static

Gate-emitter threshold voltage	$V_{GE(th)}$	$V_{CE} = V_{GE}$				0,0038	25	5,1	5,8	6,4	V
Collector-emitter saturation voltage	$V_{CE(sat)}$		15			100	25 125 150	1,53	1,72 1,97	1,97 <sup>(1)</sup>	V
Collector-emitter cut-off current	$I_{CES}$		0	1200			25			1,3	μA
Gate-emitter leakage current	$I_{GES}$		20	0			25			120	nA
Internal gate resistance	$r_g$								7,5		Ω
Input capacitance	$C_{ies}$								6300		pF
Reverse transfer capacitance	$C_{res}$	$f = 1 \text{ Mhz}$	0	25			25		270		pF
Gate charge	$Q_g$		±15			0	25		800		nC

##### Thermal

Thermal resistance junction to sink <sup>(2)</sup>	$R_{th(j-s)}$	$\lambda_{foil} = 220 \text{ W/mK}$ (KU-ALF5)							0,35		K/W
--	---------------	--	--	--	--	--	--	--	------	--	-----

##### Dynamic

Turn-on delay time	$t_{d(on)}$						25 125		170,6 183,8		ns
Rise time	$t_r$						25 125		32,8 37		ns
Turn-off delay time	$t_{d(off)}$						25 125		292,8 365		ns
Fall time	$t_f$						25 125		59,82 121,28		ns
Turn-on energy (per pulse)	$E_{on}$	$Q_{tFWD} = 9,06 \mu\text{C}$ $Q_{tFWD} = 16,84 \mu\text{C}$					25 125		6,9 10,14		mWs
Turn-off energy (per pulse)	$E_{off}$						25 125		6,26 9,37		mWs



Vincotech

### Characteristic Values

Parameter	Symbol	Conditions					Values			Unit
		$V_{GS}$ [V]	$V_{GE}$ [V]	$V_{DS}$ [V]	$V_{CE}$ [V]	$T_j$ [°C]	Min	Typ	Max	

#### Half-Bridge Diode

##### Static

Forward voltage	$V_F$				100	25 125 150	1,35	1,77 1,75 1,73	2,05 <sup>(1)</sup>	V
Reverse leakage current	$I_R$	$V_T = 1200$ V				25			18	μA

##### Thermal

Thermal resistance junction to sink <sup>(2)</sup>	$R_{th(j-s)}$	$\lambda_{foil}=220$ W/mK (KU-ALF5)						0,55		K/W
--	---------------	--	--	--	--	--	--	------	--	-----

##### Dynamic

Peak recovery current	$I_{RRM}$	$di/dt=3987$ A/μs $di/dt=3060$ A/μs	±15	600	100	25		103,62		A
						125		119,41		
Reverse recovery time	$t_{rr}$					25		247,41		
						125		391,68		
Recovered charge	$Q_r$					25		9,06		
		125		16,84						
Reverse recovered energy	$E_{rec}$	25		3,24						
		125		6,3						
Peak rate of fall of recovery current	$(di_{rr}/dt)_{max}$	25		3017						
		125		1630						



Vincotech

### Characteristic Values

Parameter	Symbol	Conditions					Values			Unit	
		$V_{GS}$ [V]	$V_{GE}$ [V]	$V_{DS}$ [V]	$V_{CE}$ [V]	$V_F$ [V]	$I_D$ [A]	$I_C$ [A]	$I_F$ [A]		$T_j$ [°C]

### Thermistor

#### Static

Rated resistance	$R$					25		22		k $\Omega$
Deviation of $R_{100}$	$A_{R/R}$	$R_{100} = 1484 \Omega$				100	-5		5	%
Power dissipation	$P$					25		130		mW
Power dissipation constant	$d$					25		1,5		mW/K
B-value	$B_{(25/50)}$	Tol. $\pm 1$ %						3962		K
B-value	$B_{(25/100)}$	Tol. $\pm 1$ %						4000		K
Vincotech Thermistor Reference									I	

<sup>(1)</sup> Value at chip level

<sup>(2)</sup> Only valid with pre-applied Vincotech thermal interface material.



## Half-Bridge Switch Characteristics

**figure 1.** IGBT

Typical output characteristics

$$I_C = f(V_{CE})$$

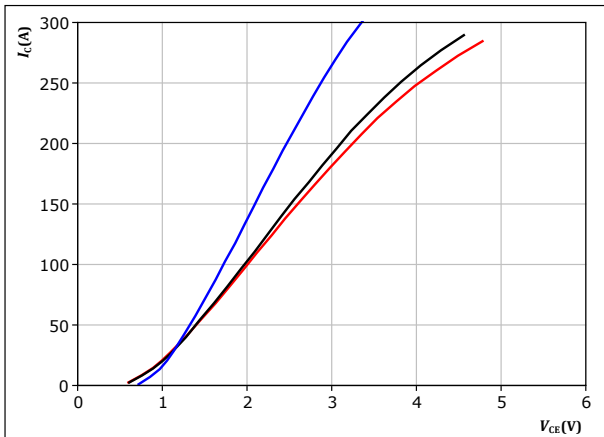

$t_p = 250 \mu s$   
 $V_{GE} = 15 V$   
 $T_j:$  — 25 °C  
— 125 °C  
— 150 °C

**figure 2.** IGBT

Typical output characteristics

$$I_C = f(V_{CE})$$

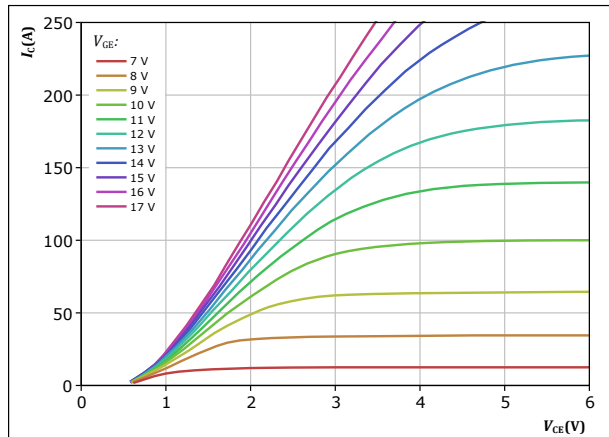

$t_p = 250 \mu s$   
 $T_j = 150 \text{ °C}$   
 $V_{GE}$  from 7 V to 17 V in steps of 1 V

**figure 3.** IGBT

Typical transfer characteristics

$$I_C = f(V_{GE})$$

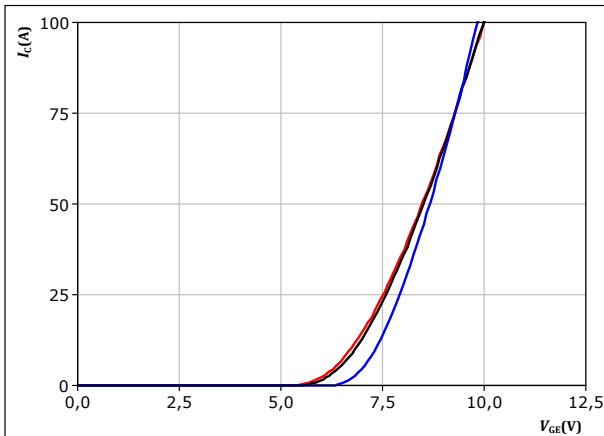

$t_p = 250 \mu s$   
 $V_{CE} = 10 V$   
 $T_j:$  — 25 °C  
— 125 °C  
— 150 °C

**figure 4.** IGBT

Transient thermal impedance as a function of pulse width

$$Z_{th(j-s)} = f(t_p)$$

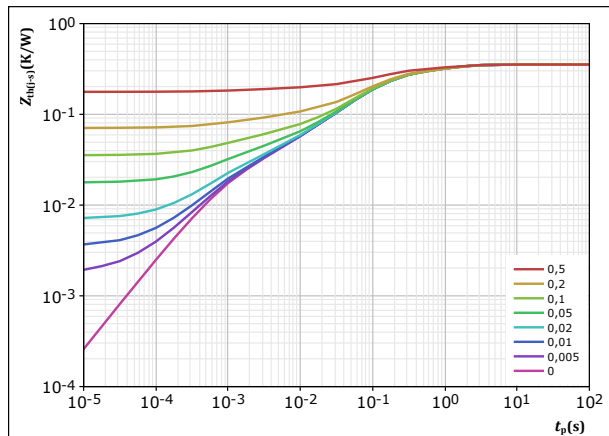

$D = t_p / T$   
 $R_{th(j-s)} = 0,354 \text{ K/W}$   
IGBT thermal model values

$R$ (K/W)	$\tau$ (s)
8,18E-02	1,14E+00
1,49E-01	1,50E-01
8,74E-02	5,52E-02
1,88E-02	5,39E-03
1,69E-02	8,48E-04



Vincotech

## Half-Bridge Switch Characteristics

figure 5. IGBT

Safe operating area

$$I_C = f(V_{CE})$$

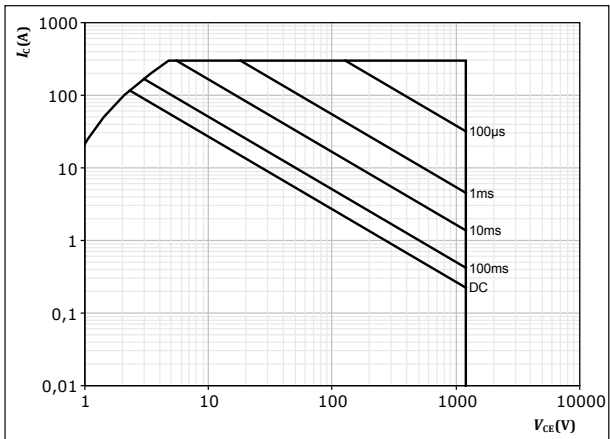

$D =$  single pulse

$T_s = 80$  °C

$V_{CE} = 15$  V

$T_j = T_{jmax}$



## Half-Bridge Diode Characteristics

figure 6. FWD

Typical forward characteristics

$$I_F = f(V_F)$$

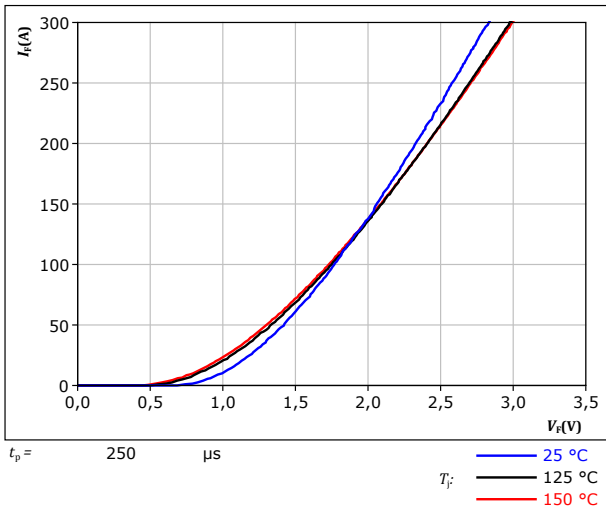
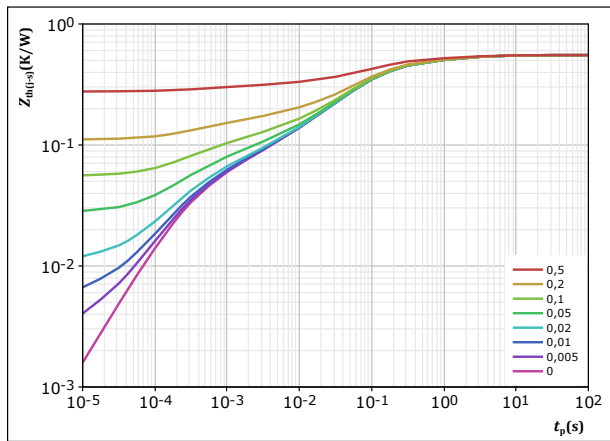

figure 7. FWD

Transient thermal impedance as a function of pulse width

$$Z_{th(j-s)} = f(t_p)$$



$D = \frac{t_p}{T}$   
 $R_{th(j-s)} = 0,553 \text{ K/W}$

FWD thermal model values

$R \text{ (K/W)}$	$\tau \text{ (s)}$
3,57E-02	4,03E+00
7,05E-02	8,06E-01
1,67E-01	1,44E-01
1,68E-01	5,25E-02
4,43E-02	9,00E-03
3,16E-02	1,49E-03
3,63E-02	2,78E-04





## Thermistor Characteristics

figure 8. Thermistor

Typical NTC characteristic as function of temperature

$$R_T = f(T)$$

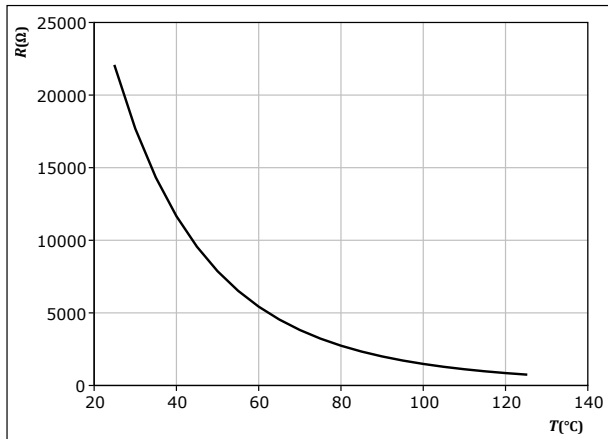



## Half-Bridge Switching Characteristics

**figure 9.** IGBT

Typical switching energy losses as a function of collector current  
 $E = f(I_c)$

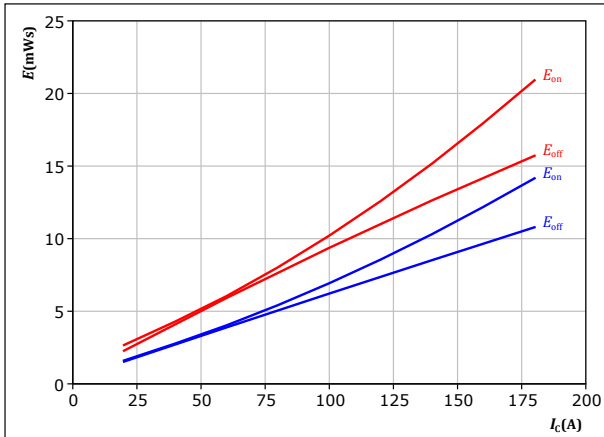

With an inductive load at

$V_{CE} = 600$  V  
 $V_{GE} = \pm 15$  V  
 $R_{gon} = 4$   $\Omega$   
 $R_{goff} = 4$   $\Omega$

$T_j$ : — 25 °C  
 — 125 °C

**figure 10.** IGBT

Typical switching energy losses as a function of IGBT turn on gate resistor  
 $E = f(R_g)$

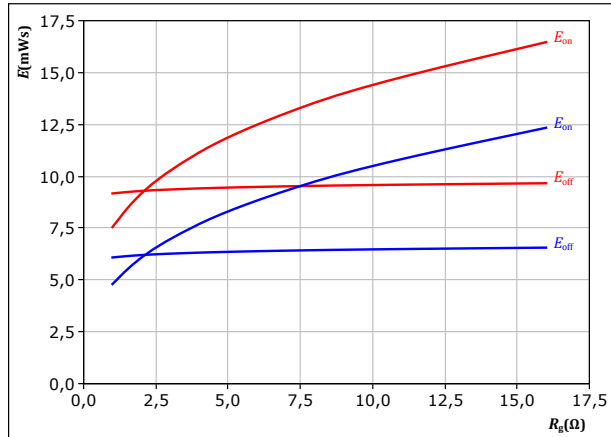

With an inductive load at

$V_{CE} = 600$  V  
 $V_{GE} = \pm 15$  V  
 $I_c = 100$  A

$T_j$ : — 25 °C  
 — 125 °C

**figure 11.** FWD

Typical reverse recovered energy loss as a function of collector current  
 $E_{rec} = f(I_c)$

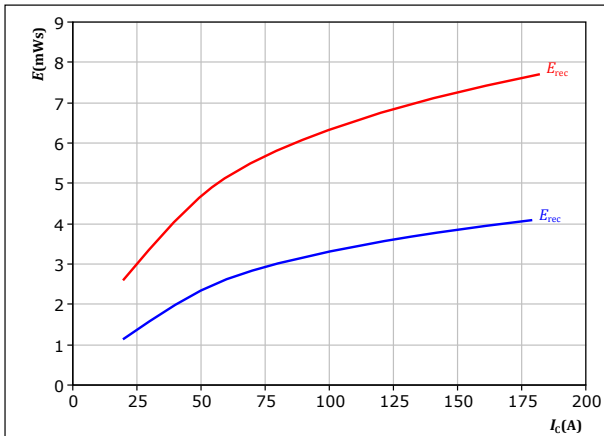

With an inductive load at

$V_{CE} = 600$  V  
 $V_{GE} = \pm 15$  V  
 $R_{gon} = 4$   $\Omega$

$T_j$ : — 25 °C  
 — 125 °C

**figure 12.** FWD

Typical reverse recovered energy loss as a function of IGBT turn on gate resistor  
 $E_{rec} = f(R_g)$

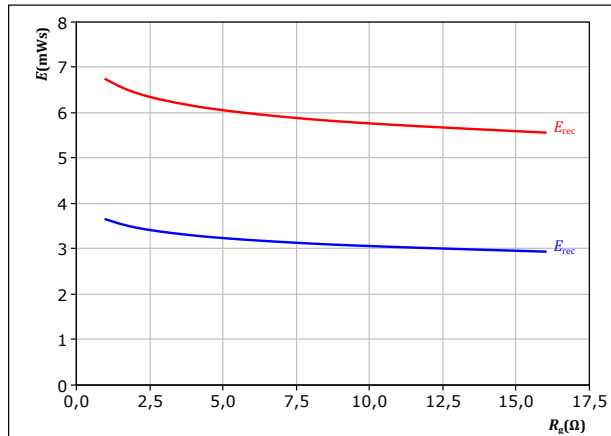

With an inductive load at

$V_{CE} = 600$  V  
 $V_{GE} = \pm 15$  V  
 $I_c = 100$  A

$T_j$ : — 25 °C  
 — 125 °C



## Half-Bridge Switching Characteristics

**figure 13.** IGBT

Typical switching times as a function of collector current  
 $t = f(I_c)$

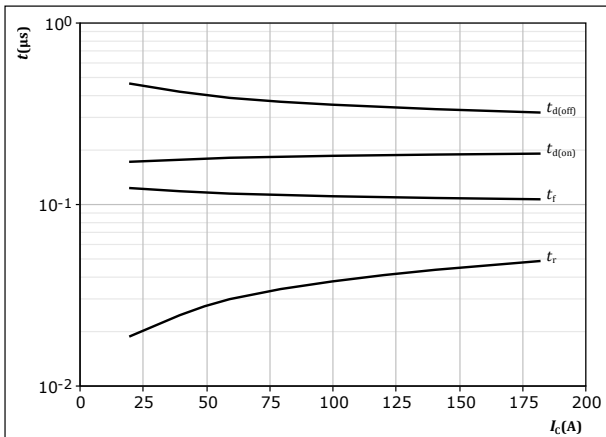

With an inductive load at  
 $T_j = 125 \text{ }^\circ\text{C}$   
 $V_{CE} = 600 \text{ V}$   
 $V_{GE} = \pm 15 \text{ V}$   
 $R_{gon} = 4 \text{ } \Omega$   
 $R_{goff} = 4 \text{ } \Omega$

**figure 14.** IGBT

Typical switching times as a function of IGBT turn on gate resistor  
 $t = f(R_g)$

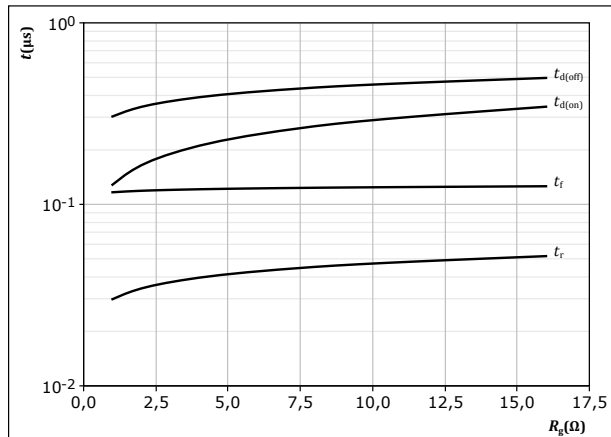

With an inductive load at  
 $T_j = 125 \text{ }^\circ\text{C}$   
 $V_{CE} = 600 \text{ V}$   
 $V_{GE} = \pm 15 \text{ V}$   
 $I_c = 100 \text{ A}$

**figure 15.** FWD

Typical reverse recovery time as a function of collector current  
 $t_{rr} = f(I_c)$

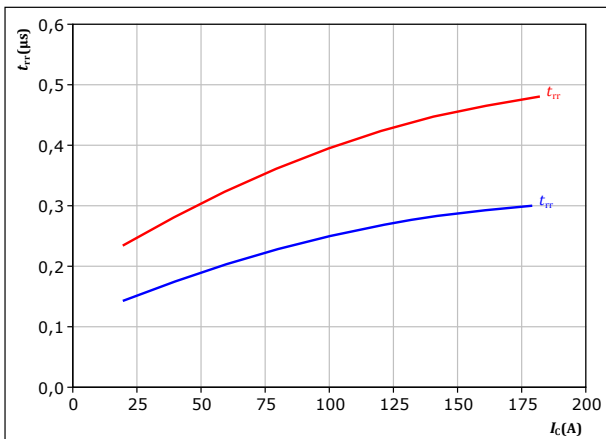

With an inductive load at  
 $V_{CE} = 600 \text{ V}$   
 $V_{GE} = \pm 15 \text{ V}$   
 $R_{gon} = 4 \text{ } \Omega$   
 $T_j$ : — 25 °C  
— 125 °C

**figure 16.** FWD

Typical reverse recovery time as a function of IGBT turn on gate resistor  
 $t_{rr} = f(R_{gon})$

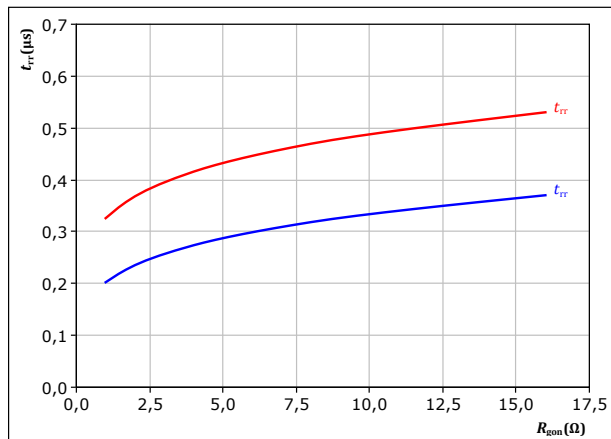

With an inductive load at  
 $V_{CE} = 600 \text{ V}$   
 $V_{GE} = \pm 15 \text{ V}$   
 $I_c = 100 \text{ A}$   
 $T_j$ : — 25 °C  
— 125 °C



## Half-Bridge Switching Characteristics

**figure 17.** FWD

Typical recovered charge as a function of collector current

$$Q_r = f(I_c)$$

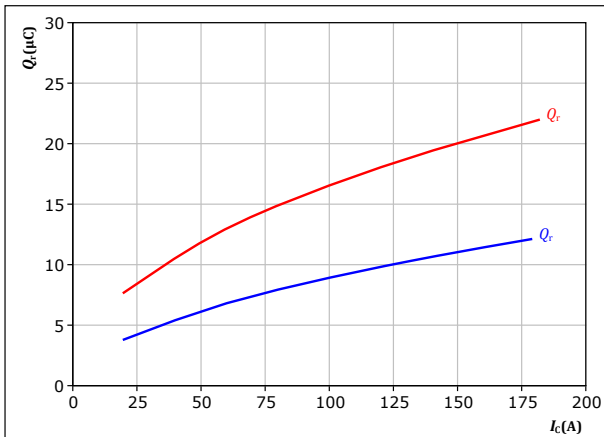

With an inductive load at

$V_{CE} = 600$  V  
 $V_{GE} = \pm 15$  V  
 $R_{gon} = 4$  Ω

$T_j$ : — 25 °C  
— 125 °C

**figure 18.** FWD

Typical recovered charge as a function of IGBT turn on gate resistor

$$Q_r = f(R_{gon})$$

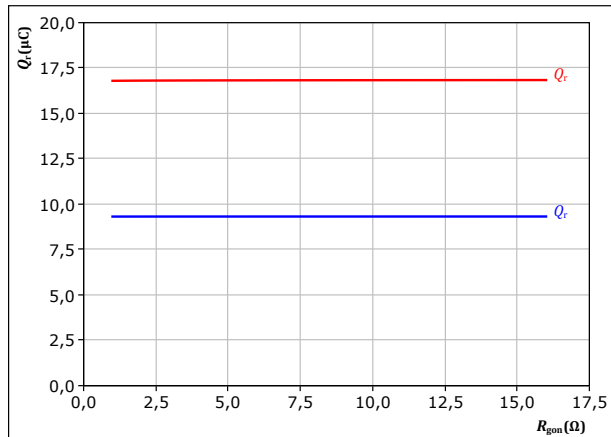

With an inductive load at

$V_{CE} = 600$  V  
 $V_{GE} = \pm 15$  V  
 $I_c = 100$  A

$T_j$ : — 25 °C  
— 125 °C

**figure 19.** FWD

Typical peak reverse recovery current as a function of collector current

$$I_{RM} = f(I_c)$$

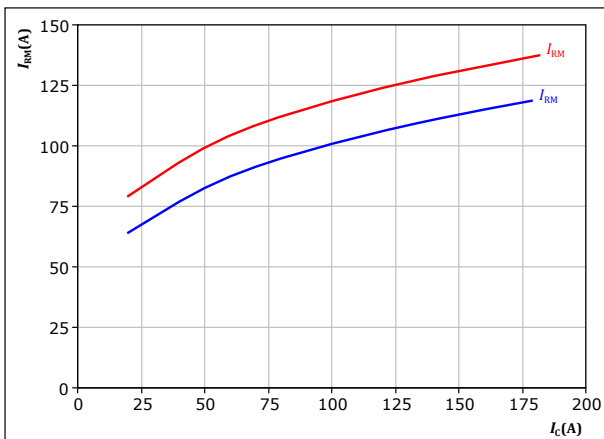

With an inductive load at

$V_{CE} = 600$  V  
 $V_{GE} = \pm 15$  V  
 $R_{gon} = 4$  Ω

$T_j$ : — 25 °C  
— 125 °C

**figure 20.** FWD

Typical peak reverse recovery current as a function of IGBT turn on gate resistor

$$I_{RM} = f(R_{gon})$$

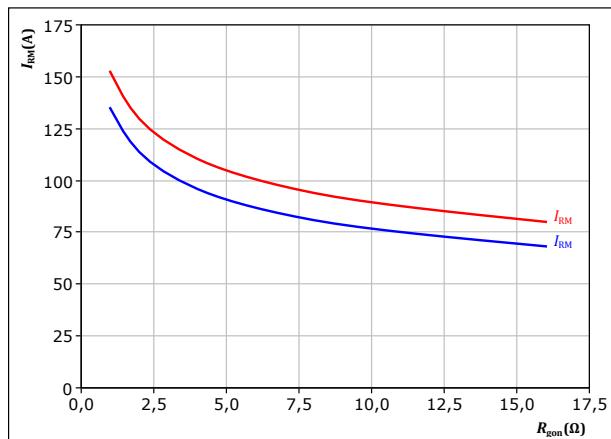

With an inductive load at

$V_{CE} = 600$  V  
 $V_{GE} = \pm 15$  V  
 $I_c = 100$  A

$T_j$ : — 25 °C  
— 125 °C



## Half-Bridge Switching Characteristics

**figure 21.** FWD

Typical rate of fall of forward and reverse recovery current as a function of collector current  
 $di_f/dt, di_r/dt = f(I_C)$

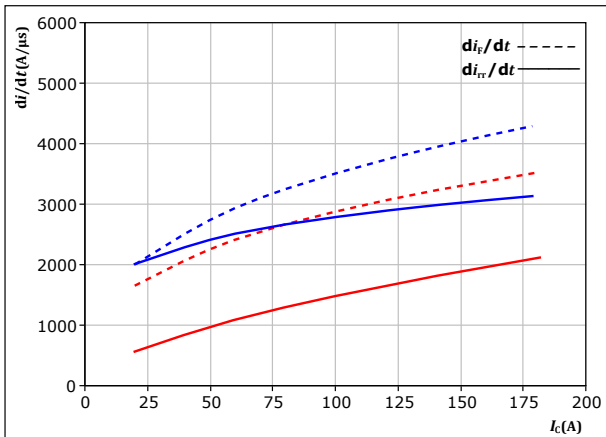

With an inductive load at

$V_{CE} = 600 \text{ V}$   
 $V_{GE} = \pm 15 \text{ V}$   
 $R_{gon} = 4 \ \Omega$

$T_j$ : — 25 °C  
 — 125 °C

**figure 22.** FWD

Typical rate of fall of forward and reverse recovery current as a function of turn on gate resistor  
 $di_f/dt, di_r/dt = f(R_{gon})$

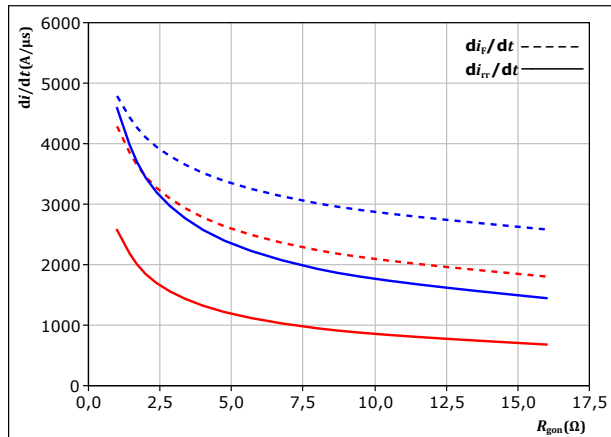

With an inductive load at

$V_{CE} = 600 \text{ V}$   
 $V_{GE} = \pm 15 \text{ V}$   
 $I_C = 100 \text{ A}$

$T_j$ : — 25 °C  
 — 125 °C

**figure 23.** IGBT

Reverse bias safe operating area

$I_C = f(V_{CE})$

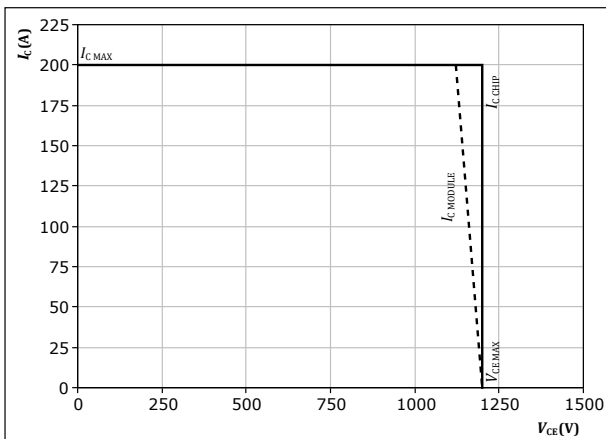

At  $T_j = 125 \text{ °C}$   
 $R_{gon} = 4 \ \Omega$   
 $R_{goff} = 4 \ \Omega$



## Half-Bridge Switching Definitions

**figure 24.** IGBT

Turn-off Switching Waveforms & definition of  $t_{doff}$ ,  $t_{Eoff}$  ( $t_{Eoff}$  = integrating time for  $E_{off}$ )

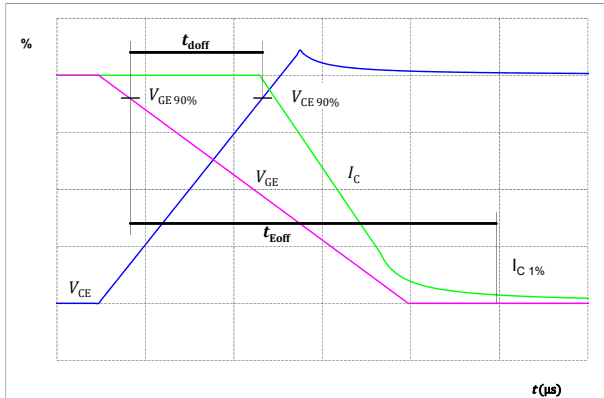

**figure 25.** IGBT

Turn-on Switching Waveforms & definition of  $t_{don}$ ,  $t_{Eon}$  ( $t_{Eon}$  = integrating time for  $E_{on}$ )

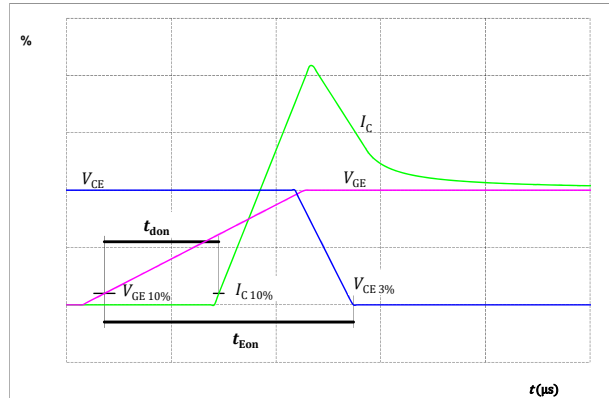

**figure 26.** IGBT

Turn-off Switching Waveforms & definition of  $t_f$

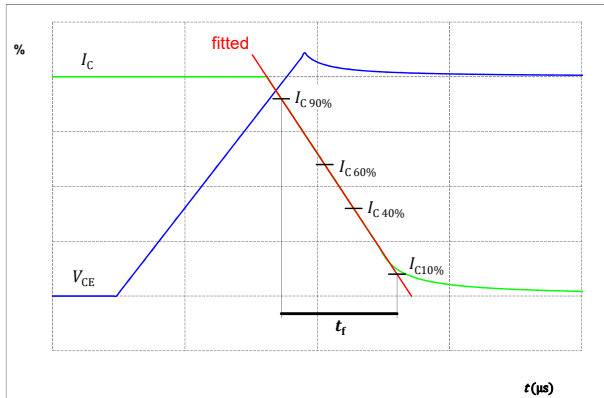

**figure 27.** IGBT

Turn-on Switching Waveforms & definition of  $t_r$

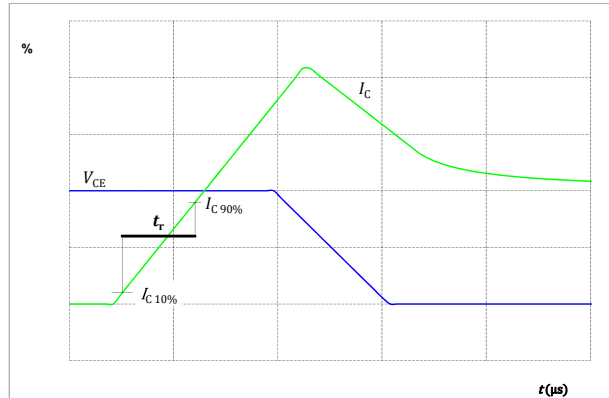



### Half-Bridge Switching Definitions

figure 28. FWD

Turn-off Switching Waveforms & definition of  $t_{rr}$

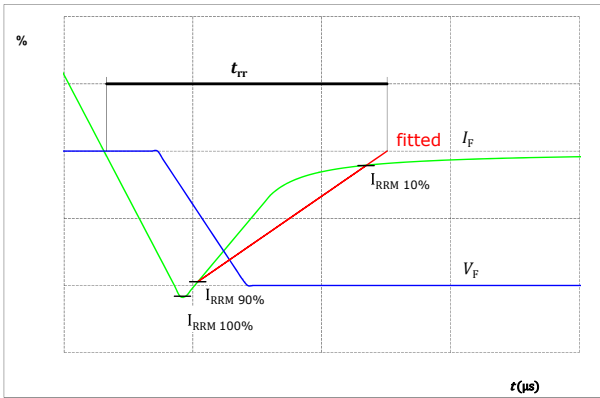
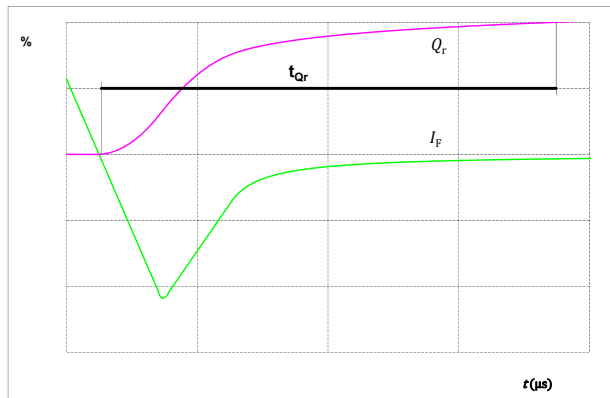

figure 29. FWD

Turn-on Switching Waveforms & definition of  $t_{Qr}$  ( $t_{Qr}$  = integrating time for  $Q_r$ )





Vincotech

**10-P0122PB100SC03-M819F19Y**  
datasheet

Ordering Code	
<b>Version</b>	<b>Ordering Code</b>
Without thermal paste	10-P0122PB100SC03-M819F19Y

Marking						
	<b>Text</b>	<b>Name</b> NN-NNNNNNNNNNNNNNNN- TTTTIV	<b>Date code</b> WWYY	<b>UL &amp; VIN</b> UL VIN	<b>Lot</b> LLLLL	<b>Serial</b> SSSS
	<b>Datamatrix</b>	<b>Type&amp;Ver</b> TTTTIV	<b>Lot number</b> LLLLL	<b>Serial</b> SSSS	<b>Date code</b> WWYY	

Pin table [mm]			
Pin	X	Y	Function
1	0	0	DC-
2	0	2,3	DC-
3	0	4,6	DC-
4	0	6,9	DC-
5	0	15,6	DC+
6	0	17,9	DC+
7	0	20,2	DC+
8	0	22,5	DC+
9	13,85	16,45	G12
10	16,75	16,45	S12
11	33,5	11,5	Ph
12	33,5	9,2	Ph
13	33,5	6,9	Ph
14	33,5	4,6	Ph
15	33,5	2,3	Ph
16	33,5	0	Ph
17	13,85	13,55	Ph
18	19,55	4,95	S11
19	19,55	7,85	G11
20	33,5	22,5	Therm1
21	26,1	22,5	Therm2

**Outline**

Tolerance of pinpositions: ±0.5mm at the end of pins  
Dimension of coordinate axis is only offset without tolerance





Vincotech

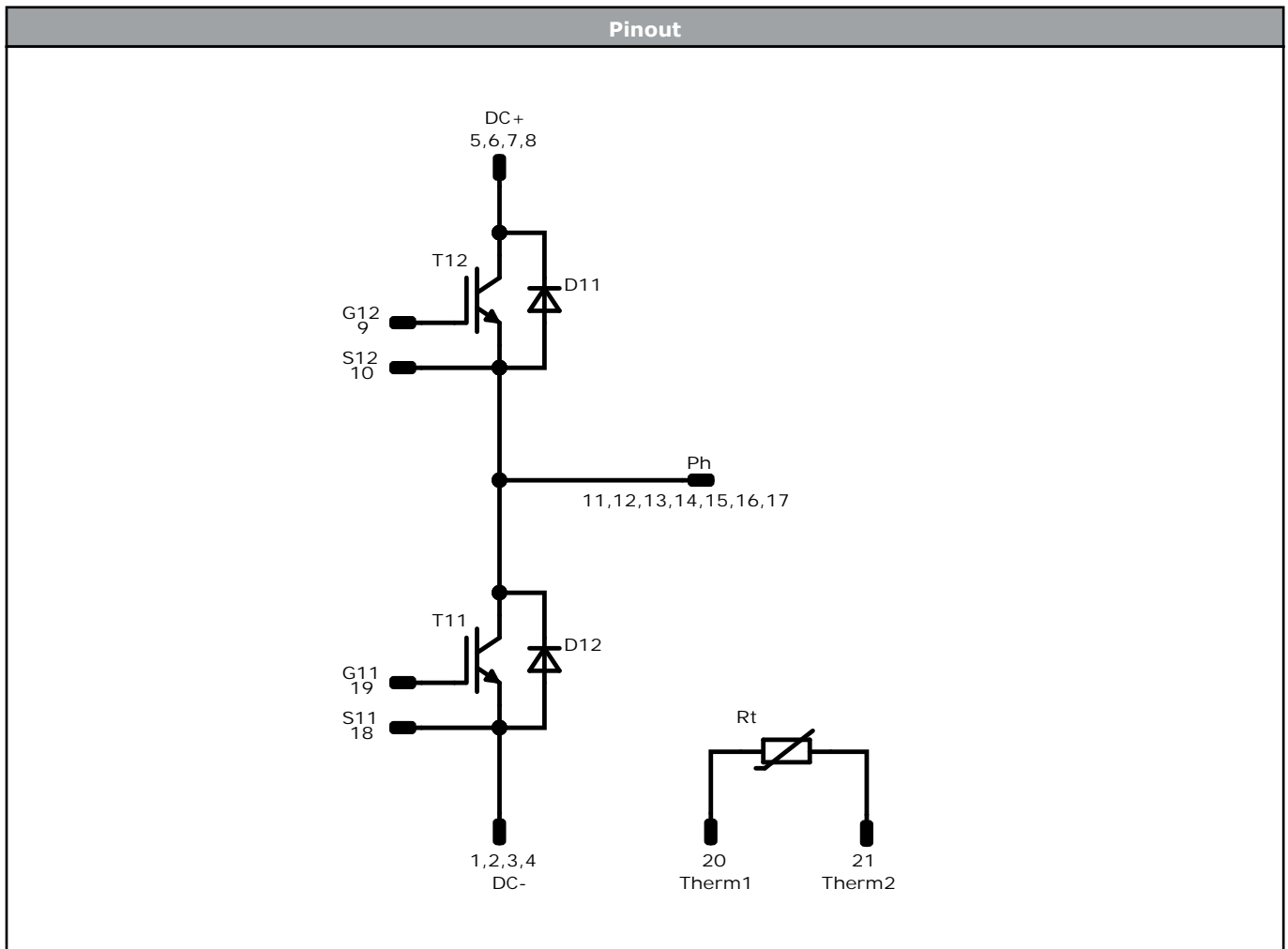

Identification					
ID	Component	Voltage	Current	Function	Comment
T2, T1	IGBT	1200 V	100 A	Half-Bridge Switch	
D1, D2	FWD	1200 V	100 A	Half-Bridge Diode	
Rt	Thermistor			Thermistor	



Packaging instruction				
Standard packaging quantity (SPQ) 135	>SPQ	Standard	<SPQ	Sample

Handling instruction
Handling instructions for <i>flow 0</i> packages see vincotech.com website.

Package data
Package data for <i>flow 0</i> packages see vincotech.com website.

Vincotech thermistor reference
See Vincotech thermistor reference table at vincotech.com website.

UL recognition and file number
This device is certified according to UL 1557 standard, UL file number E192116. For more information see vincotech.com website. 

Document No.:	Date:	Modification:	Pages
10-P0122PB100SC03-M819F19Y-D2-14	5 May. 2022	New Datasheet format, module is unchanged	

**DISCLAIMER**

The information, specifications, procedures, methods and recommendations herein (together "information") are presented by Vincotech to reader in good faith, are believed to be accurate and reliable, but may well be incomplete and/or not applicable to all conditions or situations that may exist or occur. Vincotech reserves the right to make any changes without further notice to any products to improve reliability, function or design. No representation, guarantee or warranty is made to reader as to the accuracy, reliability or completeness of said information or that the application or use of any of the same will avoid hazards, accidents, losses, damages or injury of any kind to persons or property or that the same will not infringe third parties rights or give desired results. It is reader's sole responsibility to test and determine the suitability of the information and the product for reader's intended use.

**LIFE SUPPORT POLICY**

Vincotech products are not authorised for use as critical components in life support devices or systems without the express written approval of Vincotech.

As used herein:

1. Life support devices or systems are devices or systems which, (a) are intended for surgical implant into the body, or (b) support or sustain life, or (c) whose failure to perform when properly used in accordance with instructions for use provided in labelling can be reasonably expected to result in significant injury to the user.
2. A critical component is any component of a life support device or system whose failure to perform can be reasonably expected to cause the failure of the life support device or system, or to affect its safety or effectiveness.