

V_{DS}	1200 V
$R_{DS,on}$	77 m Ω
$I_D (T_C=25^\circ C)$	27 A
$T_{J,max}$	175 $^\circ C$

1200V SiC Full-Bridge Module

Features

- High speed switching SiC MOSFETs
- Reliable body diode
- All parts tested to above 1350V
- Kelvin reference for stable operation
- Press fit terminal connections

Benefits

- Low switching losses
- Low junction to case thermal resistance
- Very rugged and easy mounting
- Direct mounting to heatsink (isolated package)

Applications

- Photovoltaic Inverter
- Battery charger
- Energy storage system
- High voltage DC to DC converter

Package

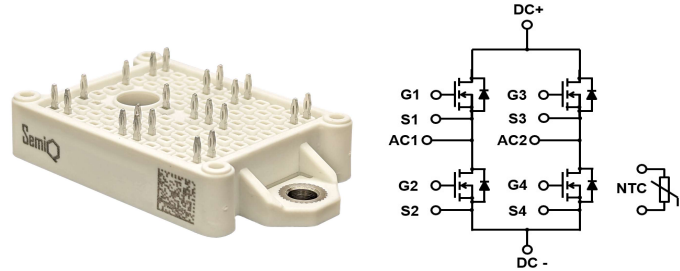

Part #	Package	Marking
GCMX080A120B2H1P	B2	GCMX080A120B2H1P



Absolute Maximum Ratings, at $T_J=25^\circ C$, unless otherwise specified

Characteristics	Symbol	Conditions	Values	Unit
Drain-Source Voltage	V_{rated}	$V_{GS}=0V, I_D=1\mu A$	1200	V
Continuous Drain Current	I_{DS}	$T_C=25^\circ C, V_{GS}=20V, T_J=175^\circ C$	27	A
		$T_C=65^\circ C, V_{GS}=20V, T_J=175^\circ C$	23	
Body Diode Drain Current	I_{SD}	$T_C=25^\circ C, V_{GS}=-5V, T_J=175^\circ C$	33	
Pulsed Drain Current	$I_{DS,pulse}$	$T_C=25^\circ C, V_{GS}=20V$	80	
Gate Source Voltage	V_{GSmax}		-10/25	V
	V_{GSop}	Recommended operational	-5/20	
Power Dissipation	P_{tot}	$T_C=25^\circ C, T_J=175^\circ C$	119	W
Junction Temperature	T_J	Continuous	-40...175	$^\circ C$
Case & Storage Temperature	$T_C, T_{storage}$	Continuous	-40...150	$^\circ C$

1200V SiC Full-Bridge Module

GCMX080A120B2H1P

Static Electrical Characteristics, at $T_J=25^\circ\text{C}$, unless otherwise specified

Characteristics	Symbol	Conditions	Values			Unit
			min.	typ.	max.	
Drain-Source Breakdown Voltage	BV_{DSS}	$V_{GS}=0V, I_D=1mA$	1200	-	-	V
Zero Gate Voltage Drain Current	I_{DSS}	$V_{DS}=1200V, V_{GS}=0V$	-	0.1	1	μA
		$V_{DS}=1200V, V_{GS}=0V, T_J=150^\circ\text{C}$	-	1	100	
Gate-Source Leakage Current	I_{GSS+}	$V_{GS}=20V, V_{DS}=0V$	-	10	1000	nA
	I_{GSS-}	$V_{GS}=-5V, V_{DS}=0V$	-	-10	-1000	
Gate Threshold Voltage	$V_{GS(th)}$	$V_{GS}=V_{DS}, I_D=10mA$	1.8	3.1	4	V
		$V_{GS}=V_{DS}, I_D=10mA, T_J=150^\circ\text{C}$	-	2.2	-	
Drain-Source On-Resistance	$R_{DS(on)^*}$	$V_{GS}=20V, I_D=20A$	-	77	100	m Ω
		$V_{GS}=20V, I_D=10A$	-	71	-	
		$V_{GS}=20V, I_D=20A, T_J=150^\circ\text{C}$	-	130	-	
Transconductance	g_{fs}	$V_{DS}=20V, I_D=20A$	-	8.3	-	S
		$V_{DS}=20V, I_D=20A, T_J=150^\circ\text{C}$	-	8.3	-	
Internal Gate Resistance	$R_{G(int)}$	$f=1MHz, V_{AC}=25mV, D-S$ Short	-	3.1	-	Ω

* $R_{DS(on)}$ including package resistance

AC Electrical Characteristics, at $T_J=25^\circ\text{C}$, unless otherwise specified

Characteristics	Symbol	Conditions	Values			Unit
			min.	typ.	max.	
Input Capacitance	C_{ISS}	$V_{GS}=0V$	-	1362	-	pF
Output Capacitance	C_{OSS}	$V_{DS}=800V$	-	152	-	
Reverse Transfer Capacitance	C_{RSS}	$f=200kHz$	-	9	-	
Coss Stored Energy	E_{OSS}^{**}	$V_{ac}=25mV$	-	55	-	μJ
Turn-On Switching Energy	E_{ON}	$T_J=25^\circ\text{C}$	-	242	-	μJ
		$T_J=125^\circ\text{C}$	-	333	-	
		$T_J=150^\circ\text{C}$	-	365	-	
Turn-Off Switching Energy	E_{OFF}	$T_J=25^\circ\text{C}$	-	2	-	
		$T_J=125^\circ\text{C}$	-	2	-	
		$T_J=150^\circ\text{C}$	-	2	-	
Turn-On Delay Time	$t_{D(on)}$	$V_{DD}=600V, I_{DS}=20A,$ $R_{G(ext)}=6.8\Omega, V_{GS}=-5V/20V,$ $L=975\mu\text{H}$	-	10	-	ns
Rise Time	t_R		-	3	-	
Turn-Off Delay Time	$t_{D(off)}$		-	18	-	
Fall Time	t_F		-	4	-	
Total Gate Charge	Q_G		$V_{DD}=800V, I_{DS}=20A$	-	56	
Gate to Source Charge	Q_{GS}	$V_{GS}=-5/20V$	-	22	-	
Gate to Drain Charge	Q_{GD}		-	11	-	

** E_{OSS} is calculated from C_{OSS} curve

1200V SiC Full-Bridge Module

GCMX080A120B2H1P

Freewheeling Diode Characteristics, at $T_J=25^\circ\text{C}$, unless otherwise specified

Characteristics	Symbol	Conditions	Values			Unit
			min.	typ.	max.	
Diode Forward Voltage	V_{SD}	$V_{GS}=-5\text{V}, I_S=20\text{A}$	-	4.2	-	V
		$V_{GS}=-5\text{V}, I_S=20\text{A}, T_J=150^\circ\text{C}$	-	3.6	-	
Reverse Recovery Time	t_{RR}	$T_J=25^\circ\text{C}$ $I_S=20\text{A},$ $V_R=600\text{V},$ $V_{GS}=-5\text{V},$ $di/dt=13.7\text{A/ns}$	-	10	-	ns
Reverse Recovery Charge	Q_{RR}		-	394	-	nC
Peak Reverse Recovery Current	I_{RRM}		-	77	-	A
Reverse Recovery Energy	E_{RR}	$T_J=25^\circ\text{C}$	-	82	-	μJ
		$T_J=125^\circ\text{C}$	-	245	-	
		$T_J=150^\circ\text{C}$	-	305	-	

Thermal and Package Characteristics, at $T_J=25^\circ\text{C}$, unless otherwise specified

Characteristics	Symbol	Conditions	Values			Unit
			min.	typ.	max.	
Thermal resistance, junction-case	R_{thJC}		-	1.07	1.26	$^\circ\text{C/W}$
Mounting torque	M_d	M4-0.7 screws	-	2.00	2.3	N-m
Press fit pin PCB end hole diameter			0.99	-	1.09	mm
Press fit pin PCB hole drill diameter			1.12	1.15	-	mm
Press fit pin PCB hole copper thickness			25	-	50	μm
Package weight	W_t		-	40	-	g
Isolation voltage	V_{ISOL}	$I_{ISOL} < 1\text{mA}, 50/60\text{ Hz}, 1\text{ min}$	2500	-	-	V

NTC Characteristics, at $T_J=25^\circ\text{C}$, unless otherwise specified

Characteristics	Symbol	Conditions	Values			Unit
			min.	typ.	max.	
Rated resistance	R_{NTC}	$T_{NTC} = 25^\circ\text{C}$	-	5.0	-	k Ω
Resistance tolerance	$\Delta R/R$		-5	-	5	%
Beta Value ($T_2 = 50^\circ\text{C}$)	$\beta_{25/50}$		-	3380	-	k
Beta Value ($T_2 = 80^\circ\text{C}$)	$\beta_{25/80}$		-	3440	-	k
Power dissipation	P_{MAX}	$T_{NTC} = 25^\circ\text{C}$	-	-	50	mW

Typical Performance

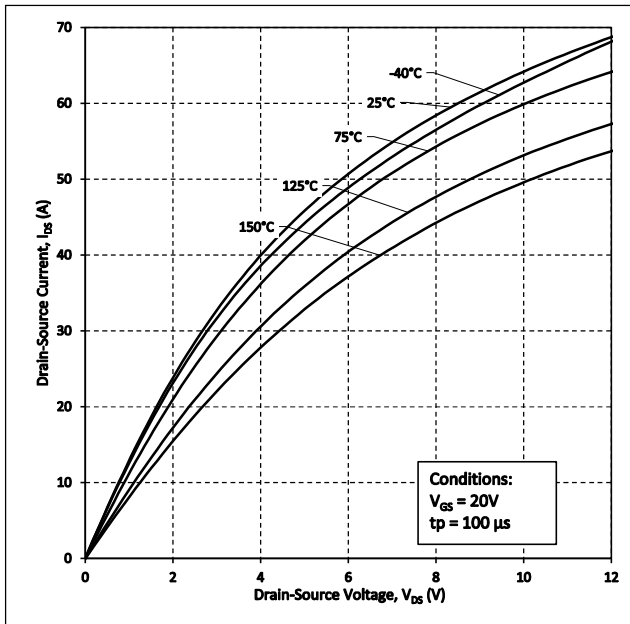

Figure 1. Output Characteristics for Various Temperatures

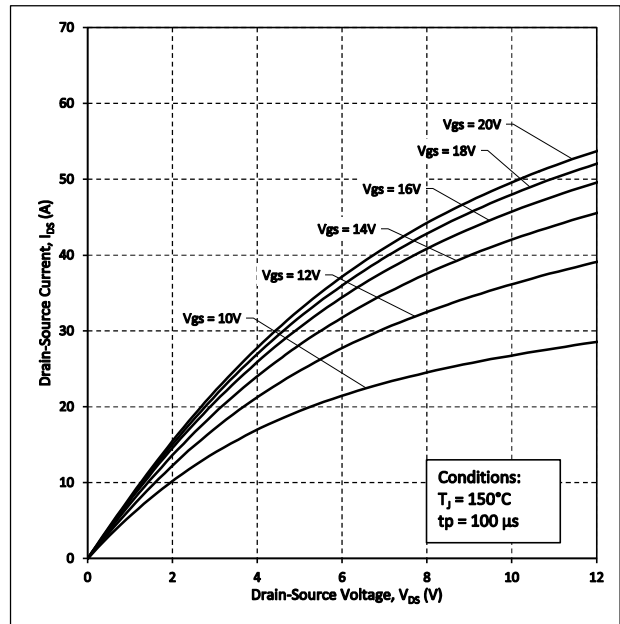

Figure 2. Output Characteristics $T_J = 150^\circ C$

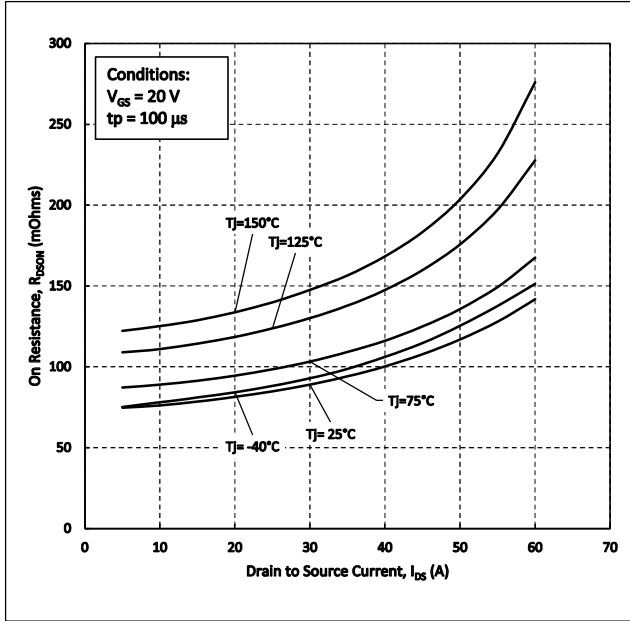

Figure 3. On-Resistance vs. Drain Current For Various Temperatures

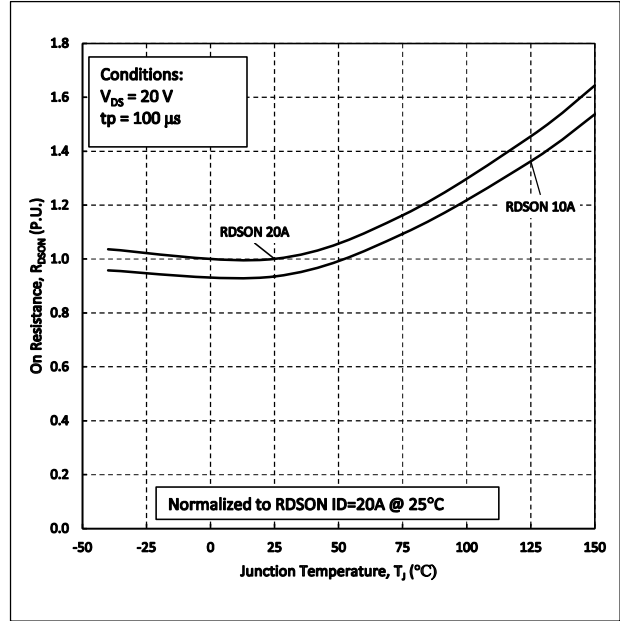

Figure 4. Normalized On-Resistance vs. Temperature

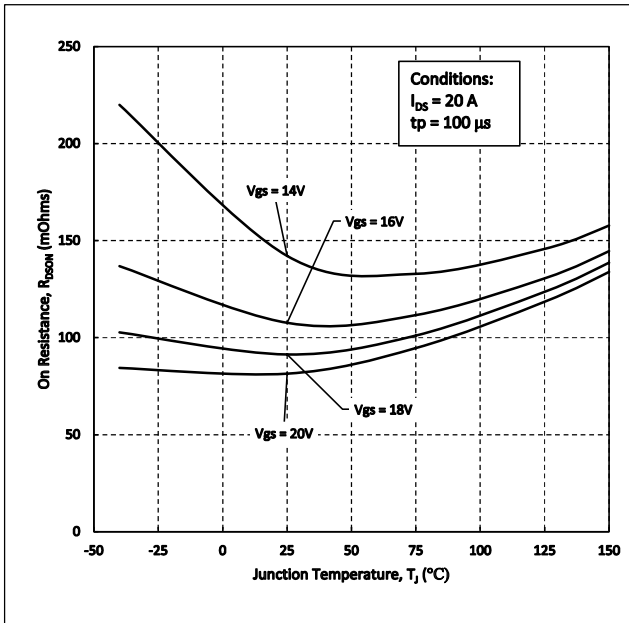

Figure 5. On-Resistance vs. Temperature For Various Gate Voltages

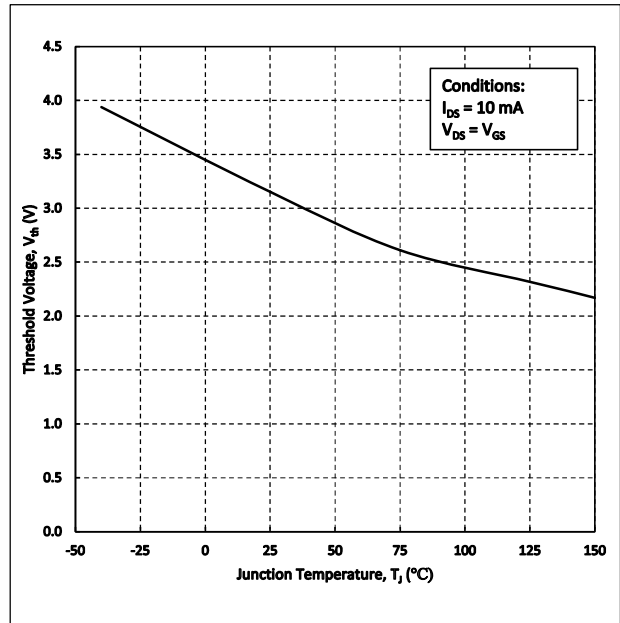

Figure 6. Threshold Voltage vs. Temperature

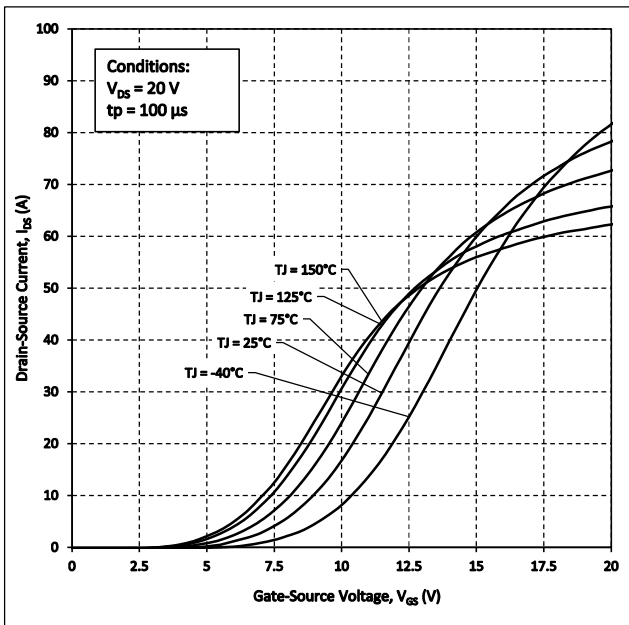

Figure 7. Transfer Characteristic for Various Junction Temperatures

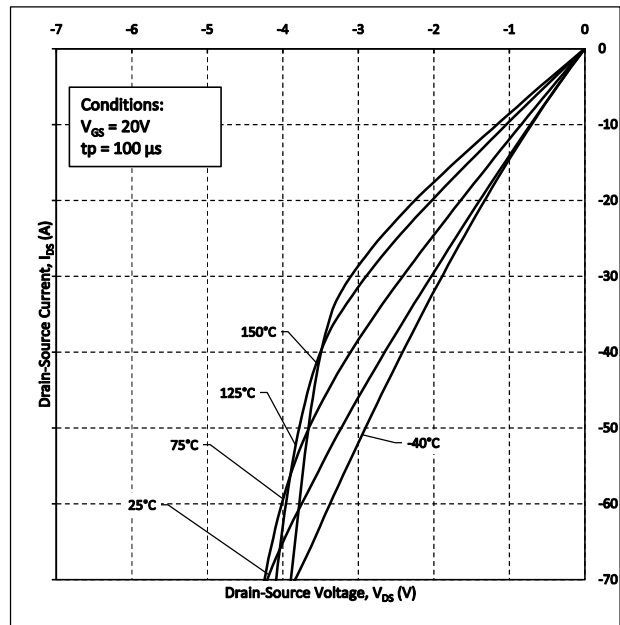

Figure 8. 3rd Quadrant Characteristics at $V_{GS} = 20V$

1200V SiC Full-Bridge Module

GCMX080A120B2H1P

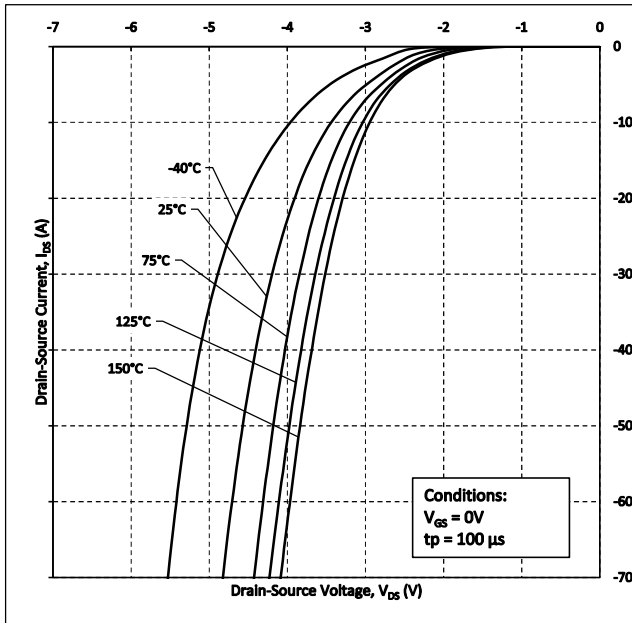

Figure 9. Body Diode Characteristics at $V_{GS} = 0V$

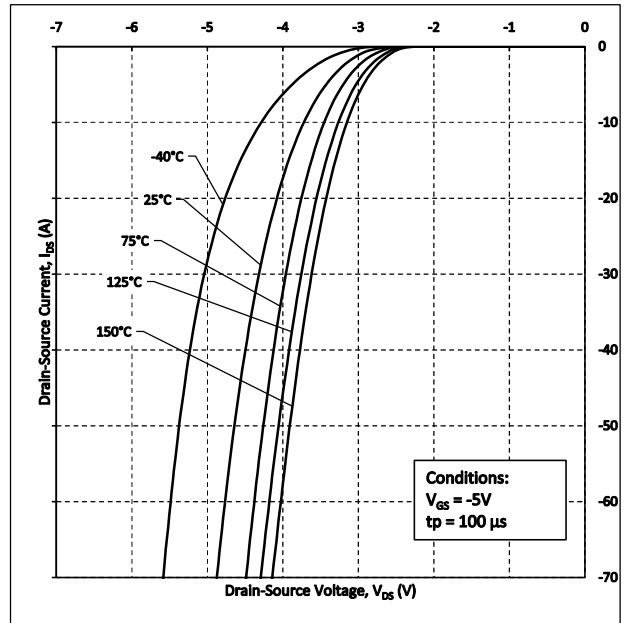

Figure 10. Body Diode Characteristics at $V_{GS} = -5V$

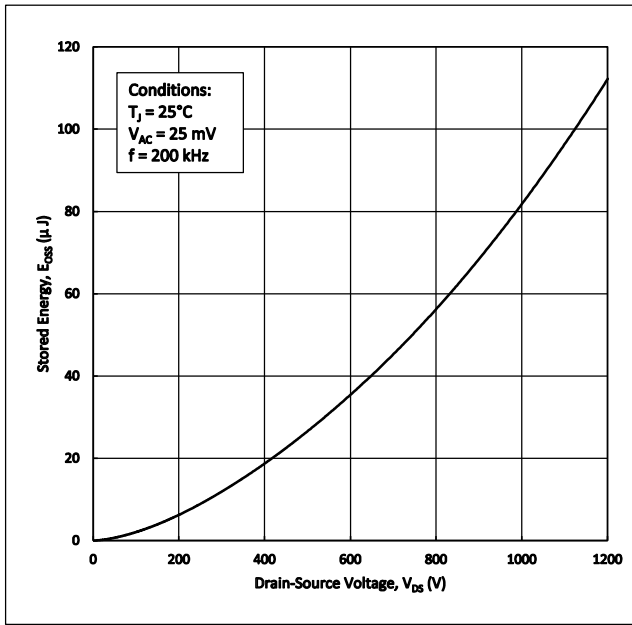

Figure 11. Output Capacitor Stored Energy

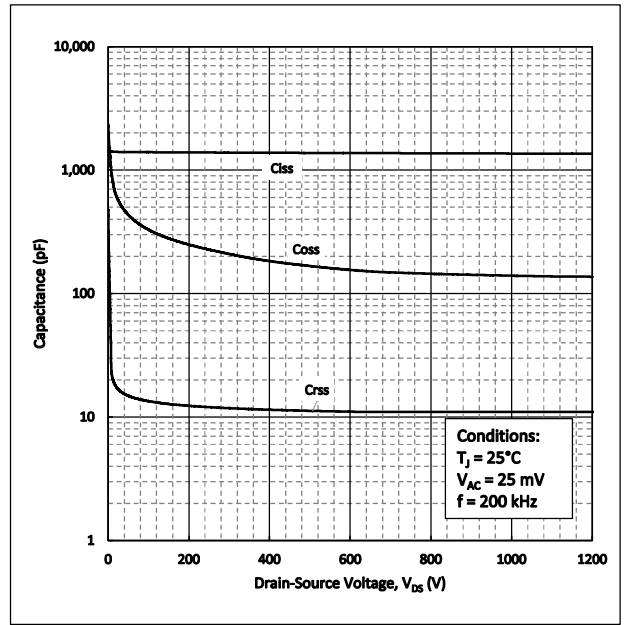

Figure 12. Capacitance vs. Drain-Source Voltage

1200V SiC Full-Bridge Module

GCMX080A120B2H1P

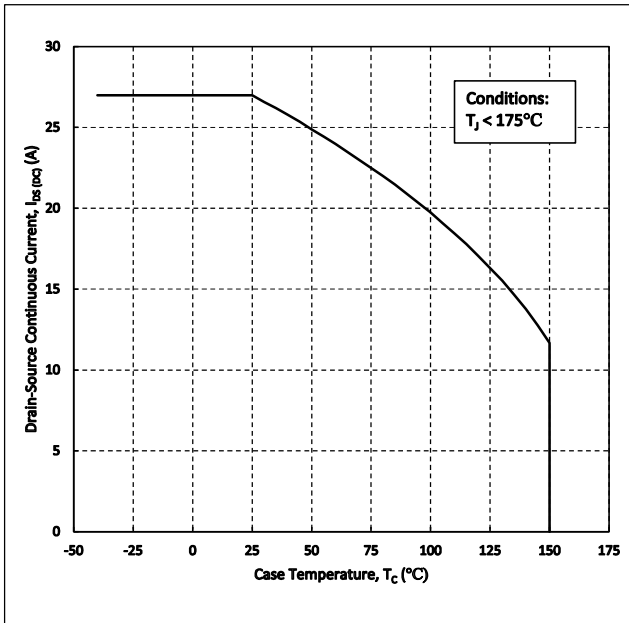

Figure 13. Continuous Drain Current Derating vs. Case Temperature

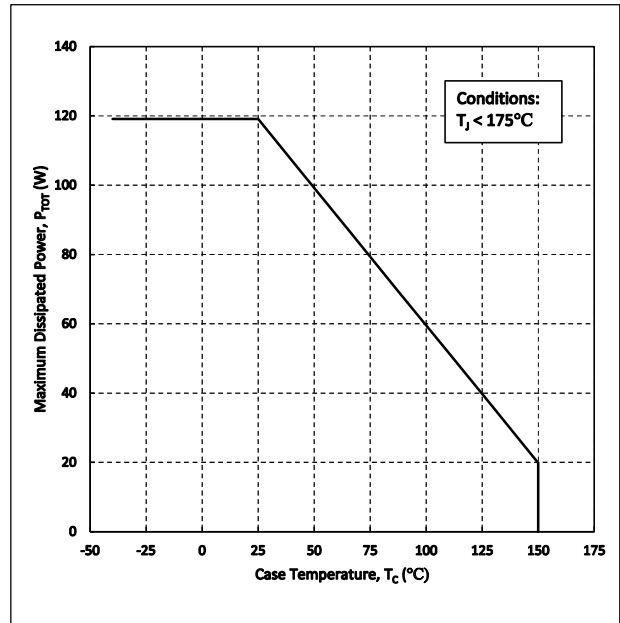

Figure 14. Maximum Power Dissipation Derating vs. Case Temperature

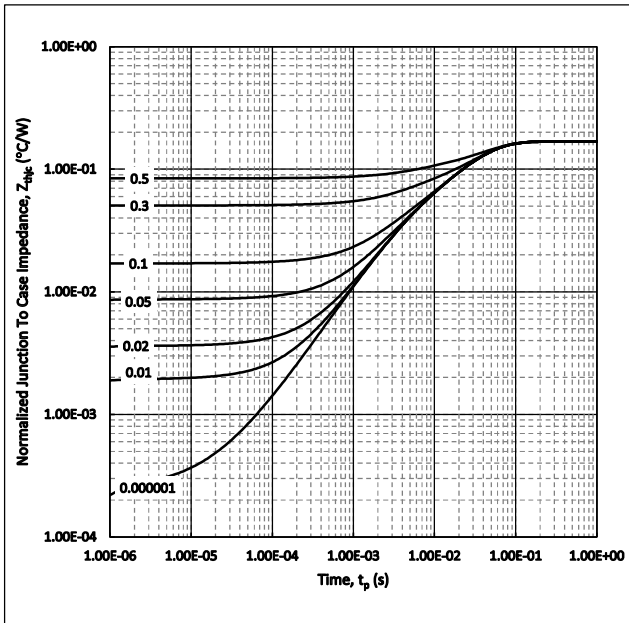

Figure 15. Transient Thermal impedance (Junction to Case)

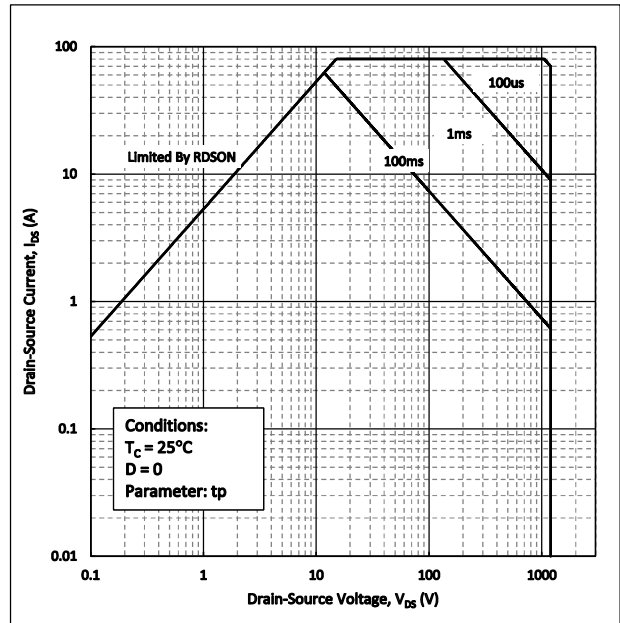

Figure 16. Safe Operating Area

1200V SiC Full-Bridge Module

GCMX080A120B2H1P

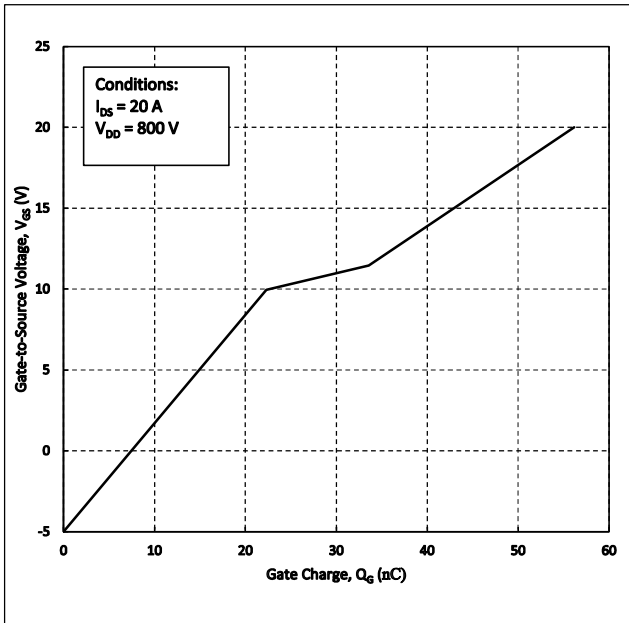

Figure 17. Gate Charge Characteristics

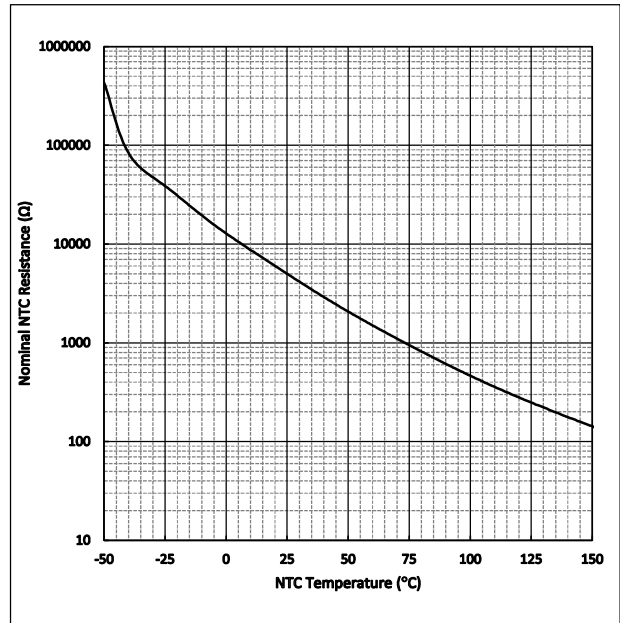

Figure 18. Nominal NTC Resistance vs. Temperature

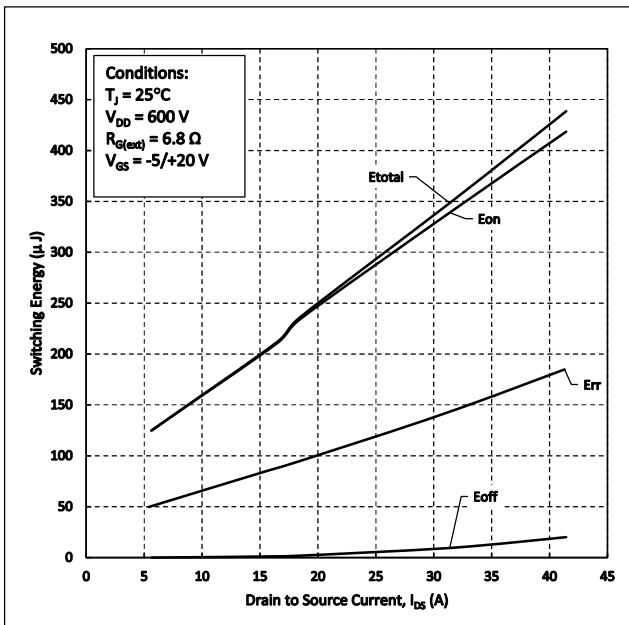

Figure 19. Clamped Inductive Switching Energy vs. Drain Current (600V)

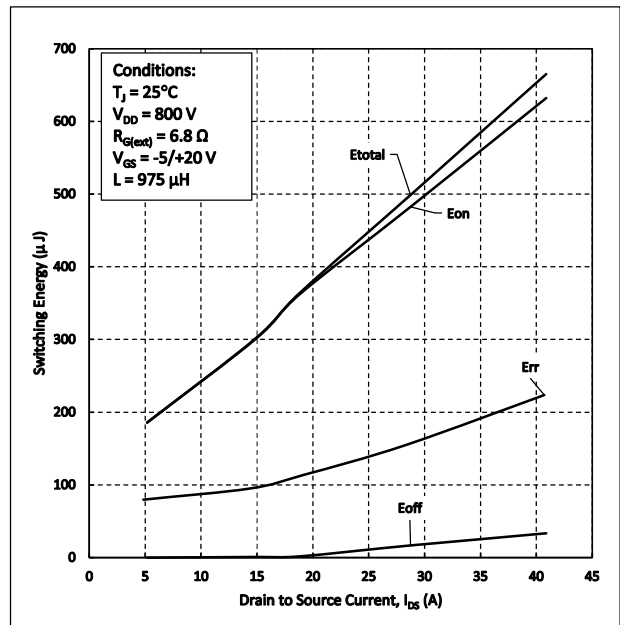

Figure 20. Clamped Inductive Switching Energy vs. Drain Current (800V)

1200V SiC Full-Bridge Module

GCMX080A120B2H1P

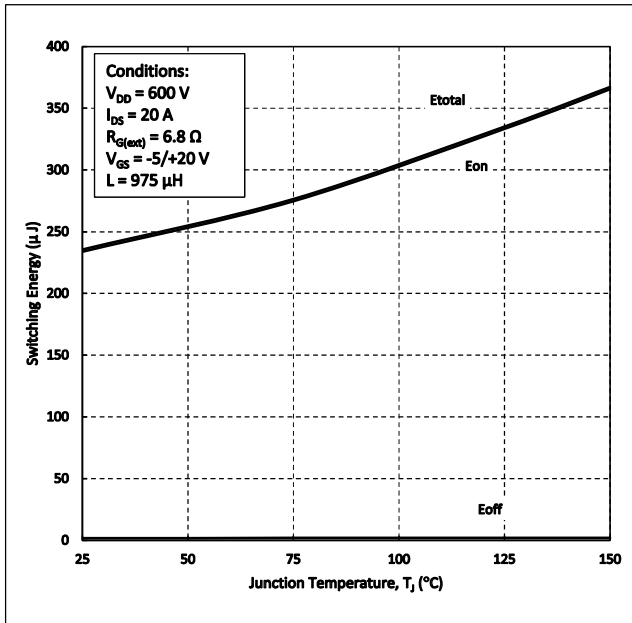

Figure 21. Clamped Inductive Switching Energy vs. Temperature

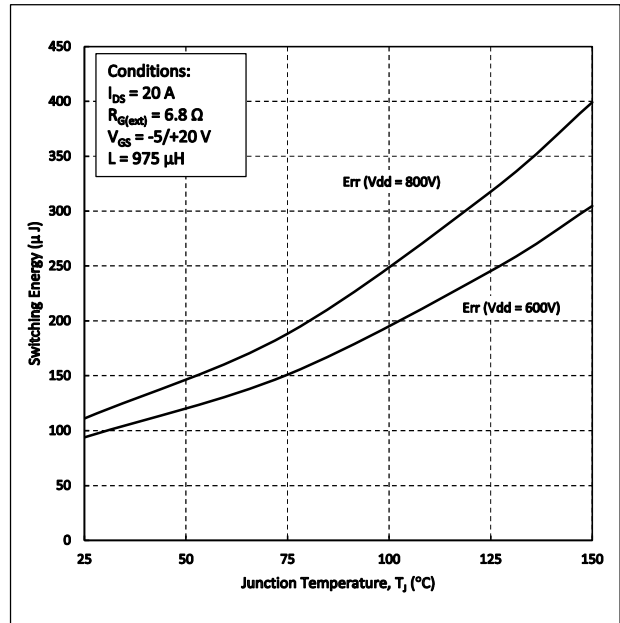

Figure 22. Reverse Recovery Energy vs. Temperature

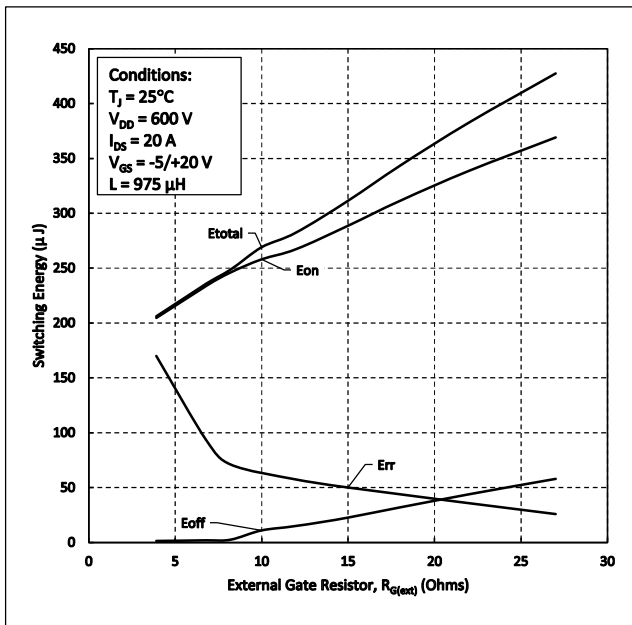

Figure 23. Clamped Inductive Switching Energy vs. $R_{G(ext)}$

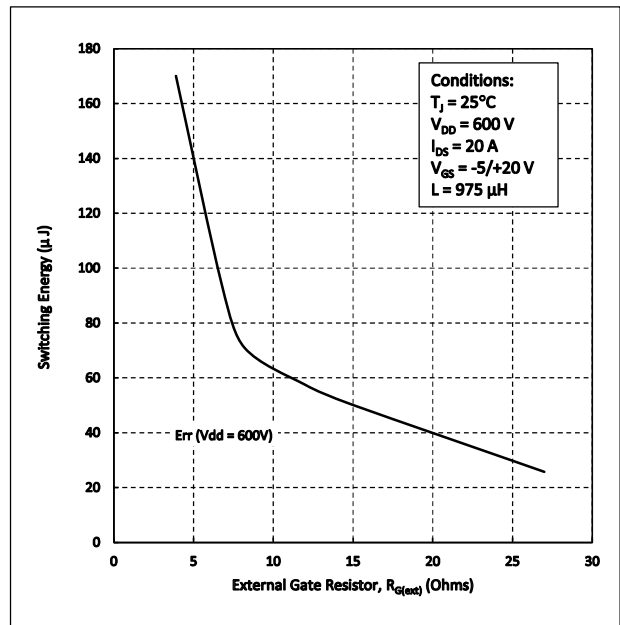

Figure 24. Reverse Recovery Energy vs. $R_{G(ext)}$

1200V SiC Full-Bridge Module

GCMX080A120B2H1P

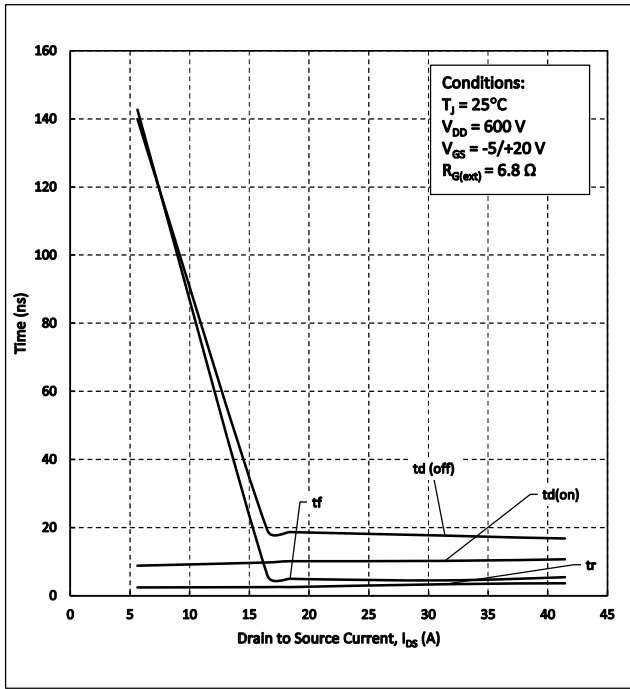

Figure 25. Switching Times vs. Drain Current

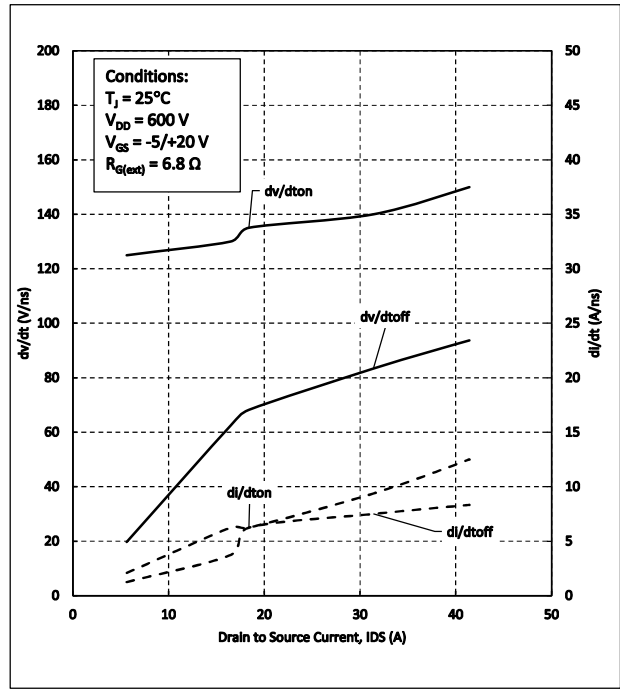

Figure 26. dv/dt and di/dt vs. Source Current

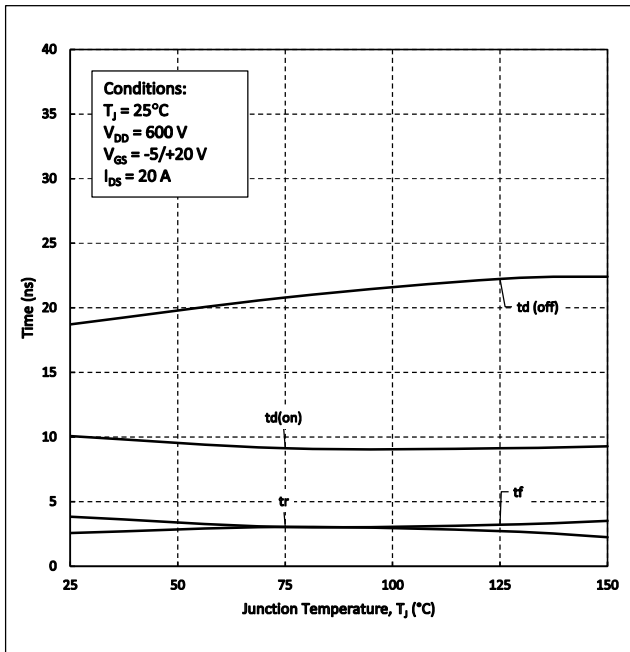

Figure 27. Switching Times vs. Temperature

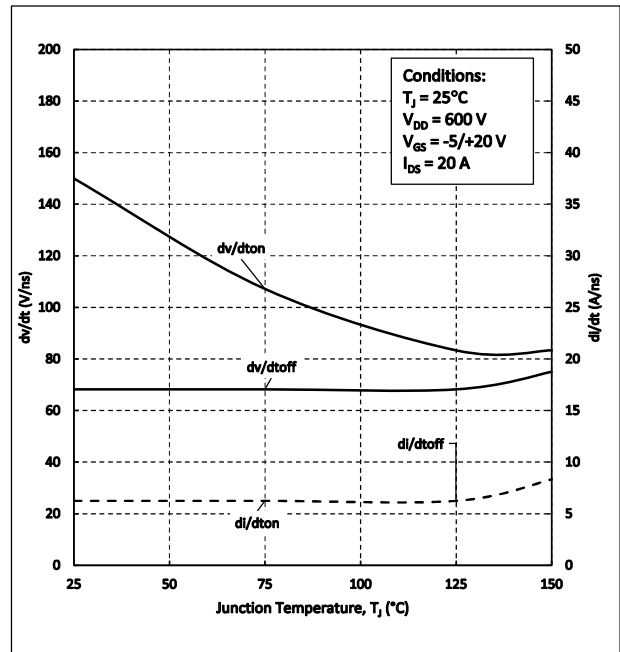

Figure 28. dv/dt and di/dt vs. Temperature

1200V SiC Full-Bridge Module

GCMX080A120B2H1P

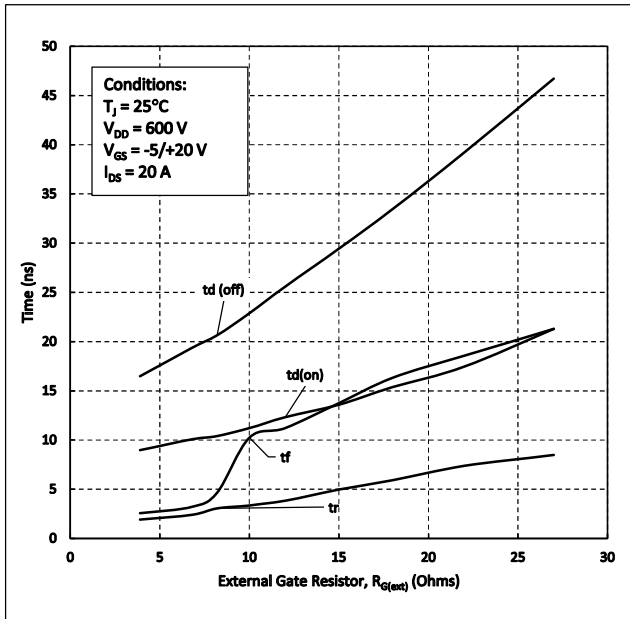

Figure 29. Switching Times vs. $R_{G(\text{ext})}$

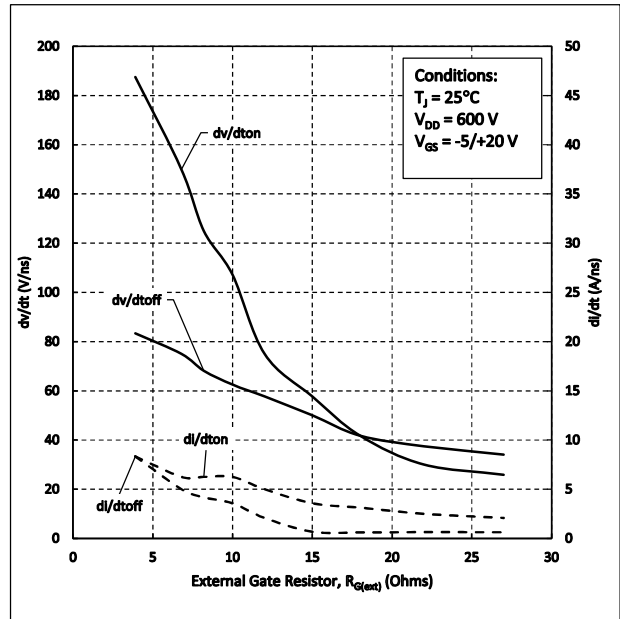

Figure 30. dv/dt and di/dt vs. $R_{G(\text{ext})}$

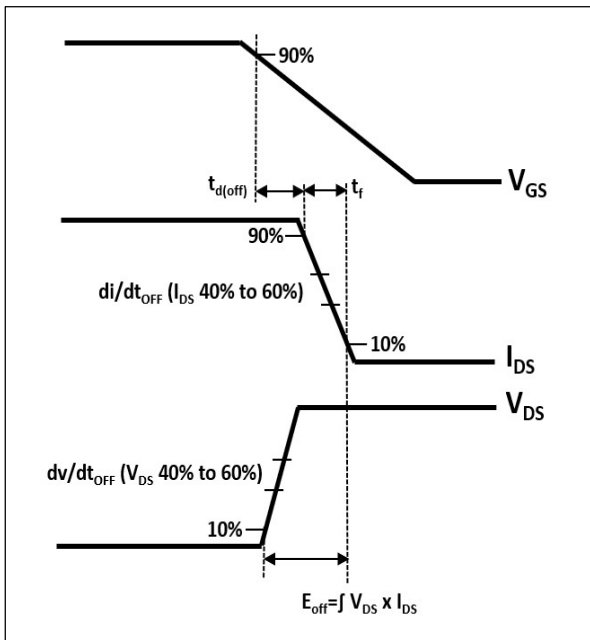

Figure 31. Turn-off Transient Definitions

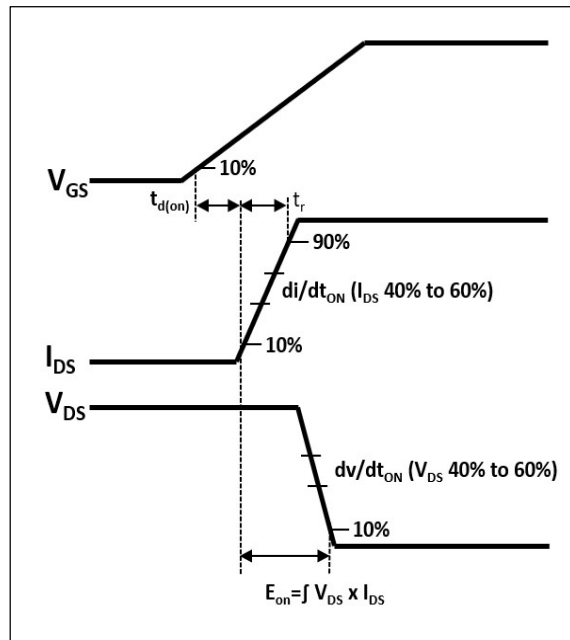

Figure 32. Turn-on Transient Definitions

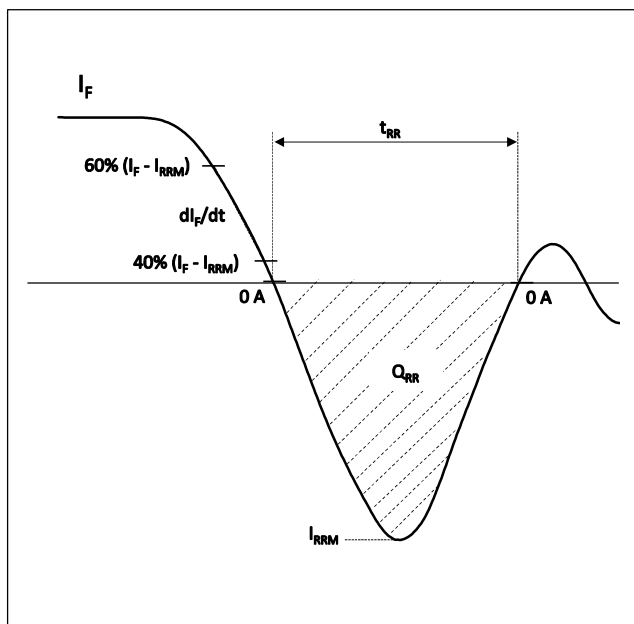
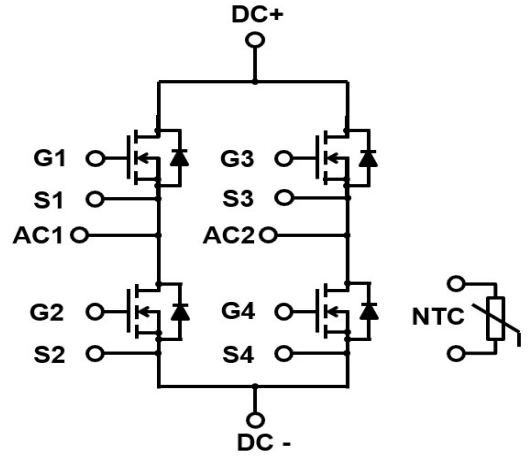
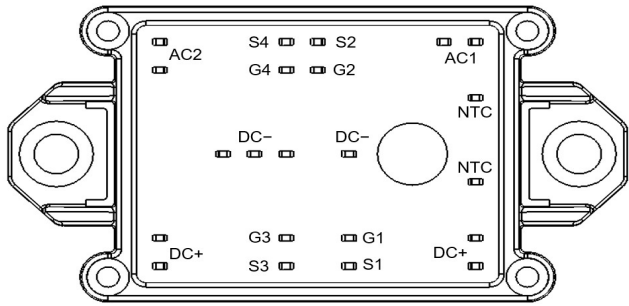

Figure 33. Reverse Recovery Definitions

1200V SiC Full-Bridge Module

GCMX080A120B2H1P

Pinout and Circuit Diagram



Package Dimensions (mm) for B2

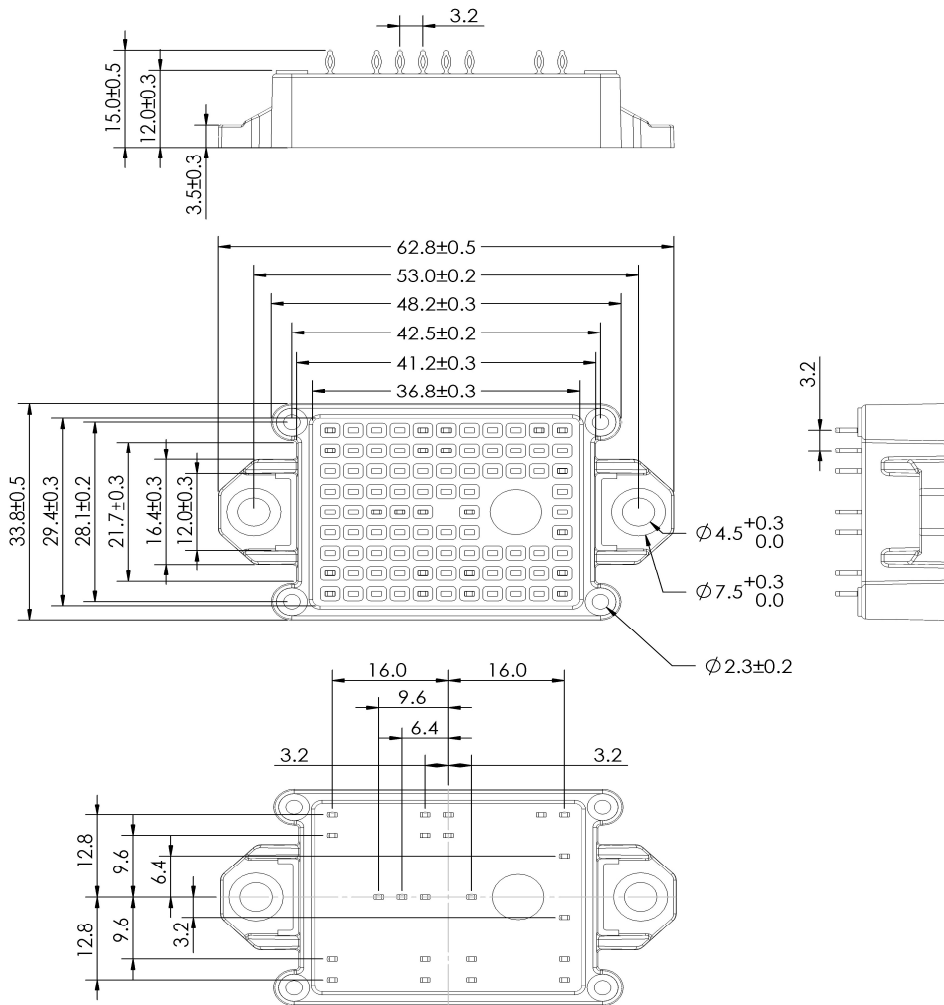

1200V SiC Full-Bridge Module

GCMX080A120B2H1P

Revision History		
Date	Revision	Notes
10/12/2023	1.0	Initial Release

Notes

RoHS Compliance

The levels of RoHS restricted materials in this product are below the maximum concentration values (also referred to as the threshold limits) permitted for such substances, or are used in an exempted application, in accordance with EU Directive 2011/65/EC (RoHS2), as implemented March, 2013. RoHS Declarations for this product can be obtained from the Product Documentation sections of www.SemiQ.com.

REACH Compliance

REACH substances of high concern (SVHC) information is available for this product. Since the European Chemicals Agency (ECHA) has published notice of their intent to frequently revise the SVHC listing for the foreseeable future, please contact our office at SemiQ Headquarters in Lake Forest, California to insure you get the most up-to-date REACH SVHC Declaration. REACH banned substance information (REACH Article 67) is also available upon request.

SemiQ Inc., reserves the right to make changes to the product specifications and data in this document without notice. SemiQ products are sold pursuant to SemiQ's terms and conditions of sale in place at the time of order acknowledgement.

This product has not been designed or tested for use in, and is not intended for use in, applications implanted into the human body nor in applications in which failure of the product could lead to death, personal injury or property damage, including but not limited to equipment used in the operation of nuclear facilities, life-support machines, cardiac defibrillators or similar emergency medical equipment, aircraft navigation or communication or control systems, or air traffic control.

SemiQ makes no warranty, representation or guarantee regarding the suitability of its products for any particular purpose, nor does SemiQ assume any liability arising out of the application or use of any product or circuit, and specifically disclaims any and all liability, including without limitation special, consequential or incidental damages. Buyer is responsible for its products and applications using SemiQ products.

To obtain additional technical information or to place an order for this product, please contact us. The information in this datasheet is provided by SemiQ. SemiQ reserves the right to make changes, corrections, modifications, and improvements of datasheet without notice.